



FOOD INDUSTRY INDUSTRIAL HEALTHCARE

# ALYGER<sup>®</sup>

DISPOSABLE ITEMS FOR PERSONAL PROTECTION  
AND EQUIPMENT FOR INDUSTRIAL SAFETY

**WE ARE MANUFACTURER!**



HEAD  
PROTECTION



HAND AND ARM  
PROTECTION



FOOT  
PROTECTION



BODY  
PROTECTION



PROTECTION  
FOR EQUIPMENT



## ABOUT US?

Grupo Alyger S.A. de C.V. we are a Mexican company dedicated to the manufacture and sale of disposable articles for safety and personal hygiene with applications in industrial, medical, food and consumer companies, among others.

Our priority is to provide the market with the best options in articles for safety and hygiene. We offer personalized attention, handling articles of the best quality, development of special projects and excellent response capacity / delivery times.

## PRESENCE

Our products have had excellent performance(rating) in more than 10 countries in Central and South America, in addition to the United States and Canada.

## DELIVERY POLICIES

For national shipments it is carried out the same day by ordering before the 12 hours.

## MISION

Offer and provide articles that guarantee safety and hygiene of users and products in the food industry, industrial, medical and consumer areas.

## VISION

Be a leading company in safety and hygiene products in Mexico, increasing our presence internationally focused on the development and innovation of products and services.

## VALUES

- Health (hygiene)
- Prevention
- Honesty
- Responsibility
- Respect
- Service Actitud
- Loyalty

## CERTIFICATION



## PROTECTION ZONE



HEAD PROTECTION



HAND AND ARM PROTECTION



FOOT PROTECTION



BODY PROTECTION



PROTECTION FOR EQUIPMENT

## APPLICATIONS



FOOD INDUSTRY



INDUSTRIAL



HEALTHCARE



FOOD MANAGEMENT



CUT PROTECTION



WATERPROOF



AVERAGE WATERPROOF



GENERAL USAGE



ANIMAL PROTECTION



CLEANING



MAINTENANCE



COSMETICS



V RAY RESISTANCE



COLD RESISTANCE



SKILL



MANAGEMENT OF OIL/FATS



HEAT RESISTANCE



HIGH VISIBILITY



AGAINST STATIC



MANAGEMENT OF GLASS/ALUMINUM

## USES



## SAFETY AND HYGIENE

---

• Facemasks	4
• Bouffants	8
• Hairs nets	12
• Gowns/ Uniforms	13
• Spa clothing	19
• Coveralls	21
• Shoe covers	23
• Sleeves	27
• Aprons	28
• Lumbar protection	34
• Visual protection	35
• Hearing protection	37
• Protection for feet / Leg	38

## SAFETY GLOVES

---

• Disposable gloves	41
• Synthetic gloves	44
• Knitted gloves	47
• Coated knitted gloves	49
• Cut protection gloves	52
• Leather gloves	54
• Temperature manage gloves	55

## ROAD SAFETY

---

• Cones	57
• Vests	58
• Tapes	59
• Helmets	60



**ALYGER**<sup>®</sup>  
Safety and Hygiene





## SINGLE FACE MASK



Disposable face mask manufactured with nonwoven, side sealed, with 65cm wound elastic. Free of seams.

**Measurements:** width 17.5cm x 12.5cm height

**Presentation:** case with 1,500 pieces (10 packages of 150 pieces).

ITEM	PART NUMBER	COLOR	LAYERS
LCP1B	CS-1711-B		1
LCP2B	CS-1712-B		2
LCP2A	CS-1712-A		2
LCP2V	CS-1712-V		2
LC-2730-A	CS-2730-A		2

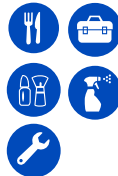

CS-1712-B

CS-1712-A

## EARLOOP FACE MASK 2 LAYER



Earloop facemask 2 layer, disposable, simple, manufactured with nonwoven, elastic to the ears, seam-free.

**Measures: open:** width 17.5cm x 17cm height.

**Close:** width 17.5cm x 9.5cm height.

**Presentation:** case with 3,000 pieces (20 packages of 150 pieces)

\*With elastic fastening to ears. Without nasal adjustment band.

ITEM	PART NUMBER	COLOR
LCP-2515-A	CC-2515-A	
LCP-2515-B	CC-2515-B	
LCP-2515-N	CC-2515-N	

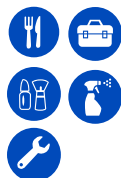

## EARLOOP FACE MASK 1 SMS LAYER



Disposable earloop face masks 1 SMS layer, with nose adjustment, elastic to the ears, free of seams.

**Measures:** open: width 17.5cm x 17cm height.  
Close: width 17.5cm x 9.5cm height.

**Presentation:** case with 2,000 pieces (40 packages of 50 pieces).

\* With elastic fastening to ears.

ITEM	PART NUMBER	COLOR	ADJUSTMENT
LCP-1920-A	CP-1920-A	Blue	✓
LCP-1920-B	CP-1920-B	White	✓
LCP-1920-N	CP-1920-N	Black	✓
LCP-1915-A	CP-1915-A	Blue	-
LCP-1915-B	CP-1915-B	White	-
LCP-1915-N	CP-1915-N	Black	-

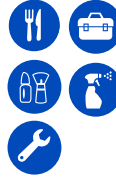

## DISPOSABLE FACE MASK



Earloop face mask 2 layer, with nose adjustment, elastic to de ears, fee of seams.

**Measures:** open: width 17.5cm x 17cm height.  
Close: width 17.5cm x 9.5cm height.

**Presentation:** case with 2,000 pieces (40 packages of 50 pieces).

ITEM	PART NUMBER	NASAL ADJUSTMENT	COLOR
LCP-2520-B	CC-2520-B	✓	White
LCP-2520-A	CC-2520-A	✓	Blue
LCP-2520-N	CC-2520-N	✓	Orange



Elastic to ears



## COMPLETE FACE MASK



Earloop face mask 3 layer (2 layers of Polypropylene and 1 filter mid melt blown). free of seams.

**Measures:** open: width 17.5cm x 17cm height.  
Close: width 17.5cm x 9.5cm height.

**Presentation:** case with 2,000 pieces (40 packages of 50 pieces).

CLAVE	PART NUMBER	SUJECIÓN	COLOR	NASAL ADJUSTMENT
LCCENB	CP-3770-B	Elástico a la nuca	<input type="checkbox"/>	✓
LCCENA	CP-3770-A	Elástico a la nuca	<input type="checkbox"/>	✓
LCCCB	CP-3750-B	Cintillas/Tiras de amarre	<input type="checkbox"/>	✓
LCCCA	CP-3750-A	Cintillas/Tiras de amarre	<input type="checkbox"/>	✓



LCP-3720-B

CLAVE	PART NUMBER	SUJECIÓN	COLOR	NASAL ADJUSTMENT
LCP-3720-B	LCP-3720-B	Elástico a oídos	<input type="checkbox"/>	✓
LCP-3720-A	LCP-3720-A	Elástico a oídos	<input type="checkbox"/>	✓
LCP-3715-B	LCP-3725-B	Elástico a oídos	<input type="checkbox"/>	-
LCP-3715-A	LCP-3725-A	Elástico a oídos	<input type="checkbox"/>	-



LCP-3720-A



Elastic to the ears



CP-3770-B



CP-3750-B





## SHELL TYPE FACE MASK



Face mask for powder and non-toxic particles.

**Characteristics / Advantages:** Made of polypropylene, elastic band at the nape of the neck, metal clip for nose fit, cool and comfortable. It allows a comfortable and fluid breathing. Adjusts to the outline of the face.

**Presentation:** package of 50 pieces.

ITEM	PART NUMBER	COLOR
LCBC	CBC-1001	<input type="checkbox"/>

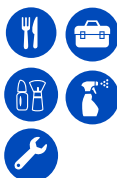

## RESPIRATOR N95



Recommended for respiratory protection in atmospheres with dust or non oil haze.

**Characteristics/ Advantages:** Made of polypropylene. Elastic bands at the nape, metal clip for nose adjustment, internal sweat band, contour with edging that adjusts to the outline of the face. Cool and comfortable. It allows a comfortable and fluid breathing.

**Presentation:** case with 400 pieces (20 boxes of 20 pieces).

ITEM	PART NUMBER
LC-2710	CR-2710

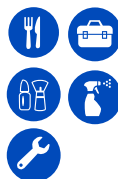

## BEARD MASK



Disposable beard mask, manufactured with nonwoven and with a comfortable elastic band that fixes at the nape. Latex free.

**Presentation:** case with 1,000 pieces (10 packages of 100 pieces).

ITEM	PART NUMBER	COLOR	GRAMMAGE
LCBD	CB-1811-B	<input type="checkbox"/>	11 g
LCBD20	CB-1811-B	<input type="checkbox"/>	20 g

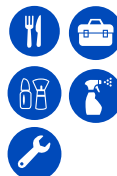



# PLEATED BOUFFANT



Disposable pleated cap, manufactured with nonwoven. Latex free.

**Presentation:** case with 1,000 pieces (10 packages of 100pieces).

ITEM	PART NUMBER	COLOR	ELASTIC	WEIGHT	MEASURE
LGBP2-L	GP-5121-B	<input type="checkbox"/>	DOBLE	LIGERA	21"
LGBP2-M	GP-5221-B	<input type="checkbox"/>	DOBLE	MEDIA	21"
LGBP2-P	GP-5321-B	<input type="checkbox"/>	DOBLE	PESADA	21"
LGBP2-L24	GP-5124-B	<input type="checkbox"/>	DOBLE	LIGERA	24"
LGAP2-L	GP-5121-A	<input checked="" type="checkbox"/>	DOBLE	LIGERA	21"
LGAP2-M	GP-5221-A	<input checked="" type="checkbox"/>	DOBLE	MEDIA	21"
LGAP2-L24	GP-5124-A	<input checked="" type="checkbox"/>	DOBLE	LIGERA	24"
LGVP	GP-5121-1XV	<input checked="" type="checkbox"/>	SENCILLO	LIGERA	21"
LGAMP	GP-5121-1XAM	<input checked="" type="checkbox"/>	SENCILLO	LIGERA	21"
LGRP	GP-5121-1XR	<input checked="" type="checkbox"/>	SENCILLO	LIGERA	21"
LGMP	GP-5121-1XM	<input checked="" type="checkbox"/>	SENCILLO	LIGERA	21"
LGNP	GP-5121-1XNA	<input checked="" type="checkbox"/>	SENCILLO	LIGERA	21"
LGRP2-L	GP-5121-R	<input checked="" type="checkbox"/>	DOBLE	LIGERA	21"
LGNP2-L	GP-5121-N	<input checked="" type="checkbox"/>	DOBLE	LIGERA	21"
LGBP1-21	GP-5121-1B	<input type="checkbox"/>	SENCILLO	LIGERA	21"
LGBP-18	GP-5118-1XB	<input type="checkbox"/>	SENCILLO	LIGERA	18"
LGBP	GP-5121-1XB	<input type="checkbox"/>	SENCILLO	LIGERA	21"

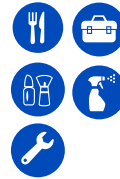

Elastic simple

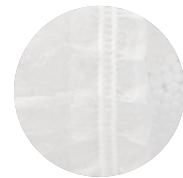

Elastic double



Ligera  
GP-5121-B



Media  
GP-5221-B



Pesada  
GP-5321-B



Negro  
GP-5121-N



Morado  
GP-5121-1XM



Verde  
GP-5121-1XV



Amarillo  
GP-5121-1XAM



Azul  
GP-5121-A



Roja  
GP-5121-1XR



Naranja  
GP-5121-1XNA

CAPS / BOUFFANTS

LICOMS



## CIRCULAR BOUFFANT



Disposable cap mushroom type knitted, manufactured with nonwoven.

**Presentation:** case with 1,000 pieces (10 packages of 100 pieces).

ITEM	PART NUMBER	COLOR	MEASURE	GRAMMAGE
LGBC	GC-2110-B	<input type="checkbox"/>	21"	10g
LGAC	GC-2110-A	<input checked="" type="checkbox"/>	21"	10g
LGVC	GC-2110-V	<input checked="" type="checkbox"/>	21"	10g
LGBC20	GC-2120-B	<input type="checkbox"/>	21"	20g
LGAC20	GC-2120-A	<input checked="" type="checkbox"/>	21"	20g
LGVC20	GC-2120-V	<input checked="" type="checkbox"/>	21"	20g
LGBC24	GC-2410-B	<input type="checkbox"/>	24"	10g
LGAC24	GC-2410-A	<input checked="" type="checkbox"/>	24"	10g



## SURGEON HAT



Disposable hat made of SMS, with straps to adjust.

**Presentation:** case with 1,000 pieces (10 packages of 100 pieces).

ITEM	PART NUMBER	COLOR	GRAMMAGE	DETAIL
LGC25-S	GTC-3710	<input checked="" type="checkbox"/>	25G	SEALED
LGC25B-S	GTC-3712	<input type="checkbox"/>	25G	SEALED
LGBCB30	LGC-3715-B	<input type="checkbox"/>	30G	SEWING / WITH BIES
LGCB30	GTC-3715-A	<input checked="" type="checkbox"/>	30G	SEWING / WITH BIES





## DISPOSABLE VENETIAN TYPE BOUFFANT



Disposable hat, manufactured with nonwoven of 25g.

**Presentation:** case with 1,000 pieces (10 packages of 100 pieces).

ITEM	PART NUMBER	COLOR
LGAV25	GTV-3825-A	<input type="checkbox"/>
LGBV25	GTV-3825-B	<input type="checkbox"/>

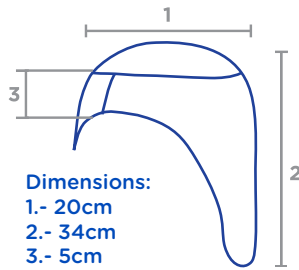
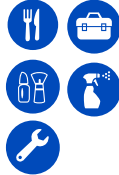

## ESCAFANDRA



Disposable Escafandra, manufactured with nonwoven of 12g.

**Presentation:** case with 1,000 pieces (10 packages of 100 pieces).

CLAVE	NO. DE PARTE	COLOR	GRAMAJE
	ES-3910-A	<input type="checkbox"/>	10g
	ES-3910-B	<input type="checkbox"/>	10g
LESDB12	ES-3912-B	<input type="checkbox"/>	12g
LESDA12	ES-3912-A	<input type="checkbox"/>	12g
	ES-3920-A	<input type="checkbox"/>	20g
	ES-3920-B	<input type="checkbox"/>	20g

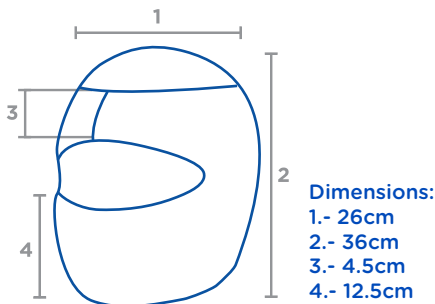
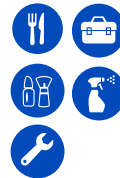



## DISPOSABLE HAIR BAND



Disposable hair band manufactured with nonwoven with straps to adjust.

**Presentation:** package of 10 pieces

ITEM	PART NUMBER	COLOR
LBCA	SBC-3508-A	Blue
LBCB	SBC-3508-B	White



Detail



## POLYETHYLENE BOUFFANT CAP



Disposable bouffant made of transparent polyethylene.

**Presentation:** case with 2,000 pieces (20 packages of 100 pieces).

ITEM	PART NUMBER	SIZE
LGBT	GPT-3418-T	18"





## HONEYCOMB HAIR NET



Hair net made of nylon-polyester.

**Presentation:** case with 1,000 pieces (10 packages of 100 pieces).

ITEM	PART NUMBER	COLOR	MEASURE
LMCC	RP-3621-C	■	21"
LMCB	RP-3621-B	■	21"
LMCN	RP-3621-N	■	21"
LMCC-24	RP-3624-C	■	24"



LMCC



LMCN

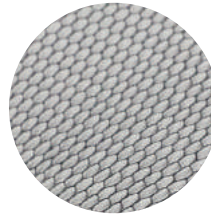

Detail



LMCB

## NYLON HAIR NET



100% nylon hair net.

**Presentation:** case with 1,440 pieces (10 dispensers with 144 pieces).

ITEM	PART NUMBER	COLOR	MEASURE	WEIGHT	DETAIL
LMN	RN-3672-N	■	20"	LIGHT	WITHOUT BIES



LMN



Dispenser

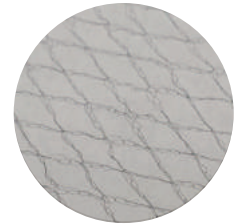

Detail

**Presentation:**

\*Without bies:

Case with 1,440 pieces (10 dispensers with 144 pieces).

\*With bies:

Hoop with 48 pieces.

ITEM	PART NUMBER	COLOR	MEASURE	WEIGHT	DETAIL
LMNG	RN-3673-N	■	21"	HEAVY	WITHOUT BIES
LMNGB	RN-3674	■	21"	HEAVY	WITH BIES



Details

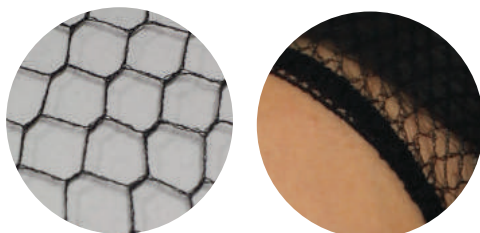

Dispenser



LMNG



## POLYETHYLENE GOWN



Disposable gown manufactured with nonwoven, long sleeves with hole for adjustment to the thumb and tie straps at the waist.

**Measures:** 95cm of width x 120cm of height.

**Presentation:** case with 100 pieces (packaged individually).

ITEM	PART NUMBER	COLOR
LBPADP	BP-1660-A	<input type="checkbox"/>
LBPBDP	BP-1660-B	<input type="checkbox"/>

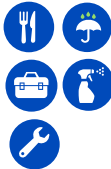

Detail



Fit to thumb



## 4 STRIPE DISPOSABLE GOWN



Disposable gown manufactured with SMS 22g nonwoven, long sleeves with elastic on the cuffs and 4 tie straps (2 at the top and 2 at the middle).

**Measures:** 136cm of width x 98cm of high and sleeves of 60cm.

ITEM	PART NUMBER	COLOR
LBL22B	B4T-1504-L-B	<input type="checkbox"/>

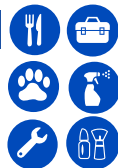

Cuff



Tie Straps





## CROSS DISPOSABLE GOWN



Disposable gown manufactured with nonwoven, long sleeve with elastic on the cuffs, outline and 2 tie straps

Mesures: 136cm of width x 98cm of high and sleeve of 60cm.

Presentation: package of 10 pieces.

ITEM	PART NUMBER	COLOR	GRAMMAGE	DETALLE
LBLCB	BC-1522-1-B	<input type="checkbox"/>	30G	WITH BIES
LBLCB-SB-25	BC-1522-B	<input type="checkbox"/>	25G	SIMPLE
LBLCA-SB-25	BC-1522-A	<input checked="" type="checkbox"/>	25G	SIMPLE
LBLCC-SB-22	BC-1522-C	<input type="checkbox"/>	22G	SIMPLE



LBLCB

LBLCC-SB-22

GOWNS / UNIFORMS

LICOMS



Back Details

Details



Cuff



Tie Straps



Bies



LBLCA-SB-25

## STRAPLESS DISPOSABLE GOWN



Disposable strapless gown manufactured with nonwoven, with elastic in the superior outline for adjustments. This types of gown is recommended for the use of spas, Hotels, among others.

Measures: 75cm of high

ITEM	PART NUMBER	COLOR
LBSPA-3218-A	BS-1518-A	<input checked="" type="checkbox"/>
LBSPA-3218-B	BS-1518-B	<input type="checkbox"/>



LBSPA-3218-A



LBSPA-3218-B



## DISPOSABLE LAB COAT



Disposable lab coat manufactured with sms nonwoven.

**Presentation:** package of 100 pieces(packaged individually).

ITEM	PART NUMBER	COLOR	GRAMMAGE	MEASURE	CUFF	BIES	BAG	ZIPPER
LBLAB717	BL-4526-B-XL	<input type="checkbox"/>	22G	136 CM A X 100 CM L	ELASTIC	-	-	PLUSH AND HOOK
LBLABA	BL-4015-10-AL	<input checked="" type="checkbox"/>	30G	136 CM A X 100 CM L	COTTON	✓	✓	PLUSH AND HOOK
LBLABBSB	LBLABBSB	<input type="checkbox"/>	30G	136 CM A X 100 CM L	COTTON	✓	-	PLUSH AND HOOK
LBLABSXXL	LBLABSXXL	<input type="checkbox"/>	30G	162 CM A X 100 CM L	COTTON	✓	✓	PLUSH AND HOOK
LBLBIN	BL-4016-11-B	<input type="checkbox"/>	30G	115 CM A X 72 CM L	COTTON	✓	-	PLUSH AND CHILDREN'S HOOK
LBLAB519-L	BL-4526-20-BL	<input type="checkbox"/>	25G	136 cm A x 100 cm L	ELASTIC	-	-	PLASTIC ZIPPER
LBLAB515	BL-4016-20-BL	<input type="checkbox"/>	30G	136 CM A X 100 CM L	COTTON	✓	-	PLASTIC ZIPPER
LBLABB-S	BL-4010-B-S	<input type="checkbox"/>	30G	110 CM A X 95 CM L	COTTON	✓	✓	PLUSH AND HOOK
LBLABB-M	BL-4010-B-M	<input type="checkbox"/>	30G	120 CM A X 100 CM L	COTTON	✓	✓	PLUSH AND HOOK
LBLABB- L	BL-4010-B-L	<input type="checkbox"/>	30G	136 CM A X 100 CM L	COTTON	✓	✓	PLUSH AND HOOK
LBLABB-XL	BL-4010-B-XL	<input type="checkbox"/>	30G	150 CM A X 100 CM L	COTTON	✓	✓	PLUSH AND HOOK
LBLABB-XXL	BL-4010-B-XXL	<input type="checkbox"/>	30G	162 CM A X 100 CM L	COTTON	✓	✓	PLUSH AND HOOK
LBLABB19-L	BL-4515-B-L	<input type="checkbox"/>	30G	136 CM A X 100 CM L	ELASTIC	✓	✓	PLUSH AND HOOK

GOWNS / UNIFORMS

LICOMS



### Details



Cotton cuff



Elastic on cuff



With plush and hook



Bies



With zipper



Chest bag



## DISPOSABLE LAB COAT WITH SNAP CLOSURE



Disposable lab coat manufactured with nonwoven, long sleeves with elastics on the cuffs, two frontal pockets and 4 plastic snaps.

**Presentation:** case with 100 pieces (packaged individually).

ITEM	PART NUMBER	COLOR	GRAMMAGE	MEASURE	SIZE
LBAS-L	LBL-5330-L	<input type="checkbox"/>	30G	130 CM A X 100 CM L	L
LBAS-XL	LBL-5330-XL	<input type="checkbox"/>	30G	140 CM A X 100 CM L	XL
LBAS-50-L	LBAS-1750-L	<input type="checkbox"/>	50G	130 CM A X 100 CM L	L
LBAS-50-XL	LBAS-1750-L	<input type="checkbox"/>	50G	140 CM A X 100 CM L	XL

### Details



Snap Closure



Elastic on cuff



## DISPOSABLE LAMINATED GOWN



Disposable gown made in laminated textil of 50g, long sleeve with elastic on the cuffs, two front pockets and 4 plastic snaps.

**Presentation:** case with 50 pieces (packaged individually).

ITEM	PART NUMBER	COLOR	ZIPPER	MEASURE
LBLB122-M	BL-6250-M	<input type="checkbox"/>	SNAP CLOSURE	120 CM A X 95 CM L
LBLB122-L	BL-6250-L	<input type="checkbox"/>	SNAP CLOSURE	130 CM A X 100 CM L
LBLB122-XL	BL-6250-XL	<input type="checkbox"/>	SNAP CLOSURE	140 CM A X 105 CM L
LBLB122-VEL	BL-6240-L	<input type="checkbox"/>	VELCRO	130 CM A X 100 CM L

### Details



Elastic on cuff



Snap Closure



Velcro





## DISPOSABLE SURGEON GOWN



Disposable gown made of SMS fabric, medical grade and hypo-allergenic, with outline, long sleeve, with cotton cuff, and 4 straps (2 in the upper part and 2 in the middle part)

**Measures:** 150cm width x 125cm high

**Presentation:** package of 10 pieces.

ITEM	PART NUMBER	COLOR	ZIPPER
LBCBB	BG-1835-B	<input type="checkbox"/>	WITHOUT REINFORCEMENT
LBCBA	BG-1835-A	<input checked="" type="checkbox"/>	WITHOUT REINFORCEMENT
LBC-1825	BG-1825-A	<input checked="" type="checkbox"/>	REINFORCEMENT IN CHEST AND ARM



Details



Bias



Cotton cuff

## DISPOSABLE PATIENT GOWN



Disposable gown made of SMS fabric with tie straps on the waist.

**Presentation:** package of 10 pieces.

ITEM	PART NUMBER	COLOR	GRAMMAGE	MEASURE
LBPAEA20	BP-1140-A	<input checked="" type="checkbox"/>	30G	140 CM A X 119 CM L
LBPAEB20	BP-1140-B	<input type="checkbox"/>	30G	140 CM A X 119 CM L
LBPA-1124	BP-1124-A	<input checked="" type="checkbox"/>	25G	135 CM A X 100 CM L
LBPA-1134	BP-1134-A	<input checked="" type="checkbox"/>	30G	135 CM A X 100 CM L

\*Also available in children's sizes.



Gown with outline  
LBPAEA20

Gown without outline  
LBPA-1124/1134



Gown without outline  
LBPA-1124/1134

Gown with outline  
LBPAEA20



## UNIFORMS AND SMURFS



Disposable uniforms made of SMS fabric, hypoallergenic, with outline and overcasting.

**Presentation:** packaged individually.

### SIMPLE UNIFORM

ITEM	PART NUMBER	COLOR	GRAMMAGE	OUTLINE	BAG
LPUSA	U-1930-A	Blue	30G	✓	✓
LPUSB	U-1930-B	White	30G	✓	✓

**Contains:**

- Surgical scrub suit with outline and pockets
- Trousers



ITEM	PART NUMBER	COLOR	GRAMMAGE	OUTLINE	BAG
LPUSA-1825	U-1925-A	Blue	25G	-	-
LPUSB-1825	U-1925-B	White	25G	-	-

**Contains:**

- Surgical scrub suit
- Trousers



### COMPLETE UNIFORM

ITEM	PART NUMBER	COLOR	GRAMMAGE	OUTLINE	BAG
LPUCA	U-1840-10-A	Blue	30G	✓	✓
LPUCB	U-1840-10-B	White	30G	✓	✓

**Contains:**

- Surgeon Hat
- Facemask
- Surgical scrub suit with outline and pockets
- Trousers
- Shoe covers



GOWNS / UNIFORMS

LICOMS

## SURGICAL SCRUB SUIT



Disposable surgical scrub suit, made of SMS fabric with outlines, short sleeve, V neck and frontal pocket.

**Measures:** 80cm of width x 78cm of height.

**Presentation:** package of 10 pieces.

ITEM	PART NUMBER	COLOR
LFCA	UPF-1825-A	Blue
LFCB	UPF-1825-B	White



## DISPOSABLE PANTS



Disposable type surgeon trousers made of SMS fabric, medical grade and hypoallergenic, with elastic at the waist and embroidery.

**Measures:** standard of 120cm of circumference of waist x 111 cm of height

**Presentation:** package of 10 pieces.

ITEM	PART NUMBER	COLOR
LPCA	UPP-1826-A	Blue
LPCB	UPP-1826-B	White





## DISPOSABLE THONG



Disposable thong manufactured with nonwoven of 30g, with elastic at the waist.

**Presentation:** package of 10 pieces

ITEM	PART NUMBER	COLOR
LTDA	ST-1940-A	
LTDB	ST-1940-B	



## DISPOSABLE PANTIES



Disposable panties manufactured with nonwoven of 30g, embroiled, and with elastic in the waist and leg.

**Presentation:** package of 10 pieces.

ITEM	PART NUMBER	COLOR
LTRUA	SPT-1950-A	
LTRUB	SPT-1950-B	



## DISPOSABLE BRA



Disposable bra manufactured with nonwoven of 30g with elastic to adjust and tie straps on the back.

**Presentation:** package of 10 pieces.

ITEM	PART NUMBER	COLOR
LTDNAD	ST-1960-A	
LTDNBD	ST-1960-B	





## DISPOSABLE BOXER BRIEF



Disposable boxer manufactured with nonwoven of 30g, with elastic at waste.

**Presentation:** package of 10 pieces.



ITEM	PART NUMBER	COLOR
------	-------------	-------

LBCAE	SB-1970-A	
-------	-----------	--

## BEDS COVERS, BED SHEETS AND PILLOW COVERS



Disposable Bed covers, bed sheets and pillow covers manufactured with nonwoven.

They can be made in any grammage and measure that you wish.

**Presentation:** as required.

Type of sealed

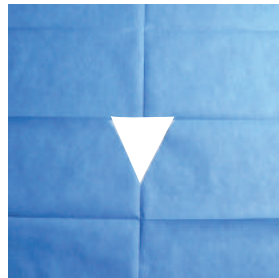
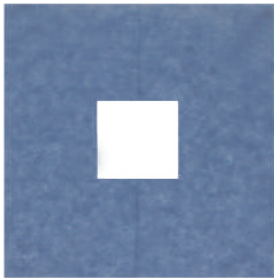

Field / Cleft field

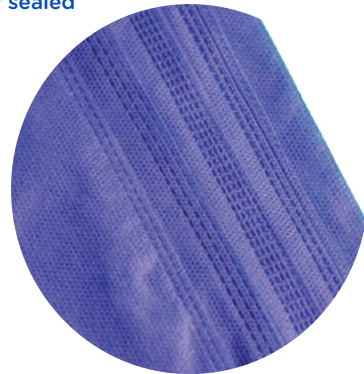

Pillow



Pillow Cover

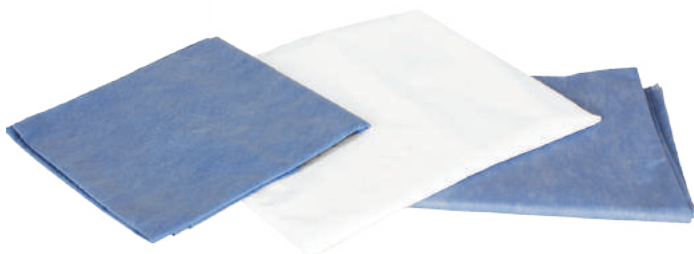

Single sheets



## MICROPOROUS LAMINATED COVERALL



Disposable coverall made in white laminated fabric, with elastics on cuffs, ankles, waste and hood; frontal plastic zipper and flap

**Presentation:** case with 25 pieces (packaged individually).

### COVERALL LIGHT / WITHOUT BOOT / PRACTI CLEAN

ITEM	SIZE
LOTY132-M	MEDIUM
LOTY132-L	LARGE
LOTY132-XL	EXTRA LARGE
LOTY132-XXL	DOUBLE EX- LARGE
LOTY132-XXXL	TRIPLE EX- LARGE

*Practi Clean*

### COVERALL MEDIUM / WITHOUT BOOT

ITEM	SIZE
LOTY122-S	SMALL
LOTY122-M	MEDIUM
LOTY122-L	LARGE
LOTY122-XL	EXTRA LARGE
LOTY122-XXL	DOUBLE EX- LARGE

### COVERALL HEAVY / WITHOUT BOOT

ITEM	SIZE
LOTY1260-S	SMALL
LOTY1260-M	MEDIUM
LOTY1260-L	LARGE
LOTY1260-XL	EX- LARGE
LOTY1260-XXL	DOUBLE EX- LARGE

### COVERALL WITH BOOT

ITEM	SIZE
LOTYB-145-XL	EX- LARGE

### COVERALL MEDIUM / WITHOUT BOOT

ITEM	SIZE
LOTY150-S	SMALL
LOTY150-M	MEDIUM
LOTY150-L	LARGE
LOTY150-XL	EXTRA LARGE
LOTY150-XXL	DOUBLE EX- LARGE

Details



Flap closure(zipper)



Elastic on cuff



Seam reinforcement





## MICROPOROUS COVERALL



Disposable coverall manufactured with nonwoven of 50g, with elastic on the cuffs, ankles, waste and hood; and frontal plastic zipper.

**Presentation:** case with 50 pieces (packaged individually).

ITEM	SIZE
LOV1025-S	SMALL
LOV1025-M	MEDIUM
LOV1025-L	LARGE
LOV1025-XL	EX- LARGE
LOV1025-XXL	DOUBLE EX- LARGE

Details



Elastic on back



Flap closure(Zipper)



## MICROPOROUS LAMINATED BREATHABLE COVERALL



Disposable coverall with cooling technology on the back, manufactured with sms nonwoven, with elastic on cuffs, ankles and hood; and frontal zipper with flap, with elastic on the back.

**Presentation:** case with 25 pieces (packaged individually).

ITEM	SIZE	HAT
LOTYMS 155-M	MEDIUM	✓
LOTYMS 155-L	LARGE	✓
LOTYMS 155-XL	EX- LARGE	✓
LOTYMS 155-XXL	DOUBLE EX- LARGE	✓
LOTYMS 178-M	MEDIUM	-
LOTYMS 178-L	LARGE	-
LOTYMS 178-XL	EX- LARGE	-
LOTYMS 178-XXL	DOUBLE EX- LARGE	-





**DUST SHOE COVER**



Disposable shoe cover manufactured with sms n onwoven of 30g, and elastic use to adjust the ankle.

**Presentation:** case with 1000 pieces (10 packages with 100pieces)

ITEM	PART NUMBER	COLOR	SEALING	INSOLE
LCZA25-S	LCZ-7025-A	<input checked="" type="checkbox"/>	<input checked="" type="checkbox"/>	SIMPLE
LCZB25-S	LCZ-7025-B	<input type="checkbox"/>	<input checked="" type="checkbox"/>	SIMPLE
LCZA25-20-S	LCZ-7025-20-A	<input checked="" type="checkbox"/>	<input checked="" type="checkbox"/>	WITH ELASTIC
LCZB25-20-S	LCZ-7025-20-B	<input type="checkbox"/>	<input checked="" type="checkbox"/>	WITH ELASTIC



LCZA25-S



LCZB25-20-S



LCZA25-20-S



LCZB25-S

**NON-SLIP SHOE COVER**



Shoe covering manufactured with nonwoven, elastic use to adjust the ankle and non slip treatment.

**Presentation:** box with 1,000 pieces (10packages with 100 pieces).

ITEM	PART NUMBER	COLOR	SIZE	INSOLE	TYPE OF UNION
LCZB16	CZ-7075-16-B	<input type="checkbox"/>	16"	WITH ELASTIC	SEWN
LCZA18	CZ-7075-16-A	<input checked="" type="checkbox"/>	18"	WITH ELASTIC	SEWN
LCZA16-S	LCZ-7076-16-A	<input checked="" type="checkbox"/>	16"	SIMPLE	SEALED
LCZB16-S	LCZ-7076-16-B	<input type="checkbox"/>	16"	SIMPLE	SEALED
LCZA16-20-S	LCZ-7077-16-A	<input checked="" type="checkbox"/>	16"	WITH ELASTIC	SEALED
LCZB16-20-S	LCZ-7077-16-B	<input type="checkbox"/>	16"	WITH ELASTIC	SEALED



LCZA16-20-S



LCZB16-S



LCZA16-S



LCZB16-20-S



**POLYETHYLENE SHOE COVER**



Disposable shoe cover made in polyethylene of 6 mil of thickness and a elastic use to adjust the ankle.

**Presentation:** case with 300 pieces (3 packages of 100 pieces).

ITEM	PART NUMBER	COLOR
LCZPDA	LCZ-7018-B	
LCZPDB	LCZ-7018-A	



**BICOLOR SHOE COVER**



Disposable shoe cover manufactured with nonwoven white 30g, coated of blue polyethylene and a elastic use to adjust the ankle.

**Presentation:** package of 100 pieces (50 pairs).

ITEM	COLOR
LCZ-4035-16	



**DISPOSABLE PVC TEMPLATE BOOT**



Disposable polypropylene shoe cover with PVC insole with textile and elastic reinforcement in the superior part.

**Presentation:** case with 25 pairs.

ITEM	PART NUMBER	INSOLE
LCZA-645-BB	BPP-6450-B	
LCZA-645-BA	BPP-6451-A	
LCZA-645-BR	BPP-6452-R	





## LAMINATED SHOE COVER



Disposable shoe cover made of laminated fabric and elastics to adjust the ankle.

**Presentation:** case with 1,000 pieces (10 packages with 100 packages).

ITEM	PART NUMBER	COLOR	GRAMMAGE
LCZ50-122	LCZ-1221	<input type="checkbox"/>	50g



## SIMPLE DISPOSABLE LAMINATED BOOT



Disposable boot made in laminated fabric of 30g, with elastics to adjust.

**Presentation:** package of 50 pieces (25 pairs).

ITEM	PART NUMBER	COLOR
LBS-122	BL-1220-B	<input type="checkbox"/>



## POLYETHYLENE BOOT COVER



Disposable boot covers made of transparent polyethylene.

**Presentation:** case with 500 pieces.

ITEM	PART NUMBER	DETAIL
LBDP5E	BP-5075	ELASTIC
LBDP55T	BP-5070	STRIPS



Boot with strips



Boot with elastic

48 cm

## DISPOSABLE LAMINATED BOOT WITH INSOLE



Disposable boot made in laminated fabric of 55g.

**Presentation:** package of 50 pieces (25 pairs).

ITEM	COLOR	MEASURE
LCZ-12238-16	<input type="checkbox"/>	16"
LCZ-12238-18	<input type="checkbox"/>	18"



## DISPOSABLE SURGICAL BOOTS



Disposable boot manufactured with sms nonwoven.

**Presentation:** package of 50 pieces (25 pairs).

ITEM	PART NUMBER	COLOR	GRAMMAGE	UNION	DETAILS
LBPS25AS	BC-7625-A	Blue	25G	SEALED	WITH STRIPS
LBPS30AS	BC-7630-A	Blue	30G	SEALED	WITH STRIPS
LBPS35AS	LBPS35AS	Blue	35G	SEALED	WITH STRIPS
LBPS25A	BC-7510-A	Blue	25G	SEWN	WITH STRIPS
LBPS35A	BC-7511-A	Blue	35G	SEWN	WITH STRIPS
LBPS30BS	LBPS30BS	White	30G	SEALED	WITH STRIPS
LBPS30V	BC-7515-V	Green	30G	SEWN	WITH STRIPS
LBS25A-E	LBS25A-E	Blue	25G	SEWN	SUPERIOR ELASTIC
LBS25B-E	LBS25B-E	White	25G	SEWN	SUPERIOR ELASTIC
LBS50A-XL-E	LBS50A-XL-E	Blue	50G	SEWN	SUPERIOR ELASTIC
LBCPA30	LBCPA30	Blue	30G	SEWN	WITH STRIPS / WITH INSOLE
LBCPB30	LBCPB30	White	30G	SEWN	WITH STRIPS / WITH INSOLE



SHOE COVER

LICOMS

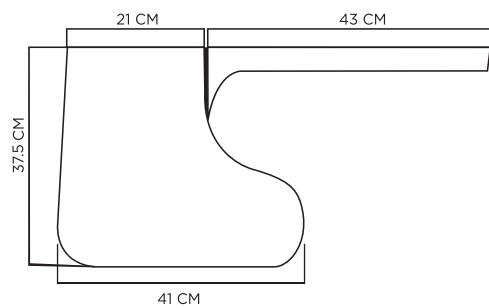

Details

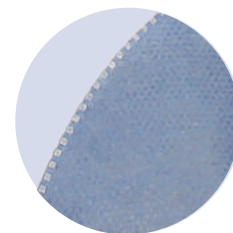

Sealed



**POLYETHYLENE OVERSLEEVE**



Disposable polyethylene oversleeve of 18" of long, with elastic at both ends.

**Presentation:** case with 5,000 pieces (50 packages of 100 pieces).

ITEM	PART NUMBER	COLOR
LMPDA	MPT-2808	
LMPDB	MPT-2809	



**DISPOSABLE VINIL OVERSLEEVE**



Disposable oversleeve made in vinyl (PVC), of 6 mil of thickness and 18" of long, with elastic at both ends.

**Presentation:** case with 72 pairs.

ITEM	PART NUMBER	COLOR
LMVDA	MV-3020	



**LAMINATED OVERSLEEVE**



Disposable oversleeve made in laminated fabric of 18" of long, with elastic at both ends.

**Presentation:** case with 1,000 pieces (50 packages of 100 pieces).

ITEM	PART NUMBER	COLOR
LMBTY18	ML-3019	



**DENIM OVERSLEEVE**



Oversleeve in 18" long denim, with elastic at both ends.

**Presentation:** per piece

ITEM	PART NUMBER	COLOR
LMMA-3018	MM-3018	



**OVERSLEEVE KEVLAR**



Kevlar oversleeve of 18" of long, with thumb adjustment.

**Presentation:** per piece

ITEM	PART NUMBER	COLOR
LMT-6540	MK-6540	



**COOL COTTON OVERSLEEVE**



Oversleeve made in cotton of 18" of long, with thumb adjustment.

**Presentation:** per piece.

ITEM	PART NUMBER	DETAILS
LMT-6085	MA-6085	WITH THUMB HOLE
LMT-6087	MA-6087	WITHOUT THUMB HOLE





## POLYETHYLENE APRON



Disposable apron made of polyethylene.

Measures: 28"x46" (71cm of width x177 cm of height).

**Presentation:** case with 1,000 pieces (10 packages of 100 pieces packaged individually).

ITEM	PART NUMBER	COLOR
LMDPA	MPT-2808	<input type="checkbox"/>
LMDPB	MPT-2809	<input type="checkbox"/>

**Presentation:** case with 1,000 pieces (10 packages of 100 pieces).

ITEM	PART NUMBER	COLOR
LMDP28	MPT-2810	<input type="checkbox"/>



Individual dispenser



Blue

Detail



Laces at back

## NON-WOVEN APRON



Disposable apron made with cooling technology of non woven fabric.

**Measures:** 60cm of width x90cm of height.

**Presentation:** package of 100 pieces.

ITEM	PART NUMBER	COLOR	TYPE
LMD-122-70X90	ML-122-70X90	<input type="checkbox"/>	LAMINATED
LMPB60X90	MTNT-150-6090	<input type="checkbox"/>	POLYPROPYLENE
LMPB70X110	MTNT-7011	<input type="checkbox"/>	POLYPROPYLENE



Details



Sewing in strips



Laces at back



## PVC APRON



Apron of one piece made in calibre 16 PVC fabric.

**Measures:** 90cm of width x115 of height.

**Presentation:** case with 72 pieces.

ITEM	PART NUMBER	COLOR
LMDAV06	MPVC-1320	

Details



Neck



Laces at back



## CANVAS APRON



Apron made in PVC resine endured fabric with laces to tie.

**Measures:** 70cm width x110cm of height.

**Presentation:** per piece.

ITEM	PART NUMBER	COLOR
LMLR	ML-1420-R	
LMLB	ML-1420-B	
LMLAM	ML-1420-A	
LMLA	ML-1420-AZ	

Details

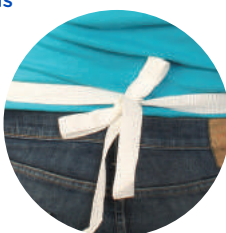



## VYNIL / PATENT LEATHER APRON



Apron made of white patented leather with laces to tie at the back, caliber 16mil.

**Presentation:** per piece.

ITEM	PART NUMBER	COLOR	MEASURE
LMV70X110	MVC-7020	<input type="checkbox"/>	70 CM A X 110 CM L
LMV90X120	MVC-9020	<input type="checkbox"/>	90 CM A X 120 CM L



Laces at back

Details



Union of apron

## APRON 15-200



15-200 White PVC apron.

**Measures:** 70cm of width x110cm of hight.

**Presentation:** case with 12 pieces.

ITEM	PART NUMBER	COLOR
LMV-15-200BL	MDV-1520	<input type="checkbox"/>



Buckle

Details



Clip on back



**ALYGER<sup>®</sup>**  
Safety and Hygiene

**DEVELOPMENT  
OF CUSTOM  
PROJECTS!**







## APRON OVER TOP / KITCHEN APRON



High resistance apron made of thermoplastic polyurethane, with buckle for a better fit on the neck, resistant to cutting, tearing and abrasion. Resistant to chemicals, oils and fats.

Soft, comfortable, light, flexible and easy to clean.

Sealed and seam-free, 100% waterproof.

One size.

**Measures:** 90x 120cm

**Presentation:** box with 24 pieces.

ITEM	PART NUMBER	COLOR
LM-CT90-120B	MOT-9120	<input type="checkbox"/>



Details



Buckle

## DENIM APRON



Apron made of denim.

Measures: 60cm of width x90cm of height

**Presentation:** per piece

ITEM	PART NUMBER	DETAILS
LMM-3050	MDM-3050	WITH BAG
LMM-3000	MDM-3000	WITHOUT BAG



Details



Frontal pocket



Cord on neck



Laces at waist



## INDUSTRIAL LUMBAR



Industrial lumbar of 8" of width with elastic band of 4" of width, and frontal grip with hook and loop.

**Presentation:** per piece.

### ELASTIC GIRDLE

ITEM	PART NUMBER	SIZE
LF-0150-S	LF-0150-S	SMALL
LF-0150-M	LF-0150-M	MEDIUM
LF-0150-L	LF-0150-L	LARGE
LF-0150-XL	LF-0150-XL	EX- LARGE

### ELASTIC GIRDLE WITH 3RD BELT

ITEM	PART NUMBER	SIZE
LF-0155-S	LF-0155-S	SMALL
LF-0155-M	LF-0155-M	MEDIUM
LF-0155-L	LF-0155-L	LARGE
LF-0155-XL	LF-0155-XL	EX- LARGE
LF-0155-XXL	LF-0155-XXL	DOUBLE EX- LARGE

Details



3rd belt



Cross straps



## WRISTBAND



Wristband made with elastic fabric of 12" of long times 4" of width, fastened of hook and loop and a reinforcement for the thumb.

**Presentation:** per piece

ITEM	CLOSURE
LMU4	ONE SIZE





## INDIRECT VENTILATION GOGGLES



Goggles made of polycarbonate of one piece, tough for impacts and surface against scratches. It has a side protection barrier, with valves that allows air to flow and a elastic band to adjust at the nape.

**Presentation:** case with 12 pieces.

ITEM	COLOR		
LL-1031			



## DIRECT VENTILATION GOGGLES



Goggles made of polycarbonate of one piece, tough for impacts and with surface against scratches. It has a side protection barrier, with perforations that allows air to flow and a elastic band to adjust at the nape.

**Presentation:** case with 12 pieces.

ITEM	COLOR		
LL-1030			



## CLEAR GLASS 2" X4"



Clear glass for welding helmet, measure 2" of height x 4" of width.

**Presentation:** package of 50 pieces.

ITEM	COLOR		
MV2X4			

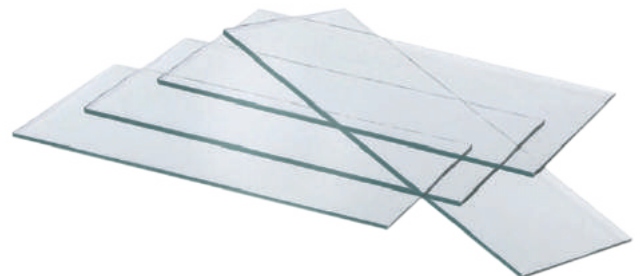



## SAFETY GLASSES / SPORT GLASSES



One piece glasses, made of polycarbonate free of metals, tough for impact and glass against scratches.

**Presentation:** case with 300 pieces (25 cases with 12pieces).

ITEM	COLOR
LL-1020	CLEAR MICA
LL-1021	BLUE MICA
LL-1022	YELLOW MICA
LL-1023	GRAY MICA
LL-1020A	CLEAR MICA C / ANTIFOG
LL-1021A	BLUE MICA C / ANTIFOG
LL-1022A	YELLOW MICA C / ANTIFOG
LL-1023A	GRAY MICA C / ANTIFOG



## CLASSIC GLASSES WITH FRAME



One piece glasses made with polycarbonate glass, tough for impact and glass against scratches. Frame Made of nylon with flexible and adjustable rods

**Presentation:** case with 300 pieces (25 cases with 12 pieces).

ITEM	COLOR
LL-1010	BLACK FRAME / CLEAR MICA
LL-1011	BLACK FRAME / GRAY MICA
LL-1012	TRICOLOR FRAME / CLEAR MICA
LL-1013	BLACK FRAME / MICA AMBER
LL-1010A	BLACK FRAME / CLEAR MICA / WITH ANTIFOG
LL-1011A	BLACK FRAME / GRAY MICA / WITH ANTIFOG
LL-1012A	BLUE FRAME / CLEAR MICA / WITH ANTIFOG
LL-1013A	BLACK FRAME / MICA AMBER / WITH ANTIFOG





## MAX 30 EARPLUG



Disposable earplug made of polyurethane foam that reduce noise 33 decibels.

**Presentation:** case with 100 pieces.

ITEM	DETAILS
TA-8033	WITH LACES
TA-8133	WITHOUT LACES



## MAX LITE EARPLUG



Disposable earplug made of polyurethane foam that reduce noise 30 decibels.

**Presentation:** case with 100 pieces.

ITEM	DETAILS
TA-8030	WITH LACES
TA-8130	WITHOUT LACES



## LASER LITE EARPLUGS



Disposable earplug made of polyurethane foam that reduce noise 28 decibels.

**Presentation:** case with 100 pieces.

ITEM	DETAILS
TA-8232	WITH LACES
TA-8132	WITHOUT LACES



## REUSABLE EARPLUGS



Reusable mushroom type earplugs with triple barrier for noise attenuation with a long of 30mm and max width 14mm and it reduces de noise 26 decibels.

**Presentation:** per piece

ITEM	PACKAGE
TA - 8525	POLYETHYLENE BAG
TA - 8526	PLASTIC CASE



## EARMUFFS



M2 red earmuffs, made of light plastic and cover in softcoat that helps reduce de noise.

**Presentation:** per piece.

ITEM
LTA-8600





## PLASTIC FOOT GUARD

Protector made of thermo foam plastic with rubber bands to adjust sole and heel.

**Presentation:** per pair.

ITEM	SIZE
LCZ-500	ONE SIZE



## ALUMINUM ALLOY SHIN GUARDS

Protector made in aluminum of aeronautical quality and it is covered in shock absorbing foam internally.

**Presentation:** per pair.

ITEM	SIZE
LCZ-323	ONE SIZE



## ALUMINUM FOOT GUARD

Protector made in aluminum of aeronautical quality with plastic holder and rubber band to adjust in heel.

**Presentation:** per pair.

ITEM	SIZE
LCZ-200	ONE SIZE



Vista inferior



## PLASTIC SHIN GUARD

Protector made in polyethylene of .140" thickness and it is covered in shock absorbing foam internally.

**Presentation:** per pair.

ITEM	SIZE
LCZ-324	ONE SIZE



## ALUMINUM METATARSAL GUARD

Protector made in aluminum of aeronautical quality with plastic holder and rubber band to adjust in heel.

**Presentation:** per pair.

ITEM	SIZE	DETAILS
LCZ-800	ONE SIZE	WITHOUT ADJUSTMENT
LCZ-801	ONE SIZE	WITH ADJUSTMENT



## BLACK INDUSTRIAL BOOT



Industrial boot with non-slip sole of 40cm high. It is recommended in areas where there's water, mud, waste, animal fats, detergents and low temperatures.

**Presentation:** per pair.

WITHOUT BUSHING		WITH BUSHING		WITH BUSHING NITRILE SOLE	
ITEM	SIZE	ITEM	SIZE	ITEM	SIZE
LBN-7003	3	LBN-7203	3	LBN-7303	3
LBN-7004	4	LBN-7204	4	LBN-7304	4
LBN-7005	5	LBN-7205	5	LBN-7305	5
LBN-7006	6	LBN-7206	6	LBN-7306	6
LBN-7007	7	LBN-7207	7	LBN-7307	7
LBN-7008	8	LBN-7208	8	LBN-7308	8
LBN-7009	9	LBN-7209	9	LBN-7309	9
LBN-7010	10	LBN-7210	10	LBN-7310	10
LBN-7011	11	LBN-7211	11	LBN-7311	11



RESISTANCE	WHITE SOLE, BLACK OR YELLOW	RED NITRILE SOLE	RED NITRILE SOLE AND BUSHING
	GARDENING OR AGRICULTURAL	INDUSTRIAL HIGH RESISTANCE	A.R WITH STEEL TEMPLATE
Water and mud	E	E	E
Detergents	B	E	E
Animal waste	B	E	E
Oils, grease, gasoline	N	E	E
Diluted acids	N	E	E
Blood	N	E	E
Low Temperature	B	E	E
Impact protection	N	N	E

E= Excellent    B= Good    N= Not Recommended

FOOT / LEG PROTECTION

LICOMS

## WHITE AGRICULTURE BOOT



YELLOW SOLE WITHOUT BUSHING		YELLOW SOLE WITH BUSHING		RED NITRILE SOLE WITH BUSHING	
ITEM	SIZE	ITEM	SIZE	ITEM	SIZE
LBB-7103	3	LBB-7203	3	LBB-7303	3
LBB-7104	4	LBB-7204	4	LBB-7304	4
LBB-7105	5	LBB-7205	5	LBB-7305	5
LBB-7106	6	LBB-7206	6	LBB-7306	6
LBB-7107	7	LBB-7207	7	LBB-7307	7
LBB-7108	8	LBB-7208	8	LBB-7308	8
LBB-7109	9	LBB-7209	9	LBB-7309	9
LBB-7110	10	LBB-7210	10	LBB-7310	10
LBB-7111	11	LBB-7211	11	LBB-7311	11





---

# GLOVES SECURITY

---





## POLYETHYLENE GLOVE



Disposable gloves made of transparent polyethylene, ambidextrous, light and resistant.

**Presentation:**

Case with 10,000 pieces  
(100 packages of 100 pieces)

Case with 10,000 pieces  
(10 cases with 1,000 pieces)

ITEM	PART NUMBER	SIZE	ITEM	PART NUMBER	SIZE
LGPM	GPT-8010-M	MEDIUM	LGPM-77	GPT-8011-M	MEDIUM
LGPG	GPT-8010-L	LARGE	LGPG-77	GPT-8011-L	LARGE



Dispenser



## VINYL GLOVE



Disposable gloves made in transparent vinyl of 4mil of thickness and 9" of height, ambidextrous, latex free and non sterile.

**Presentation:** case with 1,000 pieces (10 dispensers of 100 pieces).

LOW IN DUST

DUST FREE

ITEM	PART NUMBER	SIZE	ITEM	PART NUMBER	SIZE
LGVPS	GDV-8020-S	SMALL	LGVS	GDV-8025-S	SMALL
LGVPM	GDV-8020-M	MEDIUM	LGVM	GDV-8025-M	MEDIUM
LGVPG	GDV-8020-L	LARGE	LGVG	GDV-8025-L	LARGE
LGVPEX	GDV-8020-XL	EX-LARGE	LGVEX	GDV-8025-XL	EX-LARGE



Low in dust  
Dispenser



Free of dust  
Dispenser



## LATEX GLOVE



Disposable glove made in natural latex of 4mil of thickness and 9" of height, ambidextrous and non sterile.

**Presentation:** case with 1,000 piece (10 dispensers of 100 pieces).

LOW IN DUST

DUST FREE

ITEM	PART NUMBER	SIZE	ITEM	PART NUMBER	SIZE
LGLPS	GDL-8040-S	SMALL	LGLS	GDL-8040-S	SMALL
LGLPM	GDL-8040-M	MEDIUM	LGLM	GDL-8040-M	MEDIUM
LGLPG	GDL-8040-L	LARGE	LGLG	GDL-8040-L	LARGE
LGLPEX	GDL-8040-XL	EX-LARGE	LGLEX	GDL-8040-XL	EX-LARGE



Dispenser





## NITRILE GLOVES IN VARIETY COLORS



Disposable gloves made in nitrile of 9" of height, ambidextrous, latex free and non sterile.

**Presentation:** case with 1,000 pieces (10 dispensers of 100 pieces).



### BLACK

ITEM	PART NUMBER	SIZE
GNPR-S-BK	GDN-8071-S	SMALL
GNPR-M-BK	GDN-8071-M	MEDIUM
GNPR-L-BK	GDN-8071-L	LARGE
GNPR-XL-BK	GDN-8071-XL	EX-LARGE

### GREEN

ITEM	PART NUMBER	SIZE
GNPR-S-GR	GDN-8072-S	SMALL
GNPR-M-GR	GDN-8072-M	MEDIUM
GNPR-L-GR	GDN-8072-L	LARGE
GNPR-XL-GR	GDN-8072-XL	EX-LARGE

### WHITE

ITEM	PART NUMBER	SIZE
GNPR-S-1M-WH	GDN-8073-S	SMALL
GNPR-M-1M-WH	GDN-8073-M	MEDIUM
GNPR-L-1M-WH	GDN-8073-L	LARGE
GNPR-XL-1M-WH	GDN-8073-XL	EX-LARGE

### ORANGE

ITEM	PART NUMBER	SIZE
GNPR-S-1M-OR	GDN-8074-S	SMALL
GNPR-M-1M-OR	GDN-8074-M	MEDIUM
GNPR-L-1M-OR	GDN-8074-L	LARGE
GNPR-XL-1M-OR	GDN-8074-XL	EX-LARGE

DISPOSABLES GLOVES

LICOMS

## LATEX THIMBLES



Disposable thimbles made of natural latex and free of dust.

**Presentation:**

ITEM	PART NUMBER	SIZE
LDELAS	DLA-8240-S	SMALL
LDELAM	DLA-8240-M	MEDIUM
LDELAG	DLA-8240-L	LARGE
LDELAEX	DLA-8240-XL	EX-LARGE



## POLYETHYLENE GLOVE OF 35" HEIGHT



Disposable glove made of transparent polyethylene, ambidextrous, light and resistant.

**Presentation:** case with 1,000 pieces (10 dispensers of 100 pieces).

ITEM	PART NUMBER	SIZE
LGP35	GPT-3510	ONE SIZE





## NITRILE GLOVE



Disposable glove made of nitrile with texture in the fingers, ambidextrous, latex free and non sterile.

**Presentation:** case with 1,000 pieces (10 dispensers of 100 pieces).

3.5 mm thickness  
/ 9" long

ITEM	PART NUMBER	SIZE
LGNAS	GDN-8055-S	SMALL
LGNAM	GDN-8055-M	MEDIUM
LGNAAG	GDN-8055-L	LARGE
LGNAEX	GDN-8055-XL	EX-LARGE

3.5 mm thickness  
/ 9" long

ITEM	PART NUMBER	SIZE
LGNA-C-S	GDN-8050-S	SMALL
LGNA-C-M	GDN-8050-M	MEDIUM
LGNA-C-L	GDN-8050-L	LARGE
LGNA-C-XL	GDN-8050-XL	EX-LARGE

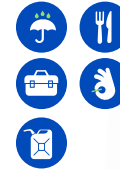

5 mm thickness  
/ 9" long

ITEM	PART NUMBER	SIZE
LGNA-5M-S	GDN-8060-S	SMALL
LGNA-5M-M	GDN-8060-M	MEDIUM
LGNA-5M-L	GDN-8060-L	LARGE
LGNA-5M-XL	GDN-8060-XL	EX-LARGE

8 mm thickness / 12" long  
Case with 500 pieces  
(10 dispensers of 50 pieces)

ITEM	PART NUMBER	SIZE
LGNA-8M-S	GDN-8070-S	SMALL
LGNA-8M-M	GDN-8070-M	MEDIUM
LGNA-8M-L	GDN-8070-L	LARGE
LGNA-8M-XL	GDN-8070-XL	EX-LARGE



DISPOSABLES GLOVES

LICOMS



Dispenser  
3.5 mm



Dispenser  
5 mm



Dispenser  
8 mm

3.5 mm thickness / 9" long

GDN-8050-S



3.5 mm thickness / 9" long

GDN-8055-S



5 mm thickness / 9" long

LGNA-5M-S



8 mm thickness / 12" long

LGNA-8M-S



## MULTIPURPOSE GLOVES



Glove made in natural latex of 15mil of thickness and 13" of height, with internal flock and surface satin of silicone, rough in palm and fingers.

**Presentation:** case with 120 pairs (packaged individually).

ITEM	SIZE	COLOR
LGL-2011-S	SMALL	Red
LGL-2011-M	MEDIUM	Red
LGL-2011-L	LARGE	Red
LGL-2011-XL	EX-LARGE	Red



ITEM	SIZE	COLOR
LGL-2012-S	SMALL	Yellow
LGL-2012-M	MEDIUM	Yellow
LGL-2012-L	LARGE	Yellow
LGL-2012-XL	EX-LARGE	Yellow

ITEM	SIZE	COLOR
LGL-2013-S	SMALL	Green
LGL-2013-M	MEDIUM	Green
LGL-2013-L	LARGE	Green
LGL-2013-XL	EX-LARGE	Green

ITEM	SIZE	COLOR
LGL-2014-S	SMALL	Pink
LGL-2014-M	MEDIUM	Pink
LGL-2014-L	LARGE	Pink
LGL-2014-XL	EX-LARGE	Pink

ITEM	SIZE	COLOR
LGL-2015-S	SMALL	Blue
LGL-2015-M	MEDIUM	Blue
LGL-2015-L	LARGE	Blue
LGL-2015-XL	EX-LARGE	Blue

ITEM	SIZE	COLOR
LGL-2016-S	SMALL	Orange
LGL-2016-M	MEDIUM	Orange
LGL-2016-L	LARGE	Orange
LGL-2016-XL	EX-LARGE	Orange





## CANNERS GLOVE



Glove made in natural latex of 15" of thickness and 12" of height.

**Presentation:** case with 120 pairs (10 packages of 12 pairs).

ITEM	COLOR	SIZE
LG-2040-7		7
LG-2040-8		8
LG-2040-9		9
LG-2040-10		10



ITEM	COLOR	SIZE
LG-2042-7		7
LG-2042-8		8
LG-2042-9		9
LG-2042-10		10



## LATEX GLOVE AGAINST ACIDS



Glove made in latex of 38mil of thickness and with a double layer of silicone in the palm and back.

**Presentation:** case with 36 pairs.

MEASURE: 450mm		MEASURE: 375mm	
ITEM	SIZE	ITEM	SIZE
LGL-2030-8	8	LGL-2035-8	8
LGL-2030-9	9	LGL-2035-9	9
LGL-2030-10	10	LGL-2035-10	10

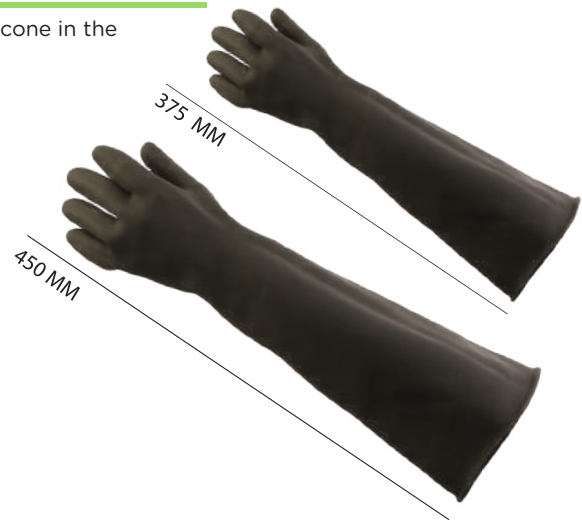

## NEOPRENE GLOVE



Glove made in neoprene of 30mil of thickness, 14" of height, plush lining, diamond-embossed palm and fingers.

**Presentation:** case with 120 pairs (10 packages of 12 pairs).

ITEM	SIZE
LGN-2050-7	7
LGN-2050-8	8
LGN-2050-9	9
LGN-2050-10	10

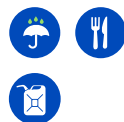



## GREEN NITRILE GLOVES



Gloves made in green nitrile of 13" of height, 15mil of thickness, with inner lining and rough surface in palms and fingers.

**Presentation:** case with 144 pairs (12 packages of 12 pairs).

ITEM	SIZE		
LGN-2080-7	7		
LGN-2080-8	8		
LGN-2080-9	9		
LGN-2080-10	10		



SYNTHETIC GLOVES

## GREEN NITRILE GLOVES OF 450MM



Glove made in green nitrile of 22mil thickness and 18" of height, with inner lining and rough surface in palms and fingers.

**Presentation:** case with 36 pairs (3 packages of 12 pairs).

ITEM	SIZE		
LGR-202045-8	8		
LGR-202045-9	9		
LGR-202045-10	10		



LICOMS



## JAPANESE COTTON GLOVES WITH PVC DOTS



Gloves made of cotton/polyester, with knitted cuff and PVC points on the palm and back.

**Presentation:** case with 300 pairs.

ITEM	SIZE	
LTG-6010-ch	SMALL	
LTG-6010	LARGE	

Applications:

- Assemble
- Authorized manufacture
- Bottling
- Gardening
- General maintenance
- Package



## JAPANESE COTTON GLOVE WITH LEATHER PALM



Glove made of cotton/polyester with leather palm and reinforcement between thumb and index finger.

**Presentation:** package of 100 pairs.

ITEM	SIZE	COLOR	
LTG-2002NT	ONE SIZE		
LTG-2003NT	ONE SIZE		





## KEVLAR GLOVE



Glove made of 100% kevlar that offers cut resistance and to abrasion.

**Presentation:** package of 12 pairs.

ITEM	CPPT CUTTING LEVEL	WEIGHT
LGT-6510	CUTTING LEVEL 2	LIGHT
LGT-6520	CUTTING LEVEL 2	MEDIUM
LGT-6530	CUTTING LEVEL 3	HEAVY



## NYLON GLOVE



Glove made of 100% stretchable nylon, lint free and it doesn't live trace.

**Presentation:** package of 12 pairs.

ITEM	SIZE
LGT-6120-S	SMALL
LGT-6120-M	MEDIUM
LGT-6120-L	LARGE



## TOWEL TYPE GLOVE



Glove type towel.

**Presentation:** package of 240 pairs.

ITEM	COLOR	CUFF
LGT-6310		COTTON
LGT-6311		COTTON
LGT-6315		SAFETY CUFF





**PU COATED GLOVE**



Glove of one piece (free of sewing), polyurethane coated palm, woven elastic cuffs and lint free.

**Presentation:** case with 120 pairs (10 packages of 12 pairs).

**GREY PU COATED GLOVE**

ITEM	SIZE	BORDER		
LGR-3210DZ-XS	EX SMALL			
LGR-3210DZ-S	SMALL			
LGR-3210DZ-M	MEDIUM			
LGR-3210DZ-L	LARGE			
LGR-3210DZ-XL	EX-LARGE			



**BLACK PU COATED GLOVE (SHADOW)**

ITEM	SIZE	BORDER		
LGR-3211DZ-XS	EX SMALL			
LGR-3211DZ-S	SMALL			
LGR-3211DZ-M	MEDIUM			
LGR-3211DZ-L	LARGE			
LGR-3211DZ-XL	EX-LARGE			



**WHITE PU COATED GLOVE**

ITEM	SIZE	BORDER		
LGR-3212-XS	EX SMALL			
LGR-3212-S	SMALL			
LGR-3212-M	MEDIUM			
LGR-3212-L	LARGE			
LGR-3212-XL	EX-LARGE			

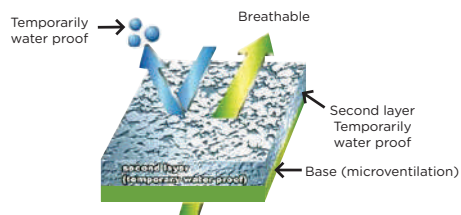





PU COATING STRUCTURE



## AGAINST STATIC ESD GLOVE

Glove made with a mixture of polyamides and carbon fiber; palm covered of polyamides, with woven elastic cuffs.

**Presentation:** case with 120 pairs (10 packages of 12 pairs).

ITEM	SIZE	BORDER
LGA-803K-S	SMALL	
LGA-803K-M	MEDIUM	
LGA-803K-L	LARGE	
LGA-803K-XL	EX-LARGE	



Applications:





- Assembly and repair of electronic equipment.
- Handling of delicate parts.
- Accuracy instruments.

## NYLON GLOVE REC. OF NITRILE

Glove made of nylon, covered in black nitrile in the palm and with woven elastic cuffs.





**Presentation:** case with 120 pairs (10 packs of 12 pairs and packed per pair).

### GREY GLOVE

ITEM	SIZE	BORDER
LGR-3115-S	SMALL	
LGR-3115-M	MEDIUM	
LGR-3115-L	LARGE	
LGR-3115-XL	EX-LARGE	



### BLACK GLOVE

ITEM	SIZE	BORDER
LGR-3116-S	SMALL	
LGR-3116-M	MEDIUM	
LGR-3116-L	LARGE	
LGR-3116-XL	EX-LARGE	

Applications:

- Package
- Transport and weight
- Agriculture
- Assembly

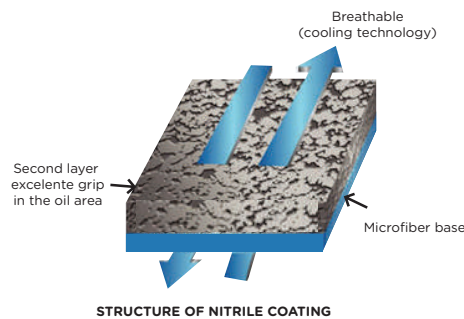



## TRIPLE LAYER REC. GLOVE



Gloves made in polyester of one piece (free of sewing), caliber 10 with rough latex cover in the palm and with a double reinforcement on the fingers.

**Presentation:** case with 120 pairs (packed per pair)

ITEM	SIZE
LGR-3230-L	LARGE



CHARACTERISTICS:

1. Reinforcement cover on the fingers.
2. Reinforcement of natural imported latex.
3. Transparent reinforcement of polycotton.



## MONSTER TYPE GLOVES



Gloves of 28cm of hight made in impregnated latex cotton by immersion (rough finish), and safety cuffs of outline reinforced canvas.

**Presentation:** case with 120 pairs.

ITEM	SIZE
LGR-3070	ESTANDAR



CHARACTERISTICS:

- Machinery and tools management
- Construction
- Gardening
- General jobs
- Management of glass and aluminum



## REC. NITRILE COATED GLOVE



Glove made of cotton with jersey lining and impregnated water resistant nitrile to grease, acids and dust.

**Presentation:** package of 120 pairs.

ITEM	SIZE	DETAILS
LGR-3040	ONE SIZE	DOUBLE LAYER COTTON CUFF
LGR-3050	ONE SIZE	DOUBLE LAYER SECURITY CUFF



CHARACTERISTICS:

- Automotive industrial.
- Furniture manufacture
- Maintenance
- Metallurgical industrial.
- Shipments
- Agriculture



LGR-3050



LGR-3040



## HPPE COVERED PU CUT RESISTANT GLOVES



Glove made based in a mixture of HPPE fibers, nylon and lycra and covered in polyurethane.

**Presentation:** case with 120 pairs (10 packages of 12 pairs).

NIVEL 5				
ITEM	SIZE	COLOR		
LGR-715B-S	SMALL			
LGR-715B-M	MEDIUM			
LGR-715B-L	LARGE			
LGR-715B-XL	EX-LARGE			

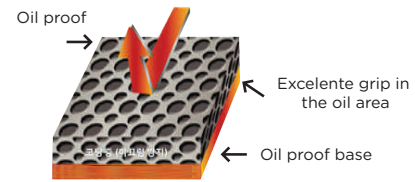

NITRILE COVER ESTRUCTURE

## HPPE CUT RESISTANTS GLOVE WITH COVER OF LEVEL 5 NITRILE



Glove made based in a mixture of HPPE fibers and it is covered of nitrile foam.

**Presentation:** case with 120 pairs (10 packages of 12 pairs, packaged per pair).

ITEM	SIZE	COLOR	BORDER				
LGC-7163-XS	EX-SMALL		PALMA				
LGC-7163-S	SMALL		PALMA				
LGC-7163-M	MEDIUM		PALMA				
LGC-7163-L	LARGE		PALMA				
LGC-7163-XL	EX-LARGE		PALMA				
LGC-7064-XS	EX-SMALL		PALMA AND BACK				
LGC-7064-S	SMALL		PALMA AND BACK				
LGC-7064-M	MEDIANO		PALMA AND BACK				
LGC-7064-L	LARGE		PALMA AND BACK				
LGC-7064-XL	EX-LARGE		PALMA AND BACK				



LGC-7163

LGC-7064



Palma



## STEEL STRING GLOVE



Glove made in high resistance fabric of stainless steel that provides protection against possible cuts.

**Presentation:** per piece

ITEM	SIZE
LGC-6810-M	MEDIUM
LGC-6810-L	LARGE
LGC-6810-XL	EX-LARGE
LGC-6810-XXL	DOUBLE EX-LARGE



## STEEL MESH GLOVES



Gloves made of stainless steel, reversible, ambidextrous, adjustment strap and latex support.

**Presentation:** per piece

ITEM	PESO	MEASURE	SIZE
LA-6870-S	210 g	213 mm	SMALL
LA-6870-M	230 g	225 mm	MEDIUM
LA-6870-L	250 g	237 mm	LARGE



DETAILS:



Latex support





## SPLIT LEATHER GLOVES



Gloves of leather, sewed with polyester string.

**Presentation:** package with 12 pairs.

ITEM	DETAILS
LC-2110	SPLIT SHORT
LC-2111	SPLIT LONG
LGR-2116	EXPO / BIES Y REFUERZO EN PALMA



Split short  
LC-2110

Split long  
LC-2111

## OPERATING LEATHER GLOVE



Glove made of tanned leather to the chrome double greased and leather cuff with outlines.

**Presentation:** package with 12 pairs.

ITEM	SIZE
LP-4010	ONE SIZE



## ARGON GLOVE



Glove made of leather, bauble greased, with fit on wrist.

**Presentation:** package with 12 pairs.

ITEM	SIZE
LP-4020	WITH BUCKLE
LP-4030	WITH ELASTIC



## WELDER GLOVE



Glove made of leather and plush inner lining with cotton canvas for a greater comfort.

**Presentation:** package with 25 pairs.

ITEM	SIZE
LGS-2121	COTTON THREAD
LGS-2122	KEVLAR THREAD
LGS-2123	KEVLAR THREAD AND REINFORCEMENT



Reinforcement

DETAILS:





## RED BRICK GLOVE



Glove made with two layers of heavy terry cloth and coated with nitrile blocks in palm and back

**Presentation:** package with 12 pairs.

ITEM	SIZE
L9460K-S	SMALL
L9460K-L	LARGE



## CHEMICAL RESISTANT GLOVES



Ergonomic chloroprene gloves with forearm extensions for the handling of high temperatures and fats, Resistance up to 260 ° C.

**Presentation:** per piece.

ITEM	SIZE
LGT-9080	ONE SIZE



## PVC COVERED GLOVES



Glove made of jersey, plush and with cotton cover of 12" of high and covered in PVC. Recommended for low temperatures and cold rooms.

**Presentation:** package of 12 pairs.

ITEM	PART OF NUMBER	LONG
GPOF-10-2R-3	GRP-6811	10"
GPOF-12-2R-3	GRP-6812	12"





**ALYGER<sup>®</sup>**

---

**ROAD  
SAFETY**





## SOLID ORANGE BASE CONE

Cone made in flexible orange PVC, with protection against UV rays.

**Presentation:** per piece.

ITEM	MEASURE
LT-9031	45CM
LT-9032	71CM
LT-9033	90CM



DETAILS:



Outside view



Interior view



## BLACK BASE CONE

Cone with black base made of flexible orange PVC, with protection against UV rays.

**Presentation:** per piece.

ITEM	LONG
LT-9035	71 cm



ADVANTAGE:

- High resistance to deformation and rupture
- Fast recovery of its original form
- Base with 8 support points

DETAILS:



Joined in one piece



Outside view



Interior view





## REFLECTIVE MESH VEST



Vest made of mesh, with polypropylene outline of 2", lateral elastic, with hook and loop clasp, and reflection of high visibility.

**Presentación:** case with 50 pieces.

### REFLECTIVE PLASTIC

ITEM	COLOR
LT-9110	Orange
LT-9111	Green
LT-9112	Blue
LT-9113	Yellow
LT-9114	White
LT-9115	Black
LT-9116	Red
LT-9117	Pink
LT-9118	Dark Blue

### REFLECTIVE FABRIC

ITEM	COLOR
LT-9210	Orange
LT-9211	Green
LT-9212	Blue
LT-9213	Yellow
LT-9214	White
LT-9215	Black
LT-9216	Red
LT-9217	Pink
LT-9218	Dark Blue



With clasp

DETAILS:



Reflective fabric



Reflective plastic

## FIREFIGHTER VEST



Vest made of 80% cotton/20% polyester fabric, it has 5 frontal bags and one in the back low part, 4 adjustable clips in the sides, frontal zipper and reflection of high visibility.

**Presentation:** per piece.

ITEM	COLOR
LT-9310	Orange
LT-9311	Green
LT-9312	Blue
LT-9313	Yellow
LT-9314	Red
LT-9315	Light Green
LT-9316	Dark Blue
LT-9317	Grey



DETAILS:



Back view





## FLAGGING TAPE



Scotch tape of 33m of long and 2" of thickness.

**Presentation:** case with 24 scotch tapes.

ITEM	COLOR	
LT-9040		
LT-9041		
LT-9042		
LT-9043		
LT-9044		
LT-9045		
LT-9046		
LT-9047		
LT-9048		

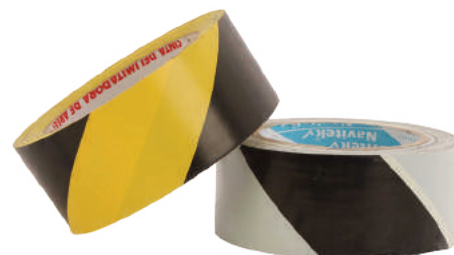

## NON-SLIP TAPE



Non-slip scotch tape.

**Presentation:** scotch tape of 18m

ITEM	COLOR	MEASURE
LT-9091		1" X 18 mts
LT-9090		2" X 18 mts



## PRECAUTIONS TAPE



Tape of 305m of long and 3" of thickness, made of virgin polyethylene, enriched with pigments and additives that make it flexible and resistant.

**Presentation:** package of 5 tapes.

ITEM	MEASURE	COLOR		
LT-9021	NO TRESPASSING			
LT-9022	CAUTION			
LT-9023	DANGER			





## SECURITY HELMET



Cap type helmet made of thermoplastic resins.

**Presentation:** per piece.

SIN MATRACA		CON MATRACA	
ITEM	COLOR	ITEM	COLOR
LT-9011		LT-9011-M	
LT-9012		LT-9012-M	
LT-9013		LT-9013-M	
LT-9014		LT-9014-M	
LT-9015		LT-9015-M	
LT-9016		LT-9016-M	
LT-9017		LT-9017-M	



## NAPE PROTECTOR



Nape protector made in cooling technology fabric of high visibility with reflective plastic of 2" of thickness, and elastic to adjust in helmet.

**Presentation:** per piece.

CLAVE	COLOR
LT-9180	
LT-9183	



DETAILS:



Back part

Back part

# COMPETITIVE ADVANTAGES





# ALYGER<sup>®</sup>

Safety and Hygiene

**WE ARE MANUFACTURERS!**  
WE ASSEMBLE YOUR PRODUCT



## OUR ADVANTAGES

- ✓ CUSTOM PRODUCTS
- ✓ CUSTOM PACKAGING
- ✓ COLOR VARIETY
- ✓ GRAMMAGE VARIETY
- ✓ MEASURE VARIETY
- ✓ MATERIAL VARIETY
- ✓ MANUFACTURING ON DESIGN

**WE DEVELOP SPECIAL PROJECTS FOR THE INDUSTRY**



**AND MUCH MORE!**

[www.alyger.com](http://www.alyger.com)

**AUTHORITIES DISTRIBUTOR**



**ALYGER<sup>®</sup>**  
Safety and Hygiene

**[www.alyger.com](http://www.alyger.com)**