



800-645-5555 • www.klingspor.com

Klingspor Abrasives Table of Contents

DISCS	SURFACE CONDITIONING	SPARTAN SANDERS 152
FOR STOCK REMOVAL3	CONVOLUTE WHEELS62	DYNABRADE TOOLS
BLACK HOOK MATERIAL4	UNITIZED WHEELS.....63	ORBITAL SANDER 153
SANDING.....7	CROSS BUFFS65	DYNASTRAIGHT..... 154
KLINGNET.....9	FOAM SANDING	DYNAFILE 156
TO COMBAT LOADING11	SPONGE BOX SQUARE PADS.66	SAFETY
BACKING PADS.....12	FUSION FOAM66	MASKS..... 158
PSA DISC ROLLS13	SANDING SPONGES67	SAFETY GLASSES..... 158
BELTS	ANGLE SANDING SPONGE ...67	INDUSTRIAL WIPES 158
FILE BELTS.....14	FOAM SANDING PADS67	RESPIRATORS 159
PORTABLE BELTS.....15	ULTRAFLEX PADS.....67	LEATHER WORK GLOVES... 160
STANDARD BELTS16	MOUNTED POINTS.....68	DISPOSABLE COVERALLS.. 160
WIDE BELTS.....18	CARTRIDGE ROLLS70	BULLET EARPLUGS 160
PUMP SLEEVES20	FLAP WHEELS	LATEX GLOVES.....161
DRUM SLEEVES.....21	FLAP WHEELS71	NITRILE GLOVES 161
SHEETS	MOUNTING PLATES.....71	NITRILE-COATED FABRIC
STANDARD SHEETS22	SPINDLE-MOUNT FLAP WHEEL..72	GLOVES 161
BOARD FILE SHEETS25	MAC MOPS72	KEVLAR SLEEVES..... 161
ROLLS26	SPINDLE-MOUNT MACMOP ...72	SHOP ACCESSORIES
FLAP DISCS	SPINDLE-MOUNT BRUSH.....73	PADS, BITS & BLADES..... 162
TITAN DISCS29	BUFFING BRUSH74	SANDING BLOCKS 163
MINI SMT32	FLAP WHEELS FOR BUFFING..74	SPRAY GUNS.....164
SMT FLAP DISCS33	POLISHING	REPAIR TOOLS 166
CMT FLAP DISCS.....41	POLISHING WHEELS75	BUFFING PADS 167
FIBRE DISCS	POLISHING COMPOUND76	TAPES.....168
STANDARD FIBRE DISCS42	FELT PRODUCTS.....76	MASKING 169
QUICK LOCK FIBRE DISCS...43	SPIRAL BANDS.....77	BEDLINER KIT..... 170
BACKING PADS.....44	RUBBER DRUMS.....77	CLEANING PREP 170
BONDED ABRASIVES	WIRE PRODUCTS	FILTERS & WORKSTANDS ... 171
CUT-OFF WHEELS.....46	WIRE WHEELS & BRUSHES...78	REFERENCE
COMBO CUTTING	SCRATCH BRUSHES80	RECOMMENDATIONS 106
& GRINDING50	POWER WHEEL80	SAFETY GUIDELINES 106
GRINDING DISCS.....51	SPECIALTY	DISC HOLE PATTERN..... 172
QUICK CHANGE DISCS	SANDING STARS81	BELT SANDING MATERIAL.. 173
QDC (QUICK DISC CONNECT).....53	FLUTTER SHEETS81	SOLID SURFACE..... 175
QDC MANDRELS.....53	MANDRELS.....81	BONDED REFERENCE 176
QRC (ROLL), QMC (METAL),	VONNEGUT LOADINGS.....81	GRIT CHART 178
QSC (SCRIM BACK).....54	GRAPHITE STICKS81	
POWER DISCS54	BELT CLEANING STICKS81	
NON-WOVEN DISCS55	HD GRAPHITE ROLLS.....81	
QRC/QMC HOLDER PADS55	GREASE STICK81	
NON-WOVEN /	CUTTING AND FORMING	
BELTS.....60	ROUTER BITS94	
HAND PADS.....60	SAW BLADES..... 132	
DISCS61	JIGSAW BLADES..... 140	
EDGE-WORK DISCS.....61	CARBIDE BURRS 148	
ROLLS.....61		

Terms & Conditions

TERMS: Minimum \$100.00 order. Net 30 days from date of invoice. Invoices not paid within terms will be considered delinquent, and any orders will be placed on hold until delinquent invoices are paid.

DELIVERY: Single order shipments to one destination totaling \$300.00 or more will be shipped F.O.B. destination via carrier of our choice, continental U.S. only. Orders under \$300.00 will be shipped F.O.B. KLINGSPOR Distribution Point, continental U.S. only.

ALASKA & HAWAII SHIPMENTS: Shipments to Alaska or Hawaii will be prepaid only to the point of embarkation within the continental U.S., provided above conditions are met. NOTE: KLINGSPOR ABRASIVES cannot be held accountable for delays once an order is released to a carrier.

QUANTITY VARIANCE: Because of the nature of the manufacturing process, a ±10% variance will be allowed by the buyer to the manufacturer.

PRICING: All prices in this catalog are subject to correction and change without notice. All computer invoice extensions have been calculated utilizing two decimal places; therefore, there is the possibility that variations, however minor, may occur due to rounding, and shall be allowed by the buyer.

RETURN POLICY: Returns of merchandise will be accepted only with prior return authorization. Custom size items cannot be returned. All products authorized for return must be properly packaged and returned freight prepaid and in original packaging in re-sellable condition. We are not responsible for items ordered in error or overstocked; if any exceptions are made, a 20% restocking fee will apply. Material non-refundable after one year.

PRODUCT WARRANTY: KLINGSPOR ABRASIVES, Inc. warrants all products to be free from defects for up to one year. If any KLINGSPOR products are found to be defective, buyer's sole and exclusive remedy will be the replacement of any such products or, at KLINGSPOR's option, the refund of buyer's purchase price for said products. In any event, KLINGSPOR shall not be liable for any consequential damages.

What kinds of information do we collect and store?

- We collect information you or your company provide in our credit and customer profiles. Information such as financial, responsible parties, phone, address, credit card information (encrypted and only stored at the credit card processor) are only obtained from the customer submissions.
- Company's purchase history and items purchased.

How do we use the information collected?

- Purchase information is used for purposes of internal analysis and allowing customers to reorder from history on our website(s).
- Financial information provided by companies is used to determine credit worthiness and contact information for marketing and transactional purposes.
- We do not sell any customer information.

How can I manage or delete information about me?

- Right to Know: Contact us at CCPA@klingspor.com
- Right to Request Deletion: Contact us at CCPA@klingspor.com

Non-Discrimination: We will not discriminate against any user for exercising their rights.



PS 36 ALUMINA ZIRCONIA STEARATE PAPER

This C or D weight paper product from KLINGSPOR combines the effectiveness of Alumina Zirconia grains and a stearate coating with the leveling properties of paper. Excellent results can be achieved when sanding wood, metal, and various other substances including body fillers. PS 36 is a premium fully resin bonded product. [Semi-Open Coat](#)

KLING-ON® DISCS



AGGRESSIVE

Diameter	Grit	Price Per Box
5"	60	\$82.41
100/Box	40	\$92.74
50/Box	36	\$55.12
6"	60	\$106.45
100/Box	40	\$125.02
50/Box	36	\$73.22

PSA DISCS



Diameter	Grit	Price Per Box
5"	60	\$82.41
100/Box	40	\$92.74
50/Box	36	\$55.12
6"	60	\$106.45
100/Box	40	\$125.02
50/Box	36	\$73.22

PS 29 ALUMINUM OXIDE HEAVY PAPER WITH ACT

Aluminum Oxide open coat, resin-resin bond, F-weight paper, antistatic material. Works well in any application where loading is a problem on soft woods or mix of hard and soft wood. [Open Coat](#)

KLING-ON® DISCS

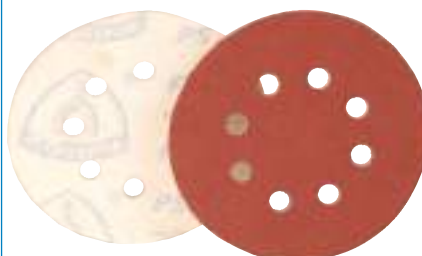

Diameter	Grit	Price Per Box
5"	60	\$89.77
50/Box	40	\$99.42
6"	60	\$132.58
50/Box	40	\$149.17

PSA DISCS



Diameter	Grit	Price Per Box
5"	60	\$132.56
100/Box	40	\$149.19
6"	60	\$195.88
100/Box	40	\$220.87
7"	60	\$276.16
100/Box	40	\$310.92
8"	60	\$179.53
50/Box	40	\$197.52

PS 21 ALUMINA ZIRCONIA F WEIGHT PAPER

Our longest lasting paper PSA disc. Offers long life in wood or metal applications.

PSA DISCS

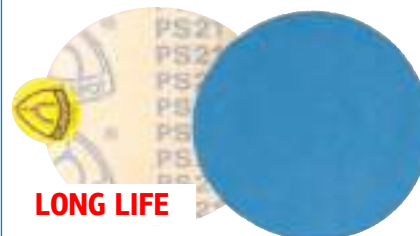

LONG LIFE

Diameter	Grit	Price Per Box
5"	60	\$157.27
50/Box	40	\$88.48
6"	60	\$232.65
50/Box	40	\$131.08
8"	60	\$213.62
50/Box	40	\$233.53

**For intermediate sizes use next higher list price.
Call for availability of other sizes.**

5% UPCHARGE ON DISCS WITH MORE THAN 10 HOLES

KLINGNET

Produced from a strong mesh net material and aluminum oxide grains, KlingNet is a premier product for use in marine, automotive, composites, and wood markets. KlingNet offers enhanced dust collection capabilities for a cleaner, safer work environment.

BEST DUST EXTRACTION



Diameter	Grit	Price Per Box
5" 50/Box	120-800	\$61.74
6" 50/Box	120-800	\$73.02

CS 310 X ALUMINUM OXIDE CLOTH

Aluminum Oxide, X cloth resin-resin bond, closed coat. Suitable for all ferrous metals, hardwoods, leather, aluminum, stainless steel, and most alloys.

KLING-ON® DISCS

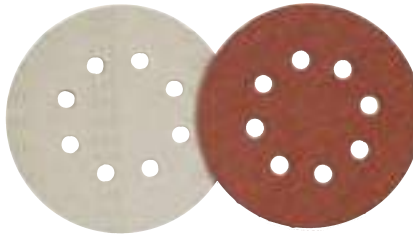

Diameter	Grit	Price Per Box
5"	60	\$150.97
50/Box	40	\$172.11
	36	\$182.60
	24	\$206.51
6"	60	\$209.20
50/Box	40	\$240.96
	36	\$256.81
	24	\$291.08

CS 710 XF HEAT TREATED ALUMINUM OXIDE CLOTH

Heat-treated Aluminum Oxide, X-Flex cloth resin-resin bond, closed coat. Suitable for polishing all ferrous metals and sanding on hardwoods.

KLING-ON® DISCS

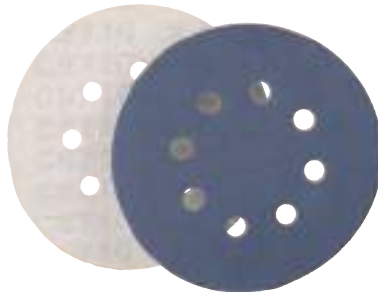

Diameter	Grit	Price Per Box
5"	100	\$134.37
50/Box	80	\$145.51
6"	100	\$187.93
50/Box	80	\$201.64

CLOTH PSA DISCS

CS 310: Aluminum Oxide, X cloth resin-resin bond, closed coat. Suitable for all ferrous metals, hardwoods, leather, aluminum, stainless steel, and most alloys.

CS 311 YX ACT: Aluminum Oxide, anti-static, poly/cotton, resin bonded, open coat material for wood sanding operations where clogging or loading is a problem and sanding of soft woods or mix of hard and soft woods.

CS 411 X: Alumina Zirconia resin-bonded, with backings available in both X-weight cloth (YX) or polyester cloth in Y-weight (Y) for high pressure, heavy stock removal on all types of metal, especially carbon and tool steels. Polyester backings can be used wet or dry.

- * 24-36 Grit - Add 47% to price shown
- * 40-60 Grit - Add 39% to price shown
- * 80 Grit & Finer - Add 33% to price shown

PSA DISCS



Diameter	Grit	Price Per Box
5"	60	\$83.28
50/Box	50	\$87.40
	40	\$91.51
	36	\$96.63
	24	\$108.98
6"	60	\$122.35
50/Box	50	\$129.89
	40	\$136.75
	36	\$144.88
	24	\$163.88
8"	60	\$222.07
50/Box	50	\$233.44
	40	\$244.79
	36	\$257.02
	24	\$289.97
10"	60	\$176.31
25/Box	50	\$187.15
	40	\$198.44
	36	\$207.67
	24	\$235.95
12"	60	\$103.45
10/Box	50	\$109.61
	40	\$116.18
	36	\$123.18
	24	\$138.19

For intermediate sizes use next higher list price. Call for availability of other sizes.

5% UPCHARGE ON DISCS WITH MORE THAN 10 HOLES

BLACKHOOK - PSA TO HOOK & LOOP CONVERSION



Quickly and easily convert your old PSA disc sanders to hook & loop sanders with this "hook" material. Simply determine what size and hole configuration you'll need and affix these pre-cut "hook" discs to your PSA backing pad. Comes in packages of 5.

Disc Size	Price Per Pack of 5
5" x No Hole	\$23.22
6" x No Hole	\$26.70
5" x 5 Hole	\$23.22
5" x 8 Hole	\$23.22
6" x 16 Hole	\$26.70
6" x 6 Hole	\$26.70
6" x 8 Hole	\$26.70

PS 61F CERAMIC ALUMINUM OXIDE HEAVY PAPER

KLING-ON® DISCS

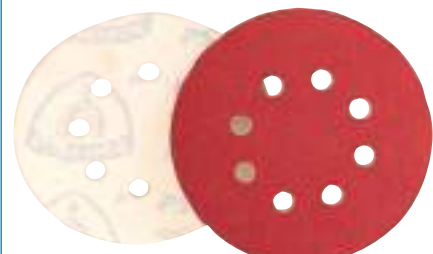

Ceramic Aluminum Oxide, F weight paper backing. Ceramic grains on a durable paper backing create a perfect combination of longevity and economy. Excellent intermediate and finishing properties for steel and stainless steel.

Diameter	Grit	Price Per Box
4"	120+	\$101.65
	80	\$106.38
	60	\$109.93
5"	120+	\$104.61
	80	\$109.93
	60	\$112.88
6"	120+	\$147.74
	80	\$158.38
	60	\$167.25

HEAVYWEIGHT PLAIN PAPER DISCS - PLAIN



PS 20: Primarily for grinding and polishing on metals, but also useful on leather. Closed coat, Aluminum Oxide, resin-resin bonded to heavy F-weight paper.

PS 22 ACT: For grinding and polishing metals and for finish sanding on hardwoods and leather. F-weight paper backing, Aluminum Oxide closed coat resin-resin bond.

PS 24 ACT: Fully resin-bonded Silicon Carbide material, F-weight paper backing. Works well for non-ferrous metal applications, sanding between coats of paint, lacquer, varnish, etc. in woodworking applications, or for finish sanding of particle board or MDF. *Add 10% to price shown

PS 29 ACT: Aluminum Oxide open coat, resin-resin bond, F-weight paper, antistatic material. Works well in any application where loading is a problem on soft woods or mix of hard and soft wood.

PS 61: Ceramic Aluminum Oxide, F weight paper backing. Ceramic grains on a durable paper backing create a perfect combination of longevity and economy. Excellent intermediate and finishing properties for steel and stainless steel. *Add 40% to price shown

Diameter	Grit	Price Per Box
4"	100+	\$34.62
	80	\$37.26
	60	\$39.80
5"	100+	\$47.49
	80	\$50.54
	60	\$57.79
6"	100+	\$70.62
	80	\$65.48
	60	\$78.31
7"	100+	\$97.59
	80	\$105.08
	60	\$116.90
8"	100+	\$119.45
	80	\$126.04
	60	\$141.10

PL 28 ALUMINUM OXIDE HEAVY PAPER

KLING-ON® DISCS

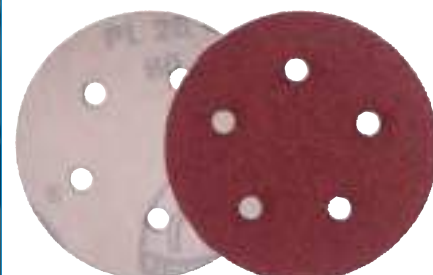

ECONOMY PRODUCT - KLING-ON ONLY

Aluminum Oxide closed coat, resin-resin bond, C-weight paper. Works well on wood, metal and solid surface materials.

Diameter	Grit	Price Per Box
5"	80	\$26.14
	60	\$28.51
6"	80	\$34.21
	60	\$36.39

5% UPCHARGE ON DISCS WITH MORE THAN 10 HOLES



PS 33 ALUMINUM OXIDE STEARATE PAPER

Aluminum Oxide B or C-weight paper, resin-resin bond for bare wood sanding, autobody use, sanding of bare metal, primer, primer surfacer, between coats of paint, and sanding of solid surface materials. *Semi-Open Coat*

KLING-ON® DISCS



Diameter	Grit	Price Per Box
4"	60	\$67.05
100/Box	40	\$75.46
4-1/2"	60	\$67.05
100/Box	40	\$75.46
5"	60	\$67.05
100/Box	40	\$75.46
6"	60	\$86.59
100/Box	40	\$112.83
8"	60	\$76.96
50/Box	40	\$99.65
11"	60	\$151.50
25/Box	40	\$162.84

PSA DISCS



Diameter	Grit	Price Per Box
4"	60	\$67.05
100/Box	40	\$75.46
4-1/2"	60	\$67.05
100/Box	40	\$75.46
5"	60	\$67.05
100/Box	40	\$75.46
6"	60	\$86.59
100/Box	40	\$112.83
8"	60	\$76.96
50/Box	40	\$99.65

PLAIN CLOTH DISCS - NON PSA



LS 309: Aluminum Oxide, fully resin bonded, J or J-flex cotton cloth for polishing ferrous or non-ferrous metals and hardwoods where belt conformability to the work piece is required.

CS 310: Aluminum Oxide, X or X-Flex cloth resin-resin bond, closed coat. Suitable for all ferrous metals, hardwoods, leather, aluminum, stainless steel, and most alloys.

CS 311 YX ACT: Aluminum Oxide, anti-static, poly/cotton, resin bonded, open coat material for wood sanding operations where clogging or loading is a problem and sanding of soft woods or mix of hard and soft woods.

CS 321: Waterproof Silicon Carbide X-weight cloth resin bonded for grinding and polishing of glass, non-ferrous metals, plastics, stone, marble, grey cast iron, and titanium. Specially treated for use with water or water-based coolants.

PLEASE ADD 5% TO PRICE SHOWN

CS 411 X; CS 411YX, Y: Alumina Zirconia resin-bonded, with backings available in both X-weight cloth (YX) or polyester cloth in Y-weight (Y) for high pressure, heavy stock removal on all types of metal, especially carbon and tool steels. Polyester backings can be used wet or dry.

- ** 24-36 Grit - Add 47% to price shown
- ** 40-60 Grit - Add 39% to price shown
- ** 80 Grit - Add 33% to price shown
- ** 120 Grit - Add 33% to price shown



Diameter	Grit	Price Per Box
8"	100+	\$160.08
	50/Box	80 \$167.70
		60 \$180.18
		50 \$192.80
		40 \$205.40
	36 \$219.33	
9"	100+	\$205.40
	50/Box	80 \$215.59
		60 \$231.86
		50 \$245.84
		40 \$256.01
	36 \$281.08	
10"	100+	\$126.66
	25/Box	80 \$132.96
		60 \$135.64
		50 \$143.94
		40 \$152.64
	36 \$156.92	
12"	100+	\$73.86
	10/Box	80 \$77.64
		60 \$83.69
		50 \$88.74
		40 \$94.54
	36 \$101.08	



PS 36 ALUMINA ZIRCONIA STEARATE PAPER

This C or D weight paper product from KLINGSPOR combines the effectiveness of Alumina Zirconia grains and a stearate coating with the leveling properties of paper. Excellent results can be achieved when sanding wood, metal, and various other substances including body fillers. PS 36 is a premium fully resin bonded product. [Semi-Open Coat](#)

KLING-ON® DISCS

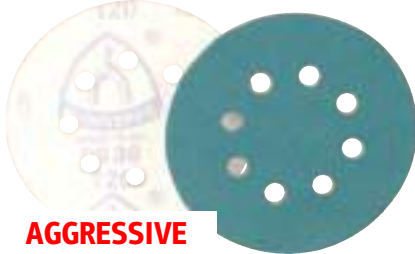

AGGRESSIVE

Diameter	Grit	Price Per Box
5"	100+	\$72.13
100/Box	80	\$75.59
6"	100+	\$94.47
100/Box	80	\$98.88

PSA DISCS



Diameter	Grit	Price Per Box
5"	100+	\$72.13
100/Box	80	\$75.59
6"	100+	\$94.47
100/Box	80	\$98.88

PS 29 ALUMINUM OXIDE HEAVY PAPER WITH ACT

Aluminum Oxide open coat, resin-resin bond, F-weight paper, antistatic material. Works well in any application where loading is a problem on soft woods or mix of hard and soft wood. [Open Coat](#)

KLING-ON® DISCS

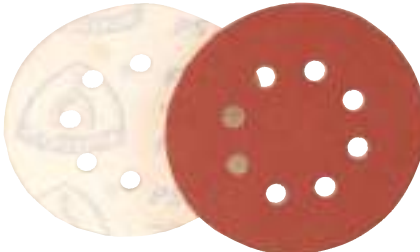

Diameter	Grit	Price Per Box
4"	100+	\$87.22
50/Box	80	\$87.22
5"	100+	\$82.89
50/Box	80	\$87.03
6"	100+	\$117.40
50/Box	80	\$125.67

PSA DISCS

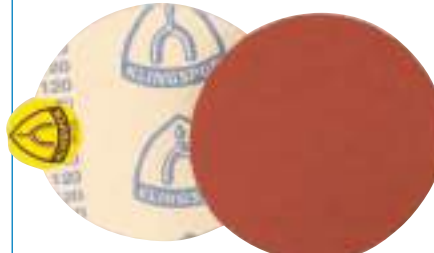

Diameter	Grit	Price Per Box
5"	100+	\$121.59
100/Box	80	\$127.04
6"	100+	\$176.76
100/Box	80	\$185.03
7"	100+	\$246.69
100/Box	80	\$275.84
8"	100+	\$161.05
50/Box	80	\$171.24

Call for availability of other sizes.

PS 21 ALUMINA ZIRCONIA F WEIGHT PAPER

Our longest lasting paper PSA disc. Offers long life in wood or metal applications.

PSA DISCS

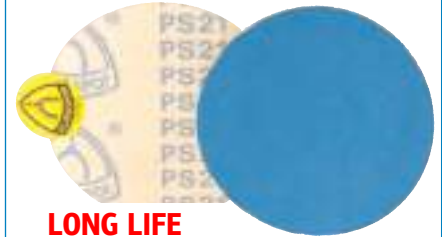

LONG LIFE

Diameter	Grit	Price Per Box
5"	100+	\$144.17
100/Box	80	\$150.72
6"	100+	\$209.64
100/Box	80	\$219.50
7"	100+	\$328.44
100/Box	80	\$315.20
8"	100+	\$191.74
50/Box	80	\$203.17

LS 312 ALUMINUM OXIDE DRY-LUBE JF WEIGHT CLOTH

PSA DISCS



Aluminum Oxide, semi-open coat resin bonded with a special top coating to aid in cooling and to resist loading. Very flexible, J-Flex cloth backing for severely contoured workpieces. Best suited for polishing stainless steel and high alloy steels, other ferrous metals and non-ferrous metals.

Diameter	Grit	Price Per Box
5"		\$85.24
50/Box	120-220	
6"		\$123.76
50/Box	120-220	

VP 73W ALUMINUM OXIDE STEARATE LATEX PAPER

Enhanced 73W material with a latex impregnated backing for longer edgewear and life. May be used anywhere the regular PS33 is found including bare wood, composite, marine and autobody. This material is not waterproof.

KLING-ON® DISCS



Diameter	Grit	Price Per Box
5"	100+	\$66.69
100/Box	80	\$69.95
6"	100+	\$87.36
100/Box	80	\$93.79
8"	100+	\$77.32
50/Box	80	\$81.23

PSA DISCS



Diameter	Grit	Price Per Box
5"	100+	\$66.69
100/Box	80	\$69.95
6"	100+	\$87.36
100/Box	80	\$93.79
8"	100+	\$77.32
50/Box	80	\$81.23

FP 77 GREEN TEC ALUMINUM OXIDE FILM

Aluminum Oxide on a 3 mil poly film in grits 80-2000. KLINGSPOR's proprietary coating technology makes this product the perfect choice when loading is an issue. Available in discs, sheets and rolls. FP 77 is waterproof. [Semi-Open Coat](#)

KLING-ON® DISCS



Diameter	Grit	Price Per Box
5"	100 - 2000	\$86.69
100/Box	80	\$91.08
6"	100 - 2000	\$113.50
100/Box	80	121.90

PSA DISCS



Diameter	Grit	Price Per Box
5"	100 - 2000	\$86.69
100/Box	80	\$90.92
6"	100 - 2000	\$113.50
100/Box	80	\$121.90

SOFT HAND PADS



These hand pads are used in most woodworking hand operations to create a softer scratch that leads to better finishing.

5" Hook & Loop Foam Hand Pad
1/8" Thick with Strap
FJ2215 \$12.13

5" PSA Foam Hand Pad
1/8" Thick with Strap
FJ2115 \$12.13

FP 77 WATERPROOF

Applications:

Fiberglass, Composites, Wood & Wood Finishes, Aluminum, Painted Surfaces

Advantages:

- Longer, more consistent cut
- Better overall finishes
- Reduced heat
- Consistent, blemish-free finishes
- Tighter, more consistent scratch
- Substantially less loading than traditional stearate products

PS 33 ALUMINUM OXIDE STEARATE PAPER

Aluminum Oxide B or C-weight paper, resin-resin bond for bare wood sanding, autobody use, sanding of bare metal, primer, primer surfacer, between coats of paint, and sanding of solid surface materials.
Semi-Open Coat

KLING-ON® DISCS



Diameter	Grit	Price Per Box
4"	100+	\$58.65
100/Box	80	\$61.47
4-1/2"	100+	\$58.65
100/Box	80	\$61.47
5"	100+	\$58.65
100/Box	80	\$61.48
6"	100+	\$76.86
100/Box	80	\$80.46
8"	100+	\$68.00
50/Box	80	\$71.44
11"	100+	\$129.71
25/Box	80	\$150.17

PSA DISCS



Diameter	Grit	Price Per Box
4"	100+	\$58.65
100/Box	80	\$61.47
4-1/2"	100+	\$58.65
100/Box	80	\$61.47
5"	100+	\$58.65
100/Box	80	\$61.47
6"	100+	\$76.86
100/Box	80	\$80.47
8"	100+	\$68.00
50/Box	80	\$71.44

KLINGNET

Produced from a strong mesh net material and aluminum oxide grains, KlingNet is a premier product for use in marine, automotive, composites, and wood markets. KlingNet offers enhanced dust collection capabilities for a cleaner, safer work environment.

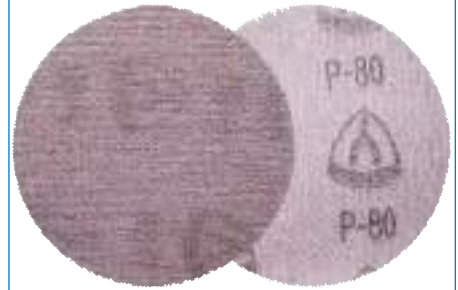

Diameter	Grit	Price Per Box
5" 50/Box	80-800	\$63.53
6" 50/Box	80-800	\$75.14



WATCH MORE
KLING NET
IN ACTION



PS 11 SILICON CARBIDE WATERPROOF A/C WEIGHT LATEX PAPER

Waterproof Silicon Carbide, A and C-weight papers, resin-resin bonded and available in grits P60 - P2000. Use for sanding of furniture finishes such as varnish, lacquer, shellac, oil, polishing of glass, and in automotive body shops for final color sanding of paint.

KLING-ON® DISCS

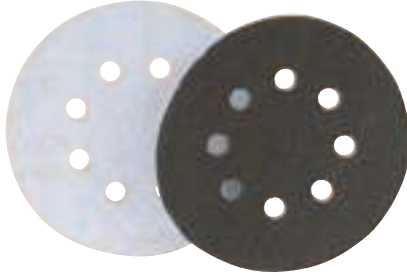

Diameter	Grit	Price Per Box
5"	220+	\$100.06
	100/Box	180 \$107.97
		150 \$110.57
		120 \$121.59
		100 \$132.56
6"	220+	\$144.82
	100/Box	180 \$152.69
		150 \$160.62
		120 \$176.71
		100 \$193.33
11"	220+	\$223.00
	25/Box	180 \$230.65
		150 \$259.87
		120 \$272.60

PSA DISCS



PREMIUM FINISHING

Diameter	Grit	Price Per Box
3-1/2"	220	\$83.82
	100/Box	180 \$85.00
		150 \$88.52
		120 \$93.26
		100 \$102.84
4"	220	\$86.91
	100/Box	180 \$90.47
		150 \$95.64
		120 \$102.67
		100 \$111.14
5"	220	\$100.27
	100/Box	180 \$105.59
		150 \$111.45
		120 \$117.08
		100 \$127.95
6"	220	\$144.12
	100/Box	180 \$152.26
		150 \$160.37
		120 \$168.46
		100 \$184.37
8"	220	\$139.54
	50/Box	180 \$146.13
		150 \$151.23
		120 \$163.24
		100 \$182.25

CS 710 XF HEAT TREATED ALUMINUM OXIDE CLOTH

Heat-treated Aluminum Oxide, X-Flex cloth resin-resin bond, closed coat. Suitable for polishing all ferrous metals and sanding on hardwoods.

KLING-ON® DISCS

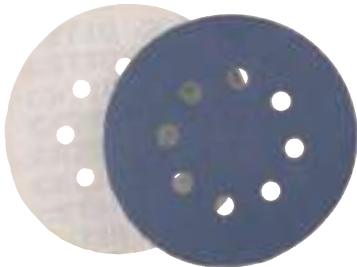

Diameter	Grit	Price Per Box
5"	100-180, 240	\$134.36
50/Box		
6"	100-180, 240	\$187.93
50/Box		

CLOTH PSA DISCS



CS 310: Aluminum Oxide, X or X-Flex cloth resin-resin bond, closed coat. Suitable for all ferrous metals, hardwoods, leather, aluminum, stainless steel, and most alloys.

CS 311 YX ACT: Aluminum Oxide, anti-static, poly/cotton, resin bonded, open coat material for wood sanding operations where clogging or loading is a problem and sanding of soft woods or mix of hard and soft woods.

Diameter	Grit	Price Per Box
3"	100+	\$51.97
	50/Box	80 \$53.88
4"	100+	\$63.75
	50/Box	80 \$66.87
5"	100+	\$74.93
	50/Box	80 \$79.18
6"	100+	\$108.98
	50/Box	80 \$115.17
8"	100+	\$201.83
	50/Box	80 \$211.82
10"	100+	\$156.77
	25/Box	80 \$166.56
12"	100+	\$91.92
	10/Box	80 \$97.46
20"	100+	\$78.29
	3/Box	80 \$82.97

For intermediate sizes use next higher list price.

Call for availability of other sizes.

FP 77 GREEN TEC ALUMINUM OXIDE FILM

Aluminum Oxide on a 3 mil poly film in grits 60-2000. KLINGSPOR's proprietary coating technology makes this product the perfect choice when loading is an issue. Available in discs, sheets and rolls. FP 77 is waterproof. **Semi-Open Coat**

KLING-ON® DISCS



BEST

Diameter	Grit	Price Per Box
5"	100 - 2000	\$86.69
	80	\$91.08
6"	100 - 2000	\$113.50
	80	\$121.90

PSA DISCS



Diameter	Grit	Price Per Box
5"	100 - 2000	\$86.69
	80	\$90.92
6"	100 - 2000	\$113.50
	80	\$121.90

PS 33 ALUMINUM OXIDE STEARATE PAPER

Aluminum Oxide B or C-weight paper, resin-resin bond for bare wood sanding, autobody use, sanding of bare metal, primer, primer surfacer, between coats of paint, and sanding of solid surface materials. **Semi-Open Coat**

KLING-ON® DISCS



GOOD

Diameter	Grit	Price Per Box
4"	100+	\$58.65
	80	\$61.47
	60	\$67.05
	40	\$75.46
5"	100+	\$58.65
	80	\$61.47
	60	\$67.05
	40	\$75.46
6"	100+	\$76.86
	80	\$80.46
	60	\$86.59
	40	\$112.83
8"	100+	\$68.00
	80	\$71.44
	60	\$76.96
	40	\$99.65
11"	100+	\$129.71
	80	\$150.17
	60	\$151.50
	40	\$162.84

PSA DISCS



Diameter	Grit	Price Per Box
4"	100+	\$58.65
	80	\$61.47
	60	\$67.05
	40	\$75.46
5"	100+	\$58.65
	80	\$61.47
	60	\$67.05
	40	\$75.46
6"	100+	\$76.86
	80	\$80.47
	60	\$86.59
	40	\$112.83
8"	100+	\$68.00
	80	\$71.44
	60	\$76.96
	40	\$99.65



WATCH MORE
GREEN TEC
 IN ACTION

VP 73W ALUMINUM OXIDE STEARATE LATEX PAPER

Enhanced 73W material with a latex impregnated backing for longer edgewear and life. May be used anywhere the regular PS33 is found including bare wood, composite, marine and autobody. This material is not waterproof.

KLING-ON® DISCS



EDGEWEAR

Diameter	Grit	Price Per Box
5"	100+	\$66.69
100/Box	80	\$69.95
6"	100+	\$87.36
100/Box	80	\$93.79
8"	100+	\$77.32
50/Box	80	\$81.23

PSA DISCS



Diameter	Grit	Price Per Box
5"	100+	\$66.69
100/Box	80	\$69.95
6"	100+	\$87.36
100/Box	80	\$93.79
8"	100+	\$77.32
50/Box	80	\$81.23

PS 35 SILICON CARBIDE STEARATE B WEIGHT PAPER

B-weight Silicon Carbide paper, resin bonded, open coat top-coated with Zinc Stearate dry lubricant.

Suitable for sanding contoured surfaces or flat surfaces by hand, with sanding blocks, or on vibrating sanders. Ideal for sanding primer, paint, bare metal, and rust, or in woodworking, for sanding sealer, wash coats, bare softwoods and hardwoods, and between coats of furniture finishes.

KLING-ON® DISCS



Diameter	Grit	Price Per Box
5"	120+	\$51.12
100/Box	80	\$56.39
6"	120+	\$67.40
100/Box	80	\$74.08

PSA DISCS



SANDING FINISHES

Diameter	Grit	Price Per Box
5"	120+	\$51.12
100/Box	80	\$56.39
6"	120+	\$67.40
100/Box	80	\$74.08

KLINGSPOR BACKING PADS

5" Kling-On
No Hole
SBP5K.....\$24.97

5" Kling-On
Multi-Hole
SBP5KMP..\$33.23

5" PSA
No Hole
SBP5P.....\$24.97

6" Kling-On
No Holes
SBP6K.....\$28.26

6" Kling-On
Multi-Hole
SBP6KMP..\$47.47

6" PSA
No Holes
SBP6P.....\$28.26



PREMIUM BACKING PADS



- 5" x No Hole Hook & Loop
FJ70515.....\$27.08
- 5" x 5 Hole Hook & Loop
FJ70515-H5.....\$27.08
- 5" x No Hole PSA
FJ70515V.....\$38.23
- 6" x No Hole Hook & Loop
FJ70516.....\$30.96

PS 33 ALUMINUM OXIDE STEARATE B/C WEIGHT PAPER

Aluminum Oxide B or C-weight paper, resin-resin bond for bare wood sanding, autobody use, sanding of bare metal, primer, primer surfacer, between coats of paint, and sanding of solid surface materials.



Diameter	Grit	Price Per Roll
5"	100+	\$58.67
100/Roll	80	\$61.46
6"	100+	\$76.86
100/Roll	80	\$80.45

PS 36 ALUMINA ZIRCONIA STEARATE C/D WEIGHT PAPER

This C or D weight paper product from KLINGSPOR combines the effectiveness of Alumina Zirconia grains and a stearate coating with the leveling properties of paper. Excellent results can be achieved when sanding wood, metal, and various other substances including body fillers. PS 36 is a premium fully resin bonded product.



Diameter		Grit	Price Per Roll
5"	100/Roll	120+	\$72.12
		80	\$75.55
		60	\$82.41
6"	100/Roll	120+	\$94.45
		80	\$98.89
		60	\$106.45

Minimum order of 3 on Non-Stock Disc Rolls

PS 35 SILICON CARBIDE STEARATE B WEIGHT PAPER

B-weight Silicon Carbide paper, resin bonded, open coat top-coated with Zinc Stearate dry lubricant. Suitable for sanding contoured surfaces or flat surfaces by hand, with sanding blocks, or on vibrating sanders. Ideal for sanding primer, paint, bare metal, and rust, or in woodworking, for sanding sealer, wash coats, bare softwoods and hardwoods, and between coats of furniture finishes.



Diameter	Grit	Price Per Roll
5"	120+	\$51.13
100/Roll	80	\$56.39
6"	120+	\$65.94
100/Roll	80	\$74.09



PS 11 SILICON CARBIDE WATERPROOF A/C WEIGHT LATEX PAPER

Waterproof Silicon Carbide, A and C-weight papers, resin-resin bonded and available in grits P60 - P2000. Use for sanding of furniture finishes such as varnish, lacquer, shellac, oil, polishing of glass, and in automotive body shops for final color sanding of paint.

Easily dispense these discs for wet applications.

Diameter	Grit	Price Per Roll
5"	220+	\$100.27
	180	\$105.58
	150	\$111.45
	120	\$117.07
	100	\$127.93
	80	\$134.65
6"	60	\$141.34
	220+	\$144.13
	180	\$152.25
	150	\$160.36
	120	\$168.46
	100	\$184.36
100/Roll	80	\$195.52
	60	\$207.55



Disc Roll Dispenser #DISPENSER981 \$74.61

FILE BELTS

CS 308: Our YX weight Aluminum Oxide material is a fully resin-bonded product. Use on ferrous or non-ferrous metals and on hardwoods.

CS 310: Aluminum Oxide, X-Flex cloth resin-resin bond, closed coat. Suitable for all ferrous metals, hardwoods, leather, aluminum, stainless steel, and most alloys.

CS 412: Aluminum Oxide, resin bonded, Y-weight (Y), and X-weight (YX), polyester-backings for use wet or dry on ferrous or non-ferrous metals. Also suitable for sanding hardwoods.

CS 710: Heat-treated Aluminum Oxide, X-Flex cloth resin-resin bond, closed coat. Suitable for polishing all ferrous metals and sanding on hardwoods.

Belt Size	Grit	Price Per Box
* 1/8" x 12", 1/4" x 12", 1/2" x 12"		
10/Box	100+	\$15.59
	80	\$15.59
	60	\$15.59
	50	\$15.59
	40	\$15.59
* 1/8" x 18", 1/4" x 18", 1/2" x 18"		
10/Box	100+	\$17.27
	80	\$17.27
	60	\$17.27
	50	\$17.27
	40	\$17.27
1/4" x 20-1/2", 1/2" x 20-1/2"		
10/Box	100+	\$18.97
	80	\$18.97
	60	\$18.97
	50	\$18.97
	40	\$18.97
* 1/8" x 24", 1/4" x 24", 1/2" x 24"		
10/Box	100+	\$20.72
	80	\$20.72
	60	\$20.72
	50	\$20.72
	40	\$20.72
1/4" x 30", 1/2" x 30"		
10/Box	100+	\$22.44
	80	\$22.44
	60	\$22.44
	50	\$22.44
	40	\$22.44
3/8" x 13"		
10/Box	100+	\$16.79
	80	\$16.79
	60	\$16.79
	50	\$16.79
	40	\$16.79
5/8" x 18", 3/4" x 18"		
10/Box	100+	\$20.95
	80	\$20.95
	60	\$20.95
	50	\$20.95
	40	\$20.95
5/8" x 20-1/2", 3/4" x 20-1/2"		
10/Box	100+	\$22.44
	80	\$22.44
	60	\$22.44
	50	\$22.44
	40	\$22.44
5/8" x 24", 3/4" x 24"		
10/Box	100+	\$24.12
	80	\$24.12
	60	\$24.12
	50	\$24.12
	40	\$24.12

PREMIUM FILE BELTS

CS 409: Alumina Zirconia grain with a multi-bond additive on polyester backing for grinding high alloys such as titanium and metals like stainless steel where heat build-up is a problem.

CS 411 Y: Alumina Zirconia resin-bonded, polyester cloth Y-weight (Y) backing for high pressure, heavy stock removal on all types of metal, especially carbon and tool steels. Polyester backings can be used wet or dry.

CS 416: 100% Alumina Zirconia semi-open coat on a heavy or extra heavy polyester backing for high pressure production situations grinding steel, stainless steel, non-ferrous metals, plastic, leather and wood planing.

Belt Size	Grit	Price Per Box
*1/8" x 12", 1/4" x 12", 1/2" x 12"		
10/Box	100+	\$20.72
	80	\$20.72
	60	\$20.72
	50	\$20.72
	40	\$20.72
*1/8" x 18", 1/4" x 18", 1/2" x 18"		
10/Box	100+	\$22.44
	80	\$22.44
	60	\$22.44
	50	\$22.44
	40	\$22.44
1/4" x 20-1/2", 1/2" x 20-1/2"		
10/Box	100+	\$24.39
	80	\$24.39
	60	\$24.39
	50	\$24.39
	40	\$24.39
*1/8" x 24", 1/4" x 24", 1/2" x 24"		
10/Box	100+	\$25.81
	80	\$25.81
	60	\$25.81
	50	\$25.81
	40	\$25.81
1/4" x 30", 1/2" x 30"		
10/Box	100+	\$27.51
	80	\$27.51
	60	\$27.51
	50	\$27.51
	40	\$27.51
3/8" x 13"		
10/Box	100+	\$21.96
	80	\$21.96
	60	\$21.96
	50	\$21.96
	40	\$21.96
5/8" x 18", 3/4" x 18"		
10/Box	100+	\$25.05
	80	\$25.05
	60	\$25.05
	50	\$25.05
	40	\$25.05
5/8" x 20-1/2", 3/4" x 20-1/2"		
10/Box	100+	\$27.00
	80	\$27.00
	60	\$27.00
	50	\$27.00
	40	\$27.00
5/8" x 24", 3/4" x 24"		
10/Box	100+	\$29.24
	80	\$29.24
	60	\$29.24
	50	\$29.24
	40	\$29.24

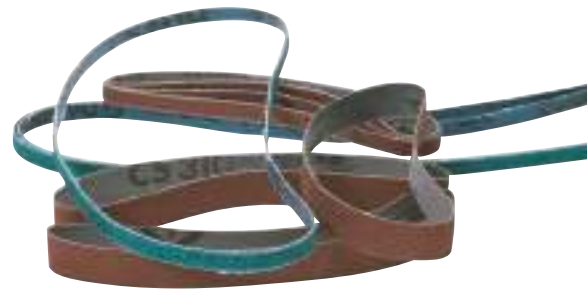

CERAMIC FILE BELTS*



CS 631 XF: Ceramic Aluminum Oxide on either X-flex backing or very flexible J-flex backing. Perfect for use on steels of all types but specifically for hard steels and under high grinding pressure. Added multibond lubricant enhances grinding properties and reduces heat build-up.

CS 920 ACT: Ceramic Aluminum Oxide with multibond lubricant added to enhance the grinding properties and cool the grinding surface. Features a heavy polyester backing that enhances its durability while removing large amounts of stock.

CS 922 ACT: Ceramic Aluminum Oxide on our heaviest YY polyester backing for use on steels of all types and under high grinding pressure applications.

Belt Size	Grit	Price Per Box
1/4" x 18", 1/2" x 18"	180-100	\$25.80
	80	\$25.80
	60	\$25.80
	50	\$25.80
	40	\$25.80
1/4" x 20-1/2", 1/2" x 20-1/2"	100+	\$28.06
	80	\$28.06
	60	\$28.06
	50	\$28.06
	40	\$28.06
1/4" x 24", 1/2" x 24"	100+	\$29.73
	80	\$29.73
	60	\$29.73
	50	\$29.73
	40	\$29.73
5/8" x 18", 3/4" x 18"	100+	\$28.85
	80	\$28.85
	60	\$28.85
	50	\$28.85
	40	\$28.85
5/8" x 24", 3/4" x 24"	100+	\$33.59
	80	\$33.59
	60	\$33.59
	50	\$33.59
	40	\$33.59

PREMIUM PORTABLE BELTS



The ultimate in life and consistency. Premium components offer extended use in wood sanding applications.

CS 311 YX ACT: Aluminum Oxide, anti-static, poly/cotton, resin bonded, open coat material for wood sanding operations where clogging or loading is a problem and sanding of soft woods or mix of hard and soft woods.

Belt Size	Grit	Box Price	Belt Size	Grit	Box Price	Belt Size	Grit	Box Price			
1" x 42"	100+	\$38.17	3" x 21"	100+	\$27.92	4" x 24"	100+	\$37.24			
	10/Box	80		\$38.64	10/Box		80	\$37.71	10/Box	80	\$37.71
		60		\$40.84			60	\$29.54		60	\$39.33
5/Box	40	\$21.18	5/Box	40	\$15.83	5/Box	40	\$20.94			
2" x 48"	100+	\$56.09	3" x 24"	100+	\$29.32	4" x 36"	100+	\$93.56			
	10/Box	80		\$57.71	10/Box		80	\$30.05	10/Box	80	\$96.35
		60		\$60.73			60	\$31.39		60	\$100.52
5/Box	40	\$32.80	5/Box	40	\$16.88	5/Box	40	\$54.22			
3" x 18"	100+	\$26.54	4" x 21"	100+	\$73.55	6" x 48"	100+	\$164.30			
	10/Box	80		\$27.69	10/Box		80	\$75.20	10/Box	80	\$169.87
		60		\$28.16			60	\$77.74		60	\$178.25
5/Box	40	\$15.02	5/Box	40	\$41.19	5/Box	40	\$97.16			

PORTABLE BELTS



Most economical woodworking belt. NOTE: If you are doing edge work in 40 - 60 grit, the CS311 or CS308 would be a better value

LS 309 XH: Aluminum Oxide, resin bonded, lightweight X weight cotton cloth for sanding ferrous and non-ferrous metals, and both hard and soft woods. Portable belts only.

Belt Size	Grit	Box Price	Belt Size	Grit	Box Price	Belt Size	Grit	Box Price			
1" x 42"	100+	\$24.55	3" x 21"	100+	\$26.78	4" x 24"	100+	\$35.73			
	10/Box	80		\$25.05	10/Box		80	\$27.26	10/Box	80	\$36.19
		60		\$26.03			60	\$28.35		60	\$37.73
	50	\$26.75		50	\$29.03		50	\$39.28			
5/Box	40	\$13.87	5/Box	40	\$15.18	5/Box	40	\$20.09			
2" x 48"	100+	\$38.80	3" x 24"	100+	\$28.13	4" x 36"	100+	\$52.07			
	10/Box	80		\$40.03	10/Box		80	\$28.83	10/Box	80	\$54.03
		60		\$41.76			60	\$30.14		60	\$55.98
	50	\$43.70		50	\$31.90		50	\$58.44			
5/Box	40	\$22.72	5/Box	40	\$16.19	5/Box	40	\$30.20			
3" x 18"	100+	\$25.46	4" x 21"	100+	\$40.03	6" x 48"	100+	\$102.89			
	10/Box	80		\$26.57	10/Box		80	\$40.51	10/Box	80	\$106.82
		60		\$27.02			60	\$41.99		60	\$111.72
	50	\$28.13		50	\$43.46		50	\$117.13			
5/Box	40	\$14.41	5/Box	40	\$17.58	5/Box	40	\$61.02			

PLANER BELTS



Perfect for heavy stock removal. Use for planing wood or smoothing metal surfaces.

CS 411: Alumina Zirconia resin-bonded, with backings available in Y-weight (Y) for high pressure, heavy stock removal on all types of metal, especially carbon and tool steels. Polyester backings can be used wet or dry.

Size	Grit/Item#	Box Price	Size	Grit/Item#	Box Price	Size	Grit/Item#	Box Price			
3" x 18"	411120X03001804	\$61.10	3" x 24"	120	\$47.24	4" x 24"	120	\$77.49			
	10/Box	411080X03001804		\$63.10	10/Box		80	\$48.64	10/Box	80	\$79.59
		411060X03001804		\$65.80			60	\$50.96		60	\$82.37
5/Box	411040X03001804	\$22.83	5/Box	40	\$27.35	5/Box	40	\$43.75			
	411036X03001804	\$24.67			36		\$29.54		36	\$47.26	
	411024X03001804	\$26.64			24		\$31.91		24	\$51.04	
3" x 21"	411120Y03002104	\$44.21									
	10/Box	411080Y03002104	\$45.38								
		411060Y03002104	\$47.47								
5/Box	411040Y03002104	\$25.35									
	411036Y03002104	\$27.40									
	411024Y03002104	\$29.59									

CLOTH BELTS

CS 308: Our YX weight Aluminum Oxide material is a fully resin-bonded product that offers the benefits of a polyester backing in an X-weight. Use on ferrous or non-ferrous metals and on hardwoods. CS 308 has an extended grit range that allows for coarse to ultra-fine belt sanding and polishing.

LS 309: Aluminum Oxide, fully resin bonded, J or J-flex cotton cloth for polishing ferrous or non-ferrous metals and hardwoods where belt conformability to the work piece is required. Narrow belts and some intermediate belts. XH backing is for portable belts only.

CS 310: Aluminum Oxide, X or X-Flex cloth resin-resin bond, closed coat. Suitable for all ferrous metals, hardwoods, leather, aluminum, stainless steel, and most alloys.

CS 311 YX ACT: Aluminum Oxide, anti-static, poly/cotton, resin bonded, open coat material for wood sanding operations where clogging or loading is a problem and sanding of soft woods or mix of hard and soft woods.

LS 312: Aluminum Oxide, semi-open coat resin bonded with a special top coating to aid in cooling and to resist loading. Very flexible, J-Flex cloth backing for severely contoured workpieces. Best suited for polishing stainless steel and high alloy steels, other ferrous metals and non-ferrous metals.

LS 313: Aluminum Oxide, semi-open coat, highly flexible J-flex backing, fully resin-bonded with a dry lubricant to reduce heat and clogging on stainless steel, aluminum, and titanium grinding and finishing.

CS 320: Silicon Carbide on Y-weight polyester backings. Excellent for wet applications on glass, plastic, and stainless steels where strength of polyester would be a benefit.

CS 321: Waterproof Silicon Carbide X-weight cloth resin bonded for grinding and polishing of glass, non-ferrous metals, plastics, stone, marble, grey cast iron, and titanium. Specially treated for use with water or water-based coolants.

CS 333: A versatile Silicon Carbide, fully resin bonded, X, J, or J-Flex cloth backings for grinding and polishing of non-ferrous metals, grinding and polishing of plastic, glass, rubber, fiberglass, stone, marble, and grey cast iron.

CS 341: Waterproof Aluminum Oxide fully resin bonded X-weight cloth for metal grinding and polishing where water or soluble oil coolants are used to reduce heat.

CS 412: Aluminum Oxide, resin bonded, Y-weight (Y), and X-weight (YX), polyester-backings for use wet or dry on ferrous or non-ferrous metals. Also suitable for sanding hardwoods.

CS 538 ACT: Silicon Carbide, polyester backing and closed coat grain coverage make this a preferred product for the particle board and plywood industries. For wide belts only.

CS 710: Heat-treated Aluminum Oxide, X-Flex cloth resin-resin bond, closed coat. Suitable for polishing all ferrous metals and sanding on hardwoods.

GX 533 JF: Silicon Carbide grains resin-bonded to a new tough polyester/cotton blended backing with high flexibility and extra durability. Perfect on non-ferrous metals.

GX 712 JF: Aluminum oxide resin bonded to a new tough polyester/cotton blended backing with high flexibility and extra durability. A multibond lubricant is added for cooler grinding and better finishes on ferrous and non-ferrous metals.

* Add 5% to price shown
 ** Add 10% to price shown
 *** Add 20% to price shown
 **** Add 16% to price shown

Belt Size	Grit	Price Per Belt
1" x 18"	100+	\$4.20
	80	\$4.09
	60	\$4.31
	50	\$4.39
	40	\$4.41
	36	\$4.51
	24	\$4.67
1" x 21"	100+	\$4.34
	80	\$4.39
	60	\$4.48
	50	\$4.54
	40	\$4.64
	36	\$4.71
	24	\$4.93
1" x 24"	100+	\$4.48
	80	\$4.51
	60	\$4.64
	50	\$4.76
	40	\$4.86
	36	\$4.93
	24	\$5.03
1" x 30"	100+	\$4.78
	80	\$4.84
	60	\$4.97
	50	\$5.10
	40	\$5.21
	36	\$5.35
	24	\$5.64
1-1/8" x 21"	100+	\$4.56
	80	\$4.64
	60	\$4.76
	50	\$4.86
	40	\$4.96
	36	\$5.10
	24	\$5.25
1" x 72"	100+	\$6.89
	80	\$7.00
	60	\$7.39
	50	\$7.73

Belt Size	Grit	Price Per Belt
1" x 72"	40	\$7.93
	36	\$8.28
	24	\$8.93
1" x 132"	100+	\$9.93
	80	\$10.17
	60	\$10.83
	50	\$11.31
	40	\$11.85
	36	\$12.48
	24	\$13.73
2" x 42"	100+	\$6.70
	80	\$7.49
	60	\$7.91
	50	\$8.23
	40	\$8.53
	36	\$8.92
	24	\$9.75
2" x 48"	100+	\$7.86
	80	\$8.21
	60	\$8.55
	50	\$8.86
	40	\$9.31
	36	\$9.71
	24	\$10.68
2" x 72"	100+	\$10.19
	80	\$10.63
	60	\$11.21
	50	\$11.73
	40	\$12.33
	36	\$13.00
	24	\$14.40
2" x 118"	100+	\$14.71
	80	\$15.29
	60	\$16.27
	50	\$17.16
	40	\$18.10
	36	\$19.14
	24	\$21.51

Belt Size	Grit	Price Per Belt
2" x 132"	100+	\$16.02
	80	\$16.70
	60	\$17.79
	50	\$18.26
	40	\$19.85
	36	\$21.04
	24	\$25.16
3" x 21"	100+	\$7.81
	80	\$7.99
	60	\$8.28
	50	\$8.53
	40	\$8.79
	36	\$9.17
	24	\$9.68
3" x 24"	100+	\$8.27
	80	\$8.42
	60	\$8.80
	50	\$9.00
	40	\$9.24
	36	\$9.66
	24	\$10.39
3" x 118"	100+	\$21.65
	80	\$22.60
	60	\$24.18
	50	\$25.46
	40	\$26.88
	36	\$28.55
	24	\$32.02
3" x 132"	100+	\$23.59
	80	\$24.70
	60	\$26.48
	50	\$27.80
	40	\$29.47
	36	\$31.37
	24	\$35.18
3-1/2" x 15-1/2"	100+	\$8.68
	80	\$8.85
	60	\$9.09

Belt Size	Grit	Price Per Belt	
3-1/2" x 15-1/2"	50	\$9.32	
	40	\$9.60	
	36	\$9.85	
	24	\$10.41	
4" x 21"	100+	\$10.39	
	80	\$10.64	
	60	\$10.99	
	50	\$11.31	
	40	\$11.69	
4" x 24"	100+	\$10.98	
	80	\$11.26	
	60	\$11.64	
	50	\$12.00	
	40	\$12.40	
4" x 24"	36	\$12.88	
	24	\$13.81	
	4" x 36"	100+	\$13.18
		80	\$13.68
		60	\$14.27
50		\$14.81	
40		\$15.34	
4" x 36"	36	\$16.07	
	24	\$17.44	
	4" x 54"	100+	\$16.60
		80	\$17.23
		60	\$18.10
50		\$18.95	
40		\$19.77	
4" x 54"	36	\$20.83	
	24	\$22.90	
	4" x 60"	100+	\$17.75
		80	\$18.45
		60	\$19.41
50		\$20.37	
40		\$21.29	
4" x 60"	36	\$22.45	
	24	\$24.73	

Belt Size	Grit	Price Per Belt
4" x 84"	100+	\$22.28
	80	\$23.28
	60	\$24.62
	50	\$25.92
	40	\$27.19
	36	\$28.85
	24	\$32.05
4" x 118"	100+	\$28.65
	80	\$30.08
	60	\$31.96
	50	\$33.86
	40	\$35.67
	36	\$37.90
24	\$42.36	
4" x 132"	100+	\$31.30
	80	\$32.92
	60	\$34.94
	50	\$37.06
	40	\$39.08
	36	\$41.65
24	\$46.69	

Belt Size	Grit	Price Per Belt
4" x 168"	100+	\$46.69
	80	\$38.08
	60	\$40.12
	50	\$42.79
	40	\$45.42
	36	\$48.00
24	\$51.26	
6" x 48"	100+	\$58.33
	80	\$23.17
	60	\$24.00
	50	\$25.17
	40	\$26.28
	36	\$27.40
24	\$28.77	
6" x 89"	100+	\$31.51
	80	\$34.71
	60	\$36.19
	50	\$38.40
	40	\$40.44
	36	\$42.62
24	\$45.07	

Belt Size	Grit	Price Per Belt
6" x 108"	100+	\$50.12
	80	\$40.03
	60	\$41.86
	50	\$44.54
	40	\$47.00
	36	\$49.66
	24	\$52.67
6" x 132"	100+	\$58.83
	80	\$46.77
	60	\$49.05
	50	\$52.26
	40	\$55.26
	36	\$57.06
24	\$60.68	
6" x 294"	100+	\$70.25
	80	\$92.33
	60	\$97.30
	50	\$104.52
	40	\$111.23
	36	\$118.44
24	\$126.65	

Belt Size	Grit	Price Per Belt
6" x 306"	100+	\$143.35
	80	\$95.72
	60	\$100.88
	50	\$108.37
	40	\$115.36
	36	\$122.88
24	\$131.37	
		\$148.90

PAPER BELTS

PS 20: Primarily for grinding and polishing on metals, but also useful on leather. Closed coat, Aluminum Oxide, resin-resin bonded to heavy F-weight paper. Best for wide belts and stroke sanders.

PS 21: F-weight paper, fully resin-bonded, alumina zirconia grains. Ideal on steel and stainless steel plates. Also for use on stamped parts, final grinding of cast-iron housings, and some woodworking applications

PS 22 ACT: For grinding and polishing metals and for finish sanding on hardwoods and leather. F-weight paper backing, Aluminum Oxide closed coat resin-resin bond available in intermediate and wide belts.

PS 24 ACT: Fully resin-bonded Silicon Carbide material, F-weight paper backing. Works well for non-ferrous metal applications, sanding between coats of paint, lacquer, varnish, etc. in woodworking applications, or for finish sanding of particle board or MDF. Available in wide belts, production belts, or stroke sanding belts.

PS 27W: Silicon Carbide, open coat steared on a D-weight backing for wide belts stroked sanding. Best suited for UV finishes or high gloss finishes in the woodworking industry.

PS 29 ACT: Aluminum Oxide open coat, resin-resin bond, F-weight paper material. Works well in any application where loading is a problem on soft woods or mix of hard and soft wood.

PS 61: Ceramic Aluminum Oxide, F weight paper backing. Ceramic grains on a durable paper backing create a perfect combination of longevity and economy. Excellent intermediate and finishing properties for steel and stainless steel.

Width	Grit	Price Per Belt
4" x 376"	100+	\$1.28
	80	\$1.38
6" x 274"	100+	\$1.44
	80	\$1.55
6" x 288"	100+	\$1.50
	80	\$1.62
6" x 298"	100+	\$1.54
	80	\$1.66
6" x 328"	100+	\$1.67
	80	\$1.80
6" x 330"	100+	\$1.68
	80	\$1.81
6" x 335"	100+	\$1.70
	80	\$1.83
6" x 376"	100+	\$1.87
	80	\$2.02
6" x 396"	100+	\$1.96
	80	\$2.11

- ** Add 10% to final price
- *** Add 20% to final price
- **** Add 40% to final price
- † Add 45% to final price

JOINT RECOMMENDATIONS FOR PAPER BELTS

GRIT	JOINT OPTIONS
80 - 120	#4
150+	#1, 4 YT



WATCH MORE
BELTS
IN ACTION



CLOTH BELTS

CS 308: Our YX weight Aluminum Oxide material is a fully resin-bonded product that offers the benefits of a polyester backing in an X-weight. Use on ferrous or non-ferrous metals and on hardwoods. CS 308 has an extended grit range that allows for coarse to ultra-fine belt sanding and polishing.

CS 310: Aluminum Oxide, X or X-Flex cloth resin-resin bond, closed coat. Suitable for all ferrous metals, hardwoods, leather, aluminum, stainless steel, and most alloys.

CS 311 YX ACT: Aluminum Oxide, anti-static, poly/cotton, resin bonded, open coat material for wood sanding operations where clogging or loading is a problem and sanding of soft woods or mix of hard and soft woods.

LS 313: ** Aluminum Oxide, semi-open coat, highly flexible J-flex backing, fully resin-bonded with a dry lubricant to reduce heat and clogging on stainless steel, aluminum, and titanium grinding and finishing.

CS 320: * Silicon Carbide on Y-weight polyester backings. Excellent for wet applications on glass, plastic, and stainless steels where strength of polyester would be a benefit.

CS 321: * Waterproof Silicon Carbide X-weight cloth resin bonded for grinding and polishing of glass, non-ferrous metals, plastics, stone, marble, grey cast iron, and titanium. Specially treated for use with water or water-based coolants.

CS 333: A versatile Silicon Carbide, fully resin bonded, X, J, or J-Flex cloth backings for

grinding and polishing of non-ferrous metals, grinding and polishing of plastic, glass, rubber, fiberglass, stone, marble, and grey cast iron.

CS 341: * Waterproof Aluminum Oxide fully resin bonded X-weight cloth for metal grinding and polishing where water or soluble oil coolants are used to reduce heat.

CS 412: * Aluminum Oxide, resin bonded, Y-weight (Y), and X-weight (YX), polyester-backings for use wet or dry on ferrous or non-ferrous metals. Also suitable for sanding hardwoods.

CS 538 ACT: **** Silicon Carbide, polyester backing and closed coat grain coverage make this a preferred product for the particle board and plywood industries. For wide belts only.

GX 533 JF: * Silicon Carbide grains resin-bonded to a new tough polyester/cotton blended backing with high flexibility and extra durability. Perfect on non-ferrous metals.

GX 712 JF: *** Aluminum oxide resin bonded to a new tough polyester/cotton blended backing with high flexibility and extra durability. A multibond lubricant is added for cooler grinding and better finishes on ferrous and non-ferrous metals.

* Add 5% to price shown
** Add 10% to price shown
*** Add 20% to price shown
**** Add 16% to price shown

Belt Size	Grit	Price Per Belt
25" x 48"	100+	\$75.50
	80	\$77.95
	60	\$81.85
	50	\$85.25
	40	\$89.05
	36	\$93.37
	24	\$102.14
25" x 60"	100+	\$86.18
	80	\$89.29
	60	\$94.14
	50	\$98.40
	40	\$103.14
	36	\$108.58
	24	\$119.50
25" x 75"	100+	\$99.55
	80	\$103.46
	60	\$109.48
	50	\$114.87
	40	\$120.74
	36	\$127.54
	24	\$141.22

Belt Size	Grit	Price Per Belt
30" x 103"	100+	\$148.91
	80	\$155.39
	60	\$165.35
	50	\$174.20
	40	\$183.77
	36	\$195.18
	24	\$217.47
36" x 60"	100+	\$123.44
	80	\$127.99
	60	\$134.94
	50	\$141.10
	40	\$147.93
	36	\$155.77
	24	\$171.48
36" x 75"	100+	\$142.56
	80	\$148.22
	60	\$156.91
	50	\$164.62
	40	\$173.16
	36	\$182.97
	24	\$202.59

Belt Size	Grit	Price Per Belt
37" x 60"	100+	\$130.29
	80	\$135.06
	60	\$142.44
	50	\$148.97
	40	\$156.11
	36	\$164.43
	24	\$180.98
37" x 75"	100+	\$150.42
	80	\$156.44
	60	\$165.61
	50	\$173.77
	40	\$182.70
	36	\$193.12
	24	\$213.83
43" x 75"	100+	\$173.93
	80	\$180.79
	60	\$191.43
	50	\$200.89
	40	\$211.11
	36	\$223.37
	24	\$247.30

Belt Size	Grit	Price Per Belt
50" x 103"	100+	\$246.73
	80	\$257.59
	60	\$274.15
	50	\$288.93
	40	\$305.15
	36	\$323.86
	24	\$361.29
52" x 75"	100+	\$213.12
	80	\$221.64
	60	\$234.66
	50	\$246.31
	40	\$259.05
	36	\$273.76
	24	\$303.21
52" x 103"	100+	\$266.39
	80	\$278.03
	60	\$295.91
	50	\$311.96
	40	\$329.37
	36	\$349.62
	24	\$389.98



KLINGSPOR
BELT
JOINTS



PAPER BELTS

PS 20: Primarily for grinding and polishing on metals, but also useful on leather. Closed coat, Aluminum Oxide, resin-resin bonded to heavy F-weight paper. Best for wide belts and stroke sanders.

PS 21: F-weight paper, fully resin-bonded, alumina zirconia grains. Ideal on steel and stainless steel plates. Also for use on stamped parts, final grinding of cast-iron housings, and some woodworking applications

PS 22 ACT: For grinding and polishing metals and for finish sanding on hardwoods and leather. F-weight paper backing, Aluminum Oxide closed coat resin-resin bond available in intermediate and wide belts.

PS 24 ACT: Fully resin-bonded Silicon Carbide material, F-weight paper backing. Works well for non-ferrous metal applications, sanding between coats of paint, lacquer, varnish, etc. in woodworking applications, or for finish sanding

of particle board or MDF. Available in wide belts, production belts, or stroke sanding belts.

PS 27W: Silicon Carbide, open coat stearated on a D-weight backing for wide belts stroked sanding. Best suited for UV finishes or high gloss finishes in the woodworking industry.

PS 29 ACT: Aluminum Oxide open coat, resin-resin bond, F-weight

paper material. Works well in any application where loading is a problem on soft woods or mix of hard and soft wood.

PS 61: Ceramic Aluminum Oxide, F weight paper backing. Ceramic grains on a durable paper backing create a perfect combination of longevity and economy. Excellent intermediate and finishing properties for steel and stainless steel.

** Add 10% to final price
 *** Add 20% to final price
 **** Add 40% to final price
 † Add 50% to final price

Width	Grit	Price Per Belt	Width	Grit	Price Per Belt
19" x 48"	100+	\$54.06	37" x 60"	100+	\$95.03
	80	\$56.15		80	\$99.42
24" x 55"	100+	\$70.27	37" x 75"	100+	\$105.41
	80	\$73.24		80	\$110.87
24" x 60"	100+	\$73.04	43" x 75"	100+	\$121.92
	80	\$65.05		80	\$128.08
24" x 84"	100+	\$86.30	50" x 103"	100+	\$163.47
	80	\$68.99		80	\$173.14
25" x 48"	100+	\$67.22	52" x 75"	100+	\$149.12
	80	\$60.51		80	\$156.76
25" x 60"	100+	\$63.86	52" x 103"	100+	\$176.40
	80	\$66.78		80	\$186.76
25" x 75"	100+	\$82.36	62" x 103"	100+	\$202.08
	80	\$86.62		80	\$214.03
30" x 103"	100+	\$96.54	64" x 103"	100+	\$208.44
	80	\$102.38		80	\$220.91
36" x 60"	100+	\$88.72			
	80	\$92.75			
36" x 75"	100+	\$98.18			
	80	\$103.29			



KLINGSPOR
WIDE
 BELTS

ALUMINUM OXIDE FLEXIBLE-BACKED MATERIAL

Standard Size dia. x width*	Standard Belt Size width x length	Grit	Price Per Sleeve
2" x 9"	9" x 7-15/32"	100+	\$4.16
		80	\$4.39
3" x 9"	9" x 10-5/8"	100+	\$5.90
		80	\$6.22
4" x 9"	9" x 13-3/4"	100+	\$7.67
		80	\$8.04
6" x 9"	9" x 20"	100+	\$10.28
		80	\$10.87
8" x 9"	9" x 26-5/16"	100+	\$14.61
		80	\$15.40
2" x 8"	8" x 7-15/32"	100+	\$3.82
		80	\$4.06
3" x 8"	8" x 10-5/8"	100+	\$5.30
		80	\$5.55
4" x 8"	8" x 13-3/4"	100+	\$6.71
		80	\$7.05
6" x 8"	8" x 20"	100+	\$8.84
		80	\$9.34
8" x 8"	8" x 26-5/16"	100+	\$11.97
		80	\$12.62
12" x 7"	7" x 7-15/32"	100+	\$3.82
		80	\$4.05
3" x 7"	7" x 10-5/8"	100+	\$5.30
		80	\$5.57
4" x 7"	7" x 13-3/4"	100+	\$6.71
		80	\$6.69
6" x 7"	7" x 20"	100+	\$8.84
		80	\$9.34
8" x 7"	7" x 26-5/16"	100+	\$11.99
		80	\$12.62

- Any pump sleeves under 10" in length will have a straight joint.
- Consider LS 318 as an open coat option for pump sleeves.

PUMP DRUMS

Size	Item Number	Net Price
2" x 7" x 1"	PUMPDRUM2X7X25	\$318.49
2" x 9" x 3/4"	PUMPDRUM2X9X20	\$190.08
2" x 9" x 1"	PUMPDRUM2X9X25	\$190.08
3" x 9" x 1-1/4"	PUMPDRUM3X9X32	\$235.79
4" x 7" x 1-1/4"	PUMPDRUM4X7X32	\$235.79
4" x 9" x 1-1/4"	PUMPDRUM4X9X32	\$235.79
6" x 7" x 1-1/4"	PUMPDRUM6X7X32	\$293.30
6" x 9" x 1-1/4"	PUMPDRUM6X9X32	\$307.96
8" x 9" x 1-1/4"	PUMPDRUM8X9X32	\$433.08

Pump Drum Repair Kit - Kit includes screws, 1 tube of rubber adhesive, 1 roll of tape and 6 valves
 #PUMPDRUMREPAIRKIT\$82.30

Pump Drum Valve Stem
 #PUMPDRUMVALVESTEM\$18.92

PUMP DRUM BLADDERS

Size	Item Number	Net Price
2" x 9"	PUMPDRUMBLAD2X9	\$34.88
3" x 9"	PUMPDRUMBLAD3X9	\$42.10
4" x 9"	PUMPDRUMBLAD4X9	\$42.10
6" X 7"	PUMPDRUMBLAD6X7	\$60.15
6" X 9"	PUMPDRUMBLAD6X9	\$69.78
8" X 9"	PUMPDRUMBLAD8X9	\$84.21

ARBOR ADAPTERS

Size	Item Number	Pair Price
1-1/4" - 1"	PUMPDRUMADAPT01	\$17.28
1-1/4" - 3/4"	PUMPDRUMADAPT02	\$17.28
1" - 3/4"	PUMPDRUMADAPT03	\$17.28
1-1/4" - 5/8"	PUMPDRUMADAPT04	\$17.28



DYNABRADE PNEUMATIC DRUM SLEEVES

Drum Size Dia x Width	Belt Size Width x Length
2-1/4" x 3"	3" x 7-3/8"
3" x 2-1/4"	2-1/4" x 9-3/4"
3-1/4" x 3"	3" x 10-11/16"
90mm x 100mm	4" x 11-3/8"
5" x 2-3/4"	2-3/4" x 15-1/2"
5" x 3-1/2"	3 1/2" x 15-1/2"

All Pneumatic Sleeves Have #4 Butt Joint

WALTER PNEUMATIC DRUM SLEEVES

Drum Size Dia x Width	Belt Size Width x Length
5" x 3-1/2"	3-1/2" x 15-1/2"
3-1/2" x 5-3/8"	5-3/8" x 11-5/8"

UNITEC DRUM SLEEVES

Drum Size Dia x Width	Belt Size Width x Length
3-1/2" x 4"	4" x 11"

METABO DRUM SLEEVES

Drum Size Dia x Width	Belt Size Width x Length
3-9/16" x 4"	4" x 11-1/4" (pneumatic)
3-9/16" x 4"	4" x 11-1/8" (expander)

* J or JF belts not recommended on pneumatic & expander drums

CS 310: Aluminum Oxide, X or X-Flex cloth resin-in-resin bond, closed coat. Suitable for all ferrous metals, hardwoods, leather, aluminum, stainless steel, and most alloys.

CS 320: Silicon Carbide on Y-weight polyester backings. Excellent for wet applications on glass, plastic, and stainless steels where strength of polyester would be a benefit.

CS 321: Waterproof Silicon Carbide X-weight cloth resin bonded for grinding and polishing of glass, non-ferrous metals, plastics, stone, marble, grey cast iron, and titanium. Specially treated for use with water or water-based coolants.

CS 333: A versatile Silicon Carbide, fully resin bonded, X, J, or J-Flex cloth backings for grinding and polishing of non-ferrous metals, grinding and polishing of plastic, glass, rubber, fiberglass, stone, marble, and grey cast iron.

CS 409: Alumina Zirconia grain with a multi-bond additive on polyester backing for grinding high alloys such as titanium and metals like stainless steel where heat build-up is a problem.

CS 411 X; CS 411YX, Y: Alumina Zirconia resin-bonded, with backings available in both X-weight cloth (YX) or polyester cloth in Y-weight (Y) for high pressure, heavy stock removal on all types of metal, especially carbon and tool steels. Polyester backings can be used wet or dry.

CS 412: Aluminum Oxide, resin bonded, Y-weight (Y), and X-weight (YX), polyester-backings for use wet or dry on ferrous or non-ferrous metals. Also suitable for sanding hardwoods.

CS 416: 100% Alumina Zirconia semi-open coat on a heavy or extra heavy polyester backing for high pressure production situations grinding steel, stainless steel, non-ferrous metals, plastic, leather and wood planing.

CS 920 ACT: Ceramic Aluminum Oxide with multi-bond lubricant added to enhance the grinding properties and cool the grinding surface. Features a heavy polyester backing that enhances its durability while removing large amounts of stock.

CS 922 ACT: Ceramic Aluminum Oxide on our heaviest YY polyester backing for use on steels of all types and under high grinding pressure applications.

NWLS: This stiff scrim back nonwoven offers exceptional life while maintaining great cutting performance and a consistent scratch. NWLS is best suited for polishing, cleaning, and deburring stainless steels, steels, aluminum, and other non ferrous metals.

Check with KLINGSPOR Customer Relations for prices based on material type



KLINGSPOR
PUMP
SLEEVES

**PS 33 ALUMINUM OXIDE
STEARATE • B/C WEIGHT PAPER**



Aluminum Oxide B or C-weight paper, resin-resin bond for bare wood sanding, autobody use, sanding of bare metal, primer, primer surfacer, between coats of paint, and sanding of solid surface materials.

Size	Grit	Price Per Pack	
9" x 11" 50/Pack	600B-150B	\$77.21	
	120C-100C	\$77.21	
	80	\$84.92	
	60	\$96.50	
	40	\$120.94	
	4-1/2" x 11" 100/Pack	600B-150B	\$87.50
		120C-100C	\$87.50
80		\$97.79	
60		\$110.64	
	40	\$138.96	
	3-2/3" x 9" 100/Pack	600B-150B	\$59.22
		120C-100C	\$59.22
80		\$66.90	
60		\$74.60	
	40	\$94.85	
	4-1/2" x 5-1/2" 100/Pack	600B-150B	\$43.77
		120C-100C	\$43.77
80		\$46.34	
60		\$56.61	
	40	\$69.51	

**PS 11 SILICON CARBIDE
WATERPROOF • A/C WEIGHT
LATEX PAPER**



Waterproof Silicon Carbide, A and C-weight papers, resin-resin bonded and available in grits P60 - P2000. Use for sanding of furniture finishes such as varnish, lacquer, shellac, oil, polishing of glass, and in automotive body shops for final color sanding of paint.

Size	Grit	Price Per Pack
9" x 11" 50/Pack	2000A-220A	\$76.35
	180C	\$82.68
	150C	\$87.76
	120C	\$92.87
	100C	\$106.84
	80C	\$122.11
3-2/3" x 9" 100/Pack	2000A-220A	\$58.55
	180C	\$63.61
	150C	\$68.71
	120C	\$71.19
	100C	\$81.40
	80C	\$94.15
	4-1/2" x 5-1/2" 100/Pack	2000A-220A
180C		\$45.81
150C		\$48.33
120C		\$53.41
	100C	\$63.61
	80C	\$71.19

**VP 73W ALUMINUM OXIDE
STEARATE LATEX PAPER**



Enhanced 73W material with a latex impregnated backing for longer edgewear and life. May be used on bare wood, composite, marine and autobody. This material is not waterproof.

Size	Grit	Price Per Pack
9" x 11" 50/Pack	100+	\$88.77
	80	\$97.67
4-1/2" x 11" 100/Pack	100+	\$100.58
	80	\$112.44
3-2/3" x 9" 100/Pack	100+	\$71.00
	80	\$76.91
4-1/2" x 5-1/2" 100/Pack	100+	\$50.32
		\$53.29

**KL 371 EMERY CLOTH •
HEAVY COTTON CLOTH**



Grits P40 - P320 contain emery grain, a natural form of Aluminum Oxide, glue-glue bond, medium weight cloth similar to X-weight for general purpose grinding and polishing of metals. The lightweight cloth backing is similar to J-weight.

Size	Grit	Price Per Pack
9" x 11" 50/Pack	320-80	\$123.51
	60-50	\$140.25
	40	\$162.13

**PS 10 GARNET •
A/C/D WEIGHT PAPER**



Premium Garnet material used in hand, fine finish type sanding, or sanding undercoats of finishing materials. Offers a "softer" cut that leaves a smoother surface. Sheets only.

Size	Grit	Price Per Pack
9" x 11"	220	\$41.16
50/Pack	180	\$41.16
	150	\$41.16
	120	\$41.16
	100	\$41.16
	80	\$48.90

**KL 361 "PREMIUM" ALUMINUM
OXIDE CLOTH FLEXIBLE
COTTON CLOTH**



Aluminum Oxide J-flex cloth backing, resin-resin bonded for general purpose use on all metals or wood. Shop roll material.

Size	Grit	Price Per Pack
9" x 11"	100+	\$155.70
	80	\$166.00
	60	\$200.69
	40	\$232.86
4-1/2" x 11"	100+	\$180.15
	80	\$193.00
	60	\$231.67
3-2/3" x 9"	100+	\$118.30
	80	\$126.09
	60	\$154.40
4-1/2" x 5-1/2"	100+	\$90.06
	80	\$95.24
	60	\$115.80
	40	N/A

**FP 77 ALUMINUM OXIDE
FILM WITH TACT**



Aluminum Oxide on a 3 mil poly film in grits 60-2000. KLINGSPOR's proprietary coating technology makes this product the perfect choice when loading is an issue. Available in discs, sheets and rolls. FP 77 is waterproof.

Size	Grit	Price Per Pack
9" x 11"	80 - 2000	\$115.34
50/Pack		

**PS 36 ALUMINA ZIRCONIA
STEARATE • C/D WEIGHT PAPER**



This C or D weight paper product from KLINGSPOR combines the effectiveness of Alumina Zirconia grains and a stearate coating with the leveling properties of paper. Excellent results can be achieved when sanding wood, metal, and various other substances including body fillers. PS 36 is a premium fully resin bonded product.

Size	Grit	Price Per Pack
9" x 11" 50/Pack	100C+	\$93.21
50/Pack	80C	\$102.52
	60C	\$116.50
50/Pack	40D	\$145.97
25/Pack	36D	\$86.79
4-1/2" x 11" 100/Pack	100C+	\$105.62
100/Pack	80C	\$118.07
100/Pack	60C	\$133.58
100/Pack	40D	N/A
50/Pack	36D	\$99.74
3-2/3" x 9" 100/Pack	100C+	\$71.49
100/Pack	80C	\$80.75
100/Pack	60C	\$90.06
100/Pack	40D	\$111.82
50/Pack	36D	\$66.50
4-1/2" x 5-1/2" 100/Pack	100C+	\$52.81
100/Pack	80C	\$55.90
100/Pack	60C	\$68.32
100/Pack	40D	\$83.85
100/Pack	36D	\$99.67



PS 35 LIGHTWEIGHT SILICON CARBIDE STEARATE • W WEIGHT PAPER



B-weight Silicon Carbide paper, resin bonded, open coat top-coated with Zinc Stearate dry lubricant. Suitable for sanding contoured surfaces or flat surfaces by hand, with sanding blocks, or on vibrating sanders. Ideal for sanding primer, paint, bare metal, and rust, or in woodworking, for sanding sealer, wash coats, bare softwoods and hardwoods, and between coats of furniture finishes.

Size	Grit	Price Per Pack
9" x 11"	120+	\$47.25
50/Pack	80	\$59.48
4-1/2" x 11"	120+	\$62.07
100/Pack	80	N/A
3-2/3" x 9"	120+	\$38.79
100/Pack	80	N/A
4-1/2" x 5-1/2"	120+	\$31.03
100/Pack	80	\$33.67

PL 31 OPEN COAT ALUMINUM OXIDE B WEIGHT PAPER



Aluminum Oxide open coat B weight paper material. Produces a soft consistent finish at a budget price.

Size	Grit	Price Per Pack
9" x 11"	100+	\$39.05
50/Pack	80B	\$43.60
	60B	\$48.25
	40B	\$68.29

PSA SHEETS FOR POWER SHEET SANDERS - PS33



Aluminum Oxide B or C-weight paper, resin-resin bond for bare wood sanding, autobody use, sanding of bare metal, primer, primer surfacer, between coats of paint, and sanding of solid surface materials.

Size	Grit	Price Per Pack
4-1/2" x 4-1/2"	100+	\$41.79
100/Roll	80	\$49.15
3-2/3" x 7"	100+	\$53.32
100/Roll	80	\$60.32
2-3/4" x 8"	100+	\$46.70
100/Roll	80	\$54.08
3" x 4-3/8"	100+	\$34.72
100/Roll	80	N/A



Make short work of body filler or metal with these popular-sized file board sheets.

PLAIN SHEETS
2-3/4" X 17-1/2"

Material	Grit	Box Qty	Price Per Box
PS 33	100+	100	\$67.57
	80	50	\$37.83
	60	50	\$46.26
	40	50	\$51.23
PS 29	80	50	\$60.56
	60	50	\$68.80
	40	50	\$82.48
PS 21	100+	50	\$67.55
	80	50	\$72.07
	40	50	\$97.52
PS 36	100+	50	\$46.97
	80	50	\$51.95
	60	50	\$64.38
	40	50	\$71.36
	36	25	\$37.94

PSA SHEETS
2-3/4" X 16-1/2"

Material	Grit	Box Qty	Price Per Box
PS 33	100+	50	\$52.52
	80	50	\$57.51
	60	50	\$65.05
	40	50	\$71.29
PS 29	80	50	\$78.78
	60	50	\$86.28
	40	50	\$92.53
PS 21	100+	50	\$90.02
	80	50	\$93.77
	60	50	\$103.78
	40	50	\$112.52
PS 36	100+	50	\$73.08
	80	50	\$80.07
	60	50	\$90.49
	40	50	\$99.20

KLING-ON® SHEETS
2-3/4" X 16-1/2"

Material	Grit	Box Qty	Price Per Box
PS 33	100+	50	\$75.91
	80	50	\$82.37
	60	50	\$83.61
	40	50	\$86.22
PS 29	80	25	\$58.42
	60	25	\$62.37
	40	25	\$62.40

PS 20: Primarily for grinding and polishing on metals. Closed coat, Aluminum Oxide, resin-resin bonded to heavy F-weight paper. Best for wide belts and stroke sanders.

PS 21: F-weight paper, fully resin-bonded, alumina zirconia grains. Ideal on steel and stainless steel plates. Also for use on stamped parts, final grinding of cast-iron housings, and some woodworking applications.

PS 29 ACT: Aluminum Oxide open coat, resin-resin bond, F-weight paper material. Works well in any application where loading is a problem on soft woods or mix of hard and soft wood.

PS 33: Aluminum Oxide B or C-weight paper, resin-resin bond for autobody use, sanding of bare metal, primer, primer surfacer, between coats of paint, and sanding of solid surface materials. **Semi-Open Coat**

PS 36: This C or D weight paper product from KLINGSPOR combines the effectiveness of Alumina Zirconia grains and a stearate coating with the leveling properties of paper. Excellent results can be achieved when sanding metal, and various other substances including body fillers. PS 36 is a premium fully resin bonded product. **Semi-Open Coat**



SANDING BOARD

2.75" X 15"
Hook & Loop
FJ27515H.....\$93.25

2.75" X 15"
PSA
FJ27515V.....\$93.25

25 meter (27 yard) rolls available at 75% off prices shown • 50 meter (54-1/2 yard) rolls available at 50% off prices shown
 Shorter lengths in 10 meter increments available with a 15% up charge

CLOTH ROLLS 100 METERS - 109 YARD

CS 308: Our YX weight Aluminum Oxide material is a fully resin-bonded product that offers the benefits of a polyester backing in an X-weight. Use on ferrous or non-ferrous metals and on hardwoods. CS 308 has an extended grit range that allows for coarse to ultra-fine belt sanding and polishing.

LS 309: Aluminum Oxide, fully resin bonded, J or J-flex cotton cloth for polishing ferrous or non-ferrous metals and hardwoods where belt conformability to the work piece is required. Narrow belts and some intermediate belts. XH backing is for portable belts only.

CS 310: Aluminum Oxide, X cloth resin-resin bond, closed coat. Suitable for all ferrous metals, hardwoods, leather, aluminum, stainless steel, and most alloys.

CS 311 YX ACT: Aluminum Oxide, anti-static, poly/cotton, resin bonded, open coat material for wood sanding operations where clogging or loading is a problem and sanding of soft woods or mix of hard and soft woods.

LS 312: Aluminum Oxide, semi-open coat resin bonded with a special top coating to aid in cooling and to resist loading. Very flexible, J-Flex cloth backing for severely contoured workpieces. Best suited for polishing stainless steel and high alloy steels, other ferrous metals and non-ferrous metals.

LS 313: Aluminum Oxide, semi-open coat, highly flexible J-flex backing, fully resin-bonded with a dry lubricant to reduce heat and clogging on stainless steel, aluminum, and titanium grinding and finishing.

CS 320: Silicon Carbide on Y-weight polyester backings. Excellent for wet applications on glass, plastic, and stainless steels where strength of polyester would be a benefit.

CS 321: Waterproof Silicon Carbide X-weight cloth resin bonded for grinding and polishing of glass, non-ferrous metals, plastics, stone, marble, grey cast iron, and titanium. Specially treated for use with water or water-based coolants.

CS 333: A versatile Silicon Carbide, fully resin bonded, J, or J-Flex cloth backings for grinding and polishing of non-ferrous metals, grinding and polishing of plastic, glass, rubber, fiber-glass, stone, marble, and grey cast iron.

CS 341: Waterproof Aluminum Oxide fully resin bonded X-weight cloth for metal grinding and polishing where water or soluble oil coolants are used to reduce heat.

CS 411 X*, Y****:** Alumina Zirconia resin-bonded, with backings available in both X-weight cloth (YX) or polyester cloth in Y-weight (Y) for high pressure, heavy stock removal on all types of metal, especially carbon and tool steels. Polyester backings can be used wet or dry.

CS 412: Aluminum Oxide, resin bonded, Y-weight (Y), and X-weight (YX), polyester-backings for use wet or dry on ferrous or non-ferrous metals. Also suitable for sanding hardwoods.

CS 710: Heat-treated Aluminum Oxide, X-Flex cloth resin-resin bond, closed coat. Suitable for polishing all ferrous metals and sanding on hardwoods.

- * Add 5% to final price ** Add 10% to final price
- *** 24-36 Grit - Add 40.32% to price shown
 40-60 Grit - Add 33.10% to price shown
 80 Grit - Add 27.56% to price shown
 120 Grit - Add 27.56% to price shown
- **** 24-36 Grit - Add 57.15% to price shown
 40-60 Grit - Add 49.71% to price shown
 80 Grit - Add 46.05% to price shown
 120 Grit - Add 31.14% to price shown

Width	Grit	Price Per Roll
1"	100+	\$144.33
	80	\$150.34
	60	\$164.92
	50	\$174.02
	40	\$185.53
2"	36	\$200.05
	100+	\$277.11
	80	\$291.61
	60	\$315.27
	50	\$335.90
3"	40	\$359.56
	36	\$386.24
	100+	\$406.82
	80	\$430.49
	60	\$468.69
4"	50	\$484.33
	40	\$533.53
	36	\$574.79
	100+	\$539.02
	80	\$571.74
5"	60	\$618.43
	50	\$663.30
	40	\$706.99
	36	\$763.36
	100+	\$671.82
6"	80	\$709.00
	60	\$771.81
	50	\$793.18
	40	\$825.19
	36	\$883.98
6"	100+	\$804.59
	80	\$851.86
	60	\$922.21
	50	\$987.07
	40	\$1,058.03
	36	\$1,137.43

PAPER ROLLS 100 METERS - 109 YARD

PS 20: Primarily for grinding and polishing on metals, but also useful on leather. Closed coat, Aluminum Oxide, resin-resin bonded to heavy F-weight paper. Best for wide belts and stroke sanders.

PS 21: F-weight paper, fully resin-bonded, alumina zirconia grains. Ideal on steel and stainless steel plates. Also for use on stamped parts, final grinding of cast-iron housings, and some woodworking applications * Add 20% to price shown

PS 22 ACT: For grinding and polishing metals and for finish sanding on hardwoods and leather. F-weight paper backing, Aluminum Oxide closed coat resin-resin bond available in intermediate and wide belts.

PS 24 ACT: Fully resin-bonded Silicon Carbide material, F-weight paper backing. Works well for non-ferrous metal applications, sanding between coats of paint, lacquer, varnish, etc. in woodworking applications, or for finish sanding of particle board or MDF. Available in wide belts, production belts, or stroke sanding belts. * Add 10% to price shown

PS 29 ACT: Aluminum Oxide open coat, resin-resin bond, F-weight paper material. Works well in any application where loading is a problem on soft woods or mix of hard and soft wood.

Width	Grit	Price Per Roll
2"	100+	\$145.04
	80	\$159.29
	60	\$179.93
	50	\$204.08
	40	\$224.48
3"	100+	\$211.20
	80	\$230.68
	60	\$262.43
	50	\$297.25
	40	\$334.95
4"	100+	\$276.63
	80	\$304.37
	60	\$345.61
	50	\$390.44
	40	\$442.33
4-1/2"	100+	\$309.36
	80	\$338.86
	60	\$387.22
	50	\$438.80
	40	\$494.24
5"	100+	\$342.07
	80	\$373.35
	60	\$428.79
	50	\$487.12
	40	\$546.18
6"	100+	\$408.25
	80	\$445.85
	60	\$511.31
	50	\$580.98
	40	\$653.55



KLING-ON® ROLLS

PS 33

Size	Grit	Price Per Roll
2-3/4" x 10MT	40	\$33.02
	80	\$30.68
	100+	\$26.22
3-2/3" x 10MT	40	\$45.33
	80	\$42.26
	100+	\$41.92

VP 73W

Size	Grit	Price Per Roll
3-2/3" x 10MT	100+	\$39.07
4-1/2" x 10MT	100+	\$41.12

PS 29 For Drum Sanding

Size	Grit	Price Per Roll
6" x 10MT	40	\$109.12
	60	\$94.06
	80	\$74.44
	100+	\$68.16

PS 36

Size	Grit	Price Per Roll
2-3/4" x 10MT	40	\$40.58
	80	\$37.54
3-2/3" x 10MT	100+	\$42.97
4-1/2" x 10MT	80	\$56.33
	100+	\$48.32

FP 77

Size	Grit	Price Per Roll
2-3/4" x 10MT	80-2000	\$37.03

10MT = APPROX 33 FEET



PS 33: Aluminum Oxide B or C-weight paper, resin-resin bond for bare wood sanding, autobody use, sanding of bare metal, primer, primer surfacer, between coats of paint, and sanding of solid surface materials. [Semi-Open Coat](#)

VP 73W: Enhanced 73W material with a latex impregnated backing for longer edgewear and life. May be used anywhere the regular PS33 is found including bare wood, composite, marine and autobody. This material is not waterproof. [Semi-Open Coat](#)

PS 29 ACT: Aluminum Oxide open coat, resin-resin bond, F-weight paper material. Works well in any application where loading is a problem on soft woods or mix of hard and soft wood. [Open Coat](#)

PS 36: This C or D weight paper product from KLINGSPOR combines the effectiveness of Alumina Zirconia grains and a stearate coating with the leveling properties of paper. Excellent results can be achieved when sanding wood, metal, and various other substances including body fillers. PS 36 is a premium fully resin bonded product. [Semi-Open Coat](#)

FP 77: Aluminum Oxide on a C weight paper backing in grits 60-220, and on a 3 mil poly film (FP 77) in grits 320-2000. KLINGSPOR's proprietary coating technology makes this product the perfect choice when loading is an issue. Available in discs, sheets and rolls. FP 77 is waterproof. [Semi-Open Coat](#)



PSA ROLLS WITH LINER

PS 33

Size	Grit	Price Per Roll
2-3/4" x 10MT	40	\$23.96
	80	\$23.96
	100+	\$21.48
4-1/2" x 10MT	40	\$39.42
	80	\$31.57
	100+	\$29.22

PS 29

Size	Grit	Price Per Roll
2-3/4" x 10MT	40	\$43.86
	60	\$38.32
	80	\$40.07
	100+	\$35.78
4-1/2" x 10MT	40	\$71.81
	60	\$65.80
	80	\$57.34
	100+	\$44.95

PS 36

Size	Grit	Price Per Roll
2-3/4" x 10MT	40	\$34.49
	60	\$25.82
	80	\$22.26
4-1/2" x 10MT	100+	\$21.99
	40	\$50.24
	80	\$36.99
	100+	\$35.90

10MT = APPROX 33 FEET



**PREMIUM SHOP ROLLS
- 50 YARD**

Not for use on drum sanders.

**KL 361 ALUMINUM OXIDE
FLEXIBLE COTTON CLOTH**

Aluminum Oxide J-flex cloth backing, resin-resin bonded for general purpose use on all metals or wood. Shop roll material.

Width	Grit	Price Per Roll
1"	100+	\$59.83
	80	\$62.69
	60	\$73.21
	50	\$78.71
	40	\$84.18
1-1/2"	100+	\$84.51
	80	\$86.95
	60	\$104.24
	50	\$110.51
	40	\$117.30
2"	100+	\$106.99
	80	\$112.34
	60	\$134.43
	50	\$150.32
	40	\$156.33
3"	100+	\$157.59
	80	\$165.89
	60	\$179.12
	50	\$192.39
	40	\$207.30
4"	100+	\$210.08
	80	\$221.15
	60	\$238.86
	50	\$256.50
	40	\$276.43
6"	100+	\$315.54
	80	\$332.13
	60	\$358.72
	50	\$385.28
	40	\$415.20



SCAN TO WATCH

KL 361

IN ACTION

How to Choose **SMT TITAN**

LIFE

SMT 950 T-XL TITAN

- Alumina Zirconia Grain
- 20% more flaps for our thickest disc!
- Offered in angled or flat for diverse applications.
- Our Longest Lasting Flap Disc
- High Level of aggression
- Best suited for use on high powered grinders

FINISHING

SMT 850 T TITAN

- Best results are achieved with a variable speed grinder
 - Combination of coated and non-woven abrasives
 - Coated abrasive with multibond lubricant allows for cooler finishing on stainless
 - Produces a beautiful satin finish

SMT 800 T TITAN

- Full non-woven abrasive flap disc
- Perfect for satin finishes on stainless
- Best results are achieved with a variable speed grinder

SMT 975 T TITAN

- Newly developed ceramic grain
- High level of aggression for faster cutting and high removal rates
- Best suited for use on high-powered grinders

SMT 975 T TITAN

- Newly developed ceramic grain
- High level of aggression for faster cutting and high removal rates
- Best suited for use on high-powered grinders

SMT 624 T TITAN

- Alumina Zirconia
- High level of aggression
- Well suited for use on high-powered grinders
- Angled for effective grinding of welds, contoured surfaces, and edges

SMT 636 T TITAN

- Runs cooler for grinding on stainless steel
 - Alumina Zirconia treated with multibond lubricant
- Reduced clogging and loading associated with heat build-up
 - Newly developed ceramic grain
- High level of aggression for faster cutting & high removal rates
 - Best suited for use on high-powered grinders

SMT 924 T TITAN

- Most aggressive Titan
- High level of aggression for faster cutting and high removal rates
- Best suited for use on high-powered grinders

AGGRESSION

STAINLESS STEEL

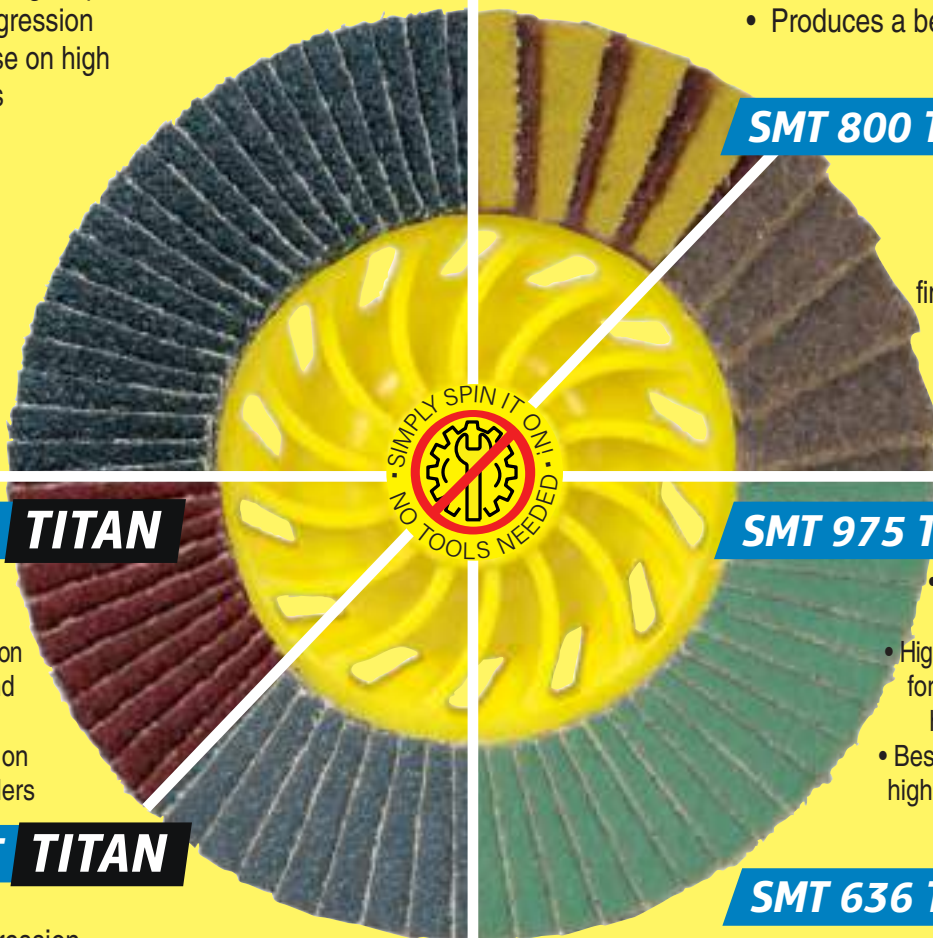

SMT TITAN

ADVANTAGES

- **LONGEVITY:** Largest advantage is the longevity of the discs compared to a standard SMT. The unique design of the trimmable discs allows the user to utilize the entirety of the flaps, giving much longer life. The hard to reach middle section of the flaps often go unused, and with the trimmable backing, the user simply has to trim the edge back and easily access the untouched new abrasive. Longer use of each disc in return means that production time is saved by less frequent disc changes.

- **QUICK CHANGE:** Easy and quick disc change. The discs include a built in 5/8"-11 threaded arbor for quick and easy mounting.
- **COOL RUN:** The ability to run cooler. The unique fan shape of the backing allows the disc to run cooler, giving the disc more life.
- Firm plastic backing plate allows for more aggression when needed.

ITEMS & AVAILABILITY

- 4-1/2" angled and flat versions
- Several of our well-working options receive a trimmable backing: the SMT 624 Convex, SMT 624 Flat, SMT800, SMT 850, SMT 636, SMT 996

MARKETS

- Fab shops
- Production shops
- Oil & Gas
- Autobody/ Restoration shops
- Stainless shops and welding shops



SMT 624 T TITAN

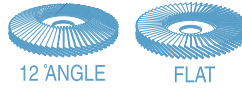

SPECIFICATIONS

- Alumina Zirconia
- High level of aggression
- Angled for effective grinding of welds, contoured surfaces, and edges
- Well suited for use on high-powered grinders

APPLICATIONS

- Weld seam work
- Edge work/beveling
- Universal metal & steel
- Stainless steel/High alloy stainless steel

Diameter	Bore Size	Grit	Availability	Price Per Each
4-1/2"	5/8"-11	120	Flat	\$10.88
10/Box	5/8"-11	80	Convex or Flat	\$10.88
	5/8"-11	60	Convex or Flat	\$10.88
	5/8"-11	40	Convex or Flat	\$10.88
	5/8"-11	36	Convex	\$10.88

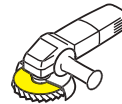

MAXIMUM RPM'S: 13,300

SMT 924 T TITAN

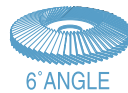

SPECIFICATIONS

- Most aggressive Titan
- High level of aggression for faster cutting and high removal rates
- Best suited for use on high-powered grinders

APPLICATIONS

- Weld seam grinding
- Edge grinding and beveling
- Universal for metals and steels

Diameter	Bore Size	Grit	Availability	Price Per Each
4-1/2"	5/8"-11"	36	Convex	\$12.82
10/Box				

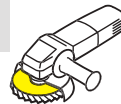

MAXIMUM RPM'S: 5,500

SMT 636 T TITAN

MAX RPM'S: 13,300



SPECIFICATIONS

- Alumina Zirconia treated with multibond lubricant
- Runs cooler for grinding on stainless steel
- Reduced clogging and loading associated with heat build-up

APPLICATIONS

- Weld seam work
- Edge work/beveling
- Universal metal & steel
- Stainless steel/High alloy stainless steel
- Aluminum & non-ferrous metals

Diameter	Bore Size	Grit	Price Per Each
4-1/2"	5/8"-11	80	\$12.44
10/Box	5/8"-11	60	\$12.44
	5/8"-11	40	\$12.44

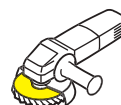

REDUCED CLOGGING AND LOADING WHEN GRINDING ALUMINUM

STABLE GRINDING
TEMPERATURES
FOR BETTER
SURFACE FINISHES



SMT 975 TITAN

MAX RPM'S:
13,300

SPECIFICATIONS

- Newly developed ceramic grain
- High level of aggression for faster cutting and high removal rates
- Best suited for use on high-powered grinders

APPLICATIONS

- Weld seam grinding
- Edge grinding and beveling
- Universal for metals and steels

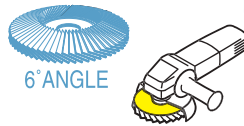

Diameter	Bore Size	Grit	Price Per Each
4-1/2"	5/8"-11	80	\$12.46
10/Box	5/8"-11	60	\$12.46
	5/8"-11	40	\$12.46

SMT 950 T-XL TITAN

MAX RPM'S:
13,300

SPECIFICATIONS

- Alumina Zirconia Grain
- 20% more flaps for our thickest disc!
- Our Longest Lasting Flap Disc
- High Level of aggression
- Offered in angled or flat for diverse applications
- Best suited for use on high powered grinders

APPLICATIONS

- Weld seam work
- Edge work/beveling
- Universal metal & steel
- Stainless steel/High alloy stainless steel

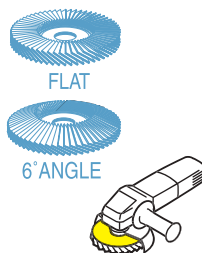

Diameter	Bore Size	Grit	Price Per Each
4-1/2"	5/8"-11	120	\$13.40
10/Box	5/8"-11	80	\$13.40
	5/8"-11	60	\$13.40
	5/8"-11	40	\$13.40

SMT 850 T TITAN

BORE SIZE: 5/8"-11



SPECIFICATIONS

- Combination of coated and non-woven abrasives
- Coated abrasive with multibond lubricant allows for cooler finishing on stainless
- Produces a beautiful satin finish
- Best results are achieved with a variable speed grinder

APPLICATIONS

- Finish grinding on flat and contoured surfaces
- Weld seam work
- Universal metal & steel
- Stainless steel/High alloy stainless steel
- Aluminum & non-ferrous metals

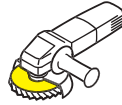

**MAX RPM = 13,300
RECOMMENDED RPM 7,000**

Diameter	Item#	Grit	Color	Price Per Each
4-1/2"	850120115T	very fine/120	green	\$25.52
5/Box	850080115T	medium/80	maroon	\$25.52
	850060115T	coarse/60	brown	\$25.52

SMT 800 T TITAN

BORE SIZE: 5/8"-11



SPECIFICATIONS

- Full non-woven abrasive flap disc
- Perfect for satin finishes on stainless
- Best results are achieved with a variable speed grinder

APPLICATIONS

- Rust & varnish removal
- Heat tinting and oxide film removal
- Universal metal & steel
- Stainless steel/High alloy stainless steel
- Aluminum & non-ferrous metals

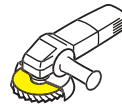

**MAX RPM = 13,300
RECOMMENDED RPM 7,000**

Diameter	Item#	Grit	Color	Price Per Each
4-1/2"	800VF115T	very fine	green	\$21.18
5/Box	800MEDM115T	medium	maroon	\$21.18
	800CRSE115T	coarse	brown	\$21.18

MINI FLAP DISCS

Mini Flap Discs are ideal for removal and blending in tight hard to reach areas. These are offered in a QRC disc for fast and convenient changeover. Mini Flap Discs are available in 2" and 3" discs, both Zirconia and Ceramic materials.

ZIRCONIA

Diameter	Grit	Item Number	Max RPM	Price Per Each
2"	120	MINISMT2ZR120	30,000	\$2.84
10/Box	80	MINISMT2ZR80	30,000	\$2.84
	60	MINISMT2ZR60	30,000	\$2.84
	40	MINISMT2ZR40	30,000	\$2.84
	36	MINISMT2ZR36	30,000	\$2.84
3"	120	MINISMT3ZR120	20,000	\$3.47
10/Box	80	MINISMT3ZR80	20,000	\$3.47
	60	MINISMT3ZR60	20,000	\$3.47
	40	MINISMT3ZR40	20,000	\$3.47
	36	MINISMT3ZR36	20,000	\$3.47

CERAMIC

Diameter	Grit	Item Number	Max RPM	Price Per Each
2"	80	MINISMT2CR80	30,000	\$3.76
10/Box	60	MINISMT2CR60	30,000	\$3.76
	40	MINISMT2CR40	30,000	\$3.76
	36	MINISMT2CR36	30,000	\$3.76
3"	80	MINISMT3CR80	20,000	\$4.57
10/Box	60	MINISMT3CR60	20,000	\$4.57
	40	MINISMT3CR40	20,000	\$4.57
	36	MINISMT3CR36	20,000	\$4.57







SMT 636 T
6° CONVEX TITAN
 Alumina Zirconia
 w/lube



Aggression:	■■■■■■■■■
Service life:	■■■■■■■□
Backing:	Trimmable Plastic, 5/8" - 11
Abrasive:	Aluminum Zirconia + Lube
Form:	convex (6°)



SMT 624 T
FLAT TITAN
 Alumina Zirconia



Aggression:	■■■■■■■□
Service life:	■■■■■■■□
Backing:	Trimmable Plastic, 5/8" - 11
Abrasive:	Aluminum Zirconia
Form:	flat



SMT 624 T
12° CONVEX TITAN
 Alumina Zirconia



Aggression:	■■■■■■■□
Service life:	■■■■■■■□
Backing:	Trimmable Plastic, 5/8" - 11
Abrasive:	Aluminum Zirconia
Form:	convex (12°)



SMT 800 T
12° CONVEX TITAN
 Non-Woven



Aggression:	■■■■□□□□
Service life:	■■■■■■■□
Backing:	Trimmable Plastic, 5/8" - 11
Abrasive:	Non-Woven
Form:	convex (12°)



SMT 850 T
12° CONVEX TITAN
 Non-Woven with
 Aluminum
 Oxide



Aggression:	■■□□□□□□
Service life:	■■■■■■■□
Backing:	Trimmable Plastic, 5/8" - 11
Abrasive:	Aluminum Oxide / Non-Woven
Form:	convex (12°)

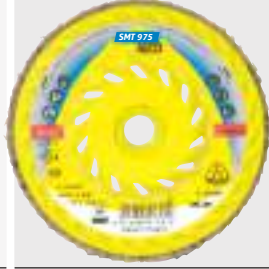

SMT 975
6° CONVEX TITAN



Aggression:	■■■■■■■□
Service life:	■■■■■■■□
Backing:	Trimmable Plastic, 5/8" - 11
Abrasive:	Newly Developed Ceramic
Form:	convex (6°)



SMT 950 T JUMBO
TITAN
6° CONVEX
FLAT



Aggression:	■■■■■■■□
Service life:	■■■■■■■□
Backing:	Trimmable Plastic, 5/8" - 11
Abrasive:	Aluminum Zirconia
Form:	convex (6°) and flat

SMT How to Choose

PRICE & PERFORMANCE



SMT 325

- Alumina Zirconia
- Aggressive grinding of steel
- Works well on low powered angle grinders.
- Won't glaze or load in low pressure situations

STAINLESS STEEL

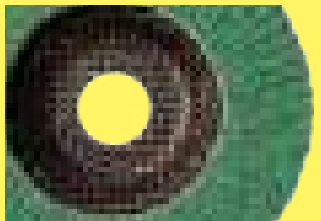

SMT 636

- Alumina Zirconia treated with a Multibond Lubricant
- Runs cooler for grinding on stainless
- Reduced clogging and loading associated with heat build up



SMT 976

- Newly developed Ceramic Grain with a Multibond Lubricant
- Aggressive disc for the most demanding applications on Stainless
- Stable grinding temperatures even during heavy grinding
- High pressure applications and high powered angle grinders

LIFE



SMT 926

- Alumina Zirconia
- High service life and aggression
- Engineered for extended life on the rough working of steel
- Well suited for grinding on high powered angle grinders



SMT 950

- Jumbo Alumina Zirconia
- Double sized flaps
- Long service life in heavy pressure applications
- Flat orientation makes this ideal for working large surface areas

AGGRESSION



SMT 624

- Alumina Zirconia
- Rapid material removal
- Angled for working contoured surfaces and edges
- Well suited for high powered grinders



SMT 628

- Alumina Zirconia
- High stock removal applications
- Flat design allows a wider grinding profile making quick time on surface work
- Well suited for high powered grinders



SMT 674

- Newly developed Ceramic Grain
- High level of aggression for faster cutting and high removal rates
- Best suited for use on high-powered grinders



SMT 940

- Alumina Zirconia
- Aggressive removal
- Flat design allows a wider grinding profile making it ideal for working flat surfaces
- Well suited for high powered grinders



SMT 974

- Newly developed Ceramic Grain
- Aggressive removal for the most rigorous grinding
- Designed to hold up to demanding edge work without breaking down or shedding
- Premium aggression disc for high powered grinders

FINISHING



SMT 800

- Full non-woven flap disc
- Used for finishing applications on stainless
- Great for creating satin finishes on stainless steel
- Works best on variable speed grinders



SMT 850

- Combination coated and non-woven
- Removal and finishing in one flap disc
- Engineered for the machining of TIG welds on stainless steel
- Creates an even finish throughout the life of the disc



Quality Classes

KLINGSPOR offers three integrated quality classes that offer each user and each application the right flap disc for the job at hand.

SPECIAL "9" SERIES

- High performance tools offering outstanding performance and service life.
- For users who need their tools to perform at peak output and reliability even if subjected to the most punishing applications



SMT 974

6° CONVEX
Ceramic grain



SMT 926

6° CONVEX
Alumina Zirconia

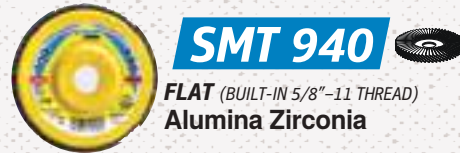

SMT 940

FLAT (BUILT-IN 5/8"-11 THREAD)
Alumina Zirconia



SMT 950

FLAT (JUMBO)
Jumbo thickness
Alumina Zirconia

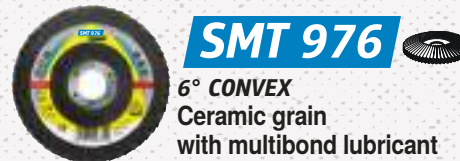

SMT 976

6° CONVEX
Ceramic grain
with multibond lubricant



SMT 800

12° CONVEX
Full non-woven
abrasive flap disc



SMT 850

12° CONVEX
Combination of coated
abrasives and
non-woven abrasives

SUPRA "6" SERIES

- Professional products with excellent life and a high stock removal rate.
- Best combination of life and aggression.
- For users who require tools that deliver reliable and powerful performance every day.



SMT 624

12° CONVEX
Alumina Zirconia



SMT 628

FLAT
Alumina Zirconia



SMT 636

6° CONVEX
Alumina Zirconia treated
with multiband lubricant

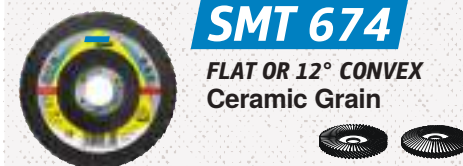

SMT 674

FLAT OR 12° CONVEX
Ceramic Grain

EXTRA "3" SERIES

- Ideal price/performance ratio for universal use.
- Offers excellent grinding results on a variety of steels.
- Quality at an affordable price.
- For users who expect their tools to meet professional standards, but do not need to use them continuously.



SMT 325

FLAT AND
12° CONVEX
Alumina Zirconia



SPECIAL CMT The ONLY Quick-Change Flap Disc

- KLINGSPOR is the ONLY producer of a quick-change flap disc
- Safe for use just like a flap disc
- Fast, convenient disc changes – perfect for production situations
- Offers the same grinding/blending as other flap discs
- Less expensive than flap discs
- Several options available for grinding and finishing



CMT 726

6° CONVEX
Alumina Zirconia



CMT 730

6° CONVEX
Alumina Zirconia
with multibond
lubricant



CMT 728

FLAT
Alumina Zirconia



CMT 800

6° CONVEX
Full non-woven
abrasive flap disc

SMT 325 EXTRA

SPECIFICATIONS **BORE SIZE: 7/8"**

- Aluminum Zirconia
- Grinding of non-ferrous metals, mild steels, and painted surfaces
- Designed to maintain removal levels on low-powered tools

APPLICATIONS

- Finish grinding on flat surfaces
- Edge work and beveling
- Universal metal & steel
- Stainless Steel



Diameter	Item#	Grit	Style	Max RPM	Price Per Each
4-1/2"	325080115022F	80	Flat	13,300	\$8.78
10/Box	325060115022F	60	Flat	13,300	\$8.78
	325040115022F	40	Flat	13,300	\$8.78
	325080115022	80	Angle	13,300	\$8.78
	325060115022	60	Angle	13,300	\$8.78
	325040115022	40	Angle	13,300	\$8.78

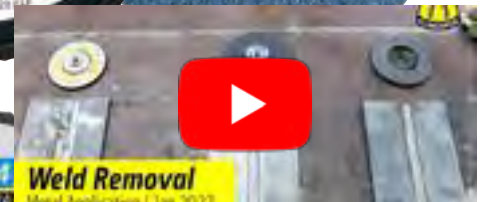

SMT 624 SUPRA

BORE SIZE: 7/8"



Diameter	Item#	Grit	Max RPM	Price Per Each
4-1/2"	624120115022	120	13,300	\$6.95
10/Box	624080115022	80	13,300	\$6.95
	624060115022	60	13,300	\$6.95
	624050115022	50	13,300	\$6.95
	624040115022	40	13,300	\$6.95
	624036115022	36	13,300	\$6.95
6"	624080150022	80	10,500	\$12.00
10/Box	624060150022	60	10,500	\$12.00
	624040150022	40	10,500	\$12.00
7"	624080178022	80	8,500	\$14.74
10/Box	624060178022	60	8,500	\$14.74
	624040178022	40	8,500	\$14.74
	624036178022	36	8,500	\$14.74

SPECIFICATIONS

- Alumina Zirconia
- High level of aggression
- Angled for effective grinding of welds, contoured surfaces, & edges
- Well suited for use on high-powered grinders

APPLICATIONS

- Weld seam work
- Edge work/beveling
- Universal metal & steel
- Stainless steel/High alloy stainless steel



SMT 628 SUPRA

BORE SIZE: 7/8"



Diameter	Item#	Grit	Max RPM	Price Per Each
4-1/2"	628120115022	120	13,300	\$6.95
10/Box	628080115022	80	13,300	\$6.95
	628060115022	60	13,300	\$6.95
	628040115022	40	13,300	\$6.95
	628036115022	36	13,300	\$6.95
	628024115022	24	13,300	\$6.95
7"	628120178022	120	8,500	\$14.74
10/Box	628080178022	80	8,500	\$14.74
	628060178022	60	8,500	\$14.74
	628050178022	50	8,500	\$14.74
	628040178022	40	8,500	\$14.74
	628036178022	36	8,500	\$14.74
	628024178022	24	8,500	\$14.74

SPECIFICATIONS

- Alumina Zirconia
- For high stock removal applications
- Flat design allows a wider grinding profile on larger flat surfaces
- Well suited for high-powered grinders

APPLICATIONS

- Finish grinding on flat surfaces
- Universal metal & steel
- Stainless steel/High alloy stainless steel



SMT 636 SUPRA

BORE SIZE: 7/8"

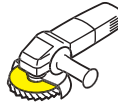

Diameter	Item#	Grit	Max RPM	Price Per Each
4-1/2"	636080115022	80	13,300	\$11.53
10/Box	636060115022	60	13,300	\$11.53
	636040115022	40	13,300	\$11.53
	636036115022	36	13,300	\$11.53
7"	630080178022	80	8,500	\$20.24
10/Box	630040178022	40	8,500	\$20.24

SPECIFICATIONS

- Alumina Zirconia with Multibond Lubricant
- High level of aggression
- Angled for effective grinding of welds, contoured surfaces, & edges
- Well suited for use on high-powered grinders



APPLICATIONS

- Weld seam work
- Edge work/beveling
- Universal metal & steel
- Stainless steel/High alloy stainless steel

SMT 674 SUPRA

BORE SIZE: 7/8" - 11



Diameter	Item#	Grit	Style	Max RPM	Price Per Each
4-1/2"	674080115022	80	Angle	12,200	\$10.67
10/Box	674060115022	60	Angle	12,200	\$10.67
	674040115022	40	Angle	12,200	\$10.67
	674080115022F	80	Flat	12,200	\$10.67
	674060115022F	60	Flat	12,200	\$10.67
	674040115022F	40	Flat	12,200	\$10.67

SPECIFICATIONS

- Newly developed ceramic grain
- High level of aggression for faster cutting and high removal rates
- Best suited for use on high-powered grinders

APPLICATIONS

- Weld seam grinding
- Edge grinding and beveling
- Universal for metals & steels



SMT 974 SPECIAL

BORE SIZE: 7/8"

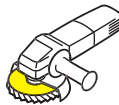

Diameter	Item#	Grit	Max RPM	Price Per Each
4-1/2"	974080115022	80	13,300	\$11.53
10/Box	974060115022	60	13,300	\$11.53
	974040115022	40	13,300	\$11.53

SPECIFICATIONS

- Newly developed ceramic grain
- Aggressive removal for the most rigorous grinding
- Designed for aggressive edge grinding without shedding
- Premium disc for high powered grinders

APPLICATIONS

- Weld seam work
- Edge work/beveling
- Universal metal & steel



SMT 926 SPECIAL

BORE SIZE: 7/8"

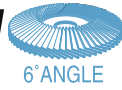

6° ANGLE

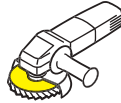

Diameter	Item#	Grit	Max RPM	Price Per Each
4-1/2"	926080115022	80	13,300	\$11.53
10/Box	926060115022	60	13,300	\$11.53
	926040115022	40	13,300	\$11.53

SPECIFICATIONS

- Alumina Zirconia
- Long service life
- Engineered for long life on rough steel work
- Well suited for use on high-powered grinders

APPLICATIONS

- Weld seam work
- Edge work/beveling
- Universal metal & steel
- Stainless steel/High alloy stainless steel



SMT 940 SPECIAL

BORE SIZE: 4-1/2" x 5/8"-11



FLAT

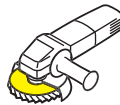

Diameter	Item#	Grit	Max RPM	Price Per Each
4-1/2"	640080115016	80	13,300	\$10.09
10/Box	640060115016	60	13,300	\$10.09
	640050115016	50	13,300	\$10.09
	640040115016	40	13,300	\$10.09
	640036115016	36	13,300	\$10.09
	640024115016	24	13,300	\$10.09

SPECIFICATIONS

- Alumina Zirconia
- Built in 5/8"-11 threaded center
- Firm, flat backing plate for aggressive grinding of flat surfaces
- Well suited for use on high-powered grinders

APPLICATIONS

- Finish grinding on flat surfaces
- Universal metal & steel
- Stainless steel/High alloy stainless steel



SMT 950 JUMBO SPECIAL

BORE SIZE: 7/8"



FLAT

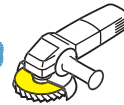

Diameter	Item#	Grit	Max RPM	Price Per Each
4-1/2"	650080115022	80	13,300	\$11.53
10/Box	650060115022	60	13,300	\$11.53
	650040115022	40	13,300	\$11.53
	650036115022	36	13,300	\$11.53

SPECIFICATIONS

- Jumbo thickness Alumina Zirconia
- Double-sized flaps
- Long service life in high-pressure applications
- Flat design allows a wider grinding profile on larger flat surfaces

APPLICATIONS

- Finish grinding on flat surfaces
- Universal metal & steel
- Stainless steel/High alloy stainless steel



SMT 976 SPECIAL

BORE SIZE: 7/8"

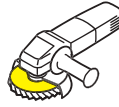

Diameter	Item#	Grit	Max RPM	Price Per Each
4-1/2"	976080115022	80	13,300	\$12.11
10/Box	976060115022	60	13,300	\$12.11
	976040115022	40	13,300	\$12.11

SPECIFICATIONS

- Newly developed Ceramic grain with multibond lubricant
- Aggressive grinding for most demanding applications on stainless
- Stable grinding temperatures during heavy grinding
- Ideal for high-pressure applications and high-powered grinders

APPLICATIONS

- Weld seam work
- Edge work/beveling
- Universal metal & steel
- Stainless steel/High alloy stainless steel
- Non-ferrous metals



SMT 800 SPECIAL

BORE SIZE: 7/8"

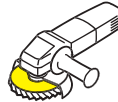

Diameter	Item#	Grit	Max RPM	Price Per Each
4-1/2"	800CRSE115022	Coarse/60	7,000	\$19.64
5/Box	800MEDM115022	Medium/80	7,000	\$19.64
	800VFIN115022	Very Fine/120	7,000	\$19.64

SPECIFICATIONS

- Full non-woven abrasive flap disc
- Perfect for satin finishes on stainless
- Best results are achieved with a variable speed grinder

APPLICATIONS

- Rust & varnish removal
- Heat tinting and oxide film removal
- Universal metal & steel
- Stainless steel/High alloy stainless steel
- Aluminum & non-ferrous metals



SMT 850 SPECIAL

BORE SIZE: 7/8"

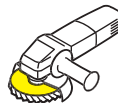

Diameter	Item#	Grit	Max RPM	Price Per Each
4-1/2"	850120115022	Coarse/60	7,000	\$23.67
5/Box	850080115022	Medium/80	7,000	\$23.67
	850060115022	Very Fine/120	7,000	\$23.67

SPECIFICATIONS

- Combination of coated abrasives and non-woven abrasives
- Coated abrasive with multibond lubricant allows for cooler finishing on stainless
- Produces a beautiful satin finish
- Best results are achieved with a variable speed grinder

APPLICATIONS

- Finish grinding on flat and contoured surfaces
- Weld seam work
- Stainless steel/High alloy stainless steel
- Aluminum & non-ferrous metals



NCD 200HD SPECIAL

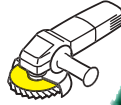

POWER WHEEL

Diameter	Bore Size	Max RPM	Price Per Each
4-1/2"	7/8"	10,450	\$22.01
5/Box			

SPECIFICATIONS

- Ceramic Coated Aluminum Oxide
- Heavy duty
- Non-clogging due to open structure

APPLICATIONS

- Rust and mill scale removal
- Aggressive cleaning of paint, varnishes or other surface coatings
- Performs well on all metals, stainless steel and plastics

NCD 200 SPECIAL

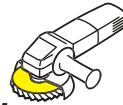

POWER WHEEL

Diameter	Bore Size	Max RPM	Price Per Each
4-1/2"	7/8"	10,450	\$16.90
5/Box			

SPECIFICATIONS

- Special Silicon Carbide Non-woven web
- High edge strength
- Non-clogging due to open structure

APPLICATIONS

- Rust and mill scale removal
- Aggressive cleaning of paint, varnishes or other surface coatings
- Performs well on all metals, stainless steel and plastics



SCAN TO WATCH
CEVOLUTION
IN ACTION

CEVOLUTION

SMT 974 SPECIAL



SOLID

Blended cotton backing transforms the flap disc into a grinding powerhouse! The extra thick layer of abrasive material gives the product an exceptionally long service life.

SMT 976 SPECIAL



COOL TEMP

Added multi-bond reduces heat, making it great for aggressive grinding on stainless steel!

SMT 674 SUPRA



EFFICIENT

Cost-effective price while not sacrificing the performance of the ceramic grain!

SMT 975 TITAN



LONGEST LASTING

Our Titan flap disc features a firm plastic fan-shaped trimmable backing with a 5/8-11" hub! (no wrench needed!)





CMT – Quick Affix Flap Discs

Simply affix the die-cast backing plate to your angle grinder using a standard locking nut and leave it there. Then the CMT "loadings" are locked into place with a quick turn of the wrist. No tools are necessary to accomplish the task, which only takes seconds. When a new grinding surface is needed or when grits need to be changed, twist the CMT off and put a new one on. No more fumbling with the grinder's locking nut each time - twist on, twist off. Choose Klingspor's CMTs for high production settings to reduce downtime or diverse applications in a job shop. Maximum RPM 12,000.

CMT 726 - ALUMINA ZIRCONIA



6° CONVEX

Diameter	Grit	Price Per Each
4-1/2"	120	\$7.97
10/Box	80	\$7.97
	60	\$7.97
	40	\$7.97

CMT 730 - MULTIBOND ALUMINA ZIRCONIA



6° CONVEX

Diameter	Grit	Price Per Each
4-1/2"	80	\$9.26
10/Box	60	\$9.26
	40	\$9.26

CMT 728 - ALUMINA ZIRCONIA

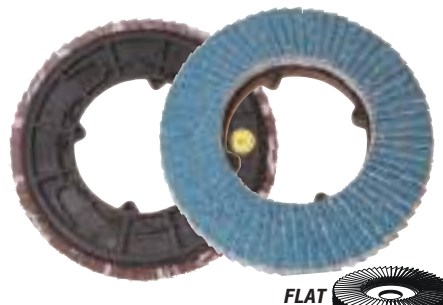

FLAT

Diameter	Grit	Price Per Each
4-1/2"	120	\$7.97
10/Box	80	\$7.97
	60	\$7.97
	40	\$7.97

CMT 800 - NON-WOVEN



6° CONVEX

Diameter	Grit	Price Per Each
4-1/2"	Coarse	\$15.02
5/Box	Medium	\$15.02
	Very Fine	\$15.02

RECOMMENDED RPM 7,000 RPM



Special "channels" ensure that the CMT is securely locked in place.



The steel CMT backing plate.



Place the backing plate on your angle grinder.



CMT backing plate on angle grinder.



Use your standard locking nut to fasten the backing plate in place.



Match the CMT "loading" to the backing plate.

(Note: tighten locking nut with spanner wrench. Do not hand tighten)



4-1/2" BACKING PLATE:
555CMTBACKPLATE115..... \$9.14



ADJUSTABLE SPANNER WRENCH
#BPS900001 \$22.59

Fibre Discs



CS 561 ALUMINUM OXIDE FIBRE DISCS

These aluminum oxide discs are perfect for most metal grinding applications where major stock removal is NOT necessary. Removal of surface contaminants and smoothing of mild weld seams are the CS 561's forte.

Diameter	Box Qty	Max RPM	80 Grit+	60 Grit	50 Grit	40 Grit	36 Grit	24 Grit	16 Grit
4" x 5/8"	25	14,400	\$31.88	\$34.63	\$36.27	N/A	\$39.03	\$40.13	\$50.02
4-1/2" x 7/8"	25	13,300	\$35.18	\$37.94	\$39.03	\$40.66	\$41.76	\$43.42	\$54.43
5" x 7/8"	25	12,200	\$39.03	\$40.67	\$43.42	\$45.07	\$46.18	\$47.82	\$61.56
7" x 7/8"	25	8,600	\$61.56	\$65.41	\$67.06	\$70.90	\$72.56	\$75.30	\$95.09
9" x 7/8"	25	6,600	\$80.80	\$86.29	\$90.69	N/A	\$96.19	\$98.93	\$126.96



CS 565 ALUMINA ZIRCONIA FIBRE DISCS

For heavier stock removal and faster cutting, the CS 565 cannot be beat. The tough alumina zirconia grains cut with a vengeance to take your workpiece to a more finished state.

Diameter	Box Qty	Max RPM	100/80 Grit	60 Grit	50 Grit	36 Grit	24 Grit
4-1/2" x 7/8"	25	12,200	\$43.80	\$46.47	\$48.40	\$52.89	\$55.55
5" x 7/8"	25	8,600	\$55.55	\$58.22	\$60.90	\$66.24	\$69.43
7" x 7/8"	25	6,600	\$77.45	\$81.73	\$83.86	\$91.34	\$94.54

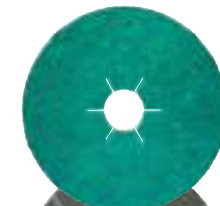

CS 570 LUBRICATED ALUMINA ZIRCONIA FIBRE DISCS

Also an alumina zirconia disc, the CS 570 has an added advantage - a dry lubricant. This feature aids in reducing heat build-up for a cleaner, cooler cut. The CS 570 is especially useful in those applications where grinding heat can discolor the workpiece.

Diameter	Box Qty	Max RPM	120/80 Grit	60 Grit	50 Grit	36 Grit	24 Grit
4-1/2" x 7/8"	25	12,200	\$43.80	\$46.47	\$48.50	\$52.89	\$55.55
5" x 7/8"	25	8,600	\$77.45	\$81.73	\$83.86	\$91.34	\$69.43



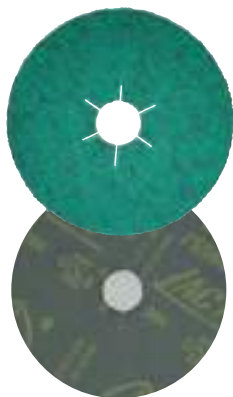

Fibre Discs

FS 966 LUBRICATED CERAMIC FIBRE DISCS

For the optimum in life and grinding consistency, these ceramic aluminum oxide lubed fibre disc cannot be beat. The tough ceramic grain cuts fast and lasts longer than any other grain type on hard steels and metals.

Diameter	Box Qty	Max RPM	80 Grit+	60 Grit	50 Grit	40 Grit	36 Grit	24 Grit
4-1/2" x 7/8"	25	13,000	\$62.64	\$65.75	\$71.01	\$74.00	\$81.38	\$93.92
5" x 7/8"	25	12,200	\$84.64	\$88.86	\$95.97	\$98.45	\$108.34	\$124.71
7" x 7/8"	25	8,600	\$135.55	\$142.33	\$153.70	\$162.36	\$178.59	\$205.16

FS 964 CERAMIC FIBRE DISCS

Comprised of tough ceramic grains, fully resin bonded to a heavy vulcanized fiber backing. Ideal for carbon steel and heavy stock removal.

Diameter	Box Qty	Max RPM	120 Grit	80 Grit	60 Grit	50 Grit	40 Grit	36 Grit	24 Grit
4-1/2" x 7/8"	25	13,000	\$54.45	\$56.36	\$59.16	\$63.83	\$66.61	\$73.24	\$84.53
5" x 7/8"	25	12,200	\$70.45	\$76.18	\$79.98	\$86.43	\$88.62	\$97.31	\$112.26
7" x 7/8"	25	8,600	\$115.90	\$121.98	\$128.08	\$138.38	\$146.15	\$160.72	\$184.62

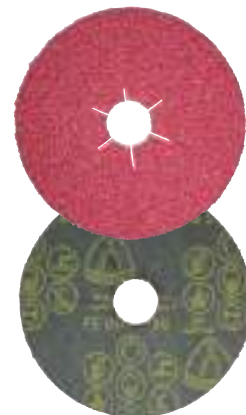

FIBRE DISC BACKING PAD

*5/8"-11 Lock Nut Included

Diameter	Item #	Max RPM	Price
4-1/2" (5/8" - 11)*	BP001	13,000	\$30.66
4-1/2" (5/8" - 11)*	ST358A-115	13,000	\$30.67
4-1/2" spiralcool	BPS012	13,500	\$55.20
5" (5/8" - 11)*	BP002	12,000	\$36.21
5" (5/8" - 11)*	ST358A-125	12,000	\$36.21
5" spiralcool	BPS011	13,000	\$66.60
7" (5/8" - 11)*	BP003	8,500	\$54.04
7" (5/8" - 11)*	ST358A-180	8,500	\$54.05
7" spiralcool	BPS010	8,600	\$80.63
9" (5/8" - 11)*	BP004	6,600	\$70.01



Standard Pad

Spiral Cool Pad



PHENOLIC BACKING PLATES

Dia.	Item #	RPM	Price
4-1/2"	FBP-4.5	6,000	\$8.60
5"	FBP-5	6,000	\$8.60
7"	FBP-7	6,000	\$11.46

Quick Lock Fibre Discs

Production shops will appreciate the quick on, quick off use of KLINGSPOR's Quick Lock Fibre Discs. Changing of discs or switching between grits takes only a few seconds. Use only with KLINGSPOR's Quick Lock Backing Pads.



CS 561 ALUMINUM OXIDE

Diameter	Grit	Price Per Box
4-1/2" x 7/8" 25/Box 13,300 RPM	80+	\$62.78
	60	\$65.60
	50	\$66.70
	40	\$68.49
	36	\$69.64
	24	\$71.36
5" x 7/8" 25/Box 12,200 RPM	80+	\$66.75
	60	\$69.04
	50	\$71.37
	40	\$73.22
	36	\$74.23
	24	\$75.97
7" x 7/8" 25/Box 8,600 RPM	80+	\$90.36
	60	\$93.23
	50	\$96.09
	40	\$98.97
	36	\$101.85
	24	\$104.76
9" x 7/8" 25/Box 6,600 RPM	80+	\$97.42
	60	\$99.61
	50	\$110.48
	36	\$116.20
	24	\$120.84
	16	\$158.84

CS 565 ALUMINA ZIRCONIA

Diameter	Grit	Price Per Box
4-1/2" x 7/8" 25/Box 13,000 RPM	80	\$71.02
	60	\$73.83
	50	\$77.19
	36	\$80.54
	24	\$83.33
	20	\$86.12
5" x 7/8" 25/Box 12,200 RPM	80	\$83.33
	60	\$86.12
	50	\$88.92
	36	\$94.53
	24	\$97.62
	20	\$102.15
7" x 7/8" 25/Box 8,600 RPM	80	\$106.26
	60	\$110.72
	50	\$112.98
	36	\$120.79
	24	\$124.15
	20	\$128.51
9" x 7/8" 25/Box 6,600 RPM	80	\$166.41
	60	\$178.96
	50	\$181.78
	36	\$198.52
	24	\$201.90
	20	\$214.35

FS 966 LUBRICATED CERAMIC ACT

Diameter	Grit	Price Per Box
4-1/2" x 7/8" 25/Box 13,000 RPM	80	\$89.18
	60	\$90.31
	50	\$97.72
	40	\$101.63
	36	\$108.23
	24	\$120.84
5" x 7/8" 25/Box 12,200 RPM	80	\$111.57
	60	\$113.90
	50	\$123.15
	40	\$135.26
	36	\$143.81
	24	\$152.38
7" x 7/8" 25/Box 8,600 RPM	80	\$185.90
	60	\$195.50
	50	\$204.54
	40	\$213.60
	36	\$245.28
	24	\$281.78

5/8" - 11 LOCKING NUT

#BP9825.....\$5.31

CS 570 LUBRICATED ALUMINA ZIRCONIA

Diameter	Grit	Price Per Box
4-1/2" x 7/8" 25/Box 13,000 RPM	80	\$71.02
	60	\$73.83
	50	\$76.06
	36	\$80.54
	24	\$83.33
	20	\$86.12
5" x 7/8" 25/Box 12,200 RPM	80	\$83.34
	60	\$86.14
	50	\$88.92
	36	\$94.50
	24	\$97.87
	20	\$102.24
7" x 7/8" 25/Box 8,600 RPM	80	\$106.26
	60	\$110.72
	50	\$112.98
	36	\$120.79
	24	\$124.15
	20	\$128.51
9" x 7/8" 25/Box 6,600 RPM	80	\$196.29
	60	\$196.29
	50	\$198.52
	36	\$198.52
	24	\$201.52
	20	\$204.52

FS 964 CERAMIC ACT

Diameter	Grit	Price Per Box
4-1/2" x 7/8" 25/Box 13,000 RPM	80	\$81.26
	60	\$83.54
	50	\$87.51
	40	\$91.47
	36	\$100.57
	24	\$116.09
5" x 7/8" 25/Box 12,200 RPM	80	\$106.77
	60	\$109.87
	50	\$118.65
	40	\$121.74
	36	\$133.67
	24	\$154.19
7" x 7/8" 25/Box 8,600 RPM	80	\$167.56
	60	\$175.96
	50	\$186.83
	40	\$201.90
	36	\$216.96
	24	\$249.24

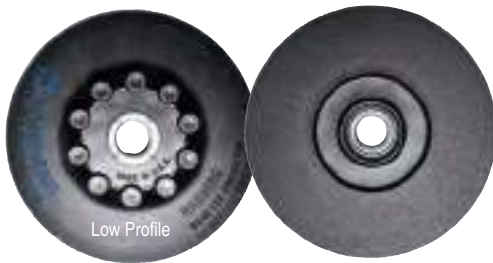

QUICK LOCK BACKING PAD

Diameter	Item #	Max RPM	Price Per Pad
4-1/2"	BPQ001	20,000	\$72.44
4-1/2" Low Profile	BPQ002	20,000	\$72.44
5"	BPQ003	20,000	\$72.44
5" Low Profile	BPQ004	20,000	\$72.44
7" Soft	BPQ005	8,600	\$94.89
7" Medium	BPQ006	8,600	\$81.52
7" Firm	BPQ007	8,600	\$94.89
9" Medium	BPQ008	7,000	\$113.45



Bonded Abrasive Reference

○ Possible Application, ● Ideal Application

Description	Type	Thickness	Steel	Hardened Steels	Tool Steel	Stainless Steel	High Alloy Steels	Corrosion & Acid Proof Steels	Aluminum	Bronze	Copper	Brass	Zinc, Die-Casting	Cast Iron	Stone/Concrete	Asphalt
Cut Off Wheel for Angle Grinder	A 980 TZ SPECIAL	1/32	●	●	●	●	●	●	○	○	○	○	○	○	○	○
	A 960 TZ SPECIAL	.045	●	●	●	●	●	●	○	○	○	○	●	○		
	Z 960 TX SPECIAL	.045	●	●	●	●	●	●	○	○	○	○	●	○		
	K 960 TX SPECIAL	.045	●	●	●	●	●	●	○	○	○	○	●	●		
	A 60 TZ SPECIAL INOX	.045	●	●	●	●	●	●	○	○	○	○	●	○		
	A 60 N SUPRA	.045	○	○	○	○	○	○	●	●	●	●	○	○		
	A 46 TZ SPECIAL INOX	1/16	●	●	●	●	●	●	○	○	○	○	○	○		
	A 946 TZ SPECIAL	1/16	●	●	●	●	●	●	○	○	○	○	○	○		
	A 24 R SUPRA	3/32 - 1/8	●	●	●	○	○	○						○	○	
Die Grinder	A 660 R SUPRA small cut off wheel	3/64 - 1/16	●	●	●	●	○	○	○	○	○	○	○	○		
for Low Powered Chop Saw	A 330 E SPECIAL	1/8	●	○	○	○	○	○	○	○	○	○	○	○		
	A 630 N SUPRA	3/32	●	○	○	○	○	○	○	○	○	○	○	○		
	A 930 N SPECIAL	1/8	●	○	○	○	○	○	○	○	○	○	○	○		
for Stationary Machine	A 24 R SUPRA	1/8 - 3/16	●	●	●	○	○							○		
for Gas Powered Saw	A 924 R SPECIAL	9/64 - 5/32	●	●	●	●	●	●							○	
	A 924 SX SPECIAL	5/32	●	●												
Dual Use for Angle Grinder	TS 30 AP SPECIAL	1/8	○	○	●	●	●	●								
	A 46 VZ SPECIAL	5/64	○	○	●	●	●	●								
Grinding Discs for Angle Grinder	A 24 R SUPRA	1/4	●	●	●	○	○	○							○	
	A 24 N SUPRA INOX	1/4	○	●	○	●	●	●							○	
	A 624 T SPECIAL	1/4	●	●	●	○	○	○							●	
	A 30 M SPECIAL	1/4	○	●	○	●	●	●							○	
	A 46 N SUPRA	1/4							●	○	○	○	○			



A 946 TZ

A 960 TZ



CERAMIC K 960 TX SPECIAL

Stainless Steel, Stainless Steel Sheets, Container Construction and Metal Fabrication

Size	Box Qty	Max RPM	Item#	Price Per Disc
4-1/2" x .045" x 7/8"	25	13,300	K960TX1151.022F	\$5.51
5" x .045" x 7/8"	25	12,200	K960TX1251.022F	\$6.18



ALUMINA ZIRCONIA Z 960 TX SPECIAL

Stainless Steel, Stainless Steel Sheets, Container Construction and Metal Fabrication

Size	Box Qty	Max RPM	Item#	Price Per Disc
4-1/2" x .045" x 7/8" TYPE 27	25	13,300	Z960TX1151.022D	\$4.80
5" x .045" x 7/8" TYPE 27	25	12,200	Z960TX1251.022D	\$5.37
4-1/2" x .045" x 7/8"	25	13,300	Z960TX1151.022F	\$4.80
5" x .045" x 7/8"	25	12,200	Z960TX1251.022F	\$5.37



ALUMINUM OXIDE A 960 TZ SPECIAL

Stainless Steel, Stainless Steel Sheets, Container Construction, Carbon Steel and Metal Fabrication

Size	Box Qty	Max RPM	Item#	Price Per Disc
4-1/2" x .045" x 7/8" TYPE 27	25	13,300	A960TZ1151.022D	\$4.35
5" x .045" x 7/8" TYPE 27	25	12,200	A960TZ1251.022D	\$4.89
4-1/2" x .045" x 7/8"	25	13,300	A960TZ1151.022F	\$4.35
5" x .045" x 7/8"	25	12,200	A960TZ1251.022F	\$4.89



ALUMINUM OXIDE A 980 TZ SPECIAL

Stainless Steel Sheets, Container Construction, Carbon Steel Sheets and Metal Fabrication

Size	Box Qty	Max RPM	Item#	Price Per Disc
4-1/2" x 1/32" x 7/8" TYPE 27	25	13,300	A980TZ1150.822D	\$4.83
5" x 1/32" x 7/8" TYPE 27	25	12,200	A980TZ1250.822D	\$5.32





A 46 TZ SPECIAL

Stainless Steel, Stainless Steel Sheets, Carbon Steel, Container Construction and Metal Fabrication



Size	Box Qty	Max RPM	Item#	Price Per Disc
4" x 1/16" x 5/8"	25	13,300	A46TZ1001.616F	\$3.58
4-1/2" x 1/16" x 7/8" TYPE 27	25	13,300	A46TZ1151.622D	\$3.70
4-1/2" x 1/16" x 7/8"	25	13,300	A46TZ1151.622F	\$3.70
5" x 1/16" x 7/8"	25	12,200	A46TZ1251.622F	\$4.38
6" x 1/16" x 7/8"	25	10,200	A46TZ1501.622F	\$4.54
6" x 1/16" x 7/8" TYPE 27	25	10,200	A46TZ1501.622D	\$4.54
7" x 1/16" x 7/8"	25	8,500	A46TZ1781.622F	\$5.66
7" x 1/16" x 7/8" TYPE 27	25	8,500	A46TZ1781.622D	\$5.66
9" x 5/64" x 7/8"	25	6,600	A46TZ2301.922F	\$7.22
9" x 5/64" x 7/8" TYPE 27	25	6,600	A46TZ2301.922D	\$7.22



A 946 TZ SPECIAL

Stainless Steel, Stainless Steel Sheets, Carbon Steel, Container Construction and Metal Fabrication



Size	Box Qty	Max RPM	Item#	Price Per Disc
4-1/2" x 1/16" x 7/8"	25	13,300	A946TZ1151.622F	\$4.36
5" x 1/16" x 7/8"	25	12,200	A946TZ1251.622F	\$5.13
6" x 1/16" x 7/8"	25	10,200	A946TZ1501.622F	\$5.36
7" x 1/16" x 7/8"	25	8,500	A946TZ1781.622F	\$6.66
9" x 5/64" x 7/8"	25	6,600	A946TZ2301.922F	\$8.55



A 60 TZ SPECIAL

Stainless Steel, Stainless Steel Sheets, Carbon Steel, Container Construction and Metal Fabrication



Size	Box Qty	Max RPM	Item#	Price Per Disc
4" x .045" X 5/8"	25	15,300	A60TZ1001.016F	\$4.21



A 60 N SUPRA

Non-Ferrous Metals, Aluminum, Copper and Brass. Soft Structure Prevents Loading



Size	Box Qty	Max RPM	Item#	Price Per Disc
4-1/2" x .045" x 7/8"	25	13,300	A60N1151.022F	\$4.83
5" x .045" x 7/8"	25	12,200	A60N1251.022F	\$5.32

A 660 R SMALL CUT-OFF WHEELS



Size	Box Qty	Max RPM	Item#	Price Per Disc
2" x 3/64" x 1/4"	40	30,600	A660R0501.006F-40	\$3.15
3" x 3/64" x 1/4"	40	20,100	A660R0761.006F-40	\$3.15
3" x 3/64" x 3/8"	40	20,100	A660R0761.010F-40	\$3.15
3" x 1/16" x 1/4"	40	20,100	A660R0761.606F-40	\$3.15
3" x 1/16" x 3/8"	40	20,100	A660R0761.610F-40	\$3.15
4" x 3/64" x 1/4"	25	15,200	A660R1001.006F	\$3.71
4" x 3/64" x 3/8"	25	15,200	A660R1001.010F	\$3.71



A 660 R MANDREL

1/4" & 3/8" ARBOR1/4-3/8X1/4SL \$18.20/per mandrel



A 24 R SUPRA

Steel, Structural Steel, Tool Steel, Sheet Steel

Size	Box Qty	Max RPM	Item#	Price Per Disc
4" x 3/32" x 5/8"	25	15,300	A24R1002.516D	\$3.71
4-1/2" x 3/32" x 7/8"	25	13,300	A24R1152.522D	\$3.94
5" x 3/32" x 7/8"	25	12,200	A24R1252.522D	\$4.46
7" x 1/8" x 7/8"	25	8,500	A24R1783.022D	\$5.52
7" x 1/8" x 5/8"-11 hub	10	8,500	A24R1783.022A	\$8.35
9" x 1/8" x 5/8"-11 hub	10	6,600	A24R2303.022A	\$12.31

Size	Box Qty	Max RPM	Item#	Price Per Disc
4" x 3/32" x 5/8"	25	15,300	A24R1002.516F	\$3.71
4-1/2" x 3/32" x 7/8"	25	13,300	A24R1152.522F	\$3.94
5" x 3/32" x 7/8"	25	12,200	A24R1252.522F	\$4.46
6" x 3/32" x 7/8"	25	10,200	A24R1502.522F	\$5.32

for Stationary Machines

KLINGSPOR's general purpose wheels for stationary saws provide reliable performance every time. The rigors of these applications are handled effectively and economically.



A 24 R SUPRA

Steel, Structural Steel, Tool Steel, Sheet Steel
> 3KW or 4HP Machines

Size	Box Qty	Max RPM	Item#	Price Per Disc
12" x 1/8" x 1"	10	6,400	A24R3003.025F	\$14.24
14" x 9/64" x 1"	10	5,500	A24R3503.525F	\$20.01
16" x 3/16" x 1"	10	4,800	A24R4004.025F	\$24.56





A 924 R SPECIAL

Steel, Ductile Iron, Structural Steel, Tool Steel

Size	Box Qty	Max RPM	Item#	Price Per Disc
12" x 9/64" x 20 mm	10	5,100	A924R3003.520F	\$14.04
14" x 5/32" x 20 mm	10	4,400	A924R3504.020F	\$22.59
14" x 5/32" x 1"	10	4,400	A924R3504.025F	\$20.54



A 924 SX SPECIAL

Railroad Tracks and Steel

Best performance on high powered saws

Size	Box Qty	Max RPM	Item#	Price Per Disc
14" x 5/32" x 1"	10	5,500	A924SX3504.025F	\$26.60
16" x 5/32" x 1"	10	4,800	A924SX4004.025F	\$33.73

* MAX OPERATING SPEED 100 M/S



CHOOSING THE BEST
CHOP SAW WHEEL
FOR YOUR NEEDS



For fast-cutting action and overall performance on chopsaw machines, these general purpose wheels will accomplish your goals. For use on low-power, 110/120v chopsaws.

A 330 N SPECIAL

All Metals < 3KW or 4HP Universal Wheel on Solid Material

Size	Box Qty	Max RPM	Item#	Price Per Disc
12" x 3/32" x 1"	10	5,100	A330N3002.525F FC	\$14.72
16" x 9/64" x 1"	10	3,800	A330N4003.525F FC	\$22.15

A 630 N SUPRA FAST CUT

All Metals < 3KW or 4HP Universal Wheel on Hollow Material

Size	Box Qty	Max RPM	Item#	Price Per Disc
14" x 3/32" x 1"	10	4,400	A630N3502.525F FC	\$12.76

A 930 N SPECIAL

All Metals < 3KW or 4HP Universal Wheel on Solid Material

Size	Box Qty	Max RPM	Item#	Price Per Disc
14" x 1/8" x 1"	10	4,400	A930N3503.025F FC	\$16.75

Two specialty wheels for pipe fabrication are the Duplex A 46 VZ and the Pipeline TS 30 AP. Both are approved for use on stainless and carbon steels and triple fiberglass reinforcements allow for light grinding, notching and safe cutting.

TS 30 AP SPECIAL

Pipeline, Tank Fabrication, Root Seams

Size	Box Qty	Max RPM	Item#	Price Per Disc
4-1/2" x 1/8" x 7/8"	10	13,300	TS30AP1153.522D	\$4.36
4-1/2" x 1/8" x 5/8" - 11	10	13,300	TS30AP1153.522A	\$5.97
5" x 1/8" x 7/8"	10	12,200	TS30AP1253.522D	\$4.74
5" x 1/8" x 5/8" - 11	10	12,200	TS30AP1253.522A	\$6.32
6" x 1/8" x 7/8"	10	10,200	TS30AP1503.522D	\$5.13
6" x 1/8" x 5/8" - 11	10	10,200	TS30AP1503.522A	\$6.71
7" x 1/8" x 7/8"	10	8,600	TS30AP1783.722D	\$6.28
7" x 1/8" x 5/8" - 11	10	8,600	TS30AP1783.722A	\$8.20

DUPLEX A 46 VZ SPECIAL

Extra thin and efficient for cutting AND safe grinding.

Size	Box Qty	Max RPM	Item#	Price Per Disc
4-1/2" x 5/64" x 7/8" DUPLEX	25	13,300	A46VZ1152.022D	\$6.72

Safe for cutting & light grinding

Whether you're grinding welds, smoothing out pits or cutting bar stock or concrete, the Klingspor Yellow Extra line should be your choice for maximum performance at a reasonable cost. Try these wheels from KLINGSPOR - the world leader in the development and production of high speed cut off wheels and grinding discs. Grit numbers beginning with "A" are suitable for use on most metals and steels. Grit numbers beginning with a "C" are suitable for most masonry applications.



TOP DISC IN THE INDUSTRY FOR MILD STEEL

A 24 R SUPRA

Steel, Structural Steel, Tool Steel, Sheet Steel

Size	Box Qty	Max RPM	Item#	Price Per Disc
4" x 5/32" x 5/8"	10	15,300	A24R1004.016D	\$4.34
4" x 1/4" x 5/8"	10	15,300	A24R1006.016D	\$5.16
4-1/2" x 3/16" x 7/8"	10	13,300	A24R1154.022D	\$4.57
4-1/2" x 3/16" x 5/8"-11 hub	10	13,300	A24R1154.022A	\$7.15
4-1/2" x 1/4" x 7/8"	10	13,300	A24R1156.022D	\$5.51
4-1/2" x 1/4" x 5/8"-11 hub	10	13,300	A24R1156.022A	\$8.32
5" x 1/4" x 7/8"	10	12,200	A24R1256.022D	\$5.74
5" x 1/4" x 5/8"-11 hub	10	12,200	A24R1256.022A	\$8.56
6" x 1/4" x 7/8"	10	10,200	A24R1506.022D	\$7.26
6" x 1/4" x 5/8"-11 hub	10	10,200	A24R1506.022A	\$10.08
7" x 1/4" x 7/8"	10	8,500	A24R1786.022D	\$9.61
7" x 1/4" x 5/8"-11 hub	10	8,500	A24R1786.022A	\$12.43
7" x 5/16" x 7/8"	10	8,500	A24R1788.022D	\$11.85
9" x 1/4" x 7/8"	10	6,600	A24R2306.022D	\$16.32
9" x 1/4" x 5/8"-11 hub	10	6,600	A24R2306.022A	\$19.11



Grinding vs **FIBRE** vs SMT



A 24 N SUPRA

Stainless Steel, Non-Alloy Stainless Steel, High Alloy Stainless Steel

Size	Box Qty	Max RPM	Item#	Price Per Disc
4-1/2" x 1/4" x 7/8"	10	13,300	A24N1156.022D	\$6.27
4-1/2" x 1/4" x 5/8"-11 hub	10	13,300	A24N1156.022A	\$9.17
5" x 1/4" x 7/8"	10	12,200	A24N1256.022D	\$6.87
7" x 1/4" x 7/8"	10	8,500	A24N1786.022D	\$10.86
7" x 1/4" x 5/8"-11 hub	10	8,500	A24N1786.022A	\$13.76
9" x 1/4" x 7/8"	10	6,600	A24N2306.022D	\$18.34
9" x 1/4" x 5/8"-11 hub	10	6,600	A24N2306.022A	\$21.22



A 624 T SUPRA

Cast Iron, Cast Steel, Hardened Steel

Size	Box Qty	Max RPM	Item#	Price Per Disc
4-1/2" x 1/4" x 7/8"	10	13,300	A624T1156.022D	\$5.21
4-1/2" x 1/4" x 5/8"-11 hub	10	13,300	A624T1156.022A	\$7.68
5" x 1/4" x 7/8"	10	12,200	A624T1256.022D	\$6.05
5" x 1/4" x 5/8"-11 hub	10	12,200	A624T1256.022A	\$8.52
7" x 1/4" x 7/8"	10	8,500	A624T1786.022D	\$10.86
7" x 1/4" x 5/8"-11 hub	10	8,500	A624T1786.022A	\$13.41
9" x 1/4" x 7/8"	10	6,600	A624T2306.022D	\$17.36
9" x 1/4" x 5/8"-11 hub	10	6,600	A624T2306.022A	\$20.17



A 30 M SPECIAL

2 in 1 Grinding Disc for Carbon Steel & Stainless Steel

Size	Box Qty	Max RPM	Item#	Price Per Disc
4-1/2" x 1/4" x 7/8"	10	13,300	A30M1156.022D	\$8.62
4-1/2" x 1/4" x 5/8"-11 hub	10	13,300	A30M1156.022A	\$11.33
5" x 1/4" x 7/8"	10	12,200	A30M1256.022D	\$9.35
5" x 1/4" x 5/8"-11 hub	10	12,200	A30M1256.022A	\$12.04



A 46 N SUPRA

Aluminum & Non-Ferrous

Size	Box Qty	Max RPM	Item#	Price Per Disc
4-1/2" x 1/4" x 7/8"	10	13,300	A46N1156.022D	\$6.09
4-1/2" x 1/4" x 5/8"-11 hub	10	13,300	A46N1156.022A	\$8.91
5" x 1/4" x 7/8"	10	12,200	A46N1256.022D	\$6.68
5" x 1/4" x 5/8"-11 hub	10	12,200	A46N1256.022A	\$9.49
7" x 1/4" x 7/8"	10	8,500	A46N1786.022D	\$10.55
7" x 1/4" x 5/8"-11 hub	10	8,500	A46N1786.022A	\$13.37



ALUMINUM OXIDE



Must be used with KLINGSPOR's Steel Mandrels.

Diameter	Grit	Price Per Box
3/4"	100+	\$71.29
	100/Box	\$71.29
	30,000 RPM	\$73.75
	50	\$75.65
	40	\$78.64
1"	100+	\$71.29
	100/Box	\$71.29
	30,000 RPM	\$73.75
	50	\$75.65
	40	\$78.64
1-1/2"	100+	\$88.51
	100/Box	\$88.51
	30,000 RPM	\$89.69
	50	\$92.64
	40	\$92.64
2"	100+	\$129.62
	100/Box	\$129.62
	20,000 RPM	\$131.29
	50	\$136.53
	40	\$140.28
3"	100+	\$81.05
	50/Box	\$82.84
	20,000 RPM	\$84.70
	50	\$87.09
	40	\$89.86
4"	100+	\$67.88
	25/Box	\$69.39
	20,000 RPM	\$70.94
	50	\$72.93
	40	\$75.25
	36	\$77.55
	24	\$82.80

ALUMINA ZIRCONIA



Must be used with KLINGSPOR's Steel Mandrels.

Diameter	Grit	Price Per Box
3/4"	120	\$85.55
	100/Box	\$85.55
	30,000 RPM	\$88.52
	50	\$90.81
	40	\$94.34
1"	120	\$85.55
	100/Box	\$85.55
	30,000 RPM	\$88.52
	50	\$90.81
	40	\$94.34
1-1/2"	120	\$85.55
	100/Box	\$85.55
	30,000 RPM	\$88.52
	50	\$90.81
	40	\$94.34
2"	120	\$85.55
	100/Box	\$85.55
	30,000 RPM	\$88.52
	50	\$90.81
	40	\$94.34
3"	120	\$85.55
	100/Box	\$85.55
	30,000 RPM	\$88.52
	50	\$90.81
	40	\$94.34
4"	120	\$85.55
	100/Box	\$85.55
	30,000 RPM	\$88.52
	50	\$90.81
	40	\$94.34

**ALUMINA ZIRCONIA
- LUBRICATED**



Must be used with KLINGSPOR's Steel Mandrels.

Diameter	Grit	Price Per Box
3/4"	120	\$102.62
	100/Box	\$102.62
	30,000 RPM	\$106.21
	50	\$108.98
	40	\$113.23
1"	120	\$102.62
	100/Box	\$102.62
	30,000 RPM	\$106.21
	50	\$108.98
	40	\$113.23
1-1/2"	120	\$127.46
	100/Box	\$127.46
	30,000 RPM	\$129.23
	50	\$133.67
	40	\$133.46
2"	100+	\$182.94
	100/Box	\$186.67
	20,000 RPM	\$189.07
	50	\$196.63
	40	\$202.01
3"	100+	\$116.68
	50/Box	\$119.30
	20,000 RPM	\$121.99
	50	\$125.35
	40	\$129.41
4"	100+	\$98.03
	25/Box	\$100.18
	20,000 RPM	\$102.44
	50	\$105.34
	40	\$108.70
	36	\$112.00



STEEL MANDRELS FOR QDC DISCS - 1/4" SHANK
 For 3/4", 1", 1-1/2" QDC Discs
ITEM# SL100MANDREL \$8.45 each
 For 2", 3", 4" QDC Discs
ITEM# SL101MANDREL \$10.60 each

ALUMINUM OXIDE

Must be used with KLINGSPOR's Holder Pads

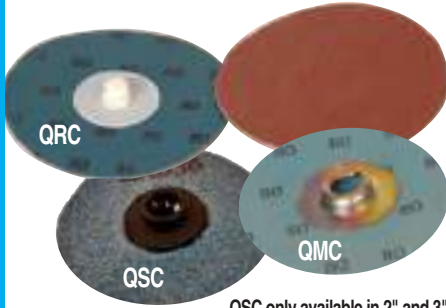

QSC only available in 2" and 3"

Diameter	Grit	Price Per Box	
1-1/2"	120	\$88.51	
	100/Box	80	\$88.51
		60	\$89.68
		50	\$92.64
		40	\$92.64
		36	\$93.53
		24	\$99.37
2"	100+	\$127.00	
	100/Box	80	\$130.00
		60	\$131.00
		50	\$197.00
		40	\$140.00
		36	\$212.00
		24	\$158.00
3"	100+	\$80.98	
	50/Box	80	\$82.84
		60	\$84.69
		50	\$87.09
		40	\$89.85
		36	\$92.60
		24	\$98.86

ALUMINA ZIRCONIA

Must be used with KLINGSPOR's Holder Pads

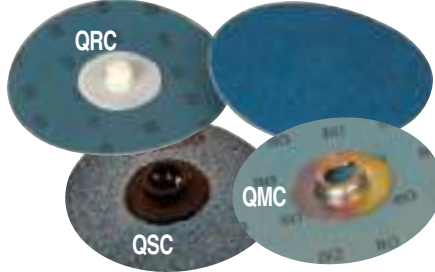

QSC only available in 2" and 3"

Diameter	Grit	Price Per Box	
1-1/2"	120	\$106.16	
	100/Box	80	\$106.16
		60	\$107.64
		50	\$111.18
		40	\$111.18
		36	\$113.53
		24	\$119.37
2"	100+	\$152.41	
	100/Box	80	\$155.53
		60	\$157.52
		50	\$163.86
		40	\$168.32
		36	\$176.86
		24	\$189.87
3"	100+	\$97.26	
	50/Box	80	\$99.40
		60	\$101.65
		50	\$104.48
		40	\$107.84
		36	\$111.08
		24	\$118.27

CERAMIC - AVAILABLE IN QDC, QRC, QMC AND QSC

QDC Must be used with KLINGSPOR's Holder Pads

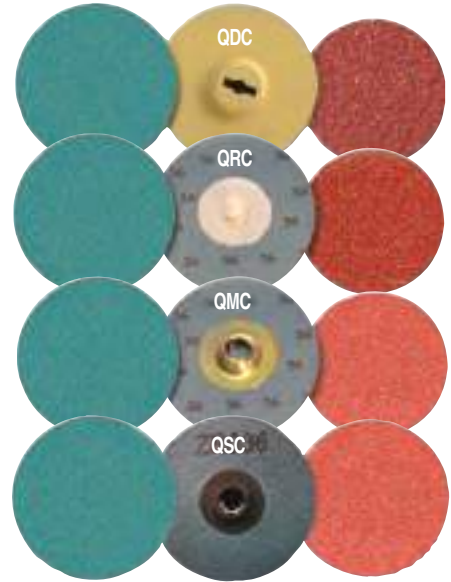

Diameter	Grit	Price Per Box	
2"	180-100	\$174.54	
	100/Box	80	\$181.61
		60	\$189.07
		50	\$196.63
		40	\$202.02
3"	180-100	\$111.63	
	50/Box	80	\$115.99
		60	\$121.57
		50	\$125.36
		40	\$129.34
	36	\$133.32	

QUICK CHANGE POWER DISCS

Made of a very coarse non-woven material, these power discs will strip paint, remove rust and scale, and other surface contaminants. Conveniently used as a KLINGSPOR QDC or a KLINGSPOR QRC for fast disc changes. Sold in boxes of 10.

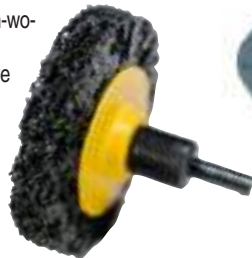

- 2" QDC Power Disc on 1-1/2" QD backer
Must be used with SL100 Mandrel
QDPD200 \$5.52/ea
- 2" QDC Power Disc on 2" QD backer
QDPD2002 \$5.47/ea
- 3" QDC Power Disc on 2" QD backer
QDPD300 \$7.24/ea
- 2" QRC Power Disc
QRCPD200 \$5.46/ea
- 3" QRC Power Disc
QRCPD300 \$7.17/ea

ALUMINA ZIRCONIA - LUBRICATED

Must be used with KLINGSPOR's Holder Pads

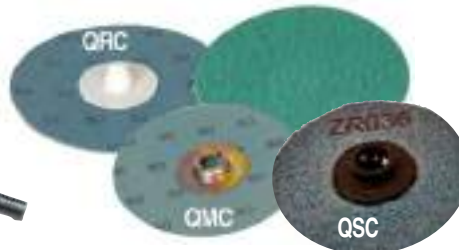

Diameter	Grit	Price Per Box	
2"	100+	\$172.53	
	100/Box	80	\$181.60
		60	\$189.07
		50	\$196.63
		40	\$202.02
3"	100+	\$110.34	
	50/Box	80	\$116.00
		60	\$121.58
		50	\$125.36
		40	\$129.40
	36	\$133.32	

CERAMIC LUBRICATED - AVAILABLE IN QDC, QRC, QMC AND QSC

QDC Must be used with KLINGSPOR's Holder Pads

Diameter	Grit	Price Per Box	
2"	80	\$181.62	
	100/Box	60	\$190.76
		50	\$196.63
		40	\$204.45
		36	\$212.23
3"	24	\$233.48	
	50/Box	80	\$115.83
		60	\$121.57
		50	\$125.34
		40	\$129.35
	36	\$133.32	
	24	\$146.64	

NOTE: MAXIMUM RPM'S FOR QRC and QMC DISCS ARE THE SAME AS THE MAXIMUM RPM RATINGS OF THE HOLDER PAD USED TO DRIVE THE DISCS.



QDC - SCRIM BACKED (NWSB)

Must be used with KLINGSPOR's Holder Pad.



Diameter	Grit	Price Per Box
2"	Very Fine	\$56.75
	Medium	\$56.75
	Coarse	\$56.75
3"	Very Fine	\$107.59
	Medium	\$107.59
	Coarse	\$107.59

QMC - SCRIM BACKED (NWSB)

Must be used with KLINGSPOR's Holder Pad.



Diameter	Grit	Price Per Box
2"	Very Fine	\$56.75
	Medium	\$56.75
	Coarse	\$56.75
3"	Very Fine	\$107.59
	Medium	\$107.59
	Coarse	\$107.59

NON-WOVEN BUFF AND BLEND (NWBB)



QRC OR QMC

Diameter	Grit	Price Per Box
2"	Very Fine	\$56.75
	Medium	\$56.75
3"	Very Fine	\$107.59
	Medium	\$107.59

QRC - SCRIM BACKED (NWSB)

Must be used with KLINGSPOR's Steel Mandrels.



Diameter	Grit	Price Per Box
2"	Very Fine	\$56.75
	Medium	\$56.75
	Coarse	\$56.75
3"	Very Fine	\$107.59
	Medium	\$107.59
	Coarse	\$107.59

HOLDER PADS FOR QRC & QMC DISCS



Disc Diameter	Density	Max RPM	QRC #	Price Per Holder
1-1/2"	Medium	25,000	(QM) (QR) HOLDER1.5MED	\$20.90
1-1/2"	Firm	30,000	(QM) (QR) HOLDER1.5FIRM	\$20.90
2"	Medium	25,000	(QM) (QR) HOLDER2.0MED	\$21.72
2"	Firm	30,000	(QM) (QR) HOLDER2.0FIRM	\$21.72
3"	Medium	20,000	(QM) (QR) HOLDER3.0MED	\$25.34
3"	Firm	20,000	(QM) (QR) HOLDER3.0FIRM	\$25.34

BRISTLE DISCS

Provide high cut while the flexible plastic brings superior cleaning to a wide variety of surface areas, without damaging the work piece. Eliminates flying wires common with traditional wire brushes.



Item#	Size	Color	Grit	Price
DYNA92015	2"	Green	50 Grit	\$18.15
DYNA92016	2"	Yellow	80 Grit	\$18.15
DYNA92017	2"	White	120 Grit	\$18.94
DYNA92021	3"	Green	50 Grit	\$27.72
DYNA92022	3"	Yellow	80 Grit	\$27.72
DYNA92023	3"	White	120 Grit	\$26.55



Non Woven

A Non-Woven is an abrasive product in the sense that there is an abrasive grain attached to a substrate via a binder resin. A 3 Dimensional web of thin nylon fibers acts as the substrate the abrasive grain is embedded in and attached to. This differs from a traditional coated abrasive where the abrasive grain is attached to the 2 Dimensional flat surface of a paper or cloth backing.

Increasing Surface Finishes with Klingspor Non-Wovens

KLINGSPOR's proven quality and service for over 130 years can be trusted for repeatable industrial performance. This exceptional uncompromising formula is synonymous with the Klingspor name and will ensure that you get The Most Sanding Power for Your Money Since 1893!

With KLINGSPOR Non-woven materials, operators will see consistent results whether the application involves cleaning, blending, deburring, or finishing. Between the toughest and the most delicate applications and finishes, KLINGSPOR Non-wovens are designed with the highest quality and your needs in mind.

Applications for Klingspor Non-woven Abrasives

Cleaning/Surface Prep

This is the initial step to begin the surface preparation for a finished product. Klingspor Non-woven materials will accomplish surface prep tasks like rust removal, paint removal, and overall enhancement of scratch patterns.

Deburring

Deburring involves removing the imperfections of shar/rough edges. Stamping processes leave metal burrs behind that require removal as a prominent process.

Blending

Creating uniform finishes, blending makes different surface qualities more equal leaving them burr-free and smooth.

Finishing/Polishing Prep

Improving the overall finish and preparing the surface for further enhancement is typically the final step with non-woven materials. KLINGSPOR non-woven materials offer repeatable, consistent finishes in most applications.

Typical Grit/Grade Comparisons

COARSE	80 – 100 GRIT
MEDIUM	150 – 180 GRIT
FINE	220 GRIT
VERY FINE	320 GRIT
SUPER FINE	600 – 800 GRIT

What is a Non-woven Abrasive?

A Non-woven abrasive is a product that is made out of a nylon fiber with grain embedded into the fibers and held together by a sprayed resin. The grains and fibers are bound together to form an open 3-dimensional web. This design makes the material "spring-like" allowing it to conform to surfaces leaving a more even finish. This differs from a traditional coated abrasive in that a traditional coated abrasive is a 2 dimensional where the grain simply sits on top of a flat surface. Non-woven abrasives in all forms, belts, discs, hand pads, and wheels offer consistency throughout meaning abrasive grains are continually exposed during work assuring surface uniformity.





Applications of Non-Woven Abrasives

- Polishing Stainless Steel
- Cleaning Aluminum Aircraft or Boat Skins
- Cleaning Food Service Equipment
- Rust or Paint Removal
- Polishing All Types of Metal Prior to Plating
- Blending Parting Lines on Castings
- Deburring Punched Sheets
- Blending Stainless Steel to #3 or #4 Finishes
- Producing Satin Finishes
- Finishing Rods and Tubing
- Preparing Metal Surfaces for Welding
- Remove Surface Scale and Oxide

Benefits of Non-Woven Abrasives

- Fast working action reduces labor costs
- Reduces loading
- Generates less heat
- Consistent finishes throughout the life of the product
- Soft action reduce likelihood of gouging or part damage
- Conformable to most workpiece shapes, as well as flat work
- Minimum break-in period
- Waterproof; Can be used dry or with water coolants.



Non-Woven Belt Speeds

- Use lower belt speeds of 3000 sfpm or less for satin finishing.
- Higher speeds up to 6500 sfpm are recommended for deburring, polishing, or oxide removal.

Klingspor Non-woven Types

Type	Availability					
NWSB						✓
NWLS	✓	✓				
NWKC	✓		✓	✓		✓
NWXF	✓		✓			✓
NWT				✓	✓	✓
NWBB						✓
NWBHD						✓
NWBHS						✓
	Short & Long Belts	Wide Belts	File Belts	Rolls	Strips/Sheets Hand Pads	Discs

Type	Application			
NWSB		✓	✓	
NWLS	✓	✓	✓	
NWKC		✓		✓
NWXF	✓	✓		✓
NWT	✓			✓
NWBB	✓	✓		✓
NWBHD	✓	✓	✓	
NWBHS	✓	✓		✓
	Cleaning	Blending	Deburring	Finishing/ Polish Prep

Surfacing Conditioning (Scrim Backed - SCM)

Surface Conditioning materials are non-wovens that are laminated to a woven backing by “needling” the nylon fibers through the scrim. This provides rigidity and support, while preventing the non-woven from stretching in belt applications.

Woven Scrim Backing

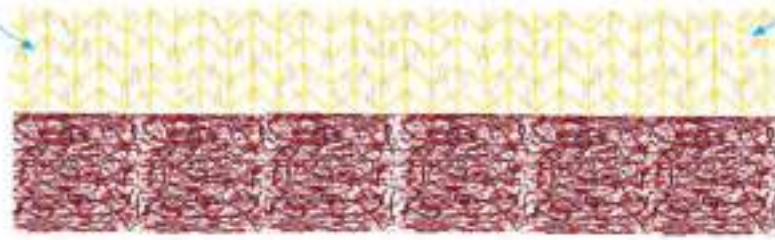

Nylon Fibers of Non-Woven material are “needled” through the woven backing to laminate the scrim and non-woven.

Nylon fibers make “loops” that give the backing a fuzzy velour.

Non-Woven abrasive on front side

GRIT	DISC		BELT	
	NWSB Disc Only	NWLS Belt Only	NWXF Belt Only	NWKC Belt Only
Coarse 80-100 Grit				
Medium 150-180 Grit				
Very Fine 320 Grit				
Super Fine 600-800 Grit				

NWSB

NWSB offers a high initial cut rate with a closed resin coating causing it to be stiff and more aggressive. That causes less conformability but more cut. This Material is good for general purpose blending, and deburring.

Available in



NWLS

Non-Woven low stretch is made with a stiff scrim backing to prevent stretching under high tension. Aggressive resin and grain coating gives the most aggression making it a good removal material. Due to the low stretch and aggressive resin and grain the belt has maximum life. The only material you can make wide belts out of.

Available in



NWXF

Non-Woven X Flex is a flexible scrim backing that is meant for tight radius contact wheels. The resin to grain ratio is enough aggression for light weld removal and deburring. So it is good for cleaning up and removing welds from metal, so a really good cleaning material.

Available in













NWKC

The Premium Non-Woven, and offers a super bright finish making it a very versatile material because it can remove a fair amount of material while also giving you a very bright finish, and then the ability for this material to be used as a belt is superior. It gives you the flexibility of our NWXF material while you are getting the removal and feeling of the NWLS material so it is very versatile.

Available in



Non-Scrim Back Materials

GRIT	NWT Rolls, Disc, Handpads	NWBB Disc Only	NWBHD Edgework Disc	NWBHS Edgework Disc
Coarse 80-100 Grit				
Medium 150-180 Grit				
Fine 220 Grit				
Very Fine 320 Grit				
Ultra Fine 600-800 Grit				

Non-Scrim Back Materials

NWT

NWT Clean and polish material is your general purpose Non-Woven it is a light resin light grain material that is used for light removal and better finishing material. It is used for cleaning and blending metal.

Available in



NWBB

Non-Woven Buff and Blend this material is used mainly for blending material like corner welds; it will not leave as bright of a finish but will hold up longer on blending applications.

Available in



NWBHD

Non-Woven High density is a dense Non-Woven meaning it has more fibers than resin which leads to a long and consistent life. It is not a heavy removal material. This is an edge work material to help clean up edges.

Available in



NWBHS

Non-Woven High Strength is a dense Non-Woven that is loaded up with resin and fibers causing it to be aggressive and remove a good amount of material. Is also an edge work material.

Available in



Non-Woven

LOW STRETCH SCRIM BACK (NWLS)

- Tight/compact non-woven fibers
- Thicker and harder resin coating
- Best for deburring (backstand)
- Slightly more aggressive for harder materials

FILE BELT SCRIM BACK (NWXF)

- Designed for file belts
- Good for belts with a tight radius

NWKC

- Mild Flexible
- Longest lasting non-woven belt
- Bright finishes
- Not overly aggressive



Material	Coarse	Medium	Very Fine	Super Fine
Color	Brown	Maroon	Blue	Grey
Grain	AO	AO	AO	SiC
Grit	80	180	320	600

FILE BELTS (NWXF ONLY)

Diameter	Price
1/2" x 18"	\$7.40
1/2" x 20-1/2"	\$7.77
1/2" x 24"	\$9.13
3/4" x 18"	\$10.33
3/4" x 20-1/2"	\$11.08
1" x 18"	\$11.02
1" x 24"	\$12.80
1-1/8" x 21"	\$12.26
1-1/4" x 20-1/2"	\$12.26
1-1/2" x 18-15/16"	\$13.01

WIDE BELTS (NWLS)

Diameter	Price
19" x 48"	\$221.00
36" x 60"	\$557.74
36" x 75"	\$672.30
37" x 60"	\$584.71
37" x 75"	\$704.97

PLATEN SANDER SIZES (NWLS)

Diameter	Price
1" x 30"	\$14.57
1" x 42"	\$18.11
1-1/2" x 60"	\$26.39
2" x 30"	\$21.97
2" x 42"	\$27.07
2" x 48"	\$29.62
2" x 60"	\$34.74
2" x 72"	\$39.84
2-1/2" x 60"	\$46.80
3" x 24"	\$27.73
3-1/2" x 15-1/2"	\$31.71
4" x 24"	\$39.10
4" x 36"	\$48.39
6" x 48"	\$80.92

BACKSTAND SANDER SIZES (NWLS)

Diameter	Price
2" x 118"	\$59.42
2" x 132"	\$65.39
3" x 118"	\$83.06
3" x 132"	\$91.14
4" x 118"	\$106.80
4" x 132"	\$122.80
4" x 168"	\$150.70

NOTE: Please add 25% for SUPERFINE pricing

Butt Joints only. Scrim back is cloth fiber velour laminated to back side of non-woven structure.

SURFACE CONDITIONING HAND PADS

6" x 9" Non-Woven Hand Pads Now in new 20 Pack

Use these hand pads as a replacement for steel wool to remove rust or to clean and polish metal surfaces.

Material#	Color	Price
4396	General Purpose	
(NWAG)	Green	\$31.28
4602	Very Fine	
(NWAV)	Maroon	\$40.76
4660	Fine	
(NWAF)	Maroon	\$35.60
4630	Ultra fine	
(NWAU)	Gray	\$40.75
4223	No Abrasive	
(NWAU)	White	\$40.75
4790	Coarse (Extra Cut)	
(NWAX)	Brown	\$79.64
4650	Medium S/C	
(NWAM)	Gray/Black	\$48.77



HAND PAD HOLDER
uses 1/2 of standard size hand pad.....\$6.41



Heavy Duty Scrim Backed Discs are available in Very Fine, Medium, and Coarse.

SCRIM BACK DISCS (NWSB*)

Must be used with long hook back up pads

Diameter	Grits	Price
4" x NH 10/Pack	Super Fine	\$39.00
	Very Fine	\$31.08
	Medium	\$31.08
	Coarse	\$31.08
4" x 5/8" 10/Pack	Super Fine	\$33.32
	Very Fine	\$26.65
	Medium	\$26.65
	Coarse	\$26.65
4-1/2" x NH 10/Pack	Super Fine	\$47.97
	Very Fine	\$38.38
	Medium	\$38.38
	Coarse	\$38.38
4-1/2" x 7/8" 10/Pack	Super Fine	\$47.97
	Very Fine	\$38.38
	Medium	\$38.38
	Coarse	\$38.38
5" x NH 10/Pack	Super Fine	\$56.73
	Very Fine	\$45.38
	Medium	\$45.38
	Coarse	\$45.38
5" x 7/8" 10/Pack	Super Fine	\$56.73
	Very Fine	\$45.38
	Medium	\$45.38
	Coarse	\$45.38
6" x NH 10/Pack	Super Fine	\$90.94
	Very Fine	\$62.87
	Medium	\$62.87
	Coarse	\$62.87
7" x NH 10/Pack	Super Fine	\$97.63
	Very Fine	\$78.10
	Medium	\$78.10
	Coarse	\$78.10
7" x 7/8" 10/Pack	Super Fine	\$97.63
	Very Fine	\$78.10
	Medium	\$78.10
	Coarse	\$78.10
8" x NH 10/Pack	Super Fine	\$134.42
	Very Fine	\$107.53
	Medium	\$107.53
	Coarse	\$107.53



CLEAN & POLISH - LIGHTWEIGHT (NWTK) KLING-ON

Diameter	Grit	Price
5" x NH 10/Pack	Very Fine	\$40.44
	Medium	40.44
	Coarse	40.44
6" x NH 10/Pack	Very Fine	\$57.52
	Medium	\$57.52
	Coarse	\$57.52
8" x NH 10/Pack	Very Fine	\$81.09
	Medium	\$81.09
	Coarse	\$81.09

BACKING PADS NON-WOVEN



For Buffers - Long Hook
Non-woven performs better at buffer rpms. Angle grinder rpms too high

Size	Item	Price
4" (5/8" - 11)	FJ40G	\$38.76
4-1/2" (5/8" - 11)	FJ45G	\$39.72
5" (5/8" - 11)	FJ50G	\$40.15
6" (5/8" - 11)	FJ60G	\$41.54
7" (5/8" - 11)	FJ70G	\$44.92
8" (5/8" - 11)	FJ80G	\$44.92

PLEASE NOTE BEFORE ORDERING:
Long Hook Pads are for use with HD Scrim Back non-woven materials

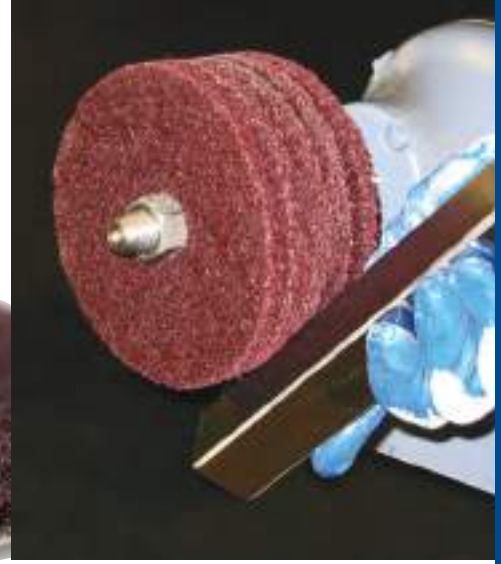

HIGH STRENGTH - FOR EDGEWORK

Medium (NWBHS + NWBHD)
Very Fine (NWBHS)

Diameter	Price
6" x 1/2" 10/Pack	\$42.60
8" x 1/2" 10/Pack	\$60.35

Other sizes available. Call for Availability.

SURFACE CONDITIONING ROLLS



CLEAN & POLISH - LIGHTWEIGHT

Diameter	Grit	Price
4" x 30 Feet	Very Fine S/C	\$78.18
	Medium A/O	\$95.99
	Coarse A/O	\$137.34
6" x 30 Feet	Very Fine S/C	\$116.60
	Medium A/O	\$143.05
	Coarse A/O	\$191.39

CONVOLUTE WHEELS

KLINGSPOR Convolute Wheels feature dense, non-woven construction. They are smooth running, non-metallic, soft and smear-resistant. They create less operator fatigue, no contamination of the workpiece, reduce gouging and provide a faster stock removal rate.

Applications: Used for blending mill marks, machine mismatches, prior sanding scratch patterns, reducing uneven edges between surfaces and surface roughness prior to welding, for removing medium burrs, light flashing, parting lines, light adhesive overflow, smoothing radii on stamped metal parts, polishing welds, blending and polishing handling marks, edge deletion on glass.

Market Usage: Chemical plants, metal fabricators, appliance manufacturers, machine builders, engine builders, welding shops, aerospace, manufacturing, maintenance, mold & die shops, welding shops, oil field machinery.

Required Tool/Equipment: Automated equipment, straight shaft stationary tools, straight shaft portable tools and feed thru machines.



Material	Description	Diameters Available*	Max RPM	Diameters			
				1/2"	1"	2"	4"
2SC	Soft Density, Multi-Finishing, Coarse Grain, SiC	6"	6,000	\$54.09	\$92.99	\$170.66	\$287.52
		8"	6,000	\$70.51	\$121.23	\$222.66	\$284.85
		12"	3,000	\$91.05	\$162.57	\$349.69	\$646.58
2SM	Soft Density, Multi-Finishing, Medium Grain, SiC	6"	6,000	\$54.29	\$93.27	\$171.27	\$216.23
		8"	6,000	\$68.82	\$118.25	\$217.12	\$342.68
5AM	Medium-Soft Density, Metal Finishing, Medium Grain, AO	6"	6,000	\$78.81	\$135.61	\$249.26	\$407.76
		8"	6,000	\$86.11	\$148.17	\$272.30	\$479.72
		12"	3,000	\$150.83	\$251.93	\$416.15	\$910.93
7SF	Medium Density, Deburring, Fine Grain, SiC	6"	6,000	\$78.81	\$135.61	\$249.26	\$384.50
		8"	6,000	\$86.11	\$148.17	\$272.29	\$435.24
		12"	3,000	\$106.55	\$254.38	\$416.15	\$711.47
		14"	2,550	\$145.80	\$284.91	\$463.77	\$888.85
8AM	Medium-Hard Density, Deburring, Medium Grain, AO	6"	6,000	\$76.00	\$130.84	\$240.56	\$417.91
		8"	6,000	\$89.65	\$154.30	\$283.57	\$524.41
8SM	Medium-Hard Density, Deburring, Medium Grain, SiC	6"	6,000	\$76.00	\$130.85	\$240.55	\$441.22
		8"	6,000	\$89.64	\$154.30	\$283.57	\$486.78
		12"	3,000	\$150.83	\$254.39	\$407.91	\$823.15
8SF	Medium-Hard Density, Deburring, Fine Grain, SiC	6"	6,000	\$76.00	\$130.85	\$240.55	\$441.22
		8"	6,000	\$89.64	\$154.30	\$283.57	\$501.36
		12"	3,000	\$135.98	\$254.39	\$430.48	\$823.15
8SF-R	Medium-Hard Density, Rigid, Deburring, Fine Grain, SiC	6"	6,000	\$76.00	\$130.85	\$240.55	\$435.09
		8"	6,000	\$89.64	\$154.30	\$283.57	\$503.00
		12"	3,000	\$139.95	\$254.39	\$432.81	\$823.15
9SF	Hard Density, Deburring, Fine Grain, SiC	6"	6,000	\$76.00	\$130.85	\$240.55	\$471.36
		8"	6,000	\$89.64	\$154.30	\$283.57	\$565.05
		12"	3,000	\$150.83	\$254.39	\$432.80	\$862.85
9SF-R	Hard Density, Rigid, Deburring, Fine Grain, SiC	6"	6,000	\$76.00	\$130.85	\$240.55	\$484.48
		8"	6,000	\$89.64	\$154.30	\$283.57	\$571.17
		10"	3,600	\$101.76	\$204.45	\$354.47	\$615.41
10SF	Extra-Hard Density, Deburring, Fine Grain, SiC	12"	3,000	\$106.54	\$254.38	\$432.80	\$910.93

* All 6" diameter wheels have 1" arbor holes, 8" diameter wheels have 3" arbor holes, & 12" diameter wheels have 5" arbor holes.

** Custom widths can be cut from stock logs.

Part Number Example:

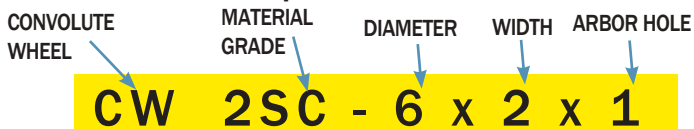

IMPORTANT: Convolute wheels must be run in the direction of the arrow.

Mounting Bushings - 2 Per Box

Description	Item#	Net Price
6" Wheel Bushing 1" to 3/8"	611BUSH1X3/8	\$3.08
6" Wheel Bushing 1" to 1/2"	611BUSH1X1/2	\$3.08
6" Wheel Bushing 1" to 3/4"	611BUSH1X3/4	\$3.08
6" Wheel Bushing 1" to 5/8"	611BUSH1X5/8	\$4.70
8" Wheel Bushing 3" to 1"	CFVB004	\$116.91
8" Wheel Bushing 3" to 1-1/4"	CFVB005	\$116.91
10" & 12" Wheel Bushing 5" to 1"	CFVB006	\$246.91
10" & 12" Wheel Bushing 5" to 1-1/4"	CFVB007	\$246.90





Unitized Wheels are used for general purpose metal cleaning, deburring, and polishing. They are produced by compressing non-woven abrasive web creating a durable and versatile product.

- Perfect for cleaning prior to painting, removing rust, discoloration from welds, minor pits and scratches, resins/adhesives overspray and coating.
- Deburrs and finishes with minimal change to workpiece shape
- Resists smearing for cleaner surfaces and less preparation
- Open web resists loading
- Available in a variety of densities and grades for applications requiring flexible or aggressive cutting action



1/8" THICK	1/4" THICK	1/2" THICK	1" THICK
2SF – Low Density, Fine Grit SiC	2AM – Low Density, Medium Grit AO	2AM – Low Density, Medium Grit AO	2AM – Low Density, Medium Grit AO
4AF – Medium Density, Fine Grit AO	2SF – Low Density, Fine Grit SiC	2SF – Low Density, Fine Grit SiC	4SF – Medium Density, Fine Grit SiC
4AM – Medium Density, Medium Grit AO	3SF – Med/Low Density, Fine Grit SiC	3SF – Med/Low Density, Fine Grit SiC	8AM – High Density, Medium Grit AO
6AM – Med/High Density, Medium Grit AO	4AF – Medium Density, Fine Grit AO	4AF – Medium Density, Fine Grit AO	
	4SF – Medium Density, Fine Grit SiC	4SF – Medium Density, Fine Grit SiC	
	6AF – Med/High Density, Fine Grit SiC	6SF – Med/High Density, Fine Grit SiC	
	6SF – Med/High Density, Fine Grit SiC	6AF – Med/High Density, Fine Grit AO	
	8AM – High Density, Medium Grit AO	8AC – High Density, Coarse Grit AO	
	9AC – High Density, Coarse Grit AO	8AM – High Density, Medium Grit AO	

*Optimum RPM may be below Maximum RPM to produce the desired finish, and can be run as low as 3,200rpm.
 Dynabrade Die Grinders: DYNA47201, DYNA47211, DYNA52101, DYNA52662, DYNA46000, DYNA47800, & DYNA48315



DIE GRINDER WHEEL OPTIONS: 1/4" THICK

ARBOR1/2X1/4FH\$0.17 (Item# for arbor shown)

Size	Item #	Price Each	Size	Item #	Price Each	Size	Item #	Price Each
2" X 1/4" X 1/2"	UW2AM2X.25X.5	\$11.17	3" X 1/4" X 1/2"	UW2AM3X.25X.5	\$13.89	4" X 1/4" X 1/2"	UW2AM4X.25X.5	\$31.85
Max Safe Speed	UW2SF2X.25X.5	\$11.17	Max Safe Speed	UW2SF3X.25X.5	\$13.89	Max Safe Speed	UW2SF4X.25X.5	\$31.85
25,000 RPM	UW3SF2X.25X.5	\$11.17	20,000 RPM	UW3SF3X.25X.5	\$13.89	20,000 RPM	UW3SF4X.25X.5	\$31.85
Optimum Performance	UW4AF2X.25X.5	\$11.17	Optimum Performance	UW4AF3X.25X.5	\$13.89	Optimum Performance	UW4AF4X.25X.5	\$31.85
Speed 18,000 RPM	UW4SF2X.25X.5	\$11.17	Speed 12,000 RPM	UW4SF3X.25X.5	\$13.89	Speed 12,000 RPM	UW4SF4X.25X.5	\$31.85
10 Per Box	UW6AF2X.25X.5	\$11.17	10 Per Box	UW6AF3X.25X.5	\$13.89	10 Per Box	UW6AF4X.25X.5	\$31.85
	UW6SF2X.25X.5	\$11.17		UW6SF3X.25X.5	\$13.89		UW6SF4X.25X.5	\$31.85
	UW8AM2X.25X.5	\$11.17		UW8AM3X.25X.5	\$13.89		UW8AM4X.25X.5	\$31.85
	UW9AC2X.25X.5	\$11.17		UW9AC3X.25X.5	\$13.89		UW9AC4X.25X.5	\$31.85



ARBOR1/4-3/8X1/4SL\$0.51 (Item# for arbor shown)

Size	Item #	Price Each	Size	Item #	Price Each	Size	Item #	Price Each
2" X 1/4" X 1/4"	UW2AM2X.25X.25	\$11.17	3" X 1/4" X 1/4"	UW2AM3X.25X.25	\$13.89	4" X 1/4" X 1/4"	UW2AM4X.25X.25	\$31.85
Max Safe Speed	UW2SF2X.25X.25	\$11.17	Max Safe Speed	UW2SF3X.25X.25	\$13.89	Max Safe Speed	UW2SF4X.25X.25	\$31.85
25,000 RPM	UW3SF2X.25X.25	\$11.17	20,000 RPM	UW3SF3X.25X.25	\$13.89	20,000 RPM	UW3SF4X.25X.25	\$31.85
Optimum Performance	UW4AF2X.25X.25	\$11.17	Optimum Performance	UW4AF3X.25X.25	\$13.89	Optimum Performance	UW4AF4X.25X.25	\$31.85
Speed 18,000 RPM	UW4SF2X.25X.25	\$11.17	Speed 12,000 RPM	UW4SF3X.25X.25	\$13.89	Speed 12,000 RPM	UW4SF4X.25X.25	\$31.85
10 Per Box	UW6AF2X.25X.25	\$11.17	10 Per Box	UW6AF3X.25X.25	\$13.89	10 Per Box	UW6AF4X.25X.25	\$31.85
	UW6SF2X.25X.25	\$11.17		UW6SF3X.25X.25	\$13.89		UW6SF4X.25X.25	\$31.85
	UW8AM2X.25X.25	\$11.17		UW8AM3X.25X.25	\$13.89		UW8AM4X.25X.25	\$31.85
	UW9AC2X.25X.25	\$11.17		UW9AC3X.25X.25	\$13.89		UW9AC4X.25X.25	\$31.85

TYPE 27 ANGLE GRINDER DISC OPTIONS

Size	Item #	Price	Size	Item #	Price
4-1/2" X 7/8"	UWSA6-4.5X.875	\$39.30	4-1/2" X 5/8"-11	UWSA6-4.5X.875A	\$41.32
Max RPM 12,200	UWMA8-4.5X.875	\$39.30	Max RPM 12,200	UWMA8-4.5X.875A	\$41.32





DIE GRINDER WHEEL OPTIONS: 1/2" THICK

Arbor1/4x1/4NL\$6.74 (Item# for arbor shown)

Size	Item #	Price Each	Size	Item #	Price Each	Size	Item #	Price Each
2" X 1/2" X 1/4" Max Safe Speed 25,000 RPM Optimum Performance Speed 18,000 RPM 10 Per Box	UW2AM2X.5X.25	\$16.60	3" X 1/2" X 1/4" Max Safe Speed 20,000 RPM Optimum Performance Speed 12,000 RPM 10 Per Box	UW2AM3X.5X.25	\$22.36	4" X 1/2" X 1/4" Max Safe Speed 20,000 RPM Optimum Performance Speed 12,000 RPM 10 Per Box	UW2AM4X.5X.25	\$37.25
	UW2SF2X.5X.25	\$16.60		UW2SF3X.5X.25	\$22.36		UW2SF4X.5X.25	\$37.25
	UW3SF2X.5X.25	\$16.60		UW3SF3X.5X.25	\$22.36		UW3SF4X.5X.25	\$37.25
	UW4AF2X.5X.25	\$16.60		UW4AF3X.5X.25	\$22.36		UW4AF4X.5X.25	\$37.25
	UW4SF2X.5X.25	\$16.60		UW4SF3X.5X.25	\$22.36		UW4SF4X.5X.25	\$37.25
	UW6AF2X.5X.25	\$16.60		UW6AF3X.5X.25	\$22.36		UW6AF4X.5X.25	\$37.25
	UW6SF2X.5X.25	\$16.60		UW6SF3X.5X.25	\$22.36		UW6SF4X.5X.25	\$37.25
	UW8AC2X.5X.25	\$16.60		UW8AC3X.5X.25	\$22.36		UW8AC4X.5X.25	\$37.25
UW8AM2X.5X.25	\$16.60	UW8AM3X.5X.25	\$22.36	UW8AM4X.5X.25	\$37.25			

QUICK CHANGE WHEELS – QRC'S AND QDC'S

Size	Item #	Price Each	Size	Item #	Price Each	Size	Item #	Price Each
1" X 1/4" Max Safe Speed 30,000 RPM Optimum Performance Speed 18,000 RPM 10 Per Box	QDCUD2AM100	\$9.18	1-1/2" X 1/4" Max Safe Speed 25,000 RPM Optimum Performance Speed 18,000 RPM 10 Per Box	(QR)(QD)CUD2AM150	\$9.82	2" X 1/4" Max Safe Speed 25,000 RPM Optimum Performance Speed 18,000 RPM 10 Per Box	(QR)(QD)CUD2AM200	\$10.76
	QDCUD2SF100	\$9.18		(QR)(QD)CUD2SF150	\$9.82		(QR)(QD)CUD2SF200	\$10.76
	QDCUD3SF100	\$9.18		(QR)(QD)CUD3SF150	\$9.82		(QR)(QD)CUD3SF200	\$10.76
	QDCUD4AF100	\$9.18		(QR)(QD)CUD4AF150	\$9.82		(QR)(QD)CUD4AF200	\$10.76
	QDCUD4SF100	\$9.18		(QR)(QD)CUD4SF150	\$9.82		(QR)(QD)CUD4SF200	\$10.76
	QDCUD6AF100	\$9.18		(QR)(QD)CUD6AF150	\$9.82		(QR)(QD)CUD6AF200	\$10.76
	QDCUD6SF100	\$9.18		(QR)(QD)CUD6SF150	\$9.82		(QR)(QD)CUD6SF200	\$10.76
	QDCUD8AM100	\$9.18		(QR)(QD)CUD8AM150	\$9.82		(QR)(QD)CUD8AM200	\$10.76
QDCUD9AC100	\$9.18	(QR)(QD)CUD9AC150	\$9.82	(QR)(QD)CUD9AC200	\$10.76			



Size	Item #	Price Each	Size	Item #	Price Each
3" X 1/4" Max Safe Speed 20,000 RPM Optimum Performance Speed 12,000 RPM 10 Per Box	(QR)(QD)CUD2AM300	\$13.29	4" X 1/4" Max Safe Speed 20,000 RPM Optimum Performance Speed 12,000 RPM 10 Per Box	(QR)(QD)CUD2AM400	\$30.39
	(QR)(QD)CUD2SF300	\$13.29		(QR)(QD)CUD2SF400	\$30.39
	(QR)(QD)CUD3SF300	\$13.29		(QR)(QD)CUD3SF400	\$30.39
	(QR)(QD)CUD4AF300	\$13.29		(QR)(QD)CUD4AF400	\$30.39
	(QR)(QD)CUD4SF300	\$13.29		(QR)(QD)CUD4SF400	\$30.39
	(QR)(QD)CUD6AF300	\$13.29		(QR)(QD)CUD6AF400	\$30.39
	(QR)(QD)CUD6SF300	\$13.29		(QR)(QD)CUD6SF400	\$30.39
	(QR)(QD)CUD8AM300	\$13.29		(QR)(QD)CUD8AM400	\$30.39
	(QR)(QD)CUD9AC300	\$30.39		(QR)(QD)CUD9AC400	\$30.39

FILE WELD GRINDER OPTIONS – 1/4" THICK

Size	Item #	Price	Size	Item #	Price	Size	Item #	Price
6" X 1/4" X 1/2" Max RPM 6,000	UW2AM6X.25X.5	\$43.65	6" X 1/4" X 5/8" Max RPM 6,000	UW2AM6X.25X.625	\$43.65	6" X 1/4" X 7/8" Max RPM 6,000	UW2AM6X.25X.875	\$43.65
	UW2SF6X.25X.5	\$43.65		UW2SF6X.25X.625	\$43.65		UW2SF6X.25X.875	\$43.65
	UW3SF6X.25X.5	\$43.65		UW3SF6X.25X.625	\$43.65		UW3SF6X.25X.875	\$43.65
	UW4AF6X.25X.5	\$43.65		UW4AF6X.25X.625	\$43.65		UW4AF6X.25X.875	\$43.65
	UW4SF6X.25X.5	\$43.65		UW4SF6X.25X.625	\$43.65		UW4SF6X.25X.875	\$43.65
	UW6AF6X.25X.5	\$43.65		UW6AF6X.25X.625	\$43.65		UW6AF6X.25X.875	\$43.65
	UW6SF6X.25X.5	\$43.65		UW6SF6X.25X.625	\$43.65		UW6SF6X.25X.875	\$43.65
	UW8AM6X.25X.5	\$43.65		UW8AM6X.25X.625	\$43.65		UW8AM6X.25X.875	\$43.65
	UW9AC6X.25X.5	\$43.65		UW9AC6X.25X.625	\$43.65		UW9AC6X.25X.875	\$43.65

FILE WELD GRINDER WHEEL OPTIONS – 1/8" THICK

Size	Item #	Price	Size	Item #	Price	Size	Item #	Price
6" x 1/8" x 5/8" Max RPM 6,000	UW2SF6X.125X.625	\$27.54	6" x 1/8" x 7/8" Max RPM 6,000	UW2SF6X.125X.875	\$27.54	6" x 1/8" x 1" Max RPM 6,000	UW2SF6X.125X1	\$27.54
	UW4AF6X.125X.625	\$27.54		UW4AF6X.125X.875	\$27.54		UW4AF6X.125X1	\$27.54
	UW4AM6X.125X.625	\$27.54		UW4AM6X.125X.875	\$27.54		UW4AM6X.125X1	\$27.54
	UW6AF6X.125X.625	\$27.54		UW6AF6X.125X.875	\$27.54		UW6AF6X.125X1	\$27.54
	UW6AM6X.125X.625	\$27.54		UW6AM6X.125X.875	\$27.54		UW6AM6X.125X1	\$27.54



LS 309: Aluminum Oxide, fully resin bonded, J or J-flex cotton cloth for polishing ferrous or non-ferrous metals and hardwoods where belt conformability to the work piece is required. Narrow belts and some intermediate belts. XH backing is for portable belts only.

CS 310: Aluminum Oxide, X or X-Flex cloth resin-resin bond, closed coat. Suitable for all ferrous metals, hardwoods, leather, aluminum, stainless steel, and most alloys.

CS 411 X: ****** Alumina Zirconia resin-bonded, with X-weight cloth backing for high pressure, heavy stock removal on all types of metal, especially carbon and tool steels. Polyester backings can be used wet or dry.

**** Add 30% to final price**

CS 412 Y: **Y** Aluminum Oxide, resin bonded, Y-weight, polyester-backings for use wet or dry on ferrous or non-ferrous metals. Also suitable for sanding hardwoods.

***Add 5% to final price**



Cross Pads

Square Pads



SQUARE PADS

Size	Grits	Max RPM	Price Per Each
1" x 1" x 8 ply 8-32 eyelet	60,80,120	25,000	\$2.50
1-1/2" x 1-1/2" x 1/2" 1/4-20 eyelet	60,80	25,000	\$4.60
2" x 2" x 1/2" 1/4-20 eyelet	60,80	20,000	\$6.19
2" x 2" x 3/4" 1/4-20 eyelet	50,80	20,000	\$6.19
3" x 3" x 1/4" 1/4-20 eyelet	80	14,000	\$6.79
3" x 3" x 1/2" 1/4-20 eyelet	50,60,80	14,000	\$6.79

CROSS PADS

Size	Grits	Max RPMs	Price Per Each
1-1/2" x 1-1/2" x 1/2" 8 ply 8-32 eyelet	60,80,100,120	25,000	\$2.45
2" x 2" x 1/2" 8 ply 8-32 eyelet	60,80,120	20,000	\$2.46
2" x 2" x 3/4" 8 ply 8-32 eyelet	60,80,120	20,000	\$2.46
2" x 2" x 1" 8 ply 8-32 eyelet	120	20,000	\$2.47
2-1/4" x 2-1/4" x 1/2" 8 ply 8-32 eyelet	80	20,000	\$2.75
2-1/2" x 2-1/2" x 3/4" 8 ply 8-32 eyelet	80,120	20,000	\$2.91
3" x 3" x 1" 8 ply 1/4-20 eyelet	60,80,120	14,000	\$3.30
4" x 4" x 1" 8 ply 1/4-20 eyelet	60,80,120	14,000	\$4.35
4" x 4" x 1-1/2" 8 ply 1/4-20 eyelet	80,120	14,000	\$4.35

CROSS PAD & BUFF MANDRELS

6" x 1/4" x 8-32	
CBMANDREL6X1/4X8-32	\$19.96
8" x 1/4" x 8-32	
CBMANDREL8X1/4X8-32	\$22.15
6" x 1/4" x 1/4"-20	
CPMANDREL6X1/4-20	\$15.81
2.92" x 1/4" x 8-32	
CPMANDREL2.92-1/4X8-32	\$9.25
3" x 1/4" x 1/4"-20	
CPMANDREL3-1/4-20	\$13.58

CROSS BUFFS NON-WOVEN ONLY

Item#	Size	Max RPMs	Price Per Each
	1" x 1" x 2 ply w/ 8-32 threaded eyelet	20,000	\$4.18
	1" x 1" x 3 ply w/ 8-32 threaded eyelet	20,000	\$4.18
	1-1/2" x 1-1/2" x 2 ply w/ 8-32 threaded eyelet	20,000	\$3.45
	1-1/2" x 1-1/2" x 3 ply w/ 8-32 threaded eyelet	20,000	\$4.63

Use same mandrels as Cross Pads



SPONGE BOX SQUARE PADS - For Dry Use Only

Sponge Box Square Pads are available in 2 material types: VP 73W aluminum oxide stearate and PS 35 silicon carbide stearate. Both are applied to a pliable, yet durable foam roll. This spongy foam roll has been perforated for a quick dispersion of the 4-1/2 X 5-1/2 square pads. Sponge box square pads are ideal for every finishing department.

Size	Grit	Item #	Price Per Box	Size	Grit	Item #	Price Per Box
4.5" X 5.5	073 0180W	SPONGEBOX180	\$98.09	4.5" X 5.5	035 0220W	SPONGEBOXPS35220	\$82.76
130/RL	073 0220W	SPONGEBOX220	\$98.09	130/RL	035 0320W	SPONGEBOXPS35320	\$82.76
	073 0240W	SPONGEBOX240	\$98.09		035 0400W	SPONGEBOXPS35400	\$82.76
	073 0320W	SPONGEBOX320	\$98.09				
	073 0400W	SPONGEBOX400	\$98.09				
	073 0600W	SPONGEBOX600	\$98.09				
	073 0800W	SPONGEBOX800	\$95.06				



FUSION FOAM

Fusion Foam is uniquely engineered, eco-friendly, flexible, and non-loading. The adhesive system locks our abrasive grain in place while providing exceptionally long life over competitive products.

- The high quality silicon carbide, as well as both brown and white aluminum oxide abrasive grains are applied directly to the foam surface.
- Resists loading due to Proprietary grain to foam adhesion, which reduces heat build-up.
- Designed and engineered to obtain an even, uniform surface on contoured or flat surfaces.
- Because of the special coating of the foam, the flexibility of the disc requires no costly, time-consuming interface pads.
- Fusion Foam may be used either wet or dry.
- Fusion Foam Discs attach quickly and easily by way of a special velour backing and releases just as quickly from your hook & loop ready backing pad.



FUSION PADS

Size	Grit	Price Per Pad
3" x4-1/4" x1/2"*	600-700	\$2.12
	5/Box	280-380 \$2.12
		220-320 \$2.12
		120-150 \$2.12
		1800-2500 \$2.12
3" x4-1/4" x5mm*	5/Box	1200-1500 \$2.16
		800-1200 \$2.12
		600-700 \$2.12
		280-380 \$2.12
		220-320 \$2.12
	120-150 \$2.12	

10 MM FUSION FOAM

KLINGSPOR's new 10 MM thick Fusion Foam has the capability to scuff and sand both flat and contoured surfaces without leaving deep scratches. Curved and sloped surfaces as well as cabinet door profiles and raised panels are all perfect applications for this product. Also great for turned workpieces. Sizes will be set up as needed.

Size	Grit	Price Per Pad
3" x4-1/4" x10mm*	1000 SC	\$2.96
	5/Box	600-700 AO \$2.96
		280-380 AO \$2.96
		220-320 AO \$2.96
		120-150 AO \$2.96

FUSION DISCS

Diameter	Grit	Price Per Disc
3"	2800-3500	\$4.02
	5/Box	1800-2500 \$4.02
		1200-1500 \$4.02
		800-1200 \$4.02
		2800-3500 \$6.98
5"	5/Box	1800-2500 \$6.98
		1200-1500 \$6.98
		800-1200 \$6.98
		600-700 \$4.45
		220-320 \$4.45
	120-150 \$4.45	
6"	2800-3500	\$8.89
	5/Box	1800-2500 \$8.89
		1200-1500 \$8.89
		800-1200 \$8.89
		600-700 \$5.74
	220-320 \$5.74	
	120-150 \$5.74	

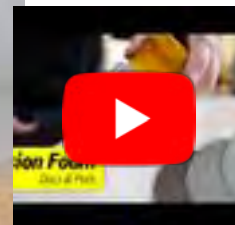

SCAN HERE TO LEARN MORE ABOUT

FUSION FOAM



FOAM SANDING PADS - For Dry Use Only

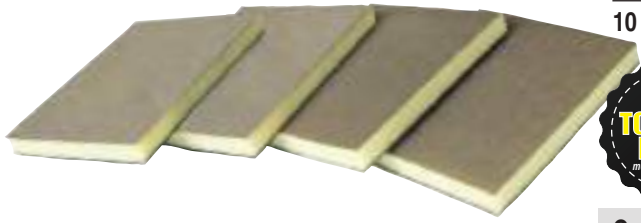

Unit	SC Item #	AO Item #	Grit	Price Per Pack
10 Pack	FS220SC-10	FS220AO-10	220	\$23.22
	FS180SC-10	FS180AO-10	180	\$23.22
	FS120SC-10	FS120AO-10	120	\$23.22
	FS100SC-10	FS100AO-10	100	\$23.22
	FS080SC-10	FS080AO-10	80	\$23.22
	FS060SC-10	FS060AO-10	60	\$23.22
Case (250)	FOAMSAND220SC	FOAMSANDING220	220	\$522.46
	FOAMSAND180SC	FOAMSANDING180	180	\$522.46
	FOAMSAND120SC	FOAMSANDING120	120	\$522.46
	FOAMSAND100SC	FOAMSANDING100	100	\$522.46
	FOAMSAND080SC	FOAMSANDING080	80	\$522.46
	FOAMSAND060SC	FOAMSANDING060	60	\$522.46

The Foam Sanding Pad can be used on severely profiled parts, because it is more flexible and much thinner. The foam pad measures 3.5" x 4.5" and 1/2" thick. KLINGSPOR Foam Sanding Sponges are now produced with the latest technological advances. These general purpose foam pads are solvent free and outperform other similar pads on the market. **Best used with light pressure.**



ULTRA FLEX SANDING PADS - For Wet / Dry Use

The UltraFlex Sanding Pads are the premium foam pads on the market. These incorporate a dense foam structure and a full, even coating of either ALUMINUM OXIDE or SILICON CARBIDE grains. This makes for an extremely long-lasting pad that is very flexible for finish-sanding of contoured parts and profiles. The pad measures 4-1/2" wide and 5-1/2" long. **Best used with light pressure.**

Unit	SC Item #	AO Item #	Grit	Price Per Pack
10 Pack	UF320SC-10	UF320AO-10	320	\$23.22
	UF220SC-10	UF220AO-10	220	\$23.22
	UF180SC-10	UF180AO-10	180	\$23.22
	UF120SC-10	UF120AO-10	120	\$23.22
		UF100AO-10	100	\$23.22

SANDING SPONGES - For Dry Use Only

Our Sanding Sponge* is meant for the sanding of slight contours and flat parts. It measures approximately 4" in length, 3" in width and 1-1/4" thick. **Best used with light pressure.**



* Sponges are available in Aluminum Oxide only.

Unit	Item #	Grit	Price Per Pack	Unit	Item #	Grit	Price Per Pack
10 Pack	SS220-10	220	\$23.22	Case (250)	SANDINGSPONG220	220	\$522.46
	SS180-10	180	\$23.22		SANDINGSPONG180	180	\$522.46
	SS120-10	120	\$23.22		SANDINGSPONG120	120	\$522.46
	SS100-10	100	\$23.22		SANDINGSPONG100	100	\$522.46
	SS080-10	80	\$23.22		SANDINGSPONG080	80	\$522.46
	SS060-10	60	\$23.22		SANDINGSPONG060	60	\$522.46

ANGLED SANDING SPONGES - For Dry Use Only

Our Sanding Sponge is meant for the sanding of slight contours and flat parts. It measures approximately 4" in length, 3" in width and 1-1/4" thick. **Best used with light pressure.**



* Sponges are available in Aluminum Oxide only.

Unit	Item #	Grit	Price Per Pack	Unit	Item #	Grit	Price Per Pack
10 Pack	SS220SA-10	220	\$29.11	Case (250)	SANDINGSPONG220SA	220	\$662.57
	SS180SA-10	180	\$29.11		SANDINGSPONG180SA	180	\$662.57
	SS120SA-10	120	\$29.11		SANDINGSPONG120SA	120	\$662.57
	SS100SA-10	100	\$29.11		SANDINGSPONG100SA	100	\$662.57
	SS060SA-10	60	\$29.11		SANDINGSPONG060SA	60	\$662.57

Klingspor's Mounted Points have been developed for safe, high performance use. Quality is consistently excellent, as you would expect from products with the Klingspor name. Over 100 different shapes and a variety of sizes, bonds, grits, etc. are available to suit virtually any metal grinding need.

All Mounted Points must be purchased in quantities of 10

GROUP "A" SPECIAL SHAPES - 1/4" SHANKS

Shape	Dia x Length	Max RPM	Red	Blue	Price Per Pack of 10
A1	3/4" x 2-1/4"	19,800	60	60	\$91.58
A2	1" x 1-1/4"	38,200	60	60	\$57.62
A3	1" x 2-3/4"	16,100	60	60	\$99.30
A4	1-1/4" x 1-1/4"	30,560	60	60	\$62.25
A5	3/4" x 1-1/8"	45,000	60	60	\$53.41
A11	7/8" x 2"	19,860	60	60	\$67.50
A11	7/8" x 2"	19,860	36	36	\$67.50
A12	1-1/16" x 1-1/4"	48,000	60	60	\$61.53
A14	1-1/16" x 7/8"	55,560	60	■	\$38.79
A15	1/4" x 1-1/16"	72,750	60	60	\$51.55
A21	1" x 1"	34,500	60	60	\$43.73
A24	1/4" x 3/4"	76,500	60	60	\$36.84
A25	1" x 1"	35,620	60	60	\$44.56
A26	5/8" x 5/8"	61,120	60	60	\$39.72
A31	1-3/8" x 1"	27,780	60	60	\$53.41
A32	1" x 5/8"	38,000	60	60	\$38.79
A34	1-1/2" x 3/8"	25,470	60	60	\$41.98
A36	1-5/8" x 3/8"	23,520	60	60	\$51.86
A37	1-1/4" x 1/4"	30,560	60	60	\$38.79
A38	1" x 1"	34,500	60	60	\$36.84
A39	3/4" x 3/4"	47,250	60	60	\$31.59

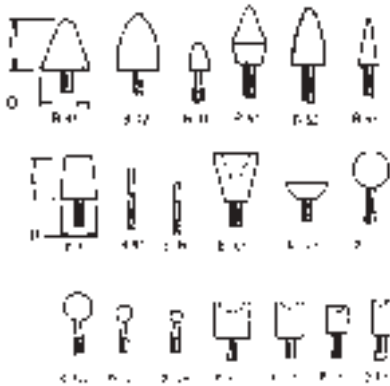
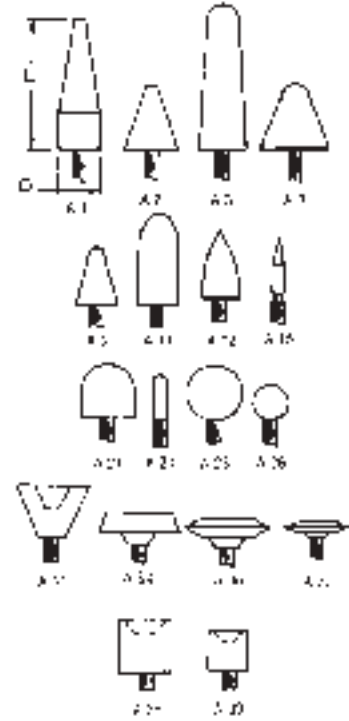

GROUP "B" SPECIAL SHAPES - 1/8" SHANKS

Shape	Dia x Length	Max RPM	Red	Blue	Price Per Pack of 10
B41	5/8" x 5/8"	33,750	60	60	\$37.87
B42	1/2" x 3/4"	33,750	60	60	\$36.22
B44	7/32" x 3/8"	68,400	60	60	\$34.68
B44	7/32" x 3/8"	68,400	90	90	\$34.68
B51	7/16" x 3/4"	45,370	60	60	\$30.56
B52	3/8" x 3/4"	45,370	60	60	\$36.84
B53	1/4" x 5/8"	60,000	60	60	\$36.84
B91	1/2" x 5/8"	34,500	60	60	\$36.84
B96	1/8" x 1/4"	105,000	90	90	\$66.47
B97	1/8" x 3/8"	105,000	90	90	\$33.03
B97	1/8" x 3/8"	105,000	120	120	\$33.03
B98	3/32" x 1/4"	105,000	90	90	\$37.87
B101	5/8" x 11/16"	33,750	60	60	\$35.81
B103	5/8" x 3/16"	61,120	60	60	\$35.09
B121	1/2" x 1/2"	45,370	60	60	\$36.53
B122	3/8" x 3/8"	61,650	60	60	\$34.57
B123	3/16" x 3/16"	104,250	90	90	\$27.17
B124	1/8" x 1/8"	105,000	90	90	\$29.42
B131	1/2" x 1/2"	34,500	60	60	\$27.17
B132	3/8" x 1/2"	45,370	60	60	\$27.17
B134	5/16" x 3/8"	61,650	60	60	\$26.45
B135	1/4" x 1/2"	60,000	60	60	\$27.17



**While all Mounted Points listed are available, not all are in-stock items. Be sure to inquire about availability.



GROUP "W" PLAIN SHAPES

**While all Mounted Points listed are available, not all are in-stock items. Be sure to inquire about availability.



Shape	Diameter x Length	Shank Size	Max RPM	Red	Blue	Price Per Pack of 10
W142	3/32" x 1/4"	1/8"	105,000	120	120	\$23.67
W144	3/32" x 1/4"	1/8"	105,000	120	60	\$24.80
W145	1/8" x 3/8"	1/8"	105,000	60	60	\$26.45
W146	1/8" x 1/2"	1/8"	105,000	60	60	\$24.39
W152	3/16" x 1/4"	1/8"	105,000	60	60	\$25.42
W153	3/16" x 3/8"	1/8"	80,850	60	60	\$26.45
W154	3/16" x 1/2"	1/8"	70,500	60	60	\$26.45
W160	1/4" x 1/4"	1/8"	81,370	60	60	\$25.42
W162	1/4" x 3/8"	1/8"	68,400	60	60	\$26.45
W163	1/4" x 1/2"	1/8"	60,000	60	60	\$27.17
W164	1/4" x 3/4"	1/8"	45,900	60	60	\$28.71
W175	3/8" x 3/8"	1/8"	54,000	60	60	\$27.99
W176	3/8" x 1/2"	1/8"	45,370	60	60	\$26.45
W178	3/8" x 1"	1/8"	26,250	60	60	\$30.87
W179	3/8" x 1-1/4"	1/8"	45,750+	60	60	\$40.00
W185	1/2" x 1/2"	1/4"	34,500	60	60	\$24.39
W186	1/2" x 1"	1/8"	20,620	60	60	\$30.87
W187	1/2" x 1-1/2"	1/8"	30,370+	60	60	\$46.41
W188	1/2" x 2"	1/4"	24,000+	60	60	\$58.45
W189	3/4" x 3/4"	1/4"	18,900+	60	60	\$30.87
W204	3/4" x 1"	1/4"	34,900+	60	60	\$38.79
W205	3/4" x 1-1/4"	1/4"	28,720	60	60	\$39.93
W206	1" x 1/8"	1/4"	38,200	60	60	\$29.43
W215	1" x 1/2"	1/8"	38,200+	60	60	\$30.87
W218	1" x 1"	1/4"	25,500+	60	60	\$36.84
W220	1" x 1-1/2"	1/4"	19,120+	60	60	\$51.04
W221	1" x 2"	1/4"	15,900+	60	60	\$62.77
W222	1-1/4" x 1/4"	1/4"	30,560+	60	60	\$25.42
W225	1-1/2" x 1/4"	1/4"	25,470+	60	60	\$36.84
W235	1-1/2" x 1/2"	1/4"	25,470+	60	60	\$34.99
W236	2" x 1"	1/4"	25,470+	60	60	\$58.45
W242	2" x 1"	1/4"	25,470+	60	60	\$58.45

Red General Purpose Mounted Points - These vitrified wheels are made with a clay bond along with premium white ALUMINUM OXIDE. They are best suited for grinding hardened tool steels which require a softer cutting wheel and will also effectively grind other materials such as hardened steels, glass, rubber, some stainless steels, wood, aluminum(hard), carbon steels and plastics.

Blue General Purpose Mounted Points - Also vitrified wheels, the blue mounted points are made with a porcelain bond along with regular ALUMINUM OXIDE grain. They are best suited for grinding low carbon steels or pre-hardened tool steels which require a tougher bond strength. These wheels will also effectively grind in heavier duty applications such as foundry work on castings, weld grinding on ferrous metals, hard brass and hard bronze.

Safety and Use of Mounted Wheels - Mounted wheels should be used with all the safety precautions recommended for grinding wheels. Each wheel should be inspected before use to make sure that the wheel is not damaged or the mandrel is not bent. Safe operating speeds are determined by shape and size, diameter of the mandrel and overhang (distance from end of support to base of wheel).

- DO NOT EXCEED THE SPEED INDICATED.
- DO NOT USE EXCESSIVE WORK PRESSURE.
- DO NOT OPERATE A MOUNTED WHEEL WHICH IS NOT CAREFULLY MOUNTED AND RUNNING TRUE.
- USE FACE PROTECTION AT ALL TIMES.

It is good practice, when starting hand grinders, to hold the grinder pointed downward and away from the operator until full operating speed is attained. If excessive vibration is felt, stop the grinder at once.

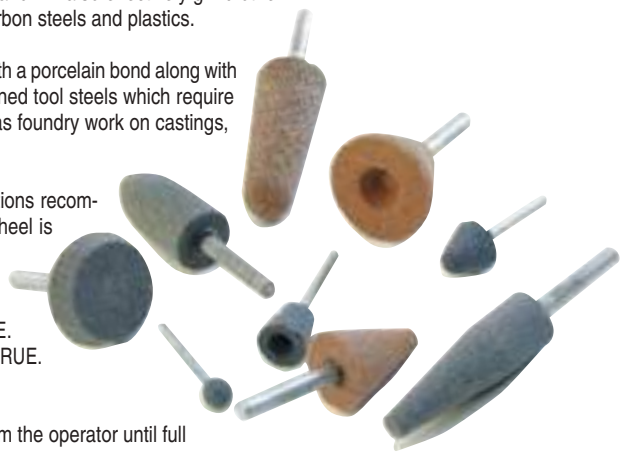

CARTRIDGE ROLLS

Item #	Size	Max RPM	Grit	Mandrel #	Description	Price Per 100
CR0601038AST	3/8" x 1-1/2" x 1/8"	25,000	60	2	Straight A/O	\$84.52
CR0801038AST	3/8" x 1-1/2" x 1/8"	25,000	80	2	Straight A/O	\$87.09
CR1201038AST	3/8" x 1-1/2" x 1/8"	25,000	120	2	Straight A/O	\$87.09
CR1801038AST	3/8" x 1-1/2" x 1/8"	25,000	180	2	Straight A/O	\$92.47
CR0601225AST	1/2" x 1" x 1/8"	25,000	60	1	Straight A/O	\$76.57
CR0801225AST	1/2" x 1" x 1/8"	25,000	80	1	Straight A/O	\$79.26
CR1201225AST	1/2" x 1" x 1/8"	25,000	120	1	Straight A/O	\$81.86
CR2401225AST	1/2" x 1" x 1/8"	25,000	240	1	Straight A/O	\$84.52
CR0401238AST	1/2" x 1-1/2" x 1/8"	25,000	40	2	Straight A/O	\$108.30
CR0601238AST	1/2" x 1-1/2" x 1/8"	25,000	60	2	Straight A/O	\$105.61
CR0801238AST	1/2" x 1-1/2" x 1/8"	25,000	80	2	Straight A/O	\$108.30
CR1201238AST	1/2" x 1-1/2" x 1/8"	25,000	120	2	Straight A/O	\$108.30
CR1801238AST	1/2" x 1-1/2" x 1/8"	25,000	180	2	Straight A/O	\$116.22
CR2401238AST	1/2" x 1-1/2" x 1/8"	25,000	240	2	Straight A/O	\$118.85
CR0601250AST	1/2" x 2" x 1/8"	25,000	60	3	Straight A/O	\$129.40
CR0801250AST	1/2" x 2" x 1/8"	25,000	80	3	Straight A/O	\$132.04
CR1201250AST	1/2" x 2" x 1/8"	25,000	120	3	Straight A/O	\$134.73
CR0602038AST	3/4" x 1-1/2" x 1/8"	25,000	60	2	Straight A/O	\$179.60
CR0802038AST	3/4" x 1-1/2" x 1/8"	25,000	80	2	Straight A/O	\$179.60
CR0602038BST	3/4" x 1-1/2" x 1/4"	25,000	60	4	Straight A/O	\$179.60
CR0802038BST	3/4" x 1-1/2" x 1/4"	25,000	80	4	Straight A/O	\$182.23
CR1202038BST	3/4" x 1-1/2" x 1/4"	25,000	120	4	Straight A/O	\$187.51
CR1002050AST	3/4" x 2" x 1/8"	25,000	100	3	Straight A/O	\$248.41
CR1202050AST	3/4" x 2" x 1/8"	25,000	120	3	Straight A/O	\$248.29
CR0601025AFT	3/8" x 1" x 1/8"	25,000	60	1	Full Taper A/O	\$79.22
CR0801025AFT	3/8" x 1" x 1/8"	25,000	80	1	Full Taper A/O	\$82.40
CR1201025AFT	3/8" x 1" x 1/8"	25,000	120	1	Full Taper A/O	\$137.30
CR1801025AFT	3/8" x 1" x 1/8"	25,000	180	1	Full Taper A/O	\$140.00
CR0501038AFT	3/8" x 1-1/2" x 1/8"	25,000	50	2	Full Taper A/O	\$145.26
CR0801038AFT	3/8" x 1-1/2" x 1/8"	25,000	80	2	Full Taper A/O	\$87.09
CR1201038AFT	3/8" x 1-1/2" x 1/8"	25,000	120	2	Full Taper A/O	\$87.09
CR0601225AFT	1/2" x 1" x 1/8"	25,000	60	1	Full Taper A/O	\$76.57
CR0801225AFT	1/2" x 1" x 1/8"	25,000	80	1	Full Taper A/O	\$79.26
CR0361238AFT	1/2" x 1-1/2" x 1/8"	25,000	36	2	Full Taper A/O	\$110.54
CR0601238AFT	1/2" x 1-1/2" x 1/8"	25,000	60	2	Full Taper A/O	\$105.61
CR0801238AFT	1/2" x 1-1/2" x 1/8"	25,000	80	2	Full Taper A/O	\$108.30
CR1201238AFT	1/2" x 1-1/2" x 1/8"	25,000	120	2	Full Taper A/O	\$108.30
CR1801238AFT	1/2" x 1-1/2" x 1/8"	25,000	180	2	Full Taper A/O	\$116.22
CR0601250AFT	1/2" x 2" x 1/8"	25,000	60	3	Full Taper A/O	\$129.40
CR0801250AFT	1/2" x 2" x 1/8"	25,000	80	3	Full Taper A/O	\$132.04
CR1201250AFT	1/2" x 2" x 1/8"	25,000	120	3	Full Taper A/O	\$134.73



Also available in Alumina Zirconia - call for pricing



Cartridge Rolls of 1" Length 3/4" Pilot Length
 Cartridge Rolls of 1-1/2" Length 1" Pilot Length
 Cartridge Rolls of 2" Length 1 1/2" Pilot Length

MANDRELS - CALL FOR OTHER SIZES

Mandrel Number	Item Number	Pilot	Pilot Length	Shank	Shank Length	Overall Length	Price Per Mandrel
1	CRMANDREL700717	1/8"	3/4"	1/4"	1-1/4"	2-1/2"	\$5.95
2	CRMANDREL710190	1/8"	1"	1/4"	1-1/4"	2-3/4"	\$5.94
3	CRMANDREL708875	1/8"	1-1/2"	1/4"	1-1/4"	3-1/4"	\$5.94
4	CRMANDREL712584	1/4"	1"	1/4"	1-1/4"	3"	\$5.93



SM 611 ABRASIVE FLAPWHEELS

Flapwheels in this column **require** SMD 612 Mounting Plates

Diameter x Width	Grit	Price Per Flapwheel	Diameter x Width	Grit	Price Per Flapwheel
4" x 2"	180	\$47.53	12" x 1-3/16"	180	\$191.30
9,500 RPM	100	\$45.42	3,200 RPM	100	\$177.12
	60	\$39.87	12" x 2"	180	\$266.28
	50	\$39.87	3,200 RPM	120	\$223.05
5-1/2" x 1"	240	\$47.53		60	\$191.30
6,800 RPM	180	\$39.87		50	\$191.30
	100	\$35.83	12" x 3"	240	\$424.03
	80	\$35.83	3,200 RPM	60	\$258.64
	60	\$32.22	14" x 2"	220	\$358.52
5-1/2" x 2"	220	\$60.37	2,500 RPM	120	\$284.19
6,800 RPM	100	\$55.71		80	\$284.19
	80	\$55.71	16" x 3"	320	\$674.71
	60	\$47.53	2,300 RPM	180	\$674.71
	40	\$47.53		60	\$459.44
10" x 1"	240	\$140.98			
3,800 RPM	180	\$122.93			
	120	\$106.43			
	80	\$106.43			
10" x 2"	320	\$226.51			
3,800 RPM	240	\$226.51			
	120	\$172.94			
	80	\$172.94			
	60	\$148.40			
	40	\$148.40			
	320	\$292.95			
10" x 3"	120	\$223.05			
3,800 RPM	60	\$191.30			

• 4", 5", 5 1/2", & 12" wheels can be customized to be used with mounting plates.

Flapwheels in these two columns **cannot use** SMD 612 Mounting Plates

Diameter x Width	Grit	Price Per Flapwheel	Diameter x Width	Grit	Price Per Flapwheel
6" x 1" x 1"	320	\$52.88	8" x 1" x 1"	240	\$97.79
	180	\$48.83	4,800 RPM	120	\$77.26
	120	\$42.00		100	\$77.26
	80	\$41.99		80	\$77.26
	60	\$38.55		60	\$66.91
	40	\$37.86	8" x 1 3/16" x 1"	180	\$97.79
6" x 2" x 1"	120	\$73.51	4,800 RPM	120	\$84.61
	80	\$68.41		80	\$84.07
	60	\$55.71		60	\$77.26
	50	\$53.44	8" x 2" x 1"	320	\$179.98
	40	\$43.23	4,800 RPM	220	\$152.11
6-1/2" x 1" x 1"	320	\$58.21		180	\$149.13
5,800 RPM	240	\$58.21		120	\$120.73
	220	\$52.89		100	\$120.73
	180	\$52.89		80	\$120.73
	120	\$45.02		60	\$100.46
	100	\$45.02		50	\$102.49
	80	\$45.02	10" x 2" x 1"	320	\$231.05
	60	\$41.02	3,800 RPM	240	\$226.51
	50	\$41.02		180	\$204.14
	40	\$41.02			
6-1/2" x 2" x 1"	320	\$95.07			
5,800 RPM	240	\$95.07			
	220	\$84.48			
	180	\$84.48			
	120	\$74.19			
	100	\$74.19			
	80	\$74.18			
	60	\$62.13			
	50	\$62.13			
	40	\$62.13			

** 1" arbor holes of 6", 8", & 10" wheels can be bored out to up to 1-1/2".
 *** The widths of 6", 8", & 10" wheels can be varied between 1/2" minimum width and 3" maximum width, with a 2-3 week lead time.

****While all SM 611 Flapwheels listed are available, not all are in-stock items. Inquire about availability.**

SM 612 MOUNTING PLATES

REQUIRED! Top quality alignment for your SM 611 flapwheels. For repeated use with SM 611 and the Mac Mop. Specify arbor hole size. **Flanges for 4" Flapwheels thru 12" Flapwheels are Galvanized Steel. Flanges for 14" Flapwheels thru 16" Flapwheels are Aluminum Castings.**

Flapwheel Diameter	Diameter of Plates (Inches)	Standard Bore (Inches)	Maximum Bore (Inches)	Price Per Pair
4"	2-3/16"	3/8"	3/4"	\$25.35
5-1/2"	2-3/16"	3/8"	3/4"	\$25.35
* 6-1/2"	3-1/8"	1/2"	1-11/16"	\$25.35
10"	4-3/4"	9/16"	2"	\$60.03
12"	6"	3/4"	2"	\$91.68
14"	8"	1"	3-1/8"	\$305.78
16"	9"	1"	3-1/8"	\$341.93

* Mac Mop mounting plate size.



The 8" flap wheel uses the same mounting plates as the 10" wheel

SPINDLE MOUNTED MAC MOP

The very best tool for final finishing, polishing, and making decorative finishes on severe profiles. 1/4" shank allows mounting in many 1/4" tools.

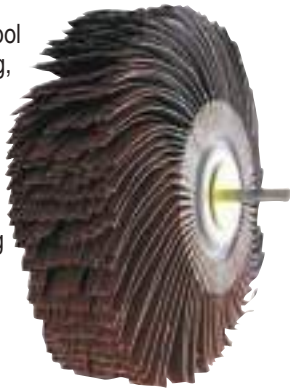

Dia x Width	Grit	Price Per Mop
7" x 1" x 1/4"	240	\$54.91
4,200 MAX RPM	180	\$54.91
	120	\$54.91
	80	\$54.91
7" x 2" x 1/4"	240	\$62.76
4,200 MAX RPM	180	\$62.76
	120	\$62.76
	80	\$62.76

MAC MOP



The very best tool for final finishing, polishing, and making decorative finishes on severe profiles.

Dia x Width	Grit	Price Per Mop
10" x 2"	180	\$219.43
3,400 MAX RPM	150	\$219.43
	120	\$189.69
	100	\$189.69
	80	\$189.69
10" x 4"	180	\$390.54
3,400 MAX RPM	150	\$390.54
	120	\$323.11
	100	\$323.11
	80	\$323.11

Recommended RPM 1,700 - 2,500

Must be used with KLINGSPOR SMD 612 - 6-1/2" mounting plates.

KM 613 SPINDLE MOUNTED FLAPWHEEL



VERY IMPORTANT NOT TO EXCEED RECOMMENDED RPM!

Superb for finish-sanding of small metal contoured parts, in and around radii or into holes. **Available Grits: 40, 60, 80, 120, 180, 240** • **Minimum Package: 1 Box of 10 per size and grit** *Other sizes are available. Please call for pricing.

Dia x Width x Spindle	Max RPM	Price Per Flapwheel
1" x 1/2" x 1/4"	30,000	\$7.78
1" x 1" x 1/4"	30,000	\$8.31
1-1/2" x 1/2" x 1/4"	25,000	\$8.83
1-1/2" x 1" x 1/4"	25,000	\$9.89
2" x 1/2" x 1/4"	25,000	\$10.30
2" x 3/4" x 1/4"	25,000	\$10.83
2" x 1" x 1/4"	25,000	\$11.65
2-1/2" x 1/2" x 1/4"	20,000	\$11.03
2-1/2" x 1" x 1/4"	20,000	\$12.53
2-1/2" x 2" x 1/4"	20,000	\$18.12
3" x 1/2" x 1/4"	12,000	\$11.80
3" x 3/4" x 1/4"	12,000	\$13.60
3" x 1" x 1/4"	12,000	\$14.60
3" x 2" x 1/4"	12,000	\$20.49



WSM 617

This useful and versatile flapwheel makes metal finishing easier. The WSM 617 has a solid center with a built-in 5/8"-11 threaded hole for use on most angle-grinders. With this type of flapwheel, the larger surface area of the face is used, making it a quicker way to apply finishing touches or a unique decorative finish to your metal workpiece. For extended life use at a slower RPM between 7,500 and 8,600. Sold 2 per box.

Dia x Width x Spindle	Max RPM	Recommended RPM	120 Grit	80 Grit	60 Grit	40 Grit
4-1/2" x 3/4" x 5/8" - 11"	13,300	8,600	\$31.43	\$31.43	\$29.67	\$29.67

WSM617 great for stainless steel kitchen manufacturers, and blending weld seams for a linear scratch pattern.



KLINGSPOR Flap Brush Part Order Number Reference Key

1ST AND 2ND LETTERS: Flap Brush Type	3RD LETTER: Arbor attachment	4TH AND 5TH LETTER: Material Grade	6TH LETTER: Base Material	7TH LETTER / NUMBER: Brush Density
NF – Full Non-Woven NI – Interleafed Non-Woven FB – Felt Brush	A – 1/4" Spindle shank B – 5/8"-11 C – 3/4" Keyway E – 1" Arbor Hole F – 2" Arbor Hole G – 3" Arbor Hole H – 5" Arbor Hole N – 1/4" - 20 Male	XC – Extra Coarse CR – Coarse MD – Medium VF – Very Fine UF – Ultra Fine NA – No Abrasive	T – Light Weight C&P Z – Zirconia B – High Strength Premium D – High Density Premium F – FMM or Felt A – Light Weight C&P in Very Fine Only	M – Medium Density (Standard) 3 – Digit Grit: Grit of the Interleafs 3 – Digit Diameter: Brush Diameter in mm 3 – Digit Width: Brush Width in mm

Part Number Example: **NI H MD T M 120 - 300 125**

SPINDLE MOUNTED BRUSHES

Max RPM - 12,000

- 1" x 1/2"\$9.46 each
- NFACRTM-025015
- NFAMDTM-025015
- NFAVFTM-025015
- NIACRTM060-025015
- NIAMDTM120-025015
- NIAVFTM180-025015
- SOLD IN BOXES OF 10**

- 2" x 1"\$16.80 each
- NFACRTM-050025
- NFAMDTM-050025
- NFAVFTM-050025
- NIACRTM060-050025
- NIAMDTM100-050025
- NIAMDTM150-050025
- NIAVFAM240-050025
- SOLD IN BOXES OF 5**

- 2-3/8" x 2"\$18.87 each
- NFAMDTM-060050
- NFAVFAM-060050
- SOLD IN BOXES OF 5**

- 1" x 1"\$9.46 each
- NFACRTM-025025
- NFAMDTM-025025
- NFAVFTM-025025
- NIACRTM060-025025
- NIAMDTM120-025025
- NIAVFTM180-025025
- SOLD IN BOXES OF 10**

- 2" x 2"\$33.60 each
- NFACRTM-050050
- NFAMDTM-050050
- NFAVFTM-050050
- NIACRTM060-050050
- NIAMDTM120-050050
- NIAVFTM180-050050
- SOLD IN BOXES OF 3**



Max RPM - 8,000

- 3" x 1"\$23.10 each
- NFACRTM-075025
- NFAMDTM-075025
- NFAVFTM-075025
- NIACRTM060-075025
- NIAMDTM120-075025
- NIAMDTM080-075025
- NIAVFTM180-075025
- SOLD IN BOXES OF 3**

- 3-1/8" x 2" Full Non-Woven
.....\$43.59 each
- NFAMDTM-079050
- NFAVFAM-079050
- 3-1/8" x 2" Interleaf
.....\$43.59 each
- NIACRTM060-079050
- NIAMDTM100-079050
- NIAMDTM150-079050
- NIAVFAM240-079050
- SOLD IN BOXES OF 3**

- 4" x 1-3/4"\$50.66 each
- NIACRTM060-100045
- NIAMDTM100-100045
- NIAMDTM150-100045
- NIAVFAM240-100045
- SOLD IN BOXES OF 2**

BUFFING BRUSHES
(BRUSHES FOR HAND HELD BUFFERS)



Brushes with 5/8"-11 Female Thread Max RPM - 4,500 **Not for use on angle grinders**

4" x 2" x 5/8"-11	Price
NFBXCTM-100050	\$69.29
NFBCRTM-100050	\$69.29
NFBMDTM-100050	\$69.29
NFBVFTM-100050	\$69.29
NIBCRTM060-100050	\$69.29
NIBMDTM120-100050	\$69.29
NIBVFTM180-100050	\$69.29

4-1/4" x 4" x 5/8"-11	Price
NFBXCTM-110100	\$107.63
NFBCRTM-110100	\$107.63
NFBMDTM-110100	\$107.63
NFBMDZM-110100	\$107.63
NFBVFTM-110100	\$107.63
NIBCRTM060-110100	\$114.34
NIBMDTM120-110100	\$114.34
NIBVFTM180-110100	\$114.34

BENCH & PEDESTAL GRINDER BRUSHES



SCAN HERE TO LEARN MORE ABOUT

POLISHING

6" x 2" x 1"	Price
NFEMDTM-150050	\$140.07
NIECRTM080-150050	\$147.06
NIEVFAM180-150050	\$147.06

12" x 1" x 5"	Price
NFHMDBM-300025	\$98.04

12" x 1.75" x 5"	Price
NFHMDBH-300045	\$179.74
NFHMDDM-300045	\$179.74

12" x 2" x 5"	Price
NFHMDBM-300050	\$176.48
NFHMDBX-300050	\$134.75

12" x 4" x 5"	Price
NFHMDTM-300100	\$301.36
NFHXCTM-300100	\$301.36

*** SEE MOUNTING PLATES ON PAGE 71**

FLAP WHEELS FOR BUFFING TOOLS

		Price
40 grit 4" x 4" x 5/8"-11	SM611040100100A	\$85.68
60 grit 4" x 4" x 5/8"-11	SM611060100100A	\$90.72
80 grit 4" x 4" x 5/8"-11	SM611080100100A	\$95.68
120 grit 4" x 4" x 5/8"-11	SM611120100100A	\$90.84
40 grit 4" x 2" x 5/8"-11	SM61104010050A	\$44.48
60 grit 4" x 2" x 5/8"-11	SM61106010050A	\$41.18
80 grit 4" x 2" x 5/8"-11	SM61108010050A	\$41.18

Product not guaranteed for use on Angle Grinder. Typical RPM's are too high. A variable speed angle grinder at low speed might be acceptable.



Brushes with 3/4" Keyway Arbor Hole Max RPM - 4,500

4-1/4" x 4" x 3/4" keyway	Price
NFCXCTM-110100	\$107.63
NFCCRTM-110100	\$107.63
NFCMDTM-110100	\$107.63
NFCMDZM-110100	\$107.63
NFCVFTM-110100	\$107.63
NICCRTM060-110100	\$114.34
NICMDTM120-110100	\$114.34
NICVFTM180-110100	\$114.34



KPW - KLINGSPOR Polishing Wheels

1ST 3 LETTERS:	4TH LETTER (Material):	3 DIGIT DIAMETER IN MM:	2 DIGIT THICKNESS IN MM:	2 DIGIT ARBOR HOLE IN MM:	1 DIGIT STITCH PATTERN:	1 OR 2 DIGIT STITCH SPACING:
KPW	Cotton Treated (C)	4" (100)	1/4" (06)	1/4" (06)	Spiral (A)	1 (1 inch)
	Sisal (S)	5" (127)	3/8" (10)	3/8" (10)	Concentric (B)	.5 (1/2 inch)
	Bramante (B)	6" (150)	1/2" (12)	1/2" (12)	Loose 1 Stitch (C)	.25 (1/4 inch)
	Sisal/Bramante (S/B)	10" (250)	3/4" (20)	3/4" (20)	Loose 3 Stitch (D)	
		12" (300)	1" (25)	1" (25)	Loose 2 Stitch (E)	
		14" (350)		1-1/4" (32)		
		16" (400)				
		18" (460)				
KPW	B	150	25	20	A	1



POLISHING WHEELS

Call for additional sizes

AWB - Airway Buff

1ST 6 LETTERS:	2ND LETTER MATERIAL:	3 DIGIT DIAMETER IN MM:	2 DIGIT ARBOR HOLE IN MM:	2-3 DIGIT PLY:		Price
AWB	Cotton (B)	12" (300)	5" (127)	4 Ply (4P)	6" x 1" x 1" - Concentric Cotton	KPWT1502525B.5 \$15.86
	Cotton (C)	14" (350)		16 Ply (16P)	6" x 1/2" x 5/8" - Treated Cotton	KPWC1501216B.5 \$19.30
	NWT CR	16" (400)			6" x 3/4" x 5/8" - Stitched Sisal	KPWS1502016A.25 \$12.99
	NWT MD	18" (450)				
	NWT FN					
	NWT VF					
AWBNWT	FN	400	127	4P		

Only AIRWAY BUFFS are available with a 5" Arbor ring and come in 14" and 16" wheels

KPWREDUCT5T01-1/2 STEEL REDUCTION 5"to 1-1/2"

Most Aggressive



Least Aggressive



POLISHING COMPOUNDS

● Recommended

Polish Compounds	Treated Sisal	Natural Sisal	Mill Treated Cotton	Denim	Canvas	Natural Cotton	Flannel
KPC2U	●	●	●				
KPC3U			●	●	●		
KPC4U				●	●	●	
KPC5U						●	●
KPC4SF			●	●	●	●	

KPC2U- 20% Color 80% cut • KPC3U- 50% Color 50% cut • KPC4S- 70% Color 30% cut • KPC4SF- 80% Color 20% Cut • KPC5S- 100% Color

KPC2U Product Features / Benefits:

Heavy cut compound, 80% cut and 20% color. Ideal for stainless steel, carbon steel and hard aluminum, for pre-polish process. Will remove some light scratches from previous sanding.

KPC2U - HEAVY CUT GREEN \$12.35

KPC3U Product Features / Benefits:

Medium cut compound. 50% cut and 50% color. Ideal for start polishing non-ferrous metals. Removes some minor scratches from previous sanding. Suitable for use with bias airway buff, cotton & denim wheels.

KPC3U - MEDIUM CUT WHITE..... \$12.35

KPC4S Product Features / Benefits:

For mirror finishing process. Provides a great shine, 30% cut and 70% color. Final step after pre-polish with either KCP2 or KCP3. Used with treated and non-treated airway buff wheel, sewing cotton wheels or felt fabric. Offers shine finishing for all metals in general.

KPC4S - UNIVERSAL FINISHING RED..... \$17.85

KPC5S Product Features / Benefits:

Compound for a high gloss. Extra shine for metals in general. Excellent for jewelry, some plastics and paint. Mostly used with flannel, cotton and felt.

KPC5S - UNIVERSAL FINAL FINISH YELLOW \$43.95

KPC4SF Product Features / Benefits:

Suitable for mirror polishing on all kinds of metal surfaces especially stainless steel in manual or automatic polishing processes. Also very good results on titanium and chrome.

KPC4SF - SUPER FINISH BLUE..... \$14.81



FELT PRODUCTS

		Price
2" x 1" x 1/4"	FBANAFM-050025	\$16.33
4-1/4" x 4" x 5/8"-11	FBBNAFM-110100	\$108.85
4-1/4" x 4" x 3/4" keyway	FBCNAFM-110100	\$108.85
2" QRC	QRCF1200 Per Box of 25	\$41.00
3" QRC	QRCF1300 Per Box of 25	\$61.50
4-1/2" x 7/8" Felt Polishing Disc	FPD600115022	\$11.45
5" x 7/8" Felt Polishing Disc	FPD600125022	\$12.72





CLOTH SPIRAL (NO LAP) BANDS

Perfect for edge sanding or in and around holes on metals or wood. May be used on spindle sanders, drill presses or hand held tools. Made from our heavy cloth ALUMINUM OXIDE material.

Dia x Width	Grit	Price Per Box
1/2" x 1/2"	150	\$21.45
25/Box	100	\$21.45
	60	\$21.45
1/2" x 1"	150	\$22.04
25/Box	100	\$22.04
	60	\$22.04
1/2" x 1-1/2"	100	\$23.89
25/Box	60	\$23.89
1/2" x 2"	150	\$31.23
25/Box	100	\$31.23
	60	\$31.23
3/4" x 1"	150	\$22.04
25/Box	100	\$22.04
	60	\$22.04
3/4" x 1-1/2"	60	\$25.75
25/Box		
3/4" x 3"	100	\$49.72
25/Box		
1" x 1"	150	\$23.28
25/Box	100	\$23.28
	60	\$23.89
1" x 1-1/2"	150	\$26.34
25/Box	100	\$26.34
	60	\$26.94
1" x 2"	150	\$36.14
25/Box	100	\$36.14
	60	\$37.97
1" x 3"	150	\$53.27
25/Box	100	\$53.27
	60	\$55.14
1-1/2" x 1"	150	\$23.89
25/Box	100	\$23.89
	60	\$25.14
1-1/2" x 1-1/2"	150	\$27.58
25/Box	100	\$27.58
	60	\$28.18
1-1/2" x 2"	150	\$38.58
25/Box	100	\$38.58
	60	\$39.38
1-1/2" x 2-1/2"	60	\$48.40
25/Box		
1-1/2" x 3"	150	\$56.98
25/Box	100	\$56.98
	60	\$58.80

Dia x Width	Grit	Price Per Box
2" x 1"	150	\$26.34
25/Box	100	\$26.34
	60	\$26.94
2" x 1-1/2"	150	\$31.23
25/Box	100	\$31.23
	60	\$33.68
2" x 2"	150	\$42.23
25/Box	100	\$42.23
	60	\$44.10
2" x 3"	150	\$63.10
25/Box	100	\$63.10
	60	\$66.17

Also available in Alumina Zirconia - call for pricing

SPIRAL BANDS FOR OSCILLATING SPINDLE SANDERS

Dia x Width	Grit	Price Per Box
1/2" x 4-1/2" 10/Box	150	\$26.61
	100	\$26.61
	60	\$26.87
3/4" x 4-1/2" 10/Box	150	\$28.09
	100	\$28.09
	60	\$28.60
1" x 4-1/2" 10/Box	150	\$29.29
	100	\$29.29
	60	\$30.98
1-1/2" x 4-1/2" 10/Box	150	\$31.45
	100	\$31.45
	60	\$32.21
2" x 4-1/2" 10/Box	150	\$42.83
	100	\$42.83
	60	\$44.74
3" x 4-1/2" 10/Box	150	\$48.63
	100	\$48.63
	60	\$51.06
1/2" x 9" 10/Box	150	\$56.42
	100	\$56.42
	60	\$56.90
3/4" x 9" 10/Box	150	\$60.00
	100	\$60.00
	60	\$61.24
1" x 9" 10/Box	150	\$62.93
	100	\$62.93
	60	\$65.56
1-1/2" x 9" 10/Box	150	\$67.27
	100	\$67.27
	60	\$69.64
2" x 9" 10/Box	150	\$74.04
	100	\$74.04
	60	\$77.92
3" x 9" 10/Box	150	\$85.20
	100	\$85.20
	60	\$90.01

RUBBER DRUMS



For use with cloth spiral bands.

Dia x Width x Shank Size	Max RPM	Price Per Drum
1/2" x 1/2" x 1/4"	30,000	\$11.49
1/2" x 1" x 1/4"	15,000	\$11.39
3/4" x 1" x 1/4"	13,000	\$11.34
3/4" x 1-1/2" x 1/4"	10,000	\$14.51
3/4" x 2" x 1/4"	9,000	\$16.48
1" x 1" x 1/4"	18,000	\$11.80
1" x 1-1/2" x 1/4"	10,000	\$14.56
1" x 2" x 1/4"	8,000	\$16.52
1" x 3" x 1/4"	6,000	\$21.43
1-1/2" x 1" x 1/4"	14,000	\$14.90
1-1/2" x 1-1/2" x 1/4"	10,000	\$16.57
1-1/2" x 2" x 1/4"	7,000	\$24.62
2" x 1" x 1/4"	11,000	\$16.53
2" x 1-1/2" x 1/4"	8,000	\$24.64
2" x 2" x 1/4"	6,000	\$32.93
2" x 3" x 1/4"	4,000	\$36.67

Common sizes listed - call for others.

Other Grits Available.

WIRE BRUSHES AND WHEELS



CRIMP WIRE WHEEL

Item Number	Dia	Description	Wire Size	Shank	Max RPM	Price Each
KWW-9160036	1-1/2"	Crimp Wheel CS	.006	1/4" shank	15,000	\$14.58
KWW-9165746	2"	Crimp Wheel CS	.006	1/4" shank	15,000	\$22.49
KWW-382006	2"	Crimp Wheel CS	.012	1/4" shank	15,000	\$18.48
KWW-164830	2-1/2"	Crimp Wheel CS	.014	1/4" shank	15,000	\$25.64
KWW-382007	3"	Crimp Wheel CS	.012	1/4" shank	15,000	\$19.82
KWW-381726	3"	Crimp Wheel SS	.014	1/4" shank	15,000	\$28.14



KNOT WHEEL WITH SHANK

Item Number	Dia	Description	Wire Size	Shank	Max RPM	Price Each
KWW-90388861	3"	Knot Wheel CS	.014	1/4" shank	25,000	\$36.63
KWW-9039831	4"	Knot Wheel CS	.014	1/4" Shank	20,000	\$42.18



SMALL DIAMETER CRIMP WIRE WHEEL

Item Number	Dia	Description	Wire Size	Shank	Max RPM	Price Each
KWW-110461	2-1/2"	Crimp Wheel CS	.008	1/2"	20,000	\$15.58
KWW-110581	3"	Crimp Wheel CS	.008	1/2"	20,000	\$17.52
* KWW-9111791	3"	Crimp Wheel CS	.012	1/2"-3/8"	20,000	\$13.96
KWW-9162651	3"	Crimp Wheel SS	.006	1/2"	20,000	\$32.24
* KWW-9110971	3"	Crimp Wheel SS	.014	1/2"-3/8"	20,000	\$22.27

* COMES WITH BUSHING



LARGE DIAMETER CRIMP WIRE WHEEL

Item Number	Dia	Description	Wire Size	Arbor	Max RPM	Price Each
● KWW-9099521	6"	Crimp Wheel CS	1/2" .014	1/2"-5/8"	6,000	\$60.53
● KWW-210332	8"	Crimp Wheel CS	1" .014	1-1/4"*	4,500	\$50.76
* KWW-220911	8"	Crimp Wheel CS	1-1/2" .014	5/8"	4,500	\$104.33

* COMES WITH ADAPTOR ● USES ADAPTOR BELOW IN YELLOW



CRIMPED CUP BRUSH

Item Number	Dia	Description	Wire Size	Arbor	Max RPM	Price Each
KWW-322351	3"	Crimp Cup CS	.014	3/8-24	12,500	\$36.88
KWW-381930	3"	Crimp Cup CS	.014	5/8-11	12,500	\$30.43
KWW-381932	4"	Crimp Cup CS	.014	5/8-11	8,500	\$39.00
KWW-099641	6"	Crimp Cup CS	.014	5/8-11	6,600	\$47.18

TWISTED KNOT CUP BRUSH

Item Number	Dia	Description	Wire Size	Arbor	Max RPM	Price Each
KWW-381997	2-3/4"	Knot Cup CS	.014	5/8-11	12,500	\$33.71
KWW-381996	2-3/4"	Knot Cup CS	.020	5/8-11	12,500	\$34.62
KWW-381999	2-3/4"	Knot Cup SS	.020	5/8-11	12,500	\$59.96
KWW-382000	4"	Knot Cup CS	.025	5/8-11	9,000	\$75.71
KWW-381730	6"	Knot Cup CS	.035	5/8-11	6,600	\$120.47

* ADAPTORS FOR ARBOR REDUCTION KWW-ADAPTER1/2, KWW-ADAPTER3/4, KWW-ADAPTER5/8





WIRE BRUSHES AND WHEELS

KNOT WHEEL



Item Number	Dia	Description	Wire Size	Arbor	Max RPM	Price Each
KWW-9265871	4"	Knot Wheel CS	.014	5/8-11	20,000	\$25.54
KWW-382070	4"	Knot Wheel CS	.020	5/8-11	20,000	\$24.70
KWW-9265931	4"	Knot Wheel SS	.014	5/8-11	20,000	\$38.32
KWW-382001	4"	Knot Wheel SS	.020	5/8-11	20,000	\$45.30
KWW-381734	6"	Knot Wheel CS	.025	5/8-11	12,500	\$42.13
KWW-9264871	4"	Cable Knot Wheel CS	.020	5/8-11	20,000	\$29.18
KWW-9263411	4"	Cable Knot Wheel SS	.020	5/8-11	20,000	\$56.48

STRINGER BEAD



Item Number	Dia	Description	Wire Size	Arbor	Max RPM	Price Each
KWW-382065	4"	Stringer Bead Wheel CS	.020	5/8-11	20,000	\$30.15
KWW-382066	4"	Stringer Bead Wheel SS	.020	5/8-11	20,000	\$42.67
KWW-382068	6"	Stringer Bead Wheel CS	.020	5/8-11	12,500	\$40.52
KWW-382069	6"	Stringer Bead Wheel SS	.020	5/8-11	12,500	\$45.96

CRIMPED SMALL GRINDER WIRE WHEEL



Item Number	Dia	Description	Wire Size	Arbor	Max RPM	Price Each
KWW-9213171	4"	Crimped Wheel CS	.014	5/8-11	15,000	\$27.82

CRIMP END BRUSH



Item Number	Dia	Description	Wire Size	Arbor	Max RPM	Price Each
KWW-9029501	1"	Crimp End CS	.008	1/4" shank	20,000	\$14.75
KWW-381928	1"	Crimp End CS	.014	1/4" shank	20,000	\$6.76
KWW-026511	1"	Crimp End CS	.020	1/4" shank	20,000	\$7.11
KWW-381929	1"	Crimp End SS	.014	1/4" shank	20,000	\$25.60
KWW-381925	3/4"	Crimp End CS	.006	1/4" shank	20,000	\$8.57
KWW-381926	3/4"	Crimp End CS	.014	1/4" shank	20,000	\$8.57
KWW-301611	3/4"	Crimp End CS	.020	1/4" shank	20,000	\$10.98
KWW-381927	3/4"	Crimp End SS	.014	1/4" shank	20,000	\$9.06
KWW-301911	1/2"	Crimp End CS	.006	1/4" shank	25,000	\$8.20
KWW-301941	1/2"	Crimp End CS	.014	1/4" shank	20,000	\$8.20
KWW-301951	1/2"	Crimp End CS	.020	1/4" shank	20,000	\$8.20
KWW-301741	1/2"	Crimp End SS	.006	1/4" shank	20,000	\$10.93
KWW-9301971	1/2"	Crimp End SS	.014	1/4" shank	20,000	\$8.83

WIRE BRUSHES AND WHEELS



CRIMP END BRUSH WITH SCUFF GUARD

Item Number	Dia	Description	Wire Size	Shank	Max RPM	Price Each
KWW-301341	3/4"	Crimp End CS	.006	1/4" shank SCUF	22,000	\$27.87
KWW-027251	3/4"	Crimp End SS	.014	1/4" shank SCUF	22,000	\$29.48



KNOT END BRUSH

Item Number	Dia	Description	Wire Size	Shank	Max RPM	Price Each
KWW-381830	1"	Knot End CS	.014	1/4" shank	20,000	\$13.25
KWW-381832	1"	Knot End CS	.020	1/4" shank	20,000	\$13.76
KWW-381831	1"	Knot End SS	.014	1/4" shank	20,000	\$7.95
KWW-027441	1"	Knot End SS	.020	1/4" shank	20,000	\$23.93
KWW-381833	3/4"	Knot End CS	.014	1/4" shank	20,000	\$12.40
KWW-381835	3/4"	Knot End CS	.020	1/4" shank	20,000	\$10.59
KWW-381834	3/4"	Knot End SS	.014	1/4" shank	20,000	\$6.89

SCRATCH BRUSHES

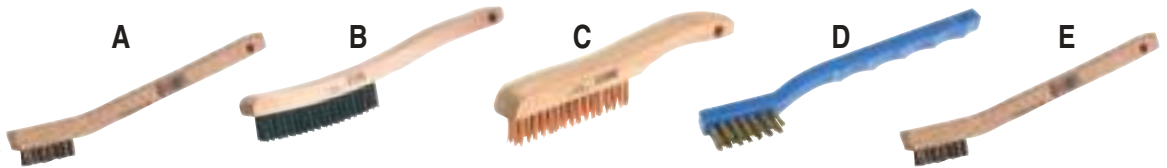

Item Number	Description	Area Length	Area Width	Overall Length	Fill Diameter	Fill Material	Wire Rows	Trim Length	Price Each
A KWW-381940	Angle Back Wood	1-3/8"	1/4"	7-3/4"	.014	Stainless Steel	3" x 7"	1/2"	\$4.06
B KWW-381944	Long Handle Wood	5-1/2"	3/4"	13-3/4"	.014	Steel	3" x 19"	1-1/8"	\$5.64
C KWW-381942	Shoe Handle Wood	4-1/2"	7/8"	9-1/2"	.014	Steel	4" x 16"	1-1/8"	\$5.30
D KWW-831111	Angle Back Plastic	1-1/2"	1/4"	7-1/4"	.006	Stainless Steel	3" x 7"	7/16"	\$5.36
D KWW-381938	Angle Back Plastic	1-1/2"	1/4"	7-1/4"	.006	Brass	3" x 7"	7/16"	\$4.92
E KWW-381941	Long Handle Wood	1-1/2"	1/4"	7-3/4"	.006	Brass	3" x 7"	7/16"	\$3.01

POWER WHEEL



These wheels will replace your wire wheels for removing surface contaminants while leaving a fine finish. Constructed of large nylon filament with coarse silicon carbide grain, this open structure provides aggressive removal and blending characteristics without loading. Applications include: removal of paints and other surface coatings, cleaning of weld discoloration, blending, and removing corrosion, rust and scale.

Size & Description	Recommended RPM	Maximum RPM	Price Per Wheel
4" dia. with 1/2" arbor	3,700 - 4,200	7,600	\$17.28
6" dia. with 1/2" arbor	2,500 - 3,000	5,000	\$29.61

The KLINGSPOR reusable arbor system is unique in that it comes with a series of "washers" which allows for optimum support as the wheel wears away.

Reusable arbor - 5/16"	\$17.26	Reusable arbor - 1/4"	\$17.26
------------------------	---------	-----------------------	---------

All Power Wheels have a 1/2" center hole. Mandrels both have a 1/2" insertion end and either a 1/4" or 5/16" shank.



SANDING STARS



4" DIAMETER X 1/4" SHANK

Max RPM	Grit	Price
3,200	80 Grit	\$17.02
3,200	100 Grit	\$17.02
3,200	120 Grit	\$17.02
3,200	150 Grit	\$17.02
3,200	180 Grit	\$17.02
3,200	220 Grit	\$17.02

4" DIAMETER X 1/2" HOLE / NO SHANK

Max RPM	Grit	Price
3,200	80 Grit	\$6.38
3,200	100 Grit	\$6.38
3,200	120 Grit	\$6.38
3,200	150 Grit	\$6.38
3,200	180 Grit	\$6.38
3,200	220 Grit	\$6.38

GRAPHITE STICKS

Graphite sticks are used to lubricate belt backings used in mold sanding.



Graphite Sticks

\$20.51 each

CLEANING STICKS

Cleaning Sticks 8" x 2" x 2"

\$33.39 each

Loaded wood particles and resin are easily cleaned away with this all-natural stick. No chemicals needed, simply hold the stick firmly against the moving belt or disc and watch in amazement. Best if used right after sanding, before the abrasive cools down.

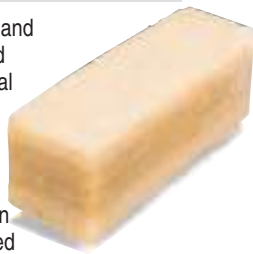

VONNEGUT LOADINGS



These loadings will completely fill an 8 head 32 brush unit, or will supply 2 loadings for the 4 head 16 brush unit.

AVAILABLE MATERIAL LS309 (ALUMINUM OXIDE) OR CS321 (SILICON CARBIDE)
4 SHEETS PER ASSEMBLY

Width x Length	Grit	Price Per Each
4" x 19" (8 assemblies)	80+	\$274.67
6" x 19" (8 assemblies)	80+	\$320.19

Available Grits Include: 80, 100, 120, 150, 180, 220.
Standard Loadings are 1/4" Skip Staggered.

HEAVY DUTY GRAPHITE ROLLS



Heavy duty graphite-coated canvas will extend the life of your belts by reducing heat and friction. Single and 2 ply available.

F1 felt also available for platens on wide belt sanders. Call for information.

Size	Price Per Roll
3" x 10 yard	\$92.15
4" x 10 yard	\$143.34
6" x 10 yard	\$184.30
9" x 10 yard	\$276.44
12" x 10 yard	\$373.98

GREASE STICK

GREASESTICK26 \$23.23 each

Grease Sticks are formulated to reduce heat while combating loading on the belt surface. The grease stick is meant to go on coarse (24-120) grit belts to increase longevity and the cutting ability of your belts.



FLUTTER SHEETS

KLINGSPOR flutter sheets are manufactured from our flexible cloth-backed premium LS 309JF ALUMINUM OXIDE material.



Size	Grit	Price Per Sheet
2" x 4" x 1/2"	320-100	\$0.58
8 End Slits	80	\$0.58
2" x 6" x 1/2"	320-100	\$0.75
4 & 8 End Slits	80	\$0.86

Please call for availability of other sizes.
• 50 Sheets Per Box

FLUTTER ARBOR List Price

1/2" flutter arbor with 1/4" shank
ARBOR1/2X1/4FH.....\$6.09 ea.

Flutter sheet spacers
(1/2" ID x 3/4" OD) 10 pack

FLUTTERSHTSPACR.....\$9.15 ea.

Tips for Flutter Sheet Set Up & Use

- Place two sheets back to back, see Fig. A
- Crisscross sheets to form a wheel, see Fig. B and Fig. C.
- Repeat the pattern until you have 15 to 20 sheets on the arbor, then tighten the nut to hold sheets together.
- Secure the assembly in your drill press, hand held drill, lathe, etc. Be sure to tighten the chuck adequately. Operate at a maximum speed of 2300 RPM, and we strongly suggest you DO NOT exceed this speed.
- Before using the flutter sheets on your project, break in the edge by holding a piece of scrap hardwood against it as it spins. This will "soften" the edge so that it doesn't gouge your work.

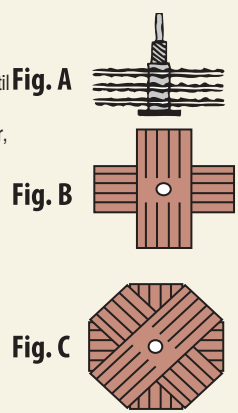

Asphalt & Concrete Diamond Blades

Concrete

Diamond cutting blade

DT 350 BT EXTRA



Also available in 20mm

Properties:	
Design	Laser welded
Segmentation	Turbo
Aggression	■■■■■■■□
Service life	■■■□□□□

Applications:	
Concrete	●
Cured concrete, reinforced	○
Hardscape	●
Paving	●

Advantages: Special turbo segments for an extremely high cutting speed on concrete and all concrete products - Fast and easy cutting with low vibration - Optimum service life - Optimum price-performance ratio

Diameter x Bore	Max Operating Speed	Max RPM's	Machine	Segment Dimensions			Price	
				Number	Length	Width		
14" x 1"	80 m/s	5,500 rpm	Gas Saw	22	1.57"	0.118"	0.472"	\$190.36

Asphalt and Concrete

Diamond cutting blade

DT 612 UT SUPRA

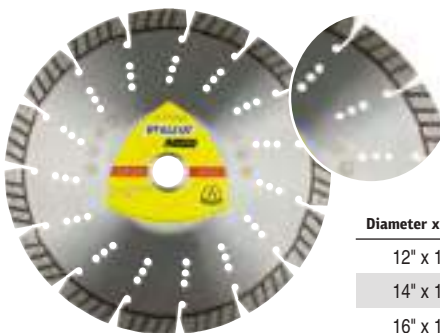

Also available in 20mm

Properties:	
Design	Laser welded
Segmentation	Turbo
Aggression	■■■■■■■□
Service life	■■■■■□□

Applications:	
Construction materials	●
Concrete	●
Cured concrete, reinforced	●
Chalky sandstone	●
Asphalt roads	●



• Turbo segments

Advantages: Special turbo segments for an extremely high cutting speed on almost all hard materials - Excellent service life even on reinforced concrete

Diameter x Bore	Max Operating Speed	Max RPM's	Machine	Segment Dimensions			Price	
				Number	Length	Width		
12" x 1"	100 m/s	6,400 rpm	Gas Saw	20	1.57"	0.110"	0.472"	\$207.56
14" x 1"	100 m/s	5,500 rpm	Gas Saw	22	1.57"	0.118"	0.472"	\$244.88
16" x 1"	100 m/s	4,800 rpm	Gas Saw	26	1.57"	0.126"	0.472"	\$281.11

Asphalt and Concrete

Diamond cutting blade

DT 900 B SPECIAL

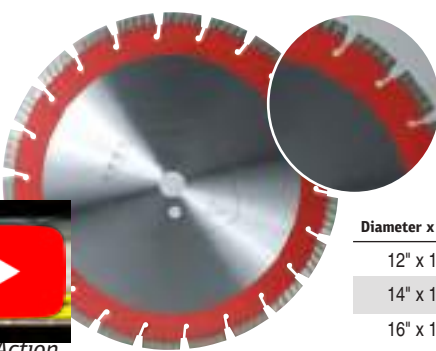

Also available in 20mm

Properties:	
Design	Laser welded
Segmentation	Turbo
Aggression	■■■■■■■□
Service life	■■■■■■■

Applications:	
Cured concrete, reinforced	●
Asphalt roads	●
High aggregate concrete	●



• Turbo segments
• Titanium-coated diamonds

Advantages: High performance blade with ultra high cutting speed thanks to turbo segments - Specially engineered for effortless cutting through concrete - Further increased service life thanks to titanium-coated diamonds

Diameter x Bore	Max Operating Speed	Max RPM's	Machine	Segment Dimensions			Price	
				Number	Length	Width		
12" x 1"	100 m/s	6,400 rpm	Gas Saw	20	1.57"	0.110"	0.472"	\$262.20
14" x 1"	100 m/s	5,500 rpm	Gas Saw	22	1.57"	0.118"	0.472"	\$295.43
16" x 1"	100 m/s	4,800 rpm	Gas Saw	26	1.57"	0.126"	0.472"	\$386.25



See In Action

Concrete

Diamond cutting blade

DT 900 UX SPECIAL

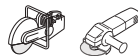

Also available in 20mm

Properties:	
Design	Laser welded
Segmentation	Standard
Aggression	■■■■■■■□
Service life	■■■■■■■

Applications:	
Concrete	●
Construction Materials	●
Cured concrete, reinforced	●



• Titanium-coated diamonds

Advantages: Special arrangement of the diamonds ensures a very high cutting speed and good service life - Ideally suited for almost all construction materials

Diameter x Bore	Max Operating Speed	Max RPM's	Machine	Segment Dimensions			Price	
				Number	Length	Width		
14" x 1"	100 m/s	5,500 rpm	Gas Saw	22	1.57"	0.118"	0.472"	\$359.64
16" x 1"	100 m/s	4,800 rpm	Gas Saw	26	1.57"	0.142"	0.472"	\$456.06
18" x 1"	100 m/s	4,300 rpm	Walk Behind	30	1.57"	0.142"	0.472"	\$474.86
20" x 1"	100 m/s	3,900 rpm	Walk Behind	34	1.57"	0.142"	0.472"	\$647.66





Asphalt

Diamond cutting blade

DT 350 A EXTRA

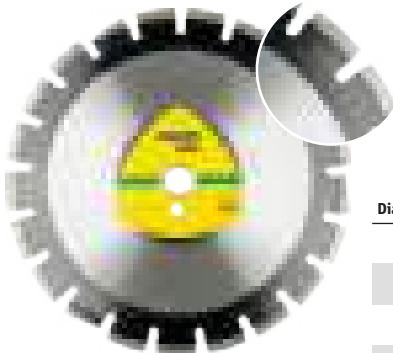

Properties:

Design	Laser welded
Segmentation	Wide gullet
Aggression	■ ■ ■ ■ ■ □ □ □
Service life	■ ■ ■ ■ □ □ □ □

Applications:

Asphalt	●
Green	●
Concrete	●



• Protective incline segments

Advantages: Best price to performance blade for asphalt and green concrete.

Segment Dimensions

Diameter x Bore	Max Operating Speed	Max RPM's	Machine	Number	Length	Width	Height	Price
12" x 1"	100 m/s	6,400 rpm	Gas Saw	18	1.57"	0.110"	0.394"	\$123.76
14" x 1"	100 m/s	5,500 rpm	Gas Saw	24	1.57"	0.126"	0.394"	\$126.77
16" x 1"	100 m/s	4,800 rpm	Gas Saw	24	1.57"	0.134"	0.394"	\$187.14
18" x 1"	100 m/s	4,300 rpm	Gas Saw	24	1.57"	0.134"	0.394"	\$268.64
20" x 1"	100 m/s	3,900 rpm	Gas Saw	24	1.57"	0.134"	0.394"	\$333.54

Asphalt

Diamond cutting blade

DT 602 A SUPRA

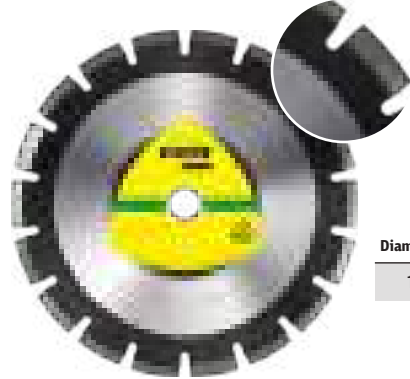

Properties:

Design	Laser welded
Segmentation	Wide gullet
Aggression	■ ■ ■ ■ ■ □ □ □
Service life	■ ■ ■ ■ □ □ □ □

Applications:

Asphalt	●
Green concrete	●



• Protective segments

Advantages: First-rate cutting performance - Protective segments to guard the blade - Great price-performance ratio - Specially engineered for applications on asphalt - Also suitable for use on electric joint cutters

Segment Dimensions

Diameter x Bore	Max Operating Speed	Max RPM's	Machine	Number	Length	Width	Height	Price
16" x 1"	100 m/s	4,800 rpm	Gas Saw	24	1.57"	0.134"	0.394"	\$363.07

Asphalt

Diamond cutting blade

DT 902 A SPECIAL

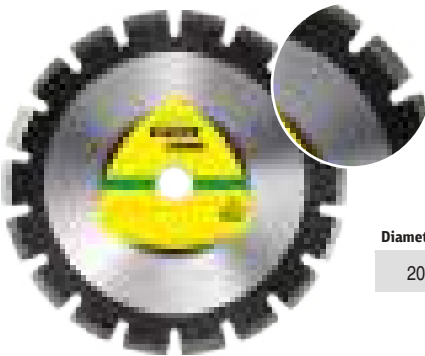

Properties:

Design	Laser welded
Segmentation	Wide gullet
Aggression	■ ■ ■ ■ ■ □ □ □
Service life	■ ■ ■ ■ ■ □ □ □

Applications:

Asphalt	●
Sandstone	●
Green concrete	●
Screed	●



• Protective segments

Advantages: High cutting performance - 12 mm high segments - Protective segments to guard the blade

Segment Dimensions

Diameter x Bore	Max Operating Speed	Max RPM's	Machine	Number	Length	Width	Height	Price
20" x 1"	100 m/s	3,900 rpm	Walk Behind	30	1.57"	0.146"	0.472"	\$686.75



Concrete

Diamond cutting blade

DT 602 B SUPRA

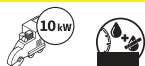
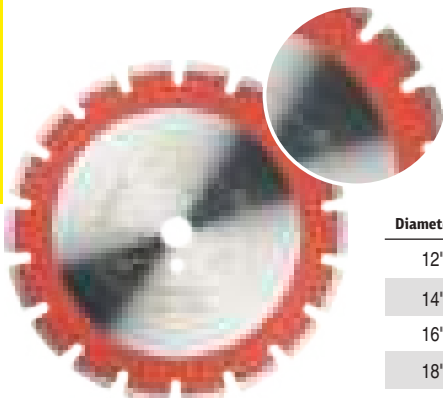

Properties:	
Design	Laser welded
Segmentation	Wide gullet
Aggression	■■■■■□□
Service life	■■■■■□□

Applications:	
Cured concrete	●
Cured concrete, reinforced	●

Advantages: First-rate cutting performance - Fast cutting speed - Particularly well suited for concrete with medium reinforcement - Also suitable for use on electric joint cutters

Diameter x Bore	Max Operating Speed	Max RPM's	Machine	Segment Dimensions				Price
				Number	Length	Width	Height	
12" x 1"	100 m/s	6,400 rpm	Walk Behind	18	1.57"	0.110"	0.354"	\$186.53
14" x 1"	100 m/s	5,500 rpm	Walk Behind	21	1.57"	0.126"	0.354"	\$242.98
16" x 1"	100 m/s	4,800 rpm	Walk Behind	24	1.57"	0.134"	0.354"	\$302.88
18" x 1"	100 m/s	4,300 rpm	Walk Behind	25	1.57"	0.146"	0.354"	\$368.82
20" x 1"	100 m/s	3,900 rpm	Walk Behind	30	1.57"	0.146"	0.354"	\$442.60

Concrete

Diamond cutting blade

DT 902 B SPECIAL

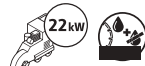

Properties:	
Design	Laser welded
Segmentation	Wide gullet
Aggression	■■■■■■■
Service life	■■■■■■■□

Applications:	
Cured concrete	●
Cured concrete, reinforced	●
High-aggregate concrete	●
Asphalt roads	●

Advantages: First-rate cutting performance - Ultra fast cutting speed - Also suitable for concrete with strong reinforcement

Diameter x Bore	Max Operating Speed	Max RPM's	Machine	Segment Dimensions				Price
				Number	Length	Width	Height	
14" x 1"	100 m/s	5,500 rpm	Walk Behind	21	1.57"	0.126"	0.433"	\$288.86
16" x 1"	100 m/s	4,800 rpm	Walk Behind	24	1.57"	0.134"	0.433"	\$352.67
18" x 1"	100 m/s	4,300 rpm	Walk Behind	26	1.57"	0.146"	0.433"	\$429.39
20" x 1"	100 m/s	3,900 rpm	Walk Behind	30	1.57"	0.146"	0.433"	\$521.94

Concrete

Diamond cutting blade

DT 910 BF SPECIAL

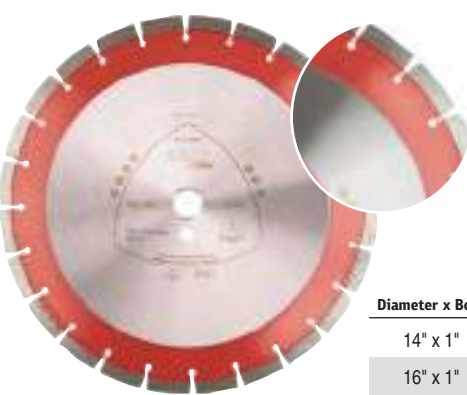

Properties:	
Design	Laser welded
Segmentation	Narrow gullet
Aggression	■■■■■■■
Service life	■■■■■■■

Applications:	
Green concrete	●
Building construction	●
Drilling and saw operations	●
Road construction	●
High-aggregate concrete	●
Asphalt roads	●



- 12mm segments
- Dropsegment

Advantages: Smooth and easy cutting performance, 12 mm tall segments, Protective segments shield the core, Outstanding service life

Diameter x Bore	Max Operating Speed	Max RPM's	Machine	Segment Dimensions				Price
				Number	Length	Width	Height	
14" x 1"	100 m/s	5,500 rpm	Joint Cutter	24	1.57"	0.118"	0.472"	\$648.42
16" x 1"	100 m/s	4,800 rpm	Joint Cutter	28	1.57"	0.126"	0.472"	\$842.89



Universal Concrete Diamond Blades



Concrete and Masonry

Diamond cutting blade

DT 350 U EXTRA

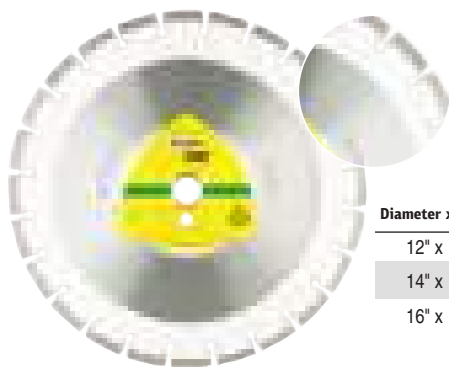

Also available in 20mm

Properties:	
Design	Laser Welded
Segmentation	Standard
Aggression	■■■■■□□
Service life	■■■□□□

Applications:	
Site construction materials	●
Concrete, universal	●
Landscape block/pavers	●

Advantages: Quality product with laser-welded standard segments for general construction site materials - Easy, low-vibration and fast cutting with very good service life - Optimum price-performance ratio

Diameter x Bore	Max Operating Speed	Max RPM's	Machine	Segment Dimensions			Price	
				Number	Length	Width		
12" x 1"	100 m/s	6,400 rpm	Gas Saw	18	1.57"	0.110"	0.394"	\$111.69
14" x 1"	100 m/s	5,500 rpm	Gas Saw	24	1.57"	0.126"	0.394"	\$114.70
16" x 1"	100 m/s	4,800 rpm	Gas Saw	24	1.57"	0.134"	0.394"	\$166.01

Concrete and Ductile

Diamond cutting blade

DT 600 U SUPRA

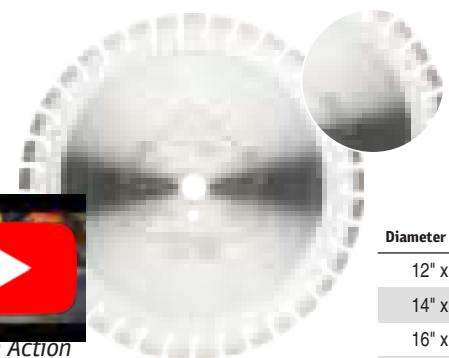

Also available in 20mm

Properties:	
Design	Laser welded
Segmentation	Short segments
Aggression	■■■■■□□
Service life	■■■■■□□

Applications:	
Concrete Curbs/Pipe	●
Cured concrete, reinforced	●
Landscape block/pavers	●
Limestone Concrete	●

Advantages: Diamond tool for construction material with good cutting properties - High cutting speed thanks to short segment design - Long service life thanks to the use of premium grade raw materials and diamonds

Diameter x Bore	Max Operating Speed	Max RPM's	Machine	Segment Dimensions			Price	
				Number	Length	Width		
12" x 1"	100 m/s	6,400 rpm	Gas Saw	32	0.94"	0.110"	0.394"	\$153.95
14" x 1"	100 m/s	5,500 rpm	Gas Saw	37	0.94"	0.118"	0.394"	\$186.84
16" x 1"	100 m/s	4,800 rpm	Gas Saw	43	0.94"	0.126"	0.394"	\$250.00
18" x 1"	100 m/s	4,300 rpm	Table	48	0.94"	0.126"	0.394"	\$334.52
20" x 1"	100 m/s	3,900 rpm	Table	54	0.94"	0.126"	0.394"	\$434.87



Concrete and Masonry

Diamond cutting blade

DT 900 U SPECIAL

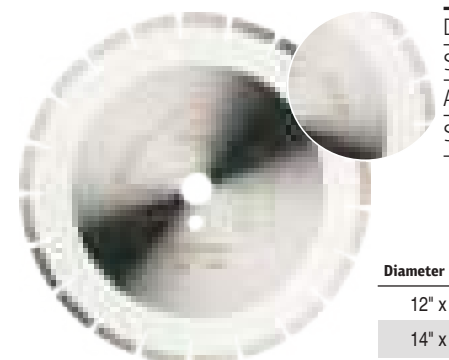

Also available in 20mm

Properties:	
Design	Laser welded
Segmentation	Turbo
Aggression	■■■■■□□
Service life	■■■■■□□

Applications:	
Construction materials	●
Masonry	●
Hardscape	●
Chalky sandstone	●
Hard stone	●
Granite	●

Advantages: Suitable for a wide range of applications - Ultra fast cutting speed - Special segment bond for long service life and clean cuts - Engineered for professional use

Diameter x Bore	Max Operating Speed	Max RPM's	Machine	Segment Dimensions			Price	
				Number	Length	Width		
12" x 1"	100 m/s	6,400 rpm	Table Saw	18	1.57"	0.110"	0.394"	\$226.09
14" x 1"	100 m/s	5,500 rpm	Table Saw	21	1.57"	0.118"	0.394"	\$274.39
16" x 1"	100 m/s	4,800 rpm	Table Saw	24	1.57"	0.126"	0.394"	\$367.12
18" x 1"	100 m/s	4,300 rpm	Table Saw	26	1.57"	0.142"	0.394"	\$418.04
20" x 1"	100 m/s	3,900 rpm	Table Saw	30	1.57"	0.146"	0.394"	\$501.78

Angle Grinder Concrete Combo



Concrete and Masonry

Diamond cutting blade

DT 350 U EXTRA

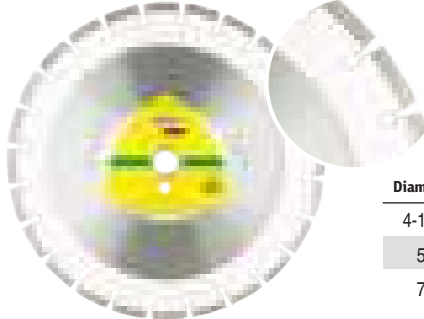

Properties:

Design	Laser Welded
Segmentation	Standard
Aggression	■■■■■□□
Service life	■■■□□□□

Applications:

- Site construction materials ●
- Concrete, universal ●
- Landscape block/pavers ●

Advantages: Quality product with laser-welded standard segments for general construction site materials - Easy, low-vibration and fast cutting with very good service life - Optimum price-performance ratio

Segment Dimensions

Diameter x Bore	Max Operating Speed	Max RPM's	Machine	Number	Length	Width	Height	Price
4-1/2" x 7/8"	80 m/s	13,300 rpm	Angle Grinder	8	1.30"	0.094"	0.394"	\$34.50
5" x 7/8"	80 m/s	12,200 rpm	Angle Grinder	9	1.30"	0.094"	0.394"	\$37.38
7" x 7/8"	80 m/s	8,500 rpm	Angle Grinder	11	1.65"	0.102"	0.394"	\$56.06

Concrete and Masonry

Diamond cutting blade

DT 600 U SUPRA

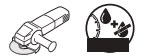
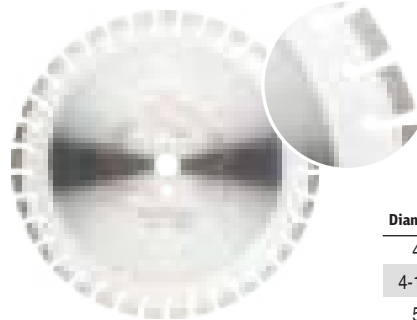

Properties:

Design	Laser Welded
Segmentation	Short segments
Aggression	■■■■■□□
Service life	■■■■■□□

Applications:

- Concrete Curbs/Pipe ●
- Cured concrete, reinforced ●
- Landscape block/pavers ●
- Limestone Concrete ●



• Short segments

Advantages: Concrete and block tool for construction material with good cutting properties - High cutting speed thanks to short segment design - Long service life thanks to the use of premium grade raw materials and diamonds

Segment Dimensions

Diameter x Bore	Max Operating Speed	Max RPM's	Machine	Number	Length	Width	Height	Price
4" x 5/8"	80 m/s	15,300 rpm	Angle Grinder	11	0.79"	0.094"	0.354"	\$43.06
4-1/2" x 7/8"	80 m/s	13,300 rpm	Angle Grinder	13	0.79"	0.094"	0.354"	\$47.11
5" x 7/8"	80 m/s	12,200 rpm	Angle Grinder	15	0.79"	0.094"	0.354"	\$53.44
6" x 7/8"	80 m/s	10,200 rpm	Angle Grinder	18	0.79"	0.094"	0.354"	\$65.49
7" x 7/8"	80 m/s	8,500 rpm	Angle Grinder	22	0.79"	0.094"	0.354"	\$80.30

Concrete and Masonry

Diamond cutting blade

DT 612 UT SUPRA

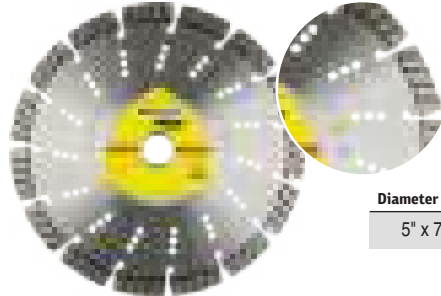

Properties:

Design	Laser welded
Segmentation	Turbo segments
Aggression	■■■■■□□
Service life	■■■■■□□

Applications:

- Concrete/reinforced ●



• Turbo segments

Advantages: High cutting rate on almost all hard materials.

Segment Dimensions

Diameter x Bore	Max Operating Speed	Max RPM's	Machine	Number	Length	Width	Height	Price
5" x 7/8"	80 m/s	12,200 rpm	Angle Grinder	9	1.30"	0.094"	0.472"	\$62.64

All Cut Metal

Diamond cutting blade

DT 600 ACM SUPRA



Properties:

Design	Vacuum-brazed
Segmentation	Standard
Aggression	■■■■■□□
Service life	■■■■■□□

Applications:

- Building Construction ●
- Gardening & Landscaping ●
- Paving Companies ●
- Road Companies ●
- Steel Construction ●

Advantages: Vacuum-brazed disc for almost all metals - No wear behavior as with conventional diamond cutting blades and therefore almost odorless and dirt-free - Extra thin blade for high cutting performance and aggressiveness.

Segment Dimensions

Diameter x Bore	Max Operating Speed	Max RPM's	Machine	Number	Length	Width	Height	Price
4-1/2" x 7/8"	80 m/s	13,300 rpm	Angle Grinder	8	1.65"	0.094"	0.071"	\$44.96
5" x 7/8"	80 m/s	12,200 rpm	Angle Grinder	10	1.42"	0.094"	0.071"	\$48.55
9" x 7/8"	80 m/s	6,600 rpm	Angle Grinder	16	1.65"	0.094"	0.071"	\$107.60



9" Battery Saw Blades



Concrete and Masonry

Diamond cutting blade

DT 350 U EXTRA



Properties:

Design	Laser Welded
Segmentation	Standard
Aggression	■■■■□□□□
Service life	■■■■□□□□

Applications:

- Site construction materials ●
- Concrete, universal ●
- Landscape block/pavers ●

Advantages: Quality product with laser-welded standard segments for general construction site materials - Easy, low-vibration and fast cutting with very good service life - Optimum price-performance ratio

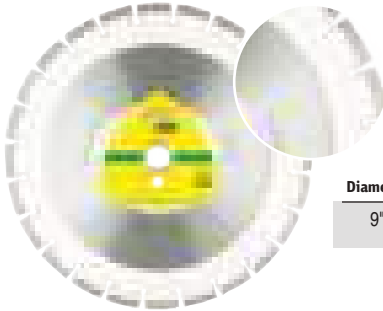

Segment Dimensions

Diameter x Bore	Max Operating Speed	Max RPM's	Machine	Segment Dimensions				Price
				Number	Length	Width	Height	
9" x 7/8"	80 m/s	6,600 rpm	Electric Cut-off	15	1.65"	0.102"	0.394"	\$84.82

Demolition

Diamond cutting blade

DT 900 B SPECIAL



Properties:

Design	Laser welded
Segmentation	Standard
Aggression	■■■■■■■■■■
Service life	■■■■■■■■■■

Applications:

- Cured concrete, reinforced ●
- Asphalt roads ●
- High aggregate concrete ●



• Titanium-coated diamonds

Advantages: High performance blade with ultra high cutting speed thanks to turbo segments - Specially engineered for effortless cutting through concrete - Further increased service life thanks to titanium-coated diamonds



Segment Dimensions

Diameter x Bore	Max Operating Speed	Max RPM's	Machine	Segment Dimensions				Price
				Number	Length	Width	Height	
9" x 7/8"	80 m/s	6,600 rpm	Electric Cut-off	15	1.65"	0.102"	0.472"	\$166.38

Demolition

Diamond cutting blade

DT 900 ACR SPECIAL



Properties:

Design	Vacuum-brazed
Segmentation	Narrow gullet
Aggression	■■■■■■■■■■
Service life	■■■■■■■■■■

Applications:

- Concrete, universal ●
- Asphalt ●
- Construction materials ●
- Glass ●
- Wood ●
- Rubber ●
- Metals ●
- Cast Iron ●
- Ductile Iron ●
- PVC/Plastic ●

Advantages: Vacuum-brazed diamond blade for easily cutting almost all material, wet or dry. Due to the complex manufacturing process, a particularly stable connection between the core and segmentation is achieved. This has a positive effect on lifetime and aggression. Allowing for aggressive cutting action on many different materials.



Segment Dimensions

Diameter x Bore	Max Operating Speed	Max RPM's	Machine	Segment Dimensions				Price
				Number	Length	Width	Height	
9" x 7/8"	80 m/s	6,600 rpm	Electric Cut-Off	12	2.20"	0.110"	0.394"	\$115.13

Diamond Cup Grinding Wheels



Concrete

Diamond cup grinding wheel

DS 300 B EXTRA



Properties:	
Design	Laser welded
Segmentation	Standard
Aggression	■■■■■□□
Service life	■■■■■□□

Applications:	
Concrete	●
Screed	●
Construction materials	●

Advantages: Double row cup grinding wheel with outstanding stock removal performance - High aggressiveness at low force requirements - Exceptional price-performance ratio

Also available in 5/8"-11



Segment Dimensions

Diameter x Bore	Max Operating Speed	Max RPM's	Machine	Number	Width	Height	Price
4" x 5/8"	80 m/s	15,300 rpm	Angle Grinder	14	0.276"	0.217"	\$64.25
4-1/2" x 7/8"	80 m/s	13,300 rpm	Angle Grinder	14	0.323"	0.217"	\$66.36
5" x 7/8"	80 m/s	12,200 rpm	Angle Grinder	18	0.276"	0.197"	\$60.89
7" x 7/8"	80 m/s	8,500 rpm	Angle Grinder	22	0.315"	0.197"	\$133.34

Concrete

Diamond cup grinding wheel

DS 600 B SUPRA



Properties:	
Design	Laser welded
Segmentation	Standard
Aggression	■■■■■■□
Service life	■■■■■■□

Applications:	
Concrete	●
Screed	●
Construction materials	●

Advantages: Double row cup grinding wheel for machining concrete and abrasive materials - Efficient dust extraction - Aggressive grinding performance - Long service life

Also available in 5/8"-11



Segment Dimensions

Diameter x Bore	Max Operating Speed	Max RPM's	Machine	Number	Width	Height	Price
4" x 5/8"	80 m/s	15,300 rpm	Angle Grinder	16	0.335"	0.217"	\$87.66
4-1/2" x 7/8"	80 m/s	13,300 rpm	Angle Grinder	16	0.323"	0.217"	\$115.59
5" x 7/8"	80 m/s	12,200 rpm	Angle Grinder	20	0.283"	0.217"	\$141.17
7" x 7/8"	80 m/s	8,500 rpm	Angle Grinder	24	0.315"	0.217"	\$200.72

Concrete and Stone

Diamond cup grinding wheel

DS 600 S SUPRA



Properties:	
Design	Laser welded
Segmentation	Standard
Aggression	■■■■■■□
Service life	■■■■■■□

Applications:	
Concrete	●
Firebrick	●
Natural stone	●
Masonry	●
Brickwork	●



Advantages: Excellent dust extraction thanks to specially designed (fan-shaped) opening - Low weight thanks to lightweight steel plate - Rugged performance and operation with minimum vibrations



Segment Dimensions

Diameter x Bore	Max Operating Speed	Max RPM's	Machine	Number	Width	Height	Price
4" x 5/8"	80 m/s	15,300 rpm	Angle Grinder	16	0.283"	0.217"	\$137.02
4-1/2" x 7/8"	80 m/s	13,300 rpm	Angle Grinder	16	0.283"	0.217"	\$143.06
5" x 7/8"	80 m/s	12,200 rpm	Angle Grinder	16	0.283"	0.217"	\$162.68
7" x 7/8"	80 m/s	8,500 rpm	Angle Grinder	24	0.307"	0.217"	\$248.40



Specialty Diamond Blades

Refractory & Clinker

Diamond cutting blade

DT 900 K SPECIAL

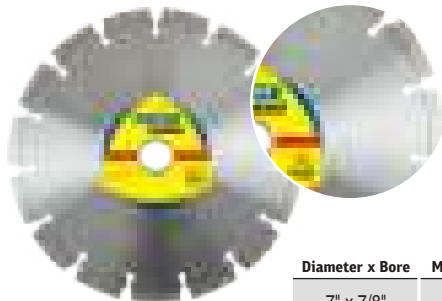

Properties:

Design	Laser welded
Segmentation	Standard
Aggression	■ ■ ■ ■ ■ □ □ □
Service life	■ ■ ■ ■ ■ □ □ □

Applications:

Clinker	●
Concrete products	○
Construction materials	○

Advantages: Exceptional cutting performance - Outstanding service life - Narrow gullet for smooth cutting and clean cutting edges - Particularly well suited for clinker of all degrees of hardness

Diameter x Bore	Max Operating Speed	Max RPM's	Machine	Segment Dimensions				Price
				Number	Length	Width	Height	
7" x 7/8"	80 m/s	8,500 rpm	Angle Grinder	11	1.65"	0.102"	0.472"	\$384.49

Tuck-Pointing

Diamond cutting blade

DN 300 U EXTRA



Properties:

Design	Sintered
Segmentation	Continuous rim
Aggression	■ ■ ■ ■ ■ □ □ □
Service life	■ ■ ■ ■ ■ □ □ □

Applications:

Mortar joints	●
Plaster	●
Aerated concrete	●

Advantages: Sandwich blade construction provides for 1/4" thick cut, ideal for removing mortar from bricks, good price for performance

Diameter x Bore	Max Operating Speed	Max RPM's	Machine	Segment Dimensions				Price
				Number	Length	Width	Height	
4-1/2" x 7/8"	80 m/s	13,300 rpm	Angle Grinder	8	1.65"	0.250"	0.433"	\$64.15

Crack Chasing

Diamond cutting blade

DN 600 UV SUPRA

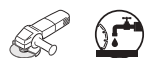

Properties:

Design	Sintered
Segmentation	V-shaped
Aggression	■ ■ ■ ■ ■ □ □ □
Service life	■ ■ ■ ■ ■ □ □ □

Applications:

Concrete Repair	●
-----------------	---

Advantages: 3/8" thick V-shaped segments allow for fast removal from concrete cracks

Diameter x Bore	Max Operating Speed	Max RPM's	Machine	Segment Dimensions				Price
				Number	Length	Width	Height	
4-1/2" x 7/8"	80 m/s	13,300 rpm	Angle Grinder	8	1.65"	0.250"	0.433"	\$128.28
4-1/2" x 5/8"-11	80 m/s	13,300 rpm	Angle Grinder	8	1.26"	0.375"	0.512"	\$147.90

Speciality Diamond Blades

Tiles

Diamond cutting blade

DT 600 P SUPRA

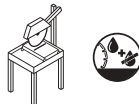
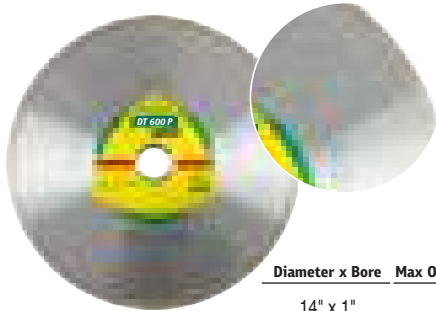

Properties:

Design	Sintered
Segmentation	Continuous rim
Aggression	■■■■■■■□
Service life	■■■■□□□□

Applications:

Stove tiles	●
Stoneware	●
Masonry/Brickwork	●

Advantages: Fast and clean cutting of hard and brittle porcelain tiles

Diameter x Bore	Max Operating Speed	Max RPM's	Machine	Segment Dimensions				
				Number	Length	Width	Height	Price
14" x 1"	100 m/s	5,500 rpm	Table/Masonry Saw	Continuous	Continuous	0.080"	7"	\$165.29

Tiles

Diamond cutting blade

DT 900 P SUPRA

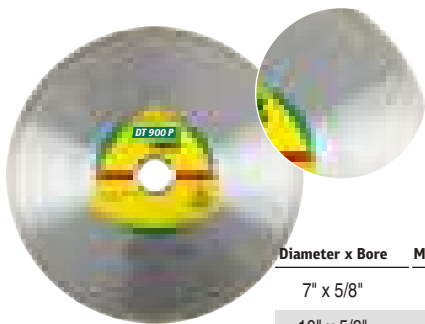

Properties:

Design	Sintered
Segmentation	Continuous rim
Aggression	■■■□□□□□
Service life	■■■■■■■□

Applications:

Stove tiles	●
Firebrick	●
Granite	●

Advantages: Fast and clean cutting of hard and brittle porcelain tiles

Diameter x Bore	Max Operating Speed	Max RPM's	Machine	Segment Dimensions				
				Number	Length	Width	Height	Price
7" x 5/8"	80 m/s	8,500 rpm	Table/Masonry Saw	Continuous	Continuous	0.060"	7"	\$124.51
10" x 5/8"	80 m/s	7,500 rpm	Table/Masonry Saw	Continuous	Continuous	0.060"	7"	\$143.38
12" x 5/8"	80 m/s	6,500 rpm	Table/Masonry Saw	Continuous	Continuous	0.060"	7"	\$188.65
14" x 5/8"	80 m/s	5,500 rpm	Table/Masonry Saw	Continuous	Continuous	0.060"	7"	\$265.91

DT 900 ACR All Cut Rescue

Also available in 20mm



Advantages

Vacuum-brazed diamond blade for easily cutting almost all material, wet or dry.

Due to the complex manufacturing process, a particularly stable connection between the core and segmentation is achieved.

This has a positive effect on lifetime and aggression. Allowing for aggressive cutting action on many different materials.



Properties

Design	Vacuum-brazed
Segmentation	Narrow gullet
Aggression	■■■■■■■■■
Service life	■■■■■■■■■

Applications

Concrete, universal	●	Wood	●	Cast Iron	●
Asphalt	●	Rubber	●	Ductile Iron	●
Construction materials	●	Metals	●	PVC/Plastic	●
Glass	●				

Diameter x Bore	Max Operating Speed	Max RPM's	Machine	Segment Dimensions				
				Number	Length	Width	Height	Price
9" x 7/8"	80 m/s	6,300 rpm	Electric Cut-off	12	2.20"	0.110"	0.394"	\$115.13
12" x 1"	100 m/s	6,400 rpm	Gas Saw	16	2.25"	0.122"	0.236"	\$232.58
14" x 1"	100 m/s	5,500 rpm	Gas Saw	20	2.09"	0.122"	0.236"	\$299.03



DIAMOND BLADES

Aggregate Classification Map of the United States

■ SOFT
 ■ MEDIUM SOFT
 ■ MEDIUM
 ■ MEDIUM HARD
 ■ HARD

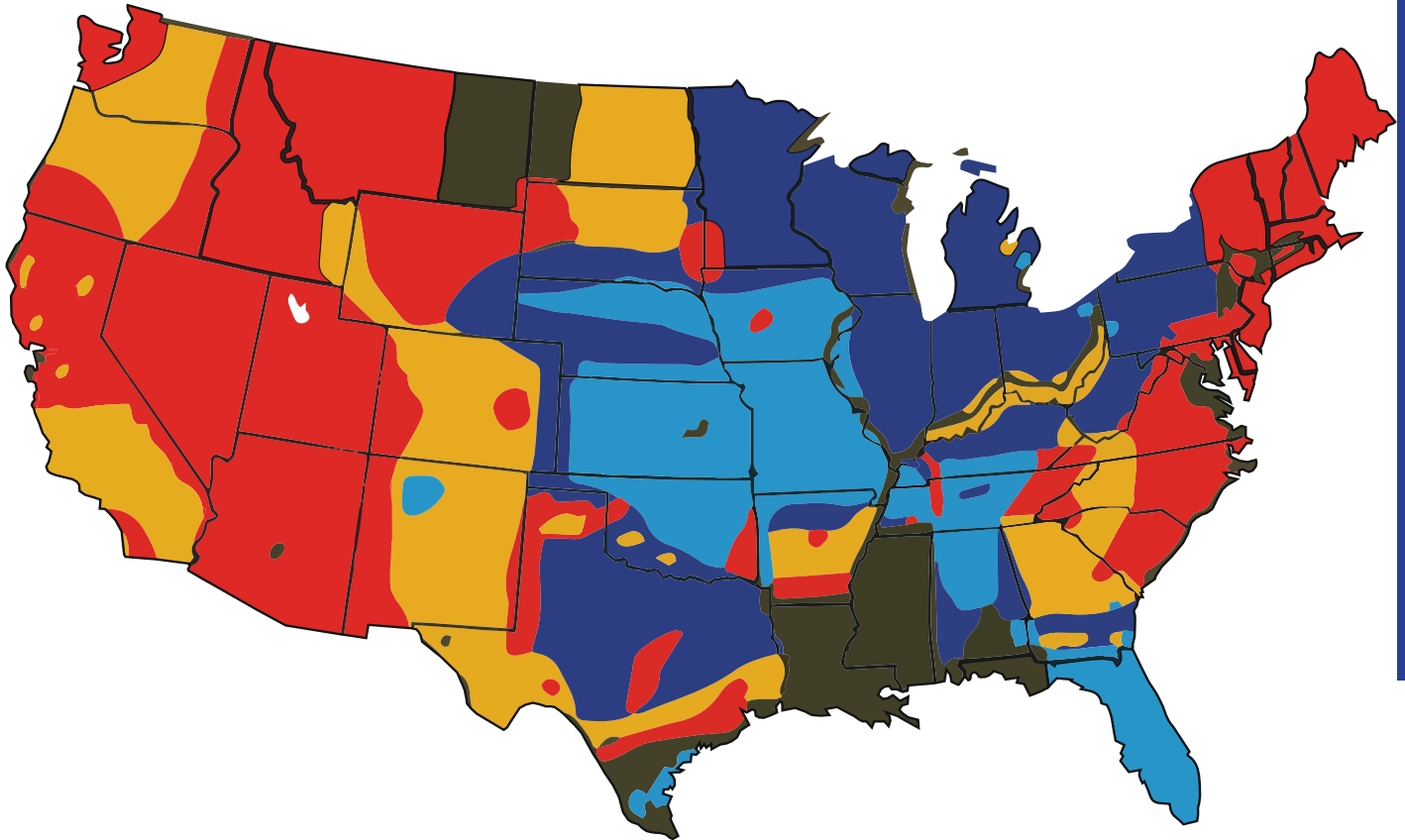























Based on your location and aggregate composition, KLINGSPOR's recommended blade types in 12" diameter and larger, are listed below:

Color Range	Aggregate Materials	Recommended Blade Types
SOFT	<ul style="list-style-type: none"> • SOFT LIMESTONE • SANDSTONE • DOLOMITE LIMESTONE • SILICEOUS • SOFT SHELL 	DT 350 Series
MEDIUM SOFT	<ul style="list-style-type: none"> • PIT GRAVEL • LIMESTONE • DOLOMITE 	DT 600, DT 602, and DT 612 series
MEDIUM	<ul style="list-style-type: none"> • MEDIUM HARD ROCK RIVER GRAVEL • MEDIUM TRAPROCK • DECOMPOSED GRANITE • MEDIUM CRUSHED GRAVEL 	DT 600, DT 602, and DT 612 Series
MEDIUM HARD	<ul style="list-style-type: none"> • GRANITE • SLATE • TRAPROCK • BASALT • QUARTZITE 	DT 900, DT 902, and DT 910 Series
HARD	<ul style="list-style-type: none"> • HARD CHERT • HARD QUARTZ • FLINT ROCK • HARD RIVER ROCK 	DT 900, DT 902, and DT 910 Series

Application	Material	Product Characteristics	Product
 <p data-bbox="105 527 435 590">  Cutting of concrete and general construction material using petrol-powered cutters </p>	<p data-bbox="570 260 699 369">Building Site Construction Materials (Concrete / Block / Stone)</p> <p data-bbox="570 386 699 512">Street and Highway Construction Asphalt & Concrete</p>	<ul style="list-style-type: none"> <li data-bbox="737 142 1289 237">▶ Diamond cutting blade with an outstanding price-performance ratio. <li data-bbox="737 191 1289 237">▶ Cutting performance and service life improved 50% over similar priced, private labelled sintered blades. <hr/> <ul style="list-style-type: none"> <li data-bbox="737 264 1289 333">▶ Diamond cutting blade for demanding applications at the construction site (e.g. longer service life on reinforced concrete or hard materials) <li data-bbox="737 333 1289 359">▶ Steel core: Cooling bores for improved heat dissipation <hr/> <ul style="list-style-type: none"> <li data-bbox="737 386 1289 432">▶ High performance diamond cutting blade with high cutting speed thanks to turbo segments <li data-bbox="737 432 1289 457">▶ Additionally extended service life <li data-bbox="737 457 1289 483">▶ Titanium-coated diamonds <hr/> <ul style="list-style-type: none"> <li data-bbox="737 522 1289 569">▶ Special arrangement of the diamonds ensures a very high cutting speed and good service life <li data-bbox="737 569 1289 594">▶ Ideally suited for almost all construction materials 	 <p data-bbox="1304 233 1438 254">DT 350 BT EXTRA</p> <hr/>  <p data-bbox="1304 359 1438 380">DT 612 UT SUPRA</p> <hr/>  <p data-bbox="1304 485 1438 506">DT 900 B special</p> <hr/>  <p data-bbox="1304 611 1438 632">DT 900 UX special</p>
 <p data-bbox="105 978 521 1020">  Cutting of concrete and general construction material using petrol-powered cutters </p>	<p data-bbox="597 821 672 842">Asphalt</p>	<ul style="list-style-type: none"> <li data-bbox="737 632 1289 678">▶ High quality diamond cutting blade for cutting asphalt with a handheld gas saw. <li data-bbox="737 678 1289 724">▶ Inclined segments prevent undercutting of the steel core, while aiding the removal of cut asphalt from the kerf. <li data-bbox="737 724 1289 749">▶ Also suitable for green concrete <hr/> <ul style="list-style-type: none"> <li data-bbox="737 768 1289 814">▶ High quality diamond cutting blade for asphalt with first-rate cutting speed <li data-bbox="737 814 1289 840">▶ Segment: Laser welded, 10 mm, wide gullet <li data-bbox="737 840 1289 886">▶ Safety segments prevent the undercutting-effect and provide optimum protection of the steel core <hr/> <ul style="list-style-type: none"> <li data-bbox="737 905 1289 951">▶ Premium-quality professional blade for asphalt; also suitable for green concrete and screed <li data-bbox="737 951 1289 976">▶ Segment: Laser welded, 12 mm, wide gullet <li data-bbox="737 976 1289 1022">▶ Safety segments prevent the undercutting-effect and provide optimum protection of the steel core 	 <p data-bbox="1304 737 1438 758">DT 350 A EXTRA</p> <hr/>  <p data-bbox="1304 863 1438 884">DT 602 A SUPRA</p> <hr/>  <p data-bbox="1304 1010 1438 1031">DT 902 A SPECIAL</p>
 <p data-bbox="105 1392 496 1434">  Cutting of Utility Construction Materials with a Hand Held Gas Saw. </p>	<p data-bbox="597 1241 672 1287">Premium Concrete</p>	<ul style="list-style-type: none"> <li data-bbox="737 1062 1289 1087">▶ First-rate cutting performance <li data-bbox="737 1087 1289 1113">▶ Fast cutting speed <li data-bbox="737 1113 1289 1138">▶ Particularly well suited for concrete with medium reinforcement <li data-bbox="737 1138 1289 1163">▶ Suitable for use on electric joint cutters <hr/> <ul style="list-style-type: none"> <li data-bbox="737 1213 1289 1239">▶ First-rate cutting performance <li data-bbox="737 1239 1289 1264">▶ Ultra fast cutting speed <li data-bbox="737 1264 1289 1289">▶ Suitable for concrete with strong reinforcement <hr/> <ul style="list-style-type: none"> <li data-bbox="737 1339 1289 1365">▶ Smooth and easy cutting performance <li data-bbox="737 1365 1289 1390">▶ 12 mm tall segments <li data-bbox="737 1390 1289 1415">▶ Protective segments shield the core <li data-bbox="737 1415 1289 1440">▶ Outstanding service life 	 <p data-bbox="1304 1157 1438 1178">DT 602 B SUPRA</p> <hr/>  <p data-bbox="1304 1297 1438 1318">DT 902 B SPECIAL</p> <hr/>  <p data-bbox="1304 1430 1438 1451">DT 910 BF SPECIAL</p>
	<p data-bbox="581 1707 699 1791">General Construction Materials/ Universal</p>	<ul style="list-style-type: none"> <li data-bbox="737 1497 1289 1543">▶ Diamond cutting blade with an outstanding price-performance ratio. <li data-bbox="737 1543 1289 1589">▶ Cutting performance and service life improved 50% over similar priced sintered blades. <hr/> <ul style="list-style-type: none"> <li data-bbox="737 1661 1289 1707">▶ Short segment technology for a high level of aggressiveness during cutting <li data-bbox="737 1707 1289 1753">▶ Exceptionally wide range of applications (including hard materials such as granite) <hr/> <ul style="list-style-type: none"> <li data-bbox="737 1803 1289 1850">▶ High performance diamond cutting blade with high cutting speed thanks to turbo segments <li data-bbox="737 1850 1289 1875">▶ Additionally extended service life <li data-bbox="737 1875 1289 1963">▶ Titanium-coated diamonds become exposed when cutting to increase aggression. Titanium coating also increases diamond adhesion in metal bond to allow 50% more diamond to be exposed before they release from bond. 	 <p data-bbox="1304 1577 1438 1598">DT 350 U EXTRA</p> <hr/>  <p data-bbox="1304 1745 1438 1766">DT 600 U SUPRA</p> <hr/>  <p data-bbox="1304 1917 1438 1938">DT 900 U special</p>



Application	Material	Product Characteristics	Product
 <p> Cutting of concrete and general construction material using petrol-powered cutters</p>	Concrete and Masonry for Angle Grinders	<ul style="list-style-type: none"> ▶ Quality product with laser-welded standard segments for general construction site materials ▶ Easy, low-vibration and fast cutting with very good service life ▶ Optimum price-performance ratio 	 <p>DT 350 U EXTRA</p>
		<ul style="list-style-type: none"> ▶ Concrete and block tool for construction material with good cutting properties ▶ High cutting speed thanks to short segment design ▶ Long service life thanks to the use of premium grade raw materials and diamonds 	 <p>DT 600 U SUPRA</p>
		<ul style="list-style-type: none"> ▶ High Cutting Speed Due To Turbo Segments ▶ For use on almost all hard materials ▶ Exceptionally long service life 	 <p>DT 612 UT SUPRA</p>
 <p> Cutting of concrete and general construction material using petrol-powered cutters</p>	Concrete and general construction material	<ul style="list-style-type: none"> ▶ Diamond cutting blade with an outstanding price-performance ratio ▶ Cutting performance and service life improved 50% over sintered diamond blades ▶ Low Vibration with Fast cutting edges 	 <p>DT 350 U EXTRA</p>
		<ul style="list-style-type: none"> ▶ Short segment technology for a high level of aggressiveness during cutting ▶ Exceptionally wide range of applications (including hard materials such as granite) ▶ Clean cutting edges 	 <p>DT 600 U Supra</p>
		<ul style="list-style-type: none"> ▶ High performance diamond cutting blade with high cutting speed ▶ Additionally extended service life ▶ Titanium-coated diamonds become exposed when cutting to increase aggression. Titanium coating also increases diamond adhesion in metal bond to allow 50% more diamond to be exposed before they release from bond. 	 <p>DT 900 B Special</p>
	Cup Grinding Wheels for General Construction Materials	<ul style="list-style-type: none"> ▶ Double row cup grinding wheel with outstanding stock removal performance ▶ High aggressiveness at low force requirements ▶ Exceptional price-performance ratio 	 <p>DS 300 B extra</p>
		<ul style="list-style-type: none"> ▶ Double row cup grinding wheel for machining concrete and abrasive materials ▶ Efficient dust extraction ▶ Aggressive grinding performance ▶ Long service life 	 <p>DS 600 B supra</p>
		<ul style="list-style-type: none"> ▶ Excellent dust extraction thanks to specially designed (fan-shaped) opening ▶ Low weight thanks to lightweight steel plate ▶ Rugged performance and operation with minimum vibrations 	 <p>DS 600 S supra</p>
 <p> Cutting of concrete and general construction material using petrol-powered cutters</p>	Specialty-Granite, Klinker, Tuck Point, Crack Chasing Porcelain Tiles	<ul style="list-style-type: none"> ▶ Premium-quality professional blade for asphalt; also suitable for green concrete and screed ▶ Safety segments prevent the undercutting-effect and provide optimum protection of the steel core 	 <p>DT 900 G</p>
		<ul style="list-style-type: none"> ▶ Special blade for asphalt and concrete, specially engineered for use on both materials, titanium-coated diamonds for excellent service life and superior aggressiveness ▶ Safety segments prevent the undercutting-effect and provide optimum protection of the steel core 	 <p>DT 900 K SPECIAL</p>
		<ul style="list-style-type: none"> ▶ High quality diamond cutting blade for asphalt with first-rate cutting speed ▶ Safety segments prevent the undercutting-effect and provide optimum protection of the steel core 	 <p>DN 300 U</p>
		<ul style="list-style-type: none"> ▶ High quality diamond cutting blade for cutting asphalt with a handheld gas saw. ▶ Inclined segments prevent undercutting of the steel core, while aiding the removal of cut asphalt from the kerf. ▶ Also suitable for green concrete 	 <p>DN 600 UV</p>
	All Cut Rescue	<ul style="list-style-type: none"> ▶ Vacuum-brazed diamond cut-off wheel ▶ Cuts concrete, steel, power cables, rebar, wood, rubber, bitumen, glass, GF plastic, PVC tubes and much more. ▶ Especially suited for rescue service. 	 <p>DT 900ACR SPECIAL</p>

KLINGSPOR Router Bits

KLINGSPOR is pleased to offer one of the finest lines of router bits and accessories available to the industrial market. These bits offer exceptional quality for long-lasting use and clean cuts.

What makes KLINGSPOR bits better than other bits on the market?

1. Thick carbide for extra sharpenings
2. Highest quality micrograin carbide
3. Made from solid alloy steel
4. Precision ground for proper balance at high RPM's
5. High hook and relief angles for better chip ejection
6. Superior edge quality

All of these components add up to the best bits you can buy anywhere.

PRODUCT GUARANTEE

All KLINGSPOR bits are warranted to be free from defects in workmanship or materials. Warranty is void if tools are altered in any way. Always read and follow owner's safety manual of all power machinery before using bits. Always use eye protection while using this or any carbide cutting product. **WARNING:** Re-grinding of this product will produce dust of potentially hazardous ingredients.

WARNING: KLINGSPOR products can expose you to chemicals including lead and/or cobalt, which are known to the State of California to cause cancer and birth defects or other reproductive harm. For more information go to <http://www.P65Warnings.ca.gov>.

WARNING: Drilling, sanding or machining wood products can expose you to wood dust, a substance known to the State of California to cause cancer. Avoid inhaling wood dust or use a mask or other safeguards for personal protection. For more information go to <http://www.P65Warnings.ca.gov>.

*Pay attention to the special use section throughout the catalog as that will denote specific uses of certain bits and direct replacements.



SPIRAL BITS

ADVANTAGES

- Very clean cut
- More cutter in wood means less vibration
- Better plunge-cutting
- Can be used on more machinery (CNC, Table, & hand router)
- Direct chips up or down
- Longer edgewear
- Solid carbide instead of tipped

DISADVANTAGES

- Limited lengths and diameters
- Can be somewhat risky to use as they are less flexible

STRAIGHT BITS

ADVANTAGES

- Wide variety of lengths and diameters
- Less expensive
- Greater ability to resharpen

DISADVANTAGE

- Plunge-cutting requires more effort and skill



SIGN MAKING / CNC



BALLNOSE SPIRAL

The upcut ballnose spiral bit is good for blind holes where you want the chips to be removed up and out of the hole. The "ballnose" is beneficial on CNC milling applications where 3D routing or carving is required, or for routing slots on inside corners with a radius, concave geometry.

- Precision 2D and 3D large scale carving
- Dimensional signage
- 3D millwork
- 2D and 3D contouring, profiling, modeling and pattern making for cabinetry, sign making, furniture making and jewelry mold making
- Compatible with CarveWright™ and CompuCarve woodworking systems
- Perfect for model-makers on large 3D milling profiles in abrasive EPS foam and other materials

Part #	Radius	Cut Diameter	Cutting Length	Shank	Overall Length	Price
SC64	1/32"	1/16"	3/4"	1/4"	2-1/2"	\$107.01
SC66	1/16"	1/8"	3/4"	1/4"	2-1/2"	\$107.01
RU1800RN	3/32"	3/16"	3/4"	1/4"	2-1/2"	\$55.48
RU2075RN	1/8"	1/4"	3/4"	1/4"	2-1/2"	\$51.52
RU5125RN	1/4"	1/2"	1-1/4"	1/2"	3"	\$206.12
RU5200RN	1/4"	1/2"	2"	1/2"	4"	\$213.37



V GROOVE

V Groove bits are available in a variety of angles. They cut deep or shallow "V" grooves. These bits are great for sign making or for adding decorative accents to furniture and plaques. Carbide tipped. Two-wing cutter.

Part Number	Cutting Diameter	Point Length	Angle	Overall Length	Price
1/4" SHANK					
sc 1500	1/4"	1/8"	90°	1-1/2"	\$36.15
1501	3/8"	3/16"	90°	1-7/8"	\$42.66
1502	1/2"	1/4"	90°	1-7/8"	\$43.87
sc 1540	1/4"	7/32"	60°	1-1/2"	\$36.15
* sc 1541	1/4"	7/32"	60°	2"	\$43.28
1550	1/2"	7/16"	60°	2"	\$52.30
1/2" SHANK					
1503	1/2"	1/4"	90°	2"	\$52.30
1504	3/4"	3/8"	90°	2-1/4"	\$98.44
1506	1"	1/2"	90°	2-1/4"	\$109.38
1508	1-1/2"	3/4"	90°	2-5/8"	\$154.56
1560	1/2"	7/16"	60°	2-1/4"	\$54.70
1/2" SHANK					
15-238	1-1/4"	1/2"	110°	2-3/16"	\$222.55
15-240	1-1/4"	1/4"	130°	2-3/16"	\$222.55
15-241	1-1/4"	3/16"	150°	2-3/16"	\$246.59
1508-91Q	1-1/2"	3/4"	91°	2-1/2"	\$200.03

sc - Solid Carbide Not for miter folding.
* #1541 features three flutes for improved veining

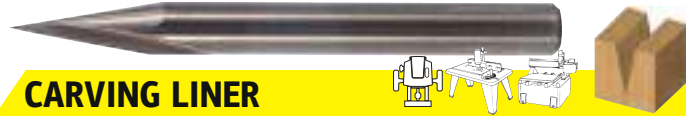

CARVING LINER

Carving Liner is specially designed for producing extra fine vein point for carving or lettering details. Due to the delicate nature of the profile great care should be used when running this bit. Point Length refers to the depth of cut from the corner of the shoulder to the bit tip. Solid carbide. Single fluted.

Part Number	Angle	Cutting Length	Shank Diameter	Overall Length	Price
SC50	10.5°	5/8"	1/4"	2-1/2"	\$59.45



ROUND NOSE

With Bearing Guide The addition of a shank mounted bearing extends the use of our round nose bits in lettering, veining, or decorative cuts when following a template.

Part Number	Radius	Cutting Diameter	Cutting Length	Bearing Number	Price
1/4" SHANK					
1404B	1/4"	1/2"	5/8"	B9	\$70.86
1405B	5/16"	5/8"	3/8"	B6	\$70.86
1406B	3/8"	3/4"	7/16"	B4	\$70.86



O-FLUTE SPIRAL BITS

Up Cut or Down Cut Solid Carbide - Slow Spiral
Used primarily for routing plastics
O-flute bits (straight or spiral) are ideal for working with plastics, thin aluminum (ACM), other soft metals, and starboard. The spiral O-flute evacuates shavings much more efficiently than the straight version. RU2074A has a special High polish grind applied for extra life and performance.

Up Cut Part #	Down Cut Part #	Cutting Diameter	Cutting Length	Shank Diameter	Overall Length	Price
SINGLE FLUTE						
RU1581A		1/8"	1/4"	1/4"	2"	\$55.84
RU1601A		1/8"	1/2"	1/4"	2-1/2"	\$55.84
RU1701A		5/32"	5/8"	1/4"	2-1/2"	\$55.84
RU1801A		3/16"	5/8"	1/4"	2-1/2"	\$55.84
RU2074A	RD2074A	1/4"	3/4"	1/4"	2-1/2"	\$53.49
RU2111A		1/4"	1-1/8"	1/4"	3"	\$57.76
RU4111A		3/8"	1-1/8"	3/8"	3"	\$77.02
RU5121A		1/2"	1-1/4"	1/2"	3"	\$165.60
RU5161A		1/2"	1-5/8"	1/2"	3-1/2"	\$177.16
RU5201A		1/2"	2"	1/2"	4"	\$188.71
DOUBLE FLUTE						
RU2076A	RD2076A	1/4"	3/4"	1/4"	2-1/2"	\$46.37



O - FLUTE STRAIGHT BITS

Solid Carbide - One Flute
Used primarily for routing plastics

Part Number	Cutting Diameter	Cutting Length	Shank Diameter	Overall Length	Price
SA1600	1/8"	3/8"	1/4"	2-1/2"	\$49.10
SA1700	5/32"	1/2"	1/4"	2-1/2"	\$59.45
SA1800	3/16"	1/2"	1/4"	2-1/2"	\$49.10
SA1900	7/32"	5/8"	1/4"	2-1/2"	\$59.45
SA2075	1/4"	3/4"	1/4"	2-1/2"	\$49.10
SA2100	1/4"	1"	1/4"	3-1/2"	\$61.82
SA4100	3/8"	1"	3/8"	3"	\$99.86

LH Rotation available by request.

ZIRKON (ZrN) COATED BITS

Item Numbers:

RU1601-Z	1/8"CD X 1/2" CL X 1/4" SH	\$114.13
RU1801-Z	3/16"CD X 7/8"CL X 1/4"SH	\$100.61
RU2074-Z	1/4"CD X 3/4"CL X 1/4"SH	\$96.84

Technical Information:

KLINGSPOR'S new Zirkon (ZrN) coating, added to an already high quality carbide results in an O-Flute bit that cuts cleaner and smoother than an ordinary carbide cutter. This results in faster speeds, higher feed rates, more production and a much longer tool life. The ZrN coating reduces friction and allows the bit to run much cooler, extending the life of the bit far beyond that of a standard carbide bit.

Features:

- Razor sharp cutting edge
- Effortless Chip Removal
- Help prevent chip re-welding
- Extended tool life
- Exceptional cut quality

Competitors:

- Vortex
- Onsrud
- Amana

Applications:

- Aluminum, Aluminum Alloys, Aluminum Composite Materials (ACM), Aluminum Composite Panels (ACP), Alupanel, Brass, Copper, Dibond, Durabond, Gold, Silver and Titanium Composite Material (TCM)

Target Audiences:

- Sign Shops
- Production Shops
- and many more

KROMA O-FLUTE BITS

Item Numbers:

RU1601-K	1/8" CD X 1/2" CL X 1/4" SH	\$89.41
RU1801-K	3/16" CD X 5/8" CL X 1/4" SH	\$96.84
RU2074-K	1/4" CD X 3/4"CL X 1/4" SH	\$93.07

Technical Information:

Adding to our KROMA offering, KLINGSPOR introduces our new Kroma O-Flute bits for plastic and composites. With a unique nanocomposite coating, these bits will provide 2-3 times the life of a standard carbide bit. The super hard shield created by the coating reduces friction and as a result there is much less heat in the cutting process. This allows for faster Feed and Speeds, a smoother cut and increased production.

Features:

- Micro-thin ceramic nACo coating means the tool's cutting edge will retain its sharpness.
- Reduced heat, which prevents the burning of both the tool and the material being cut.
- nACo coating provides around 4,500 Vickers for incredible hardness along the cutting edge.
- Increased life of 2-3 times that of an uncoated bit.
- Increased Feed/Speed rates over the competition.

Competitors:

- Vortex
- Onsrud
- Amana

Applications:

- Plastics
- Wood
- Foam

Target Audiences:

- Sign Shops
- Production Shops
- and more





STANDARD SPIRAL BITS



Up Cut or Down Cut Solid Carbide - Two Flute

Solid Carbide spiral bits are available in up, down, or up/down configuration, left or right (most will be right), in one, two or three flutes, and in 1/4", 5/16", 3/8", 1/2", 5/8" or 3/4" shank.

Upcut bits are good for blind holes where you want the chips to be removed up and out of the hole. The only problem with this is that same up cut motion can also cause the top surface to splinter up creating a chipped surface. If you were using the same bit on the edge of a piece of wood the bottom edge would be nice and clean because the "up" shearing action of the bit.

With a downcut bit you would have the opposite scenario from an upcut. The top would be clean and the bottom might be slightly splintered. Downcut bits are great for cutting dadoes and grooves. The top edges remain clean during the routing process. A slower feed rate is recommended when using a downcut spiral bit.

Up Cut Part #	Down Cut Part #	Cutting Diameter	Cutting Length	Overall Length	Price
---------------	-----------------	------------------	----------------	----------------	-------

1/4" SHANK

RU1600	RD1600	1/8"	1/2"	2"	\$46.37
RU1700	RD1700	5/32"	5/8"	2"	\$48.52
RU1800	RD1800	3/16"	3/4"	2-1/2"	\$46.37
RU1900	RD1900	7/32"	3/4"	2-1/2"	\$47.55
RU2075	RD2075	1/4"	3/4"	2-1/2"	\$44.61
RU2100	RD2100	1/4"	1"	2-1/2"	\$46.37

5/16" SHANK

RU3100	RD3100	5/16"	1"	2-1/2"	\$76.09
--------	--------	-------	----	--------	---------

3/8" SHANK

RU4075	RD4075	3/8"	3/4"	2-1/2"	\$71.34
RU4100	RD4100	3/8"	1"	2-1/2"	\$78.47
RU4125	RD4125	3/8"	1-1/4"	3"	\$83.22
*HU4125	*HD4125	3/8"	1-1/4"	3"	\$86.66

1/2" SHANK

RU4675	RD4675	1/4"	3/4"	3"	\$63.02
RU4700	RD4700	1/4"	1"	3-1/4"	\$67.76
RU4800	RD4800	9/32"	1"	3"	\$164.07
RU4850	RD4850	5/16"	1"	3"	\$124.84
RU4875	RD4875	3/8"	3/4"	3"	\$117.71
RU4900	RD4900	3/8"	1-1/4"	3"	\$124.84
RU4950	RD4950	7/16"	1-1/4"	3"	\$123.64
RU5100	RD5100	1/2"	1"	3"	\$111.75
*RU5125	RD5125	1/2"	1-1/4"	3"	\$117.71
*HU5125	*HD5125	1/2"	1-1/4"	3"	\$129.01
RU5150	RD5150	1/2"	1-1/2"	3-1/2"	\$126.02
*RU5200	RD5200	1/2"	2"	4"	\$154.56

5/8" SHANK

RU6150	RD6150	5/8"	1-1/2"	3-1/2"	\$273.46
RU6200	RD6200	5/8"	2"	4"	\$294.85

3/4" SHANK

RU7150	RD7150	3/4"	1-1/2"	4"	\$275.84
RU7200	RD7200	3/4"	2"	4"	\$297.23
RU7300	RD7300	3/4"	3"	5"	\$404.22
RU7306	RD7306	3/4"	3"	6"	\$439.89

* Ballnose available • HU/HD = Hard Carbide

SOLID CARBIDE SPIRAL



CHIPBREAKER SPIRAL BITS



Up Cut or Down Cut Solid Carbide - Two Flute

Chipbreaker Spiral bits are the same as a standard up or down spiral, but they are designed to break up the chips as the bit cuts the wood.

Up Cut Part #	Down Cut Part #	Cutting Diameter	Cutting Length	Overall Length	Price
1/2" SHANK					
RU5125CB	RD5125CB	1/2"	1-1/4"	3"	\$147.44
RU5150CB	RD5150CB	1/2"	1-1/2"	3-1/2"	\$154.56
RU5200CB	RD5200CB	1/2"	2"	4"	\$183.09

The above items are available from stock with chipbreakers. Chipbreakers can be added to any Spiral Bits by request.



FLUSH TRIM SPIRAL BITS



These spiral bits offer State-of-the-Art results in Flush trimming. Our 1/4" diameter tools are great for small inside corners. Try our 1/8" diameter for extremely sharp corners. The 1/8" bit uses a solid pilot. All others feature a double ball bearing guide. Available in your choice of Up Cut, Down Cut, or an Up/Down Combination. Flush trim spirals are great for following a pattern or template. They have a heavy duty bearing on the end and leave the edge much smoother than the straight bit counterpart due to having a cutting surface in the material at all times.

Up Cut Part #	Down Cut Part #	Cutting Diameter	Cutting Length	Overall Length	Price
---------------	-----------------	------------------	----------------	----------------	-------

1/4" SHANK

RFT1600	RFTD1600	1/8"	3/8"	2"	\$85.61
RFT2100	RFTD2100	1/4"	1"	3"	\$95.11

1/2" SHANK

RFT5125	RFTD5125	1/2"	1-1/4"	3-3/4"	\$187.84
RFT5200	RFTD5200	1/2"	2"	4-3/4"	\$223.51

Uses LC-125 Lock Collar



UDP = Pattern
UDC = Combo top/bottom
UDFT = Flush Trim



FLUSH TRIM UP/DOWN CUT SPIRAL



Up/Down Cut (2+2 Compression) Solid Carbide - Two Flute

Up Cut Part #	Down Cut Part #	Cutting Diameter	Cutting Length	Overall Length	Price
UDFT5152	1/2"	1-1/2"	1/2"	4-1/4"	\$280.58
*UDP9112	7/8"	1-1/8"	1/2"	4"	\$375.31
*UDC9112	7/8"	1-1/8"	1/2"	4"	\$375.31
*UDFT9112	7/8"	1-1/8"	1/2"	4"	\$350.19

* Solid carbide spiral brazed to a steel shank

SOLID CARBIDE SPIRALS



LEFT HAND SPIRAL BITS

Up Cut or Down Cut Solid Carbide - Two Flute

Up Cut Part #	Down Cut Part #	Cutting Diameter	Cutting Length	Overall Length	Price
1/4" SHANK					
LU1600	LD1600	1/8"	1/2"	2"	\$57.07
LU1800	LD1800	3/16"	3/4"	2"	\$57.07
LU2100	LD2100	1/4"	1"	2-1/2"	\$53.50
5/16" SHANK					
LU3100	LD3100	5/16"	1"	3"	\$104.63
3/8" SHANK					
LU4100	LD4100	3/8"	1"	3"	\$104.63
1/2" SHANK					
LU5125	LD5125	1/2"	1-1/4"	3"	\$133.16
LU5200	LD5200	1/2"	2"	4"	\$190.22
5/8" SHANK					
LU6200	LD6200	5/8"	2"	4"	\$518.37
3/4" SHANK					
LU7200	LD7200	3/4"	2"	4"	\$416.12



ROUGHING SPIRAL BITS

(Hoggers) Up Cut or Down Cut Solid Carbide - Three Flute

Roughing Spiral bits are the go to for material removal. They are known as the "hoggers". The edges have serrations milled into them to break up the chips into smaller pieces and really move some material fast when cutting.

Up Cut Part #	Down Cut Part #	Cutting Diameter	Cutting Length	Shank	Overall Length	Price
*RU4000H		3/8"	1"	3/8"	2-1/2"	\$121.27
RU4100H	RD4100H	3/8"	1"	3/8"	3"	\$130.78
RU4125H	RD4125H	3/8"	1-1/4"	3/8"	3"	\$133.16
RU5125H	RD5125H	1/2"	1-1/4"	1/2"	3"	\$214.00
RU5162H	RD5162H	1/2"	1-5/8"	1/2"	3-1/2"	\$261.56
RU5218H	RD5218H	1/2"	2-3/16"	1/2"	4"	\$337.66
RU6200H	RD6200H	5/8"	2"	5/8"	4"	\$370.93
RU7200H	RD7200H	3/4"	2"	3/4"	4"	\$437.51
RU7325H	RD7325H	3/4"	3-1/4"	3/4"	6"	\$589.70

*For Castle & P-C Pocket Machines.



THREE FLUTE SPIRAL BITS

Up Cut or Down Cut Solid Carbide - Three Flute

Up Cut Part #	Down Cut Part #	Cutting Diameter	Cutting Length	Shank	Overall Length	Price
RU4125T	RD4125T	3/8"	1-1/4"	3/8"	3"	\$90.36
RU5125T	RD5125T	1/2"	1-1/4"	1/2"	3"	\$123.64
RU5200T	RD5200T	1/2"	2"	1/2"	4"	\$161.69
RU7200T	RD7200T	3/4"	2"	3/4"	4"	\$332.90

UP/DOWN CUT SPIRAL BITS

Compression Bits give you the best of both worlds. The part of the spiral bit closest to the tip has a 3/8" upcut and the part closest to the router is downcut. It compresses the chips to the center of the bit.

This is especially good for plywood, laminates, and MDF when you need the top and bottom edges clean. Choosing the right length of bit is important to match the thickness of material you are cutting, so both ends of the bit have room to work.

The "M" denotes that the bit has a mortise cut, which provides a 1/4" upcut before the downcut begins. This allows the cutter to create a shallower groove/dado cut for denser or easily chipped material.

"HC" denotes a super hard Carbide, which provides much longer life when used on laminates and melamine. Speeds & feed rates must be reduced when using these bits due to the brittleness of the harder carbide.

"K" refers to our nano coating technology which increases life and allows for increased feed rates on high production applications.



Up/Down Cut (1+1 Compression) Solid Carbide - Single Flute

Up Cut Part #	Down Cut Part #	Cutting Diameter	Cutting Length	Overall Length	Price
UD2100	1/4"	1"	1/4"	2-1/2"	\$85.61
UD4125	3/8"	1-1/4"	3/8"	3"	\$147.44
UD5150	1/2"	1-1/2"	1/2"	3-1/2"	\$209.26
UD5160	1/2"	1-5/8"	1/2"	3-1/2"	\$209.26

Up/Down Cut (2+2 Compression) Solid Carbide - Two Flute

Up Cut Part #	Down Cut Part #	Cutting Diameter	Cutting Length	Overall Length	Price
UD1602	1/8"	1/2"	1/4"	2-1/2"	\$75.02
UD2102	1/4"	1"	1/4"	2-1/2"	\$80.84
*UD4102M	3/8"	1"	3/8"	2-1/2"	\$137.92
UD4122	3/8"	1-1/4"	3/8"	3"	\$137.92
*UD4122M	3/8"	1-1/4"	3/8"	3"	\$147.44
†UD4122M-K	3/8"	1-1/4"	3/8"	3"	\$178.53
•HC4122M	3/8"	1-1/4"	3/8"	3"	\$154.05
UD5050	3/8"	1/2"	3/8"	3"	\$191.89
UD5122	1/2"	1-1/4"	1/2"	3"	\$178.35
*UD5122M	1/2"	1-1/4"	1/2"	3"	\$190.22
UD5152	1/2"	1-1/2"	1/2"	3-1/2"	\$194.99
UD5162	1/2"	1-5/8"	1/2"	3-1/2"	\$194.99
*UD5162M	1/2"	1-5/8"	1/2"	3-1/2"	\$206.86
UD5202	1/2"	2"	1/2"	4"	\$214.07
UD6152	5/8"	1-1/2"	5/8"	4"	\$399.48
UD7152	3/4"	1-1/2"	3/4"	4"	\$394.72
UD7202	3/4"	2"	3/4"	5"	\$466.04

Up/Down Cut (3+3 Compression) Solid Carbide - Three Flute

Up Cut Part #	Down Cut Part #	Cutting Diameter	Cutting Length	Overall Length	Price
*UD4123M	3/8"	1-1/4"	3/8"	3"	\$175.95
UD5123	1/2"	1-1/4"	1/2"	3"	\$209.26
*UD5123M	1/2"	1-1/4"	1/2"	3"	\$223.51
UD5143	1/2"	1-3/8"	1/2"	3-1/2"	\$228.27
UD5163	1/2"	1-5/8"	1/2"	3-1/2"	\$228.27
*UD5163M	1/2"	1-5/8"	1/2"	3-1/2"	\$242.55

* Mortise Style - These bits have a short 1/4" up-cut end flute. This allows down shear cutting action to the top edge during shallow cuts.

• Super Hard Carbide versions for use on melamine and for extra life.

† Nano coating for increased feed rates.



SLOW SPIRAL BITS

Up Cut or Down Cut Solid Carbide - Three Flute

Slow Spiral bits have less of a twist than the full spirals, which makes them ideal for use on hardwoods, solid surface, and hard plastics.

Up Cut Part #	Down Cut Part #	Cutting Diameter	Cutting Length	Shank	Overall Length	Price
RU4100S	RD4100S	3/8"	1"	3/8"	2-1/2"	\$99.86
RU5100S	RD5100S	1/2"	1"	1/2"	3"	\$128.40
RU5150S	RD5150S	1/2"	1-1/2"	1/2"	3-1/2"	\$142.66



“
Klingspor router bits are
made from C2 & C3 premium
Micro-Grain carbide. Some
of the best in the industry!
”



SOLID CARBIDE STRAIGHT BITS

Solid Carbide straight bits are popular simply due to price. The cutter doesn't stay sharp as long as the spiral versions.



Up Cut Part #	Down Cut Part #	Cutting Diameter	Cutting Length	Overall Length	Price
SINGLE FLUTE					
SC062	1/16"	3/16"	1/4"	1-1/2"	\$35.67
SC01	1/16"	5/16"	1/4"	1-1/2"	\$49.93
SC01A	3/32"	5/16"	1/4"	1-1/2"	\$49.93
SC02	1/8"	3/8"	1/4"	1-1/2"	\$32.98
SC03	5/32"	5/8"	1/4"	1-1/2"	\$36.62
SC04	3/16"	1/2"	1/4"	1-1/2"	\$36.38
SC05	7/32"	3/4"	1/4"	2"	\$40.18
SC06	1/4"	3/4"	1/4"	2"	\$43.09
SC07	1/4"	1"	1/4"	2-1/2"	\$48.52
SC08	1/4"	1"	1/4"	3"	\$57.79
SC17	5/16"	1"	5/16"	2-1/2"	\$76.09
DOUBLE FLUTE					
SC33	1/8"	1/4"	1/4"	2"	\$33.88
SC09	1/8"	3/8"	1/4"	1-1/2"	\$33.76
SC09A	1/8"	3/8"	1/4"	2"	\$35.67
SC156	5/32"	3/8"	1/4"	1-1/2"	\$34.72
SC10	5/32"	5/8"	1/4"	1-1/2"	\$35.74
SC10A	5/32"	5/8"	1/4"	2"	\$37.46
SC34	3/16"	3/8"	1/4"	2"	\$36.15
SC11	3/16"	1/2"	1/4"	1-1/2"	\$36.62
SC11A	3/16"	1/2"	1/4"	2"	\$38.53
SC12	3/16"	5/8"	1/4"	2"	\$39.95
SC13	7/32"/5.5mm	3/4"	1/4"	2"	\$41.59
SC35	1/4"	1/2"	1/4"	2"	\$40.82
SC14	1/4"	3/4"	1/4"	2"	\$42.81
SC15	1/4"	1"	1/4"	2-1/2"	\$51.76
SC16	1/4"	1"	1/4"	3"	\$61.20
SC18	5/16"	1"	5/16"	2-1/2"	\$77.09
SC19	3/8"	1"	3/8"	2-1/2"	\$80.84
SC19A	3/8"	1-1/4"	3/8"	3"	\$85.61
SC218	7/32"/5.5mm	3/4"	1/2"	2-3/4"	\$59.45
SC235	15/64"/6mm	3/4"	1/2"	2-3/4"	\$59.45
SC20	1/4"	3/4"	1/2"	2-3/4"	\$63.02
SC21	1/4"	1"	1/2"	3"	\$67.76
SC22	5/16"	1"	1/2"	3"	\$85.61
SC23	3/8"	1"	1/2"	3"	\$99.86
SC24	3/8"	1-1/4"	1/2"	3"	\$107.01
SC25	1/2"	1"	1/2"	3"	\$107.01
SC26	1/2"	1-1/4"	1/2"	3"	\$111.75
SC27	1/2"	1-1/2"	1/2"	3-1/2"	\$116.52

SOLID CARBIDE SPIRALS

Straight Carbide Tipped bits (left & right hand) are the standard in the woodworking industry and are an economical version of the spirals. They are offered in more sizes and cutting lengths than their spiral counterparts and available in 1/4", 3/8", and 1/2" shanks.



CNC ROUTER BITS

Straight Cut - Carbide Tipped

CNC Tools are designed to meet the severe applications of CNC routing. These tools offer superior performance over standard straight flute bits at the high feed rates commonly found on CNC routers. They also provide an economical alternative to the more expensive spiral bits. For the ultimate in CNC routing, choose from KLINGSPOR's wide selection of Solid Carbide Spiral Bits.

** Use on CNC Routers only.

Part Number	Cutting Diameter	Cutting Length	Overall Length	Price
1/2" SHANK • DOUBLE FLUTE				
C1067	1/2"	1-1/4"	2-7/8"	\$48.93
C1069	1/2"	1-1/2"	3-1/8"	\$53.84
C1072	1/2"	2"	4-1/8"	\$76.09
3/4" SHANK • DOUBLE FLUTE				
C7512	3/4"	1-1/4"	3"	\$70.16
C7515	3/4"	1-1/2"	3-1/4"	\$76.09
C7520	3/4"	2"	4"	\$90.36
C7525	3/4"	2-1/2"	4-1/2"	\$99.86

F - Supplied with Carbide Flat Bottom Boring Point

V - Supplied with Carbide Vee Bottom Boring Point



SOLID CARBIDE FIBERGLASS BITS

The Solid Carbide Fiberglass Bit looks a lot like a wood rasp, and that's pretty much what it is. Their material removing capacity is limited relative to other kinds of bits but they are great for finishing cuts. Since the feed rate needs to be a little slower they're gentle on the material and are often used with composites, PC board material, fiberglass, and other layered materials.

Part Number	Cutting Diameter	Cutting Length	Shank Diameter	Overall Length	Price
SC90	1/4"	3/4"	1/4"	2-1/2"	\$49.93
SC90V	1/4"	3/4"	1/4"	2-1/2"	\$52.30
SC91V	1/4"	1"	1/4"	3"	\$64.20

*Note - order SC90 for flat bottom plunge point
SC90V & SC91V are supplied with vee plunge point

SOLID CARBIDE



FLUSH & 7° BEVEL TRIM -



WITHOUT PILOT

Part Number	Cutting Length	Shank Diameter	Overall Length	Price
SC30	3/8"	1/4"	1-1/2"	\$27.35



HOLE & FLUSH TRIM



Part Number	Cutting Length	Shank Diameter	Overall Length	Price
SC31	3/8"	1/4"	2"	\$30.31



RIP & SLOTTING



Part Number	Cutting Length	Shank Diameter	Overall Length	Price
SC32	3/8"	1/4"	1-1/2"	\$29.73



FLAT BOTTOM VEINING

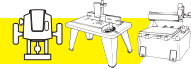

Part Number	Cutting Diameter	Cutting Length	Overall Length	Flutes	Price
1/4" SHANK - DOUBLE FLUTE					
SC33	1/8"	1/4"	2"	2	\$33.88
SC156	5/32"	3/8"	1-1/2"	2	\$34.72
SC34	3/16"	3/8"	2"	2	\$36.15
SC35	1/4"	1/2"	2"	2	\$40.82



ROUND BOTTOM VEINING



Part Number	Radius	Cutting Length	Shank Diameter	Overall Length	Price
1/4" SHANK - DOUBLE FLUTE					
SC39	1/16"	1/8"	1/4"	2"	\$41.38
SC40	3/32"	3/16"	3/8"	2"	\$40.18
SC41	1/8"	1/4"	1/2"	2"	\$39.51

LH Rotation available by request.

Solid Carbide flush / bevel trim bits work well, but do not have the bearing to follow the template. Instead, the solid end follows the template. This can create burning if a lubricant is not used. These are common in laminate countertop applications.

The 7 degree bevel bits allow for minimal filing of the edge once routed. This is a huge benefit for the end user as it saves them time, which is money.



STANDARD FLUSH TRIM - 1/4" CUT LENGTH

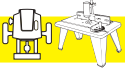

Part Number	Cutting Length	Shank Diameter	Overall Length	Price
SC28B	1/4"	1/4"	1-1/2"	\$22.59
SC28B-BLK	100 Pcs. - Bulk			\$1,764.85



FLUSH TRIM - 3/8" CUT LENGTH

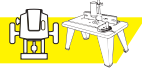

Part Number	Cutting Length	Shank Diameter	Overall Length	Price
SC28	3/8"	1/4"	1-1/2"	\$24.97
SC28-BLK	100 Pcs. - Bulk			\$1,893.44



FLUSH TRIM - DOUBLE END

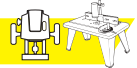

Part Number	Cutting Length	Shank Diameter	Overall Length	Price
SC28A	1/4"	1/4"	2"	\$37.46



1/8" PILOT

DADO TRIM - SMALL PILOT FOR DADO

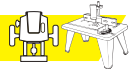

Part Number	Cutting Length	Shank Diameter	Overall Length	Price
SC28C	1/4"	1/4"	1-1/2"	\$22.59
SC28C-BLK	100 Pcs. - Bulk			\$1,764.85



7° BEVEL TRIM

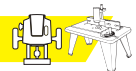

Part Number	Cutting Length	Shank Diameter	Overall Length	Price
SC29	1/4"	1/4"	1-1/2"	\$24.97
SC29-BLK	100 Pcs. - Bulk			\$1,584.15



7° BEVEL TRIM - DOUBLE END

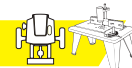

Part Number	Cutting Length	Shank Diameter	Overall Length	Price
SC29A	1/4"	1/4"	2"	\$40.43



CARBIDE TIPPED STRAIGHTS



1/2" SHANK STRAIGHT BITS



Part Number	Cutting Dia	Cutting Length	Overall Length	Special Use	Price
1/2" SHANK • SINGLE FLUTE					
1049	3/8"	1"	2-5/8"		\$35.55
1050	3/8"	1-1/4"	2-7/8"		\$38.96
1051	1/2"	3/4"	2-3/8"	Midwest Machine	\$34.47
1054	1/2"	1-1/2"	3-1/8"		\$38.64
1055	1/2"	2"	4-1/8"		\$46.37
1055A	1/2"	2-1/2"	4-3/8"		\$59.01
1/2" SHANK • DOUBLE FLUTE					
1058	1/4"	3/4"	2-3/8"	Incra™	\$42.09
1059	9/32"	3/4"	2-3/8"		\$42.09
1060	5/16"	1"	2-5/8"		\$43.37
1061	3/8"	3/4"	2-3/8"		\$37.21
1062	3/8"	1"	2-5/8"	Incra™	\$41.05
1063	3/8"	1-1/4"	2-7/8"		\$45.08
1065	7/16"	1-1/4"	2-7/8"		\$41.90
1065L	7/16"	1-1/4"	3-1/4"	Leigh #150	\$44.50
1065A	31/64"	1"	2-5/8"	Undersize Plywood Dado	\$39.00
1066	1/2"	1"	2-5/8"		\$39.00
1067	1/2"	1-1/4"	2-7/8"	Leigh #160	\$40.18
1067F	1/2"	1-1/4"	2-7/8"	Carbide Boring Point	\$58.62
1069	1/2"	1-1/2"	3-1/8"		\$43.28
1070	1/2"	1-1/2"	4-1/8"		\$48.85
1071	1/2"	2"	3-1/2"		\$59.63
1072	1/2"	2"	4-1/8"		\$61.06
1073	1/2"	2-1/2"	4-3/8"		\$79.22
1073-01	1/2"	2-1/2"	5-1/2"		\$85.61
1073-03	1/2"	2-1/2"	5-1/2"	Flat on shank	\$99.07
1074	17/32"	1-1/4"	2-7/8"		\$47.44
1075	9/16"	1-1/4"	3"		\$44.22
1075A	19/32"	3/4"	2-1/4"	Undersize Plywood Dado	\$46.51
1076	5/8"	1"	2-1/2"		\$42.33
1077	5/8"	1-1/4"	3"		\$44.22
1078	5/8"	1-1/2"	3"		\$47.44
1079	5/8"	2"	4"		\$74.38
1080	21/32"	1-1/4"	3"		\$53.08
1082	11/16"	1"	2-1/2"		\$47.44
1083	11/16"	1-1/4"	3"		\$49.70
1083A	23/32"	1"	2-1/2"	Undersize Plywood Dado	\$47.44
1302A	3/4"	5/8"	2-1/4"	Mortising	\$46.12
1084	3/4"	1"	2-3/4"		\$46.12
1085	3/4"	1-1/4"	3"		\$47.44
1085F	3/4"	1-1/4"	3"	Carbide Boring Point	\$67.53
1086	3/4"	1-1/2"	3-1/4"		\$53.73
1087	3/4"	2"	3-5/8"		\$74.19
1088	25/32"	1-1/4"	3"		\$51.00
1090	13/16"	1-1/4"	3"		\$53.50
1091	7/8"	1-1/4"	3"		\$53.50
1092	15/16"	1-1/4"	3"		\$61.82
1093	1"	1-1/4"	3"		\$59.26
1093F	1"	1-1/4"	3"	Carbide Boring Point	\$79.22
1094	1"	1-1/2"	3"		\$63.58
1095	1"	2"	3-3/4"		\$86.80
1096	1-1/8"	1-1/2"	3"		\$79.04
1304	1-1/4"	1/2"	2-1/8"	Mortising	\$55.29
1097	1-1/4"	1-1/2"	3"		\$76.09
1098	1-3/8"	1-1/4"	3"		\$89.17
1099	1-1/2"	1-1/4"	3"		\$94.16
1100	1-3/4"	1-1/4"	3"		\$135.54
1101	2"	1-1/4"	3"		\$144.81

STRAIGHT CUT CABINET DADO BITS



For Undersized Plywood

Straight cut cabinet dado bits are ideal for those using undersized plywood. They are also available in spiral geometry.

Part Number	Cutting Diameter	Plywood Size	Cutting Length	Overall Length	Price
1/4" SHANK • DOUBLE FLUTE					
sc SC13	7/32"	1/4"/5.5mm	3/4"	2"	\$41.59
1024A	31/64"	1/2"	3/4"	2-1/4"	\$42.81
1027A	19/32"	5/8"	3/4"	2-1/4"	\$42.81
1029A	23/32"	3/4"	3/4"	2-1/8"	\$48.89
1/2" SHANK • DOUBLE FLUTE					
sc SC218	7/32"	1/4"/5.5mm	3/4"	2-3/4"	\$59.45
sc SC235	15/64"	15/64"/6mm	3/4"	2-3/4"	\$59.45
1065A	31/64"	1/2"	1"	2-5/8"	\$39.00
1075A	19/32"	5/8"	3/4"	2-1/4"	\$46.51
1083A	23/32"	3/4"	1"	2-1/2"	\$47.44

sc - Solid Carbide



TEMPLATE BITS

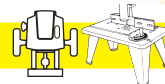

Ball Bearing Guide

Template bits have a top bearing for following a template that is on top of the work. Carbide tipped. Double flute.

Part Number	Cutting Diameter	Plywood Size	Cutting Length	Overall Length	Price
1/4" SHANK					
* 3000A	1/2"	1/8"	1-3/4"	B9	\$53.50
* 3000	1/2"	1/4"	1-7/8"	B9	\$51.12
3001	1/2"	1/2"	2"	B9	\$53.50
3002	1/2"	3/4"	2-1/4"	B9	\$55.88
3004	1/2"	1"	2-1/2"	B9	\$57.54
* 3006	5/8"	1/4"	1-3/4"	B6	\$55.88
K41	5/8"	1/2"	2-1/4"	B6	\$71.34
K43	5/8"	3/4"	2-1/2"	B6	\$76.09
3008	5/8"	1"	2-1/2"	B6	\$70.16
* 3010	3/4"	1/4"	1-3/4"	B4	\$55.88
3012	3/4"	3/4"	2-3/8"	B4	\$69.46
3014	3/4"	1"	2-5/8"	B4	\$71.21
3/8" SHANK					
3015	7/8"	1"	2-5/8"	B12	\$90.25
1/2" SHANK					
3016	1-1/8"	1"	3"	B11	\$90.25
3018	1-1/8"	1-1/2"	3-1/2"	B11	\$101.07
3019	1-1/8"	2"	4"	B11	\$130.78
*** 3020	3/4"	1"	2-3/4"	*** B19	\$76.09
*** 3021	3/4"	1-1/4"	3"	*** B19	\$80.84
*** 3022	3/4"	1-1/2"	3-1/4"	*** B19	\$89.17
3022A	7/8"	1-1/2"	3-1/2"	B13	\$89.17
*** 3023	3/4"	2"	3-5/8"	*** B19	\$109.38

* Dado Clean out bits. Use to Square the bottom of dado cuts made on a table saw.
 *** KLINGSPOR recommends using bits over 3/4" diameter in 1/2" shank whenever possible due to the fragile nature of the B19 bearing.

CARBIDE TIPPED STRAIGHTS



LEFT HAND - STRAIGHT CUT

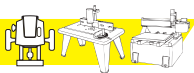

Part Number	Cutting Diameter	Cutting Length	Overall Length	Price
1/2" SHANK • DOUBLE FLUTE				
1066LH	1/2"	1"	2-5/8"	\$77.28
1069LH	1/2"	1-1/2"	3-1/8"	\$91.55
1072LH	1/2"	2"	4-1/8"	\$109.38
1085LH	3/4"	1-1/4"	3"	\$90.36
3/4" SHANK • DOUBLE FLUTE				
1105LH	3/4"	2"	5"	\$104.63

NOTE: Left Hand Spiral Bits also available,



3/8" SHANK STRAIGHT BITS

Part Number	Cutting Diameter	Cutting Length	Overall Length	Special Use	Price
3/8" SHANK • DOUBLE FLUTE					
1039	3/8"	1"	2-5/8"		\$41.05
1040	3/8"	1-1/4"	2-7/8"		\$43.75
1041	3/8"	1-1/4"	3-5/8"	Air Router	\$45.33
1043	1/2"	1"	2-1/2"		\$43.52
1045	7/8"	1"	2-1/2"		\$57.07



1/4" SHANK STRAIGHT BITS



Part Number	Cutting Diameter	Cutting Length	Overall Length	Special Use	Price
1/4" SHANK • SINGLE FLUTE					
For smaller sizes see solid carbide straight bits.					
1005	1/4"	1"	2-1/2"		\$29.30
1007	1/4"	1"	3-1/8"		\$29.96
1007A	1/4"	1"	3-1/4"	Air Router	\$32.09
1/4" SHANK • DOUBLE FLUTE					
1012	1/4"	1/2"	2"		\$33.76
1013	1/4"	3/4"	2-1/4"	Incra™	\$33.29
1014	1/4"	1"	2-1/2"		\$34.47
1016	1/4"	1"	3"		\$36.85
1016-01	1/4"	1"	3-1/4"	Air Router	\$39.00
1018	9/32"	1"	3"		\$39.00
1019	5/16"	1"	2-1/2"	OmniJig® #43300	\$37.10
1020	5/16"	1"	2-3/4"	Leigh #140	\$38.32
1020x8	5/16"	1"	2-3/4"	Leigh #140-8mm shank	\$45.15
1021	3/8"	3/4"	2-1/4"		\$37.10
1022	3/8"	1"	2-1/2"	Incra™	\$39.00
1023	3/8"	1-1/4"	2-3/4"		\$45.08
1023A	13/32"	1"	2-1/2"		\$41.38
1024	7/16"	1"	2-1/2"		\$42.56
1024A	31/64"	3/4"	2-1/4"	Undersize Plywood Dado	\$42.81
1025	1/2"	3/4"	2-1/4"		\$38.04
1026	1/2"	1"	2-1/2"	OmniJig® #43318	\$40.43
1027	9/16"	3/4"	2-1/4"		\$42.81
1027A	19/32"	3/4"	2-1/4"	Undersize Plywood Dado	\$42.81
1028	5/8"	3/4"	2-1/8"		\$42.70
1029	11/16"	3/4"	2-1/8"		\$48.89
1029A	23/32"	3/4"	2-1/8"	Undersize Plywood Dado	\$48.89
1030	3/4"	3/4"	2-1/8"		\$44.61
1031	3/4"	1"	2-5/8"		\$49.70
1033	1"	3/4"	2-1/8"		\$55.90
1303	1-1/4"	1/2"	2-1/8"	Mortising	\$63.84



WATCH
ROUTER BITS
IN ACTION



STAGGERTOOTH • MORTISE



STAGGERTOOTH BITS



Straight Flute Staggertooth Bits (straight & up/down) offer good chip deflection, but require a slower feed rate. The up/down version has an up shear on one side and a down shear on the other making them ideal for melamine, plywood, laminates, and solid surface.

Part Number	Cutting Diameter	Cutting Length	Overall Length	Price
1/2" SHANK				
1203	1/2"	2-1/8"	4"	\$55.88
1205	1/2"	2-5/8"	5-1/2"	\$133.16



MORTISE BITS



Part Number	Cutting Diameter	Cutting Length	Overall Length	Price
1/4" SHANK				
1300	1/2"	3/4"	2-1/8"	\$39.11
1301	5/8"	3/4"	2-1/8"	\$43.66
1302	3/4"	3/4"	2-1/8"	\$45.33
1303	1-1/4"	1/2"	2-1/8"	\$63.84
1/2" SHANK				
1302A	3/4"	5/8"	2-1/4"	\$46.12
1304	1-1/4"	1/2"	2-1/8"	\$55.29



*with HMA 1/2 only

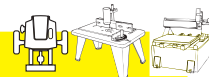

SCREW TYPE HELIX MORTISE

With Downshear - Cutter Only Mortise bits are for shallow recesses like in grooving out for a door hinge. They are available in standard and a screw type helix that threads onto an arbor.

Part Number	Cutting Diameter		Cutting Length	Overall Length	Price
	Fractional	Decimal			
13-500	1/2"	.500	5/8"	7/8"	\$54.81
13-515	33/64"	.515	5/8"	7/8"	\$54.81
13-531	17/32"	.531	5/8"	7/8"	\$54.81
13-562	9/16"	.562	5/8"	7/8"	\$54.81
13-625	5/8"	.625	5/8"	7/8"	\$54.81
13-640	41/64"	.640	5/8"	7/8"	\$54.81
13-656	21/32"	.656	5/8"	7/8"	\$57.54
13-687	11/16"	.687	5/8"	7/8"	\$57.54
13-719	23/32"	.719	5/8"	7/8"	\$57.54
13-750	3/4"	.750	5/8"	7/8"	\$57.54
13-765	49/64"	.765	5/8"	7/8"	\$57.54
13-781	25/32"	.781	5/8"	7/8"	\$57.54
13-875	7/8"	.875	5/8"	7/8"	\$62.30
13-1000	1"	1.000	1/2"	1/2"	\$62.30
13-1125	1-1/8"	1.125	1/2"	1/2"	\$62.30
13-1250	1-1/4"	1.250	1/2"	1/2"	\$62.30
* 13-1250A	1-1/4"	1.250	1/2"	1/2"	\$62.30

* 13-1250A supplied with 5/16"-24 threads. All others supplied with 1/4"-28 threads. Special Cutting Diameters Available by Special Order.



HELIX MORTISE ARBORS

Helix Mortise Arbors are for use with the "screw type helix mortise cutters". They are available in both 1/4" & 1/2" shank and 1/4"-28 and 5/16"-24 threads.

Part Number	Shank Diameter	Thread	Overall Length	Price
HMA-1/4	1/4"-28	1-3/4"		\$11.90
* HMA-1/2	1/2"	1-3/4"		\$11.90
** HMA-1/4A	5/16"-24	1-3/4"		\$11.90
*** HMA-1/2A	5/16"-24	1-3/4"		\$11.90

** Fits #13-1250A only



ROUND NOSE • HALF ROUND



BOWL & TRAY BITS

Bowl & Tray bits are used for dishing out and making flat bottomed grooves with curved edges. It is available with a top bearing (on two bits) for following a template. Carbide tipped. Two-wing cutter.

Part Number	Radius	Cutting Diameter	Cutting Length	Overall Length	Price
1/4" SHANK					
1370	1/8"	7/16"	5/16"	2-1/8"	\$57.07
1372	1/4"	3/4"	5/8"	2-3/8"	\$59.45
* 1372B	1/4"	3/4"	5/8"	2-3/8"	\$70.16
1/2" SHANK					
1374	1/4"	3/4"	5/8"	2-3/8"	\$59.24
1376	1/4"	1-1/4"	1/2"	2-1/4"	\$68.95
* 1376B	1/4"	1-1/4"	1/2"	2-1/4"	\$85.61

* Supplied with Bearing on Shank for Pattern Template Routing.



*with 1/2" shank only

ROUND NOSE (CORE BOX)

Round Nose bits make round bottomed grooves. They are very popular for fluting of moldings creating a trough around cutting boards and many other uses. Round nose bits are available standard and some are also available with a bearing. They may be commonly known as a "Core Box Bit" as well. Carbide tipped. Two-wing cutter.

Part Number	Radius	Cutting Diameter	Cutting Length	Overall Length	Price
1/4" SHANK					
sc SC39	1/16"	1/8"	1/4"	2"	\$41.37
sc SC40	3/32"	3/16"	3/8"	2"	\$40.18
sc SC41	1/8"	1/4"	1/2"	2"	\$39.51
1403	3/16"	3/8"	1/2"	2"	\$46.29
1404	1/4"	1/2"	5/8"	2-1/4"	\$55.78
1405	5/16"	5/8"	3/8"	2"	\$57.72
1406	3/8"	3/4"	7/16"	2"	\$58.83
1/2" SHANK					
1407	3/16"	3/8"	1"	2-5/8"	\$64.12
1408	1/4"	1/2"	1-1/4"	2-7/8"	\$67.62
1410	5/16"	5/8"	1-1/4"	2-7/8"	\$73.72
1411	3/8"	3/4"	1-1/4"	2-7/8"	\$84.41
1412	7/16"	7/8"	1-1/4"	2-7/8"	\$107.01
1413	1/2"	1"	1-1/4"	2-7/8"	\$109.38
1414	5/8"	1-1/4"	1-1/4"	3"	\$118.89
1415	3/4"	1-1/2"	1-1/4"	3"	\$154.56
1416	7/8"	1-3/4"	1-1/4"	3"	\$223.51
1417	1"	2"	1-1/4"	3"	\$235.40
3/4" SHANK					
1420	3/8"	3/4"	2"	4"	\$194.99

sc - Solid Carbide



ROUND NOSE

With Bearing Guide The addition of a shank mounted bearing extends the use of our round nose bits in lettering, veining, or decorative cuts when following a template.

Part Number	Radius	Cutting Diameter	Cutting Length	Bearing Number	Price
1/4" SHANK					
1404B	1/4"	1/2"	5/8"	B9	\$70.86
1405B	5/16"	5/8"	3/8"	B6	\$70.86
1406B	3/8"	3/4"	7/16"	B4	\$70.86

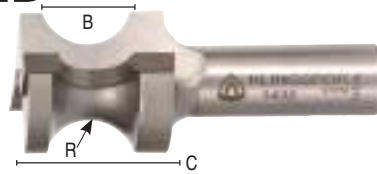

*with 1/2" shank only

HALF ROUND (BULL NOSE)

Half Round bits are used to create complete rounded edge. Also known as a "Bull Nose Bit", they are typically used in a router table or with an edge guide and are available in about any radius (based on thickness of the edge trying to round over). Carbide tipped. Two-wing cutter.

Part Number	"R" Radius	"B" Opening Of Cutter	"C" Cutting Length	Large Diameter	Price
1/4" SHANK					
1426	1/8"	1/4"	9/16"	7/8"	\$71.34
1427	3/16"	3/8"	7/8"	1"	\$85.61
1428	1/4"	1/2"	1"	1-1/8"	\$109.38
1/2" SHANK					
1429	3/32"	3/16"	1/2"	3/4"	\$71.34
1430	1/8"	1/4"	9/16"	7/8"	\$71.34
1431	3/16"	3/8"	7/8"	1"	\$71.34
1432	1/4"	1/2"	1"	1-1/8"	\$107.01
1432A	5/16"	5/8"	1"	1-1/4"	\$133.16
1433	3/8"	3/4"	1-1/4"	1-5/8"	\$161.69
1433A	7/16"	7/8"	1-1/2"	1-7/8"	\$178.35
1434	1/2"	1"	1-1/2"	1-15/16"	\$178.35
1434A	9/16"	1-1/8"	1-1/2"	1-15/16"	\$214.00
1435	5/8"	1-1/4"	1-3/4"	2-3/16"	\$214.00
1436	3/4"	1-1/2"	1-7/8"	2-7/16"	\$363.77

Note- Large Diameter minus "B" opening equals small diameter.

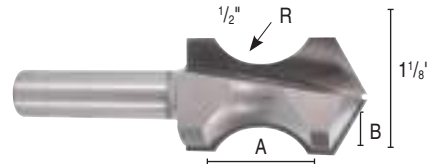

PLUNGE CUT HAND GRIP

Plunge Cut Hand Grip bit is used for plunging into the material and following a template (bearing and lock collar sold separately) to create a soft edge hand grip in drawers and doors. Carbide tipped. Two-wing cutter.

Part Number	"A" Bead Opening	"B" Bead Depth	Cutting Length	Overall Length	Price
1/2" SHANK					
1440	7/8"	1/4"	1-3/8"	3-1/2"	\$123.64

Use with B11 Bearing and LC-1/2 lock collar on shank for guide template routing.

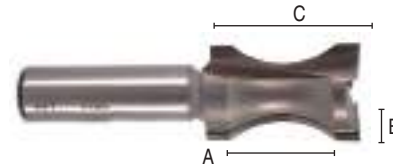

OVAL EDGE (HALF BULL NOSE)

Oval Edge is similar to the half round bit, but it doesn't create a full radius. Instead, it creates an oval edge. It can be set up to produce an oval cut top to bottom or a small shoulder at the top and bottom of the work. Carbide tipped. Two-wing cutter.

Part Number	"A" Bead Opening	"B" Bead Depth	"C" Cutting Length	Overall Length	Price
1/2" SHANK					
1470	7/8"	5/32"	1-1/4"	13/16"	\$95.11
1474	1/2"	1/8"	1"	3/4"	\$77.28
1476	3/4"	3/16"	1-1/4"	1"	\$101.07
1478	1"	3/16"	1-1/4"	1"	\$118.89
1480	1-1/2"	1/4"	1-3/4"	1-1/4"	\$147.44



V GROOVE • PANEL • COVE



Point Length

V GROOVE

V Groove bits are available in a variety of angles. They cut deep or shallow "V" grooves. These bits are great for sign making or for adding decorative accents to furniture and plaques. Carbide tipped. Two-wing cutter.

Part Number	Cutting Diameter	Point Length	Angle	Overall Length	Price
1/4" SHANK					
SC 1500	1/4"	1/8"	90°	1-1/2"	\$36.15
1501	3/8"	3/16"	90°	1-7/8"	\$42.66
1502	1/2"	1/4"	90°	1-7/8"	\$43.86
SC 1540	1/4"	7/32"	60°	1-1/2"	\$36.15
* SC 1541	1/4"	7/32"	60°	2"	\$43.27
1550	1/2"	7/16"	60°	2"	\$52.30
1/2" SHANK					
1503	1/2"	1/4"	90°	2"	\$52.30
1504	3/4"	3/8"	90°	2-1/4"	\$98.44
1506	1"	1/2"	90°	2-1/4"	\$109.38
1508	1-1/2"	3/4"	90°	2-5/8"	\$154.56
1560	1/2"	7/16"	60°	2-1/4"	\$54.70
1/2" SHANK					
15-238	1-1/4"	1/2"	110°	2-3/16"	\$222.55
15-240	1-1/4"	1/4"	130°	2-3/16"	\$222.55
15-241	1-1/4"	3/16"	150°	2-3/16"	\$246.59
1508-91Q	1-1/2"	3/4"	91°	2-1/2"	\$200.03

SC - Solid Carbide Not for miter folding.
* #1541 features three flutes for improved veining



Cut Length

POINT CUTTING ROUNDROVER

Decorative Trimming & Lettering Point Cutting Roundover bits are used to make moldings, fluting, and are popular with sign makers for routing letters. It is similar to a "V" bit but creates a rounded profile on each side instead of a flat "V". Carbide tipped. Two-wing cutter.

Part Number	Radius	Cutting Diameter	Cutting Length	Overall Length	Price
1/4" SHANK					
1570	3/16"	3/8"	3/8"	2"	\$49.93
1572	1/4"	1/2"	1/2"	2"	\$53.49
1574	3/8"	3/4"	5/8"	2"	\$67.76
1/2" SHANK					
1580	3/8"	3/4"	5/8"	2-1/4"	\$67.76

Point Cutting Roundovers are not guaranteed against breakage.



PANEL BITS - PILOT PLUNGE POINT

Panel Pilot Plunge bit has a drill through point that allows self-starting, and the pilot acts as a guide for template work. This is used heavily in the RV & mobile home industry. Carbide tipped. Two-wing cutter.

Part Number	Cutting Diameter	Cutting Length	Shank Diameter	Overall Length	Price
SINGLE FLUTE					
1700	1/4"	3/4"	1/4"	2-5/8"	\$28.43
1701	3/8"	1"	3/8"	3-3/8"	\$38.04
1702	1/2"	1-1/4"	1/2"	4"	\$38.04
1702A	1/2"	1-1/4"	1/2"	3-5/8"	\$35.67
DOUBLE FLUTE					
1704	3/8"	1"	1/4"	3-1/4"	\$55.16
1705	3/8"	1"	3/8"	3"	\$55.16
1706	1/2"	1-1/4"	1/2"	4"	\$61.82



COVE BITS

Cove bits are used to create a convex radius corner. With the bearing riding along the edge the depth can be adjusted to create a custom look. Carbide tipped. Two-wing cutter.

Part Number	Radius	Large Diameter	Cutting Length	Bearing Number	Price
1/4" SHANK					
1800A	3/16"	7/8"	1/2"	B3	\$61.82
1800	1/4"	1"	1/2"	B3	\$61.82
1801-	3/8"	1-1/4"	1/2"	B3	\$67.76
1802-	1/2"	1-1/2"	5/8"	B3	\$76.08
1/2" SHANK					
1803	1/4"	1"	1/2"	B3	\$61.82
1804	3/8"	1-1/4"	1/2"	B3	\$67.76
1805	1/2"	1-1/2"	5/8"	B3	\$76.08
1806	5/8"	1-3/4"	3/4"	B3	\$121.27
1807	3/4"	2"	7/8"	B3	\$137.91
1810	1"	2-1/2"	1"	B3	\$214.01

Bearing Number: B3

RABBETING



RABBET BITS

Rabbet bits are used to route out the edge of a workpiece. It is used primarily for installing backs of cabinets. It is available individually as well as in a set, both standard and deep. With the set, you simply change the bearing to create the different depth of cuts needed from flush to 1/2". Carbide tipped. Two-wing cutter.

Part Number	Large Diameter	Cutting Length	Cutting Depth	Bearing Number	Price
1/4" SHANK					
1880	7/8"	1/2"	1/4"	B2	\$52.87
1900	1-1/4"	1/2"	3/8"	B3	\$58.26
1951	1-3/8"	1/2"	1/2"	B2	\$64.20
1/2" SHANK					
1885	7/8"	5/8"	1/4"	B2	\$52.86
1901	1-1/4"	1/2"	3/8"	B3	\$58.26
1954	1-3/8"	1/2"	1/2"	B2	\$63.01
1959	1-7/8"	1"	3/4"	B2	\$123.64

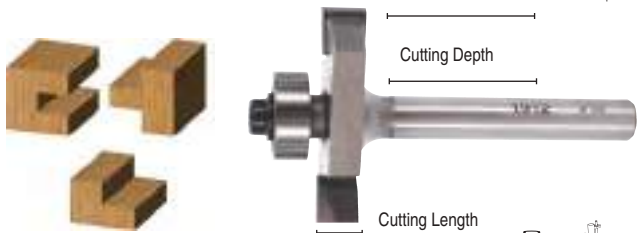

MULTI RABBET SET



Change your Rabbet depth by changing the bearing! Set includes all eight bearings to make each of the cuts shown. Hex Wrench included.



Set Number	Large Diameter	Cutting Length	Description	Price
1952	1-3/8"	1/2"	1/4" Shank Set	\$137.91
1955	1-3/8"	1/2"	1/2" Shank Set	\$137.91

Sets are organized and protected in 4" x 4" x 3" Box.

SLOTING & RABBETING

Slotting & Rabbeting bit performs similarly to the standard rabbeting bit. It has a thinner cutter to allow for a groove in the middle on one piece and a rabbeted edge top and bottom on the mating piece. This allows for the two pieces to be glued and mated together. There are several bearing options to allow for quick change of the depth of cuts. Carbide tipped. Two-wing cutter.

Part Number	Large Diameter	Cutting Length	Cutting Depth	Overall Length	Price
1/4" SHANK					
1904	1-1/4"	1/8"	3/8"	2"	\$57.08
*1908	1-1/2"	5/32"	1/2"	1-3/4"	\$49.93
1912	1-1/4"	1/4"	3/8"	2"	\$53.49
1916	1-1/4"	3/8"	3/8"	2"	\$59.45
1920	1-1/2"	1/2"	1/2"	2"	\$65.38
1/2" SHANK					
1906	1-1/4"	1/8"	3/8"	2"	\$57.08
* 1910	1-1/2"	5/32"	1/2"	2"	\$51.18
1914	1-1/4"	1/4"	3/8"	2"	\$53.49
1918	1-1/4"	3/8"	3/8"	2-1/8"	\$59.45
1922	1-1/2"	1/2"	1/2"	2-1/4"	\$65.38
1924	1-1/4"	3/4"	3/8"	2-1/2"	\$73.72

B3 Bearing supplied.

* Proper Size for Biscuit Joining

BB501 - Bearing Kit with Wrench (see pg. 35). Increase the versatility of your Rabbeting Bits by simply changing the bearing size to vary your cutting depth. This set allows 1/4", 5/16", 3/8", & 7/16" cutting depth on all 1-1/4" bits or 3/8", 7/16", 1/2", & 9/16" cutting depth on all 1-1/2" bits.

BISCUIT JOINING KIT

This kit contains our 5/32" Rabbeting Bit with 1/2" B3 bearing for cutting slots to fit #20 Biscuits. Also includes alternate bearings B14 and B15 to cut slots for #0 and #10 Biscuits. Hex Wrench included.

Part Number	Description	Price
1940	1/4" shank kit	\$77.28
1945	1/2" shank kit	\$79.52

DEEP MULTI RABBET SET

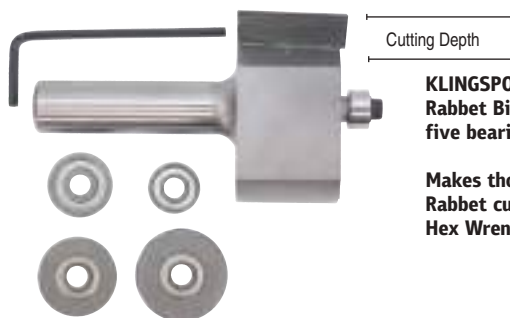

KLINGSPOR's largest Rabbet Bit in a set with five bearings.

Makes those extra deep Rabbet cuts as shown. Hex Wrench included.



Set Number	Large Diameter	Cutting Length	Description	Price
1960	1-7/8"	1"	1/2" Shank Set	\$161.69

Sets are organized and protected in 4" x 4" x 3" Box.



ROUND OVER

Roundover bits are some of the most common bits found in shops. They are used for things from easing the edge of the work to more elaborate moldings applications. They can also be used for creating a complete bullnose in two passes, or change the bearing and go from a roundover to a beading bit. They are available with or without a bearing, depending on the application and bit. Carbide tipped. Two-wing cutter.



ROUND OVER BITS Small Pilot

Extra Small Brass Pilot (5/32" dia.) allows these bits to roundover edges on finely detailed workpieces with intricate contours, tight corners, and narrow openings. These bits give professional results without all the tedious hand sanding. Carbide cutting edges far outlast comparable high speed steel bits.

Part Number	Radius	Large Diameter	Cutting Length	Overall Length	Price
1/4" SHANK					
1978	1/16"	3/8"	7/16"	2"	\$59.45
1980	1/8"	3/8"	7/16"	2"	\$57.08
1982	1/4"	5/8"	1/2"	2-1/8"	\$58.26
1984	3/8"	7/8"	5/8"	2-1/4"	\$64.20



ROUND OVER & BEADING

Ball Bearing Guide

Round-Over Part Number	Beading Part Number	Radius	Large Diameter	Cutting Length	Price
1/4" SHANK					
2000A	2100A	1/16"	5/8"	1/2"	\$54.69
2000B		3/32"	11/16"	1/2"	\$58.26
2000C	2100C	1/8"	3/4"	1/2"	\$53.50
2000D	2100D	5/32"	13/16"	1/2"	\$59.45
2000	2100	3/16"	7/8"	1/2"	\$55.88
2001	2101	1/4"	1"	1/2"	\$55.88
2002	2102	5/16"	1-1/8"	1/2"	\$61.82
2003	2103	3/8"	1-1/4"	5/8"	\$61.82
2004	2104	1/2"	1-1/2"	3/4"	\$76.08
1/2" SHANK					
2005C	2105C	1/8"	3/4"	1/2"	\$53.50
2005	2105	3/16"	7/8"	1/2"	\$58.26
2006	2106	1/4"	1"	1/2"	\$55.88
2007	2107	5/16"	1-1/8"	1/2"	\$61.82
2008	2108	3/8"	1-1/4"	5/8"	\$61.82
2008A		7/16"	1-3/8"	5/8"	\$83.22
2009	2109	1/2"	1-1/2"	3/4"	\$76.08
2009A		5/8"	1-3/4"	1"	\$123.64
2009B		9/16"	1-5/8"	3/4"	\$99.86
2010	2110	3/4"	2"	1"	\$135.54
2011		7/8"	2-1/4"	1-1/8"	\$233.03
2012		1"	2-1/2"	1-5/16"	\$260.88
2014		1-1/4"	3-1/4"	1-3/4"	\$351.92
2015		1-3/8"	3-1/2"	1-3/4"	\$385.21
2016		1-1/2"	3-3/4"	1-7/8"	\$385.21

Bearing: Use B3 for Rounding Over
Use B2 for Beading
Use B4 for 2013 thru 2016



MULTI BEADING SETS

For extra deep beading Roundover and More! Conventional Beading only cuts a shallow 1/16" bead. Expand your capabilities with these versatile sets. Deeper beads create a more pronounced edge on larger pieces. Includes all four bearings and Hex Key Wrench.

Part Number	Radius	Large Diameter	Cutting Length	Overall Length	Price
1/2" SHANK					
2040B	1/4"	1-1/4"	1/2"	2-3/8"	\$90.36
2042B	3/8"	1-1/2"	5/8"	2-1/2"	\$101.65
2044B	1/2"	1-3/4"	3/4"	2-5/8"	\$107.01

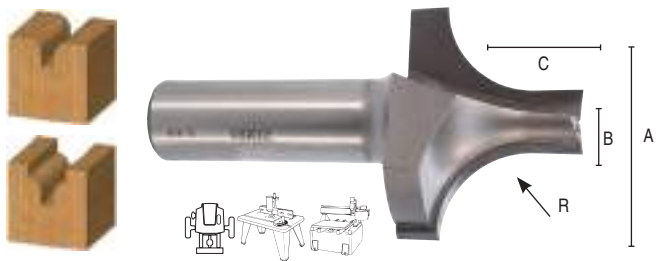

PLUNGE ROUND OVER With Plunge Point

Part Number	"R" Radius	"A" Large Diameter	"B" Small Diameter	"C" Pattern Length	Overall Length	Price
1/4" SHANK						
2050	1/8"	3/8"	1/8"	1/4"	1-3/4"	\$52.30
2051	3/16"	5/8"	1/4"	1/8"	1-3/4"	\$71.34
2052	1/4"	3/4"	1/4"	3/8"	1-7/8"	\$80.84
1/2" SHANK						
2055	1/4"	3/4"	1/4"	1/4"	2"	\$80.85
2056	1/4"	3/4"	1/4"	3/8"	2"	\$89.16
2057	3/8"	1"	1/4"	5/16"	2-1/8"	\$99.86
2058	3/8"	1"	1/4"	9/16"	2-1/4"	\$135.54
2060	1/2"	1-3/8"	3/8"	3/4"	2-1/2"	\$140.71
2062	9/16"	1-5/8"	1/2"	1"	2-3/4"	\$233.03
2064	5/8"	1-3/4"	1/2"	1-5/16"	3"	\$260.88
2066	3/4"	2"	1/2"	1-5/16"	3"	\$351.92

ROUND OVER & EDGE TRIM (Long Nose)

Part Number	"R" Radius	"A" Large Diameter	"B" Small Diameter	"C" Pattern Length	Overall Length	Price
1/2" SHANK						
* 2068	3/16"	1"	1/2"	13/16"	2-5/8"	\$385.21
* 2072	1/4"	1-1/8"	1/2"	13/16"	2-5/8"	\$154.56
* 2076	3/8"	1-3/8"	1/2"	13/16"	2-3/4"	\$171.21

* Edge Trim for 3/4" stock

ROMAN OGEE • CHAMFER



DOUBLE ROUND OVER

with Adjustable Cutting Length Double Roundover bit is as the name implies. It is an adjustable bit that creates a rounded edge on the top and bottom of the work at the same time. The bearing is changeable, to allow the bit to go from a roundover to a beading application. Carbide tipped. Two-wing cutter.

Part Number	Radius	Large Diameter	Overall Length	Price
1/2" SHANK				
2160	1/8"	1-1/8"	3-3/4"	\$133.16
2162	3/16"	1-1/4"	3-3/4"	\$133.16
2164	1/4"	1-3/8"	3-3/4"	\$133.16

Assemblies Sold with B5 Bearing for flush round over
Use B20 Bearing for 1/16" Bead • Use B27 Bearing for 1/8" Bead
Replacement Cutter Heads: Add RH to Part Number for cutter next to shank, Add LH to Part Number for end cutter.
Example: 2160LH



ROMAN OGEE

Roman Ogee bits has a convex curve at the bearing and a concave curve at the top. It is a decorative profile that jazzes up any wood edge. Carbide tipped. Two-wing cutter.

Part Number	Radius	Large Diameter	Cutting Length	Overall Length	Price
1/4" SHANK					
2200	5/32"	1-1/8"	9/16"	2"	\$82.03
2201	1/4"	1-1/2"	11/16"	2-1/4"	\$89.16
1/2" SHANK					
2202	5/32"	1-1/8"	9/16"	2-1/4"	\$82.03
2203	1/4"	1-1/2"	11/16"	2-3/8"	\$89.16
2210	3/8"	2"	1"	2-3/4"	\$133.16

Bearing Number: B3



PART # 2200/2202



PART # 2201/2203



PART # 2210



45° CHAMFER

with Adjustable Cutting Length 45° Chamfer & Edge Bevel bits produce a 45° angle on the material and are used as a decorative edge or miter joint to produce uniformly crisp angles. Carbide tipped. Two-wing cutter.

Part Number	"A" Degree of Angle	"B" Cutting Length	"C" Cutting Height	Overall Length	Price
1/4" SHANK					
2292	45°	7/16"	5/16"	1-7/8"	\$57.08
2302	45°	5/8"	7/16"	2"	\$63.01
1/2" SHANK					
2305	45°	5/8"	7/16"	2-1/4"	\$63.01
2306	45°	1-1/16"	3/4"	2-1/2"	\$98.09
2310	45°	1-1/2"	1-1/16"	3"	\$185.47

Bearing Number: B3 (Use B2 on #2292)
*** 2292 has 1" large diameter for use in trim routers.**



25° BEVEL

EDGE BEVEL

Edge Bevel bits are similar to the chamfer bits, but produce 60°, 30°, 25°, 22-1/2°, 15°, or 7° angles on the material and are used as a decorative edge or miter joint to produce uniformly crisp angles. Carbide tipped. Two-wing cutter.

Part Number	"A" Degree of Angle	"B" Cutting Length	"C" Cutting Height	Overall Length	Price
1/4" SHANK					
*2298	7°	3/8"	1/2"	2-1/8"	\$46.37
2300	15°	1/2"	1/2"	2"	\$48.51
*2300A	15°	1/4"	1/4"	2"	\$43.99
2301	25°	9/16"	1/2"	2"	\$50.41
1 2308	30°	7/8"	3/4"	2-3/4"	\$80.85
1/2" SHANK					
3 2325	15°	1"	15/16"	2-3/4"	\$66.57
2 2307	22 1/2°	15/16"	7/8"	2-3/4"	\$71.19
1 2309	30°	7/8"	3/4"	2-3/4"	\$73.72
2318	60°	9/16"	1/2"	2-1/2"	\$171.73

Bearing Number: B3
*** Used on Laminate Trim**
 1 Used for six sided boxes
 2 Used for eight sided boxes
 3 Used for twelve sided boxes



15° BEVEL



22 1/2° BEVEL



30° BEVEL



FLUSH TRIM

- **Flush Trim bits** are designed to be used to trim flush laminate work or template work. The bearing follows the template and the cutter trims the workpiece. These bits have the bearing on the bottom end (away from the shank) of the bit. Carbide tipped unless specified otherwise.
- **Two flute flush trim bits** provide a good general purpose option that will give both quick cuts and nice finishes.
- **Three flute bits** offer an extremely smooth finish with three cutters doing the work.
- **Flush Trim downshear bits** will leave the top of the work surface a little cleaner due to the slight angle cutting action (shear).
- **Flush Trim downshear two flute** version offers two flutes for an even better finish cut with a down shear action.
- **Flush Trim V-Groove bits** are ideal for flushing the workpiece to a template and simultaneously cutting a subtle "V" shape groove where two pieces butt together. This aids in hiding the seam and adds a decorative accent.
- **Overhang Trim Bits** are similar to a conventional flush trim bit, but the bearing is oversized providing a 1/16" or 1/8" overhang between the edge of the cutting surface and template. Carbide tipped. Double flute.
- **Combination Flush Trim bits** allow the template to be placed on top of or below the workpiece. This is a combination straight router bit with properly sized ball bearing guides on both the end of the cutter and the shank. This is ideal for heavy duty flush trimming operations such as laminating tables and counter tops. It also works well for table based pattern routing as well. Carbide tipped. Double flute.



OVERHANG TRIM BIT

Part Number	Overhang	Cutting Diameter	Cutting Length	Bearing Number	Price
1/4" SHANK					
2468	1/16"	3/8"	1/2"	B3	\$46.37
2470	1/8"	3/8"	1/2"	B7	\$46.37



FLUSH TRIM - THREE FLUTE

Part Number	Cutting Diameter	Cutting Length	Overall Length	Bearing Number	Price
1/4" SHANK					
2500	1/2"	1"	2-5/8"	B3	\$54.70
2501	1/2"	1/2"	2-1/8"	B3	\$51.12
1/2" SHANK					
2502	1/2"	1"	3-1/4"	B3	\$55.88
2504	1/2"	1-1/2"	3-5/8"	B3	\$67.34
2505	1/2"	2"	4"	B3	\$85.60
1/2" SHANK - DOUBLE BEARING					
2554	1/2"	1-1/2"	3-7/8"	Two B3	\$118.18
2555	1/2"	2"	4-1/4"	Two B3	\$135.54



FLUSH TRIM-TWO FLUTE

Part Number	Cutting Diameter	Cutting Length	Overall Length	Bearing Number	Price
1/4" SHANK					
2400	3/8"	1"	2-5/8"	B1	\$40.18
2401	3/8"	1/2"	2-1/8"	B1	\$38.24
2402	1/2"	1"	2-5/8"	B3	\$40.18
2403	1/2"	1/2"	2-1/8"	B3	\$38.24
1/2" SHANK					
2404A	3/8"	1"	3-1/8"	B1	\$42.81
2405	1/2"	1"	3-1/4"	B3	\$41.84
2406	1/2"	1/2"	2-3/4"	B3	\$41.15
2407	1/2"	1-1/2"	3-5/8"	B3	\$50.41
2408	1/2"	2"	4"	B3	\$63.73
2410	3/4"	1-1/4"	3-1/4"	B4	\$58.97
2415	7/8"	1-1/2"	3-1/2"	B21	\$63.01
1/2" SHANK - DOUBLE BEARING					
2457	1/2"	1-1/2"	3-7/8"	Two B3	\$101.06
2458	1/2"	2"	4-1/4"	Two B3	\$114.13



DOWNSHEAR FLUSH TRIM

Two Flute					
Part Number	Cutting Diameter	Cutting Length	Overall Length	Bearing Number	Price
1/4" SHANK					
2602	1/2"	1"	2-5/8"	B3	\$49.93
2560	3/4"	5/8"	2-1/8"	B4	\$61.82
1/2" SHANK					
2605	1/2"	1"	3-1/4"	B3	\$51.12
2570	3/4"	1"	3"	B4	\$71.34
2580	3/4"	2"	4"	B4	\$94.17



COMBINATION FLUSH TRIM

with Top and Bottom Bearings

Part Number	Cutting Diameter	Cutting Length	Overall Length	Bearing Number	Price
1/4" SHANK					
2702	1/2"	1"	2-5/8"	B3 & B9	\$59.45
1/2" SHANK					
2715	7/8"	1-1/2"	3-1/2"	B13 & B21	\$80.85

FLUSH TRIM V-GROOVE

Part Number	Cutting Diameter	Cutting Length	Shank Diameter	Overall Length	Bearing Number	Price
2425	1/2"	1"	1/4"	2-5/8"	B3	\$52.79
2426	1/2"	1"	1/2"	3-1/4"	B3	\$52.79

LAMINATE TRIM

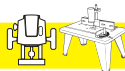

LAMINATE TRIM BITS

Two Flute - Ball Bearing Laminate Trim bits are flush trim bits, but designed for thinner stock like laminates and veneers. They offer a flush, 7°, 15°, and 25° angle. The bevel bits are ideal for trimming the laminate flush while also easing the top edge for faster filing. Carbide tipped. Double flute.

Part Number	Bevel Degree	Large Diameter	Cut Length	Bearing Number	Price
1/4" SHANK					
2401	Flush	3/8"	1/2"	B1	\$38.24
2298	7°	9/16"	7/16"	B3	\$46.37
2300A	15°	5/8"	1/4"	B3	\$43.99
2301	25°	1"	9/16"	B3	\$50.41

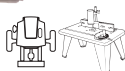

STANDARD FLUSH TRIM SOLID CARBIDE

Standard Flush Trim bits are an economical solid carbide flush trim that does not use a bearing, but instead has a smooth portion milled into the solid carbide, which rides along the edge being trimmed to. They offer extended life and minimal vibration.

Part Number	Cutting Length	Shank Diameter	Overall Length	Price
SC28B	1/4"	1/4"	1-1/2"	\$22.59



7° BEVEL TRIM SOLID CARBIDE

7° Bevel Trim bits are identical to the standard flush bits, but offer a 7° bevel, which slightly eases the top edge of laminate to reduce filing.

Part Number	Cutting Length	Shank Diameter	Overall Length	Price
SC29	1/4"	1/4"	1-1/2"	\$24.97



This is the ideal router bit for all plastic laminate work. The "Trim-N-File" router bit does multiple operations at once. 1) It will trim the laminate overhang flush to the edge with a slight bevel, while 2) simultaneously creating a slight radius along the top edge. 3) All this is accomplished by following the heavy duty ball bearing, which slightly protrudes past the cutter to make it all work. By simply adjusting the depth of cut on the router to best match the laminate thickness, a perfectly flush edge is achieved and the top edge is smooth. This means that the operator won't have to come back and file the edge flush and top rounded like with traditional flush trim bits, so he is saving both time and money.

Part Number	Radius	Bevel Degree	Large Diameter	Cut Length	Bearing	Price
1/4" SHANK						
2630	1/16"	2°	1-1/16"	5/16"	B3	\$52.55
* 2631	1/16"	2°	1-1/16"	5/16"	B3SQ	\$60.02

* Square bearing

LAMINATE TRIMMERS

Here's a Square Deal! A quality KLINGSPOR Trim Bit with the exclusive Euro Square Bearing. How does it work? The square bearing stops spinning as soon as it touches the workpiece. Then the side of the square simply slides along the workpiece edge. Compare this to a regular bearing that rolls along the edge - building up more glue and residue with every revolution. Plus, the square is made from non-stick Teflon®, so it wipes clean easily and it won't mark your workpiece. If you cut laminates, you need to try this bit.

Square Bearing Laminate Trimmer bits offer a unique solution to the problem of glue build up during the laminate flush trimming process. Between the square bearing and the cutter is a wider than normal trough (gap), which allows the excess glue to be evacuated much easier than a traditional flush trim. Carbide tipped. Double flute.



PART # 2640



PART # B35Q



PART # 2660



PART # B8SQ

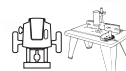

Part Number	Cutting Diameter	Cutting Length	Overall Length	Bearing Number	Price
1/4" SHANK					
2640	1/2"	1/4"	1-5/8"	B3SQ	\$53.49
2650	3/4"	5/8"	2-1/4"	B8SQ	\$71.09
1/2" SHANK					
2660	3/4"	5/8"	2-1/4"	B8SQ	\$71.09

These bits are designed with a slight taper on the cutting diameter. This allows up or down adjustment to achieve an exact blend - even after resharping.



SOLID SURFACE BITS



ROUND OVER

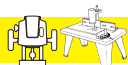

With Non-Marring Bearing Round Over with non-marring bearing is ideal for creating a perfect radius on the top of a solid surface edge. It is supplied with a special non-marring nylon sleeve bearing to eliminate burn marks along the edge. Carbide tipped. Two-wing cutter.

Part Number	Material Thickness	Radius	Overall Length	Bearing Number	Price
1/2" SHANK					
2006N	1/2"	1/4"	2-1/4"	B3S	\$64.20
2009N	1"	1/2"	2-1/2"	B3S	\$84.41
2010N	1-1/2"	3/4"	2-3/4"	B3S	\$143.85

Supplied With Non-Marring Nylon Sleeved Bearing (Part #B3S).

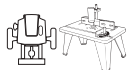

ROUNDING UNDER

Rounding Under bits with non-marring bearing is ideal for creating a perfect radius on the bottom of a solid surface edge. It is supplied with a special non-marring nylon sleeve bearing to eliminate burn marks along the edge. Carbide tipped. Two-wing cutter.

Part Number	Material Thickness	Radius	Overall Length	Bearing Number	Price
1/2" SHANK					
2030	1/2"	1/4"	2-3/4"	B5	\$104.63
2034	1"	1/2"	3"	B5	\$194.99
2036	1-1/2"	3/4"	3-3/8"	B5	\$274.04



BEVEL UNDERMOUNT BOWL



Bevel Undermount Bowl bits with non-marring bearing is ideal for creating a perfect bevel angle for undermount sinks that require a bevel on the edge of a solid surface edge mating to the sink. It is supplied with a special non-marring nylon sleeve bearing to eliminate burn marks along the edge and sink. Carbide tipped. Two-wing cutter.

Part Number	Material Thickness	Radius	Overall Length	Bearing Number	Price
1/2" SHANK					
2944	1/2-3/4"	12°	3"	BB300	\$154.56
2944-13	1/2-3/4"	13°	3"	BB300	\$284.08

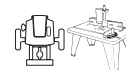

ROUNDING OVER UNDERMOUNT

Rounding Over Undermount bits with non-marring bearing is ideal for creating a perfect radius and precise angle (depending on undermount sink manufacturer specifications) on the top of a solid surface edge. It is supplied with a special non-marring nylon sleeve bearing to eliminate burn marks along the edge and sink. Carbide tipped. Two-wing cutter.

Part Number	Material Thickness	Radius	Overall Length	Bearing Number	Price
1/2" SHANK					
2929	1/2"	18°	3"	BB300	\$223.51
2910	1/2"	10°	3"	BB300	\$208.05
2915	1/2"	15°	3"	BB315	\$208.05
2918	1/2"	18°	3"	BB318	\$208.05

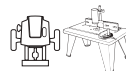

OVERHANG BOWL TRIM

Overhang Bowl Trim bits with non-marring bearing is ideal for creating a perfect bevel angle for undermount sinks that require a bevel on the edge of a solid surface edge mating to the sink. It is supplied with a special non-marring nylon sleeve bearing to eliminate burn marks along the edge and sink. Carbide tipped. Two-wing cutter.

Part Number	Material Thickness	Radius	Overall Length	Bearing Number	Price
1/2" SHANK					
2945	1/2-3/4"	3/4"	2-7/8"	BB300	\$128.39

“Solid Surface was first introduced in 1967 under the name Corian. Since the expiration of the original patent, several other manufacturers have entered the market with their own branded products. It is composed of a combination of alumina trihydrate (ATH), acrylic, epoxy or polyester resins, and pigments.”

TEMPLATE • T-SLOT



TEMPLATE BITS

Ball Bearing Guide Template Bits with ball bearing guide are similar to a flush trim in that they will trim the workpiece flush, but the bearing is on the top (near the shank) of the cutter instead of the bottom. KLINGSPOR template bits use replaceable bearings and lock collars. Carbide tipped. Two-wing cutter.

Part Number	Cutting Diameter	Cutting Length	Overall Length	Bearing Number	Price
1/4" SHANK					
* 3000A	1/2"	1/8"	1-3/4"	B9	\$53.50
* 3000	1/2"	1/4"	1-7/8"	B9	\$51.12
3001	1/2"	1/2"	2"	B9	\$53.49
3002	1/2"	3/4"	2-1/4"	B9	\$55.88
3004	1/2"	1"	2-1/2"	B9	\$57.54
* 3006	5/8"	1/4"	1-3/4"	B6	\$55.88
K41	5/8"	1/2"	2-1/4"	B6	\$71.34
K43	5/8"	3/4"	2-1/2"	B6	\$76.09
3008	5/8"	1"	2-1/2"	B6	\$70.16
* 3010	3/4"	1/4"	1-3/4"	B4	\$55.88
3012	3/4"	3/4"	2-3/8"	B4	\$69.46
3014	3/4"	1"	2-5/8"	B4	\$71.22
3/8" SHANK					
3015	7/8"	1"	2-5/8"	B12	\$90.36
1/2" SHANK					
3016	1-1/8"	1"	3"	B11	\$90.36
3018	1-1/8"	1-1/2"	3-1/2"	B11	\$101.06
3019	1-1/8"	2"	4"	B11	\$130.78
*** 3020	3/4"	1"	2-3/4"	*** B19	\$76.08
*** 3021	3/4"	1-1/4"	3"	*** B19	\$80.85
*** 3022	3/4"	1-1/2"	3-1/4"	*** B19	\$89.16
3022A	7/8"	1-1/2"	3-1/2"	B13	\$89.17
*** 3023	3/4"	2"	3-5/8"	*** B19	\$109.38

* Dado Clean out bits. Use to Square the bottom of dado cuts made on a table saw.
*** KLINGSPOR recommends using bits over 3/4" diameter in 1/2" shank whenever possible due to the fragile nature of the B19 bearing.



TEMPLATE BITS

With Oversize Bearings Template bits with over size bearings are similar to a template bit in that they have a bearing on the top of the cutter but instead of trimming flush, they offset the cut. These are made to replace bits and work with specific router jigs. KLINGSPOR template bits use replaceable bearings and lock collars. Carbide tipped. Two-wing cutter.

Part Number	Cutting Diameter	Cutting Length	Overall Length	Bearing Diameter	Bearing Number	Price
1/4" SHANK						
1 3025	5/16"	3/4"	2-3/4"	1/2"	B9	\$159.98
2 3027	1/2"	1/4"	1-7/8"	5/8"	B6	\$55.88
3 3028	1/2"	1/4"	1-7/8"	3/4"	B4	\$55.88
1,4 3032	9/16"	3/4"	2-1/4"	5/8"	B6	\$59.45

- 1 For Porter-Cable Morten[®], Mortise & Tenon Jig, and Omnijig[®] templates
2 Porter-Cable Hinge Butt Mortise Bit
3 For Hinge-Mate-II Template
4 Keller Box Joint Bit



KEYHOLE BITS

Keyhole bits are used to create a small keyhole slot on the back of picture frames, plaques, signs, etc. Simply plunge the bit and make a groove in the proper direction to allow for a screw or nail to hold the workpiece on the wall. Carbide tipped.

Part Number	Large Diameter	Small Diameter	Cutting Length	Overall Length	Price
1/4" SHANK					
3050	3/8"	3/16"	7/16"	1-1/2"	\$33.29
3052	1/2"	5/16"	7/16"	1-1/2"	\$42.81
1/2" SHANK					
3051	3/8"	3/16"	7/16"	2-1/8"	\$38.04
3053	1/2"	5/16"	7/16"	2-1/8"	\$44.71

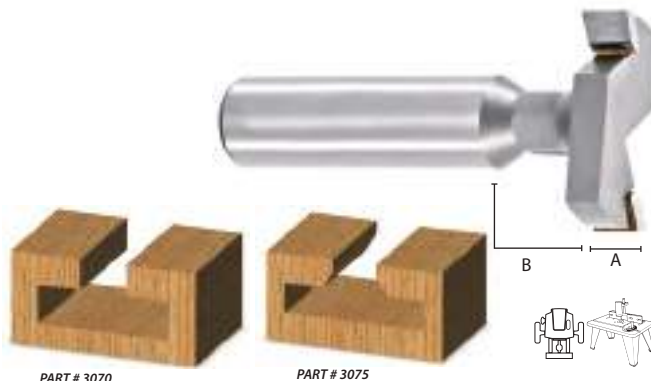

T-SLOT CUTTER

T-Slot Cutter "Slatwall" bits create a T-slot in wood for making jigs and fixtures in the shop. This allows a bolt to slide the length of the slot for easy adjustment of the jig. Carbide tipped.

Part Number	Large Diameter	Small Diameter	"A" Length	"B" Length	Overall Length	Price
1/2" SHANK						
3070	1-1/16"	3/8"	5/16"	1/2"	2-3/8"	\$130.78
3075	1-3/16"	3/8"	1/4"	3/8"	2-3/8"	\$145.99



SLOT & UNDERCUT BITS

Used to cut all types of slots and grooves. Also used to undercut decorative patterns or large letters to give them a bold appearance. This can even be used by hardwood flooring contractors to replace boards in existing floors. They have a replaceable bearing and collar. Carbide tipped.

Part Number	Large Diameter	"A" Length	"B" Depth	Overall Length	Price
1/4" SHANK					
3094	3/4"	1/8"	1/4"	1-7/8"	\$44.94
* 3094B	3/4"	1/8"	1/8"	1-7/8"	\$62.77
3098	1"	1/4"	3/8"	2"	\$50.88
* 3098B	1"	1/4"	1/4"	2"	\$67.76
3110	1-1/2"	1/4"	5/8"	2"	\$58.26
* 3110B	1-1/2"	1/4"	1/2"	2"	\$75.49

* B denotes Bearing (B9) guide on shank.



EDGE PROFILES



COVE & BEAD

Cove & Bead bits as the name implies, creates a decorative cove at the top, small step, then a bead (convex shape) at the bottom. Carbide tipped two-wing cutter

Part Number	Radius	Large Diameter	Cutting Length	Overall Length	Price
1/4" SHANK					
3209	5/32"	1-1/8"	1/2"	2"	\$92.74
3210	1/4"	1-5/16"	5/8"	2-1/8"	\$92.74
1/2" SHANK					
3211	5/32"	1-1/8"	1/2"	2-1/4"	\$92.74
3212	1/4"	1-5/16"	5/8"	2-3/8"	\$92.74

Bearing Number: B3



OGEE FILLET

Ogee Fillet bits create an attractive small step (fillet) at the top then an ogee (convex then concave) at the bottom. Carbide tipped two-wing cutter.

Part Number	Radius	Large Diameter	Cutting Length	Overall Length	Price
1/4" SHANK					
3214	3/16"	1-3/8"	5/8"	2-1/8"	\$89.88
1/2" SHANK					
3216	3/16"	1-3/8"	5/8"	2-1/2"	\$89.88
3218	1/4"	1-5/8"	3/4"	2-5/8"	\$104.86

Bearing Number: B3



*with 1/2" shank only

OGEE

Ogee bits produce a simple cove at the top and a convex (bead) at the bottom of the workpiece. Carbide tipped two-wing cutter.

Part Number	Radius	Large Diameter	Cutting Length	Overall Length	Price
1/4" SHANK					
3220	5/32"	1-1/8"	1/2"	2"	\$90.21
3224	1/4"	1-1/2"	5/8"	2-1/8"	\$97.49
1/2" SHANK					
3222	5/32"	1-1/8"	1/2"	2-1/4"	\$90.21
3226	1/4"	1-1/2"	5/8"	2-3/8"	\$97.49
3228	9/64"&5/16"	1-5/8"	5/8"	2-1/2"	\$104.87

Bearing Number: B3



CLASSICAL PATTERN

Classical Pattern bits form a step down from the top, which transitions into a bead and step out. Then the cutter produces a cove at the bottom of the cut. This is a popular bit used to mill moldings. Carbide tipped two-wing cutter.

Part Number	Radius	Large Diameter	Cutting Length	Overall Length	Price
1/4" SHANK					
3230	5/32"	1-1/4"	1/2"	2-1/8"	\$94.17
3234	3/16"	1-1/2"	5/8"	2-1/4"	\$103.91
1/2" SHANK					
3232	5/32"	1-1/4"	1/2"	2-3/8"	\$94.17
3236	3/16"	1-1/2"	5/8"	2-1/2"	\$103.91

Bearing Number: B3

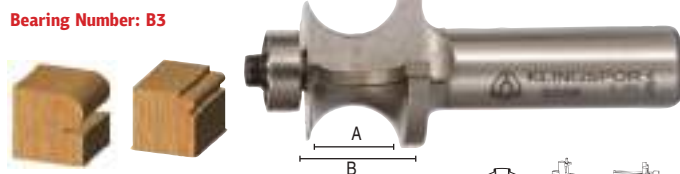

EDGE BEADING

Edge Beading bits offers three types of cuts using the same bit, depending upon the set up. You can create an edge, or corner bead with or without a fillet (step) at the top, or a full corner bead by making one pass with the bearing along the edge and another pass with the bearing along the top. Carbide tipped Two-wing cutter.

Part Number	Large Diameter	Bead Diameter	Cutting Length	Overall Length	Price
1/4" SHANK					
3240	7/8"	1/8"	9/16"	2"	\$70.86
3244	7/8"	1/4"	9/16"	2"	\$80.85
3248	1"	5/16"	5/8"	2-1/4"	\$77.26
3252	1-1/16"	3/8"	3/4"	2-1/4"	\$92.74
3256	1-1/16"	1/2"	3/4"	2-1/4"	\$97.49
1/2" SHANK					
3242	7/8"	1/8"	9/16"	2-1/4"	\$70.86
3246	7/8"	1/4"	9/16"	2-1/4"	\$80.85
3250	1"	5/16"	5/8"	2-1/4"	\$87.98
3254	1-1/16"	3/8"	3/4"	2-1/2"	\$92.74
3258	1-1/16"	1/2"	3/4"	2-1/2"	\$97.49
3260	1-3/8"	5/8"	1"	2-5/8"	\$121.27
3262	1-1/2"	3/4"	1-1/8"	3"	\$133.16

Bearing Number: B3



FRENCH TRADITIONAL

French Traditional bits produces a simple accent profile that starts with a small concave radius at the top then is steps down to a larger bead at the bottom. It is a classic French Traditional profile for table tops, drawer fronts, panel edges, moldings, and trim. Carbide tipped Two-wing cutter.

Part Number	"R1" Radius	"R2" Radius	Large Diameter	Cutting Length	Overall Length	Price
1/2" SHANK						
3272	3/16"	5/16"	1-1/2"	5/8"	2-1/2"	\$116.17

Bearing Number: B3

EDGE PROFILES

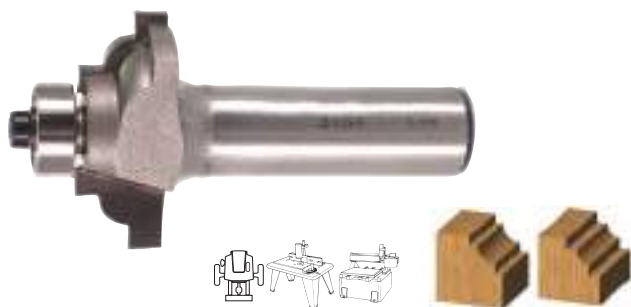

CLASSICAL COVE

Classical Cove bits create a decorative step & cove design along the edge of a workpiece. Carbide tipped. Two-wing cutter.

Part Number	Radius	Large Diameter	Cutting Length	Overall Length	Price
1/2" SHANK					
3164	5/32"	1-1/4"	1/2"	2-1/4"	\$84.41
3166	1/4"	1-3/8"	3/4"	2-1/2"	\$95.11

Bearing Number: B3



WAVY EDGE

Wavy Edge bits create a decorative step, wavy convex & concave edge design on the workpiece. Carbide tipped. Two-wing cutter.

Part Number	Radius	Large Diameter	Cutting Length	Overall Length	Price
1/2" SHANK					
3172	1/8"	1-1/4"	3/4"	2-1/2"	\$85.60

Bearing Number: B3



FULL BEAD

Full Bead bits offer an ideal way to accent different projects, from adding beads to furniture legs, railings, moldings or even post beams. KLINGSPOR's full bead router bits also offer two separate bearings which make it very easy to use on template work. Carbide tipped. Two-wing cutter.

Part Number	Radius	Large Diameter	Cutting Length	Overall Length	Price
1/4" SHANK					
3190	1/8"	7/8"	5/16"	2-1/8"	\$90.36
3192	3/16"	1"	1/2"	2-3/8"	\$95.11
3194	1/4"	1-1/8"	5/8"	2-1/2"	\$114.13

Bearing Number: One B6 & One B7



MULTI-BEADING

Multi-Beading bits are great for making multiple beads in one pass in moldings, furniture parts, columns, etc. Carbide tipped. Two-wing cutter.

Part Number	Radius	Large Diameter	Cutting Length	Overall Length	Price
1/4" SHANK					
3200	1/8"	7/8"	1"	2-1/2"	\$111.14
1/2" SHANK					
3202	1/8"	7/8"	1"	2-3/4"	\$111.14

Bearing Number: B3

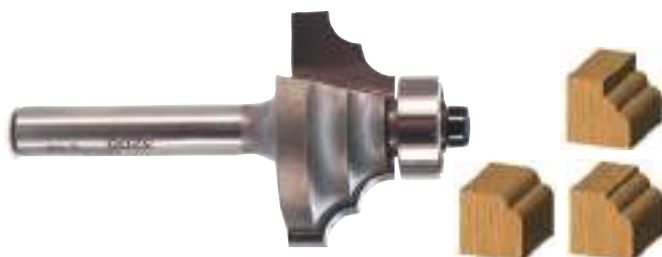

DOUBLE ROUND

Double Round bits create a decorative double round over along the edge of the workpiece. This produces a nice door edge, molding, furniture profile and more. Carbide tipped two-wing cutter.

Part Number	Radius	Large Diameter	Cutting Length	Overall Length	Price
1/4" SHANK					
3205	5/32"	1-1/8"	1/2"	2"	\$92.26
1/2" SHANK					
3207	5/32"	1-1/8"	1/2"	2-1/4"	\$92.26
3208	7/32"	1-3/8"	5/8"	2-1/2"	\$99.86

Bearing Number: B3

“Sanding the edge profiles created by these bits can be tricky and time-consuming. Klingspor has several options to make this process quicker and easier. Ask your Factory Sales Rep about our contour sanding options.”



EDGE PROFILES

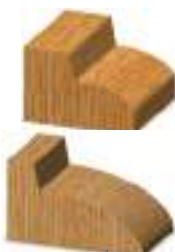

THUMBNAIL TABLE EDGE



Thumbnail Table Edge bits are used as a decorative edge for tables or large panels or as part of a handrail profile (3294). Carbide tipped two-wing cutter.

Part Number	Profile Width	Large Diameter	Cutting Length	Overall Length	Price
1/4" SHANK					
3290	7/16"	1-3/8"	3/8"	1-7/8"	\$90.36
1/2" SHANK					
3292	7/16"	1-3/8"	3/8"	2"	\$90.36
3294	1"	2-1/2"	3/4"	2-1/2"	\$185.47

Bearing Number: B3



TRADITIONAL TABLE EDGE



Traditional Table Edge bits are another popular choice edges on larger panels, tables and more. It produces a soft cove and bead. Carbide tipped two-wing cutter.

Part Number	Profile Width	Large Diameter	Cutting Length	Overall Length	Price
1/2" SHANK					
3228	9/16"	1-5/8"	5/8"	2-1/2"	\$114.13
3296	1"	2-1/2"	3/4"	2-1/2"	\$162.77

Bearing Number: B3

HANDRAIL BITS

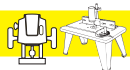

Used to cut the lower portion of the handrail profile. Handrail bits are designed to be used with other bits (see image below) to create wooden handrails. Two basic profiles are offered with similar cuts. One is large and the other is small. Carbide tipped, two-wing cutter.



Part Number	Profile Width	Large Diameter	Cutting Length	Overall Length	Price
1/2" SHANK					
3305	1-1/4"	2"	1/4"	3-7/8"	\$216.38

Bearing Number: B3



CLASSICAL OGEE TABLE EDGE



Classical Ogee Table Edge bit is used as a profile option for tables or large a workpiece or in conjunction with a handrail bit to create custom handrail tops. Carbide tipped two-wing cutter.

Part Number	Profile Width	Large Diameter	Cutting Length	Overall Length	Price
1/2" SHANK					
3298	1"	2-1/2"	3/4"	2-1/2"	\$185.47

Bearing Number: B3



FRENCH BAROQUE TABLE EDGE

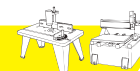

French Baroque Table Edge bit is a large symmetrical profile that produces a cove at the top and bottom and a bead in the middle. It can be used alone or with other bits to create stunning and eye-catching moldings and project edges. Carbide tipped, two-wing cutter.

Part Number	Profile Width	Large Diameter	Cutting Length	Overall Length	Price
1/2" SHANK					
3300	7/8"	2-1/4"	3/4"	2-1/2"	\$185.47

Bearing Number: B3



THUMBNAIL & BEAD TABLE EDGE

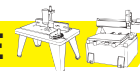

Thumbnail & Bead Table Edge bit is a thumbnail profile with a small, simple bead at the top, which adds a nice accent to any large panel or table top. Carbide tipped, two-flute cutter.

Part Number	Profile Width	Large Diameter	Cutting Length	Overall Length	Price
1/2" SHANK					
3302	1"	2-1/2"	3/4"	2-1/2"	\$185.47

Bearing Number: B3

GLUE JOINTS

Locking Drawer Glue Joint bits (3346, 3347, 3350, & 3352) are the perfect tool for making drawers from wood. One bit does it all. After the proper height is set, it is just a matter of running the drawer front with the outside face up, flat on the table. The side pieces are machined vertically, their inside faces against the fence and cutter. Carbide tipped, two-wing cutter.

LOCKING DRAWER GLUE JOINTS



DRAWER FRONT
ONE TOOL MAKES BOTH CUTS

Part Number	Large Diameter	Cutting Length	Shank Diameter	Overall Length	Price
3346	3/4"	1/2"	1/4"	1-7/8"	\$80.85
3347	1"	1/2"	1/2"	2-1/8"	\$85.60

LOCKING DRAWER GLUE JOINTS

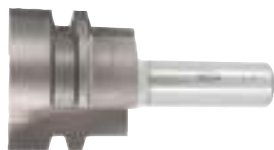

ONE TOOL MAKES BOTH CUTS



DRAWER FRONT

Part Number	Large Diameter	Cutting Length	Shank Diameter	Overall Length	Price
3352	1"	1"	1/2"	2-3/8"	\$126.31



ONE TOOL MAKES BOTH CUTS

STANDARD GLUE JOINT

Standard Glue Joint bit provides lots of glue surface to join boards together. One cutter makes both cuts, so no need to make two set-ups. Board "A" runs face down and board "B" face up. A test piece may be required to fine tune the set up. Carbide tipped two wing cutter.

Part Number	Large Diameter	Cutting Length	Shank Diameter	Overall Length	Price
3354	1/2" - 1-1/4"	1-1/2"	1/2"	2-3/4"	\$147.42

ONE TOOL MAKES BOTH CUTS



45° LOCK MITER

45° Lock Miter bits deliver double the glue surface of a traditional 45° miter. It creates both the miter and a joint lock at the same time, which prevents movement when clamping pressure is applied. Board "A" is ran horizontally, while board "B" is ran vertically. Carbide tipped, two-wing cutter.

Part Number	Large Diameter	Cutting Length	Shank Diameter	Overall Length	Price
3360	1/2" - 1-1/4"	3-1/8"	1/2"	2-7/8"	\$290.10
3362	1/2" - 3/4"	2"	1/2"	2-3/8"	\$214.01

Note: 3362 is recommended for stock thickness 1/2" - 3/4"



WEDGE TONGUE & GROOVE

Wedge Tongue & Groove bits are the ideal bits for joining two boards together where strength and alignment are important. This set is for joints that are glued along the length. The wedge shape of the tongue increases the glue surface - adding to the strength of the joint. This set should only be used in a router table. Carbide tipped, two-wing cutter.

Part Number	Large Diameter	Cutting Length	Shank Diameter	Overall Length	Price
1/2" SHANK					
3370	5/8" - 1-1/4"	1-1/4"	1-1/4"	2-7/8"	\$285.33

* Order 3370 for Two Piece Set.

* Order 3370A or 3370B for individual cutters.



3373A 3373B



STRAIGHT TONGUE & GROOVE

Ball Bearing Guide

Straight Tongue & Groove bits are the ideal bits for joining two boards together where strength and alignment are important. This set makes the Tongue and Groove joint in its simplest form. Both sides of the joint are straight and square. Each side is formed with its own bit. This set works best when used in a router table with the fence in line with the bearing.

Carbide tipped, two-wing cutter.

Part Number	Large Diameter	Cutting Length	Shank Diameter	Overall Length	Price
1/2" SHANK					
3373	1/2" - 1-1/4"	1-1/4"	1-1/4"	3-1/8"	\$285.33

* Order 3373 for two piece set

* Order 3373A or 3373B for individual cutters.

Bearing Number: B7



GLUE JOINTS



VEE PANEL TONGUE & GROOVE Ball Bearing Guide



Vee Panel Tongue Straight Tongue & Groove bits are the ideal bits for joining two boards together where strength and alignment are important. This set makes the Tongue and Groove joint in its simplest form. Both sides of the joint are straight and square. Each side is formed with its own bit. This set works best when used in a router table with the fence in line with the bearing. Carbide tipped, two-wing cutter & Groove bits this set makes a tongue and groove joint with a decorative V groove along the length of the joint. It is typically used in tongue and groove paneling or ceilings. This set should only be used in a router table with the fence in line with the bearing. Carbide tipped, two-wing cutter

Part Number	Material Thickness	Large Diameter	Cutting Length	Overall Length	Price
1/2" SHANK					
3374	5/8-1"	1-5/8"	1"	2-3/4"	\$344.78

Order 3374 for two piece set.

Order 3374A or 3374B for individual cutters.

* Material over 1" thick requires a second cut on the tongue profile to waste away excess stock.

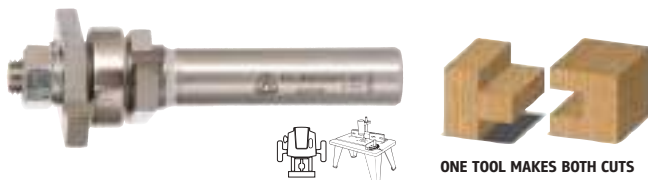

ONE TOOL MAKES BOTH CUTS

TONGUE & GROOVE ASSEMBLY

Tongue & Groove Assembly bit is the most economical way to make tongue and groove joints. The single bit is used to make both sides of the joint, simply by adjusting the height of the bit to change from tongue to groove. Carbide tipped.

Part Number	Material Thickness	Large Diameter	Cutting Length	Overall Length	Price
1/2" SHANK					
3375	1/2" - 13/16"	1-5/8"	9/32"	B5	\$133.16

Replacement Parts: Groover - 6628
Arbor - A260

EDGE BANDING SET

This bit set will allow the customer to make their own hardwood edge banding for plywood, particle board, or MDF stock. It enables them to make their own hardwood edge banding match the rest of the project instead of having to buy a thin veneer edge tape to be glued on. It's designed for stock up to 3/4" thick, which is standard sheet good thickness, and features carbide tips and 1/2" shank. The advantage of this is a stronger edge than that of the thin veneer tape. It can be routed with a profile or left square depending on the application. Adding hardwood banding to veneered plywood shelves and table tops.



- One bit will put a "V" shaped, concave profile in the plywood.
- While the other bit forms a perfect match in hardwood.
- Top and bottom of the banding can be trimmed flush using the router or hand plane.
- For use on stock that is less than 13/16" in thickness.

3401 Plywood Cutter • 3402 Edge Band Cutter

Part Number	Cutter Length	Material Thickness	Price
1/2" SHANK			
3400	13/16"	3/4"	\$209.25



MULTI SIDE BITS

A great way to join up many multi-side projects (planters, columns, barrels, etc.). Very straightforward, this joint requires routing a notch in only one edge of each stave (side). Notching also improves ease of assembly and total glue area. All bits are 1/2" shank and are designed for use in a router table with a fence guide.

Part Number	Number Of Sides	Stock (Maximum)	Large Diameter	Price
1/2" SHANK				
3506	6 or 12	7/8"	1-7/8"	\$111.75
3508	8	7/8"	1-3/4"	\$111.75

On six and eight sided objects, the exterior side is cut face up on a router table. Twelve and sixteen sided objects are cut face down. The same bit (#3506) is used for six sided and twelve sided objects.

Either Flush or Ribbed (outside corners protruding) construction is possible. Ribbed construction is recommended with 12 and 16 sides because the interior leg of the notch will be very small when made flush. Outside corners on ribbed construction can be cut or sanded down for flush appearance if desired.

Location of the inside corner of the notch (i.e. - vertical bit adjustment) is important for final finish appearance. The outside leg of the notch (closest to the exterior) should be the same length as the stock thickness for flush construction. This will put the inside corner of the notch in the center of the stave on six sided flush projects. The inside corner will be below center (furthest from exterior side) on all others. Allow extra stock to experiment and set corner height as desired. Move notch towards exterior side (raise the bit) to increase rib size (amount of outside corner protruding). Move notch away from exterior side (lower the bit) to decrease amount of rib. Note: Bit adjustment is reversed on twelve and sixteen sides since those staves are cut face down.

“
Couple these router bits with Klingspor's Glue Line Ripping saw blade to make all of your glue joint projects a breeze.
”

GROOVE PROFILES

Small Grooving Bits are commonly used for decorative designs in cabinet doors or for detail veining in furniture. Round Nose Bits and V-Groove Bits are often used in the same manner. The Larger Grooving Bits are great for a raised panel effect in doors and for adding a bold accent to furniture or large workpieces. These bits also make nice edge profiles with the aid of a router table and fence.

These bits are ideal for adding bearings to the shank for following templates. Select a bearing with the same inside diameter as your shank size. Outside diameter should be the same size or larger than the large diameter of your router bit. Secure bearings with a lock collar. Use Lock Collar #LC-1/4 for 1/4" shanks or LC-1/2 for 1/2" shanks.



CLASSICAL FLAT BOTTOM

Part Number	Radius	Large Diameter	Cutting Length	Overall Length	Price
1/4" SHANK					
3770	7/64"	3/4"	3/8"	2"	\$80.85
1/2" SHANK					
3780	13/64"	1-3/8"	9/16"	2-1/2"	\$118.90

PLUNGE OGEE

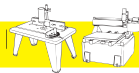

Part Number	Radius	"A" Small Diameter	"B" Large Diameter	"C" Cutting Length	Overall Length	Price
1/4" SHANK						
2051	3/16"	1/4"	5/8"	3/8"	1-3/4"	\$71.34
3602	3/32"	1/8"	1/2"	1/4"	1-3/4"	\$57.08
1/2" SHANK						
3606	3/16"	3/16"	7/8"	1/2"	2"	\$61.70
3608	3/16"	3/8"	1-1/8"	1/2"	2-1/4"	\$78.57



CLASSICAL ROUND BOTTOM

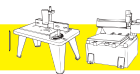

Part Number	Radius	Large Diameter	Cutting Length	Overall Length	Price
1/2" SHANK					
3735	3/16"	7/8"	1/2"	2-1/8"	\$80.85
3740	3/16"	1-1/8"	1/2"	2-1/8"	\$95.11
3750	7/32"	1-3/8"	9/16"	2-1/2"	\$118.90

“
Did you know that Klingspor has a full line of 10" and 12" high-quality industrial-grade saw blades?
 ”

- Our lineup includes:*
- Ripping
 - Glue Line Ripping
 - Combination
 - General Purpose
 - General Purpose Cutoff
 - Adjustable Scoring Set
 - Double-Sided Melamine
 - Fine Trim & Crosscut
 - Heavy Duty Miter/ Double Miter
 - Solid Surface Cutting
 - Plastic Cutting
 - Non-Ferrous Thin Wall (Under 1/4" thick)
 - Non-Ferrous Thick Wall (1/4" and a thicker)



MDF DOORS

The Tooling on this page is designed to give the illusion of raised panel door construction in MDF and solid panel doors. These bits, when used individually, produce a nice simple raised panel effect in one pass. Or use one of the "Panel" bits in conjunction with one of the "Stile" bits to create a more authentic raised panel reveal. Many different combinations are possible. See Bottom of Page. Although designed for production routing on solid door machines and CNC routers, the addition of a bearing to the shank will allow the hobbyist to cut his pattern by following an edge guide. The guide can be four strips clamped around the perimeter of the door. The top strip may be curved for an arched pattern. Follow the guide and rout both profiles. There's no need to move the guide for the second cut. A larger bearing on the panel bit takes care of the offset. Use Bearing #B16 for the Stile bits and Bearing #B24 for the Panel bits. Secure the bearings to the shank with a #LC-1/2 Lock Collar (see pg. 36). When making the second cut, match the depth setting of the first cut to obtain a pattern with a flat bottom - Or vary the depth to add an extra distinctive "step" in the bottom of your reveal. Complete the door by adding a door edge pattern (see Pg. 29) around the outside edge.



"STILE" PROFILE BITS



Part Number	Style	Large Diameter	Overall Length	Price
1/2" SHANK				
5610	Bead	7/8"	2-1/2"	\$109.38
5620	Traditional	1-1/4"	2-1/2"	\$118.90
5630	Ogee	1-1/4"	2-1/2"	\$118.90
5645	Straight	1-1/4"	2-1/2"	\$118.90

"PANEL" PROFILE BITS



Part Number	Style	Large Diameter	Overall Length	Price
1/2" SHANK				
5710	Cove	1-1/2"	2-1/2"	\$171.21
5720	Straight	1-1/2"	2-1/2"	\$171.21
5725	Ogee	1-1/2"	2-1/2"	\$171.21

STILE & PANEL COMBINATION PROFILES

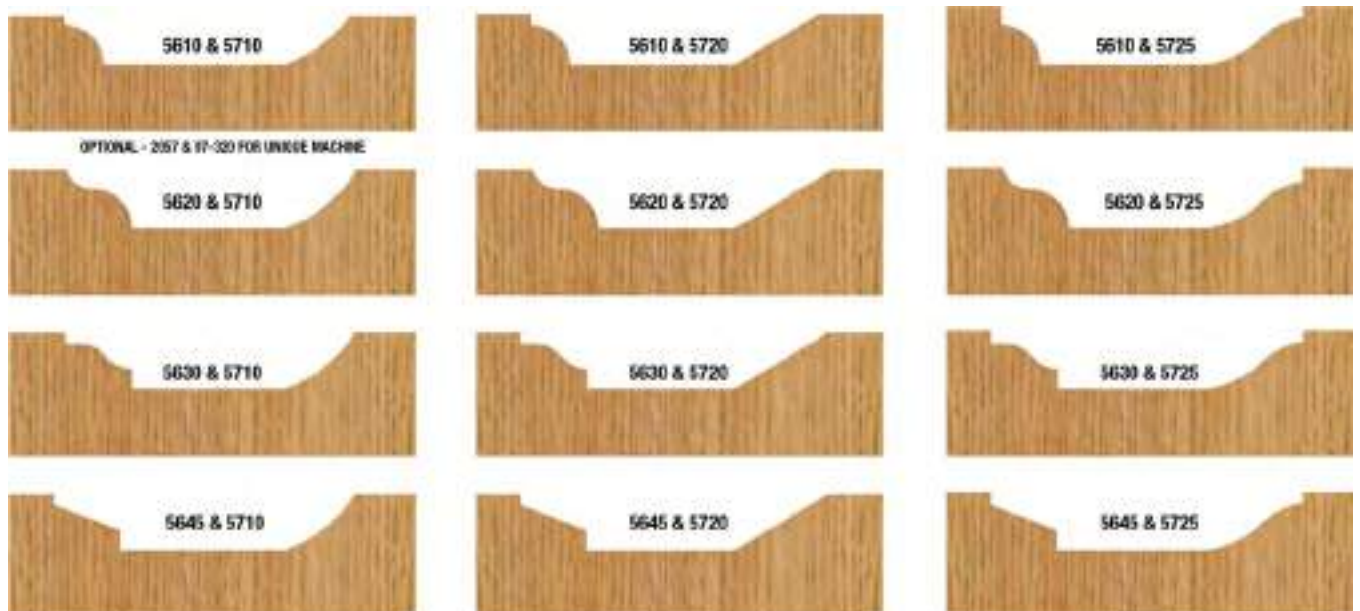

STILE & RAIL

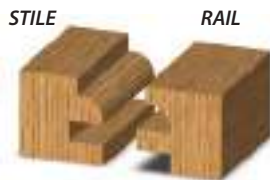

5740 - ROUND



5742 - OGEE

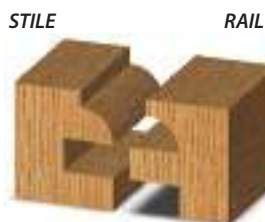

6001 - ROUND



6002 - OGEE



6003 - BEAD



6004 - STRAIGHT



6005 - TRADITIONAL



6006 - CLASSICAL

MINIATURE STILE & RAIL

These miniature Stile and Rail sets work just like their full size counterparts (see below). They feature a reduced pattern and a reduced tongue and groove (5/32" x 1/4") suitable for smaller projects. Works with 7/16" to 3/4" thick stock.

Set Number	Pattern	Reveal Width	Large Diameter	Stock Size	Price
1/2" SHANK					
5740	Round	3/16"	1-1/8"	7/16"-3/4"	\$332.90

For Individual Bits: Add A to Part Number for Stile Cutter.
Add B to Part Number for Rail Cutter.
Example: 5740A - Round Stile Cutter
Stile Groover - 5740AG
Rail Groover - 5740BG
Bearing - B27

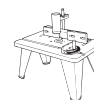

FULL SIZE STILE & RAIL

Make full size Stile and Rail joints on your router table. The interlocking design plus the raised panel groove are both cut in one pass. Ball bearing guides control the cutting depth and also allow use on rounded, arched, or special shaped doors. With these two piece sets, simply switch router bits to change from cutting stiles to cutting rails. Ideal for stock from 5/8" to 7/8" thick.



MATCHED SETS

Set Number	Pattern	Reveal Width	Cutting Length	Large Diameter	Price
1/2" SHANK					
6001	Round	1/4"	1"	1-5/8"	\$304.37
6002	Ogee	3/8"	7/8"	1-5/8"	\$304.37
6003	Bead	3/8"	7/8"	1-5/8"	\$304.37
6004	Straight	3/8"	7/8"	1-5/8"	\$304.37
6005	Traditional	3/8"	7/8"	1-5/8"	\$304.37
6006	Classical	3/8"	7/8"	1-5/8"	\$304.37

For Individual Bits: Add A to Part Number for Stile Cutter.
Add B to Part Number for Rail Cutter.
Example: 6001A - Round Stile Cutter
Replacement Parts: Groover - 6625
Bearing - B5

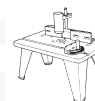

PLYWOOD PANEL STILE & RAIL

This set-up is for cabinet door construction with undersized 1/4" plywood panels. (Actual panel thickness of 7/32" or 5.5 mm). KLINGSPOR's conversion kit #6000X converts the regular full size Stile and Rail Bits to the narrower groove required for these plywood panels. This kit gives you the flexibility to do either plywood panels or raised panels. Plus, it can be used on any KLINGSPOR full size Stile and Rail bits that you may already own. Our two most popular Stile and Rail sets are also available ready to use just for plywood panel construction. Order Part Number 6001X for round pattern or Part Number 6002X for ogee pattern. 1/2" Shank only.

SHAKER STYLE STILE & RAIL

5990 \$233.03
DESCRIPTION: 7/32" Groove for undersized plywood

5991 \$417.09
DESCRIPTION: 6 mm Groove

5992 \$233.03
DESCRIPTION: 1/4" Groove



RAISED PANEL



MINIATURE RAISED PANEL BITS

1-3/4" Diameter - 1/2" Shank

Ball Bearing Guide \$173.32

These raised panel bits offer a reduced pattern ideal for smaller projects. Available in your choice of cove or ogee profile shown below. To work with the miniature stile and rail bits, set bit depth to leave a 5/32" thick tongue. Leaves only a 3/8" panel reveal after assembly! Now you can use raised panel construction for small doors, chests, jewelry boxes, etc.



LARGE RAISED PANEL BITS

5900 Series - 2 wing - 3-1/4" Diameter
6000 Series - 3 wing - 3-3/8" Diameter
1/2" Shank - Ball Bearing Guide



MEDIUM RAISED PANEL BITS

2-1/2" Diameter - 1/2" Shank Ball Bearing Guide

These bits cut a 1" wide pattern and are often used for general edge profiles in addition to raised panels. They can be used with the miniature or the full size stile and rail bits. See our great selection of profiles available at left.

LARGE RAISED PANEL BITS with BACK CUTTER

2 wing (2+2) - 3-1/4" Diameter
1/2" Shank - Ball Bearing Guide

This Panel Bit with Back Cutter allows you to cut the Front Reveal and the optional Back Cut at the same time - and guarantees a 1/4" tongue in the process.

CABINET DOORS

RAISED PANEL DOOR CONSTRUCTION

Choose stock size as appropriate for your project. For example, 3/4" x 2" stile & rails and 5/8" thick panels (without optional back cut) are common for cabinet doors. Use your stock size and door size to calculate the following:

- Stile length = Door height
- Rail length = Door width - width of both stiles + Interlock
- Panel height = Door height - width of both rails + Interlock - Expansion
- Panel width = Rail length - Expansion
- Interlock = 3/4" (3/8" per side) on KLINGSPOR full size Stile & Rail bits or 1/2" (1/4" per side) for KLINGSPOR miniature Stile & Rail.
- Expansion: Generally 1/8" on cabinet doors. Can vary with door size, green condition of wood, anticipated exposure to high humidity, and species of wood.
- Use the Stile bit to cut the entire length of the inside edge on both the stiles and the rails.
- Use the Rail bit to make the matching cross grain end cuts on the rails only.
- Use the Raised Panel bit to cut all four sides of each raised panel face down on the router table.

Set Raised Panel bit height for proper tongue thickness. Tongue should be 1/4" for the full size Stile & Rail bits or 5/32" for the miniature ones.

Allow extra stock if you plan to use the optional back cutter.

- Use the Standard Glue Joint or biscuits for added strength when gluing up larger panels.
- Cut all components and test fit. Then glue up and reassemble. Glue only the stile and rail joints. The panel should be allowed to "float" to allow for expansion and contraction. You may choose to use anti-rattle snakes to prevent the panel from rattling. Make your own by running a 1/8" bead of 100% silicone caulk on wax paper. Allow to dry. Cut into pieces about 3/4" long. Insert in each groove at every corner while assembling. Check the door for squareness immediately after gluing up. It may also be helpful to pre-stain the raised panel because part of the concealed portion of the tongue may become visible later due to contraction. Complete the door by adding a door edge pattern around the outside edge.



RAISED PANEL BACK CUTTER

This bit offers a safe and economical way to make that optional backside cut on raised panels. It is suitable for use with any of our Raised Panel Bits. 1-3/4" large diameter with 1/2" shank. **Order item #5850.**
\$123.64



STILE & RAIL GLASS DOORS



Make the Stile & Rail cuts for glass doors using KLINGSPOR's full size Stile & Rail Sets. No extra components are required. All that's needed is to stagger the cutting edges and "stack" both groovers on the Stile bit. Use both bearings (no groover) on the Rail bit. See Drawing. Now make your cuts just like in normal door construction.

Cut the inside edges of all four pieces with the Stile Bit. Trim the ends of the Rails with the Rail bit. Assemble door and insert glass pane. Use clips or corner trim mold on the back side to hold the pane in place.

\$233.02 / set



DOOR & DRAWER EDGE

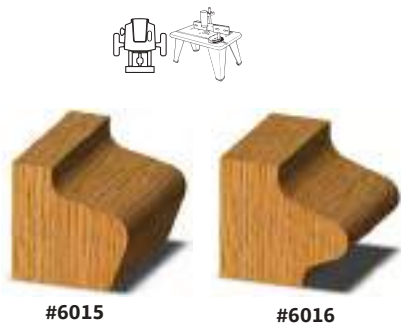

DOOR EDGE BITS Complete Edge

Door Edge Bits with the complete edge offer three options to choose from. The recessed profile creates an overhang to lip over the cabinet side or face frame. The finger pull produces a lip to grip the door from the back side for easier opening when no hardware will be used. The reversible, as the name implies, allows for a complete reversible finger pull to be milled on both sides of the door.

Part Number	Large Diameter	Cutting Length	Style	Price
1/2" SHANK				
6015	1-1/2"	7/8"	Finger Pull	\$130.78
6016	1-5/8"	15/16"	Reversible	\$156.04



DRAWER PULL - EUROPEAN STYLE

Drawer Pull – European style bits are a deeper style finger pull milled into the drawer front where hardware will not be installed.

Part Number	Large Radius	Large Diameter	Cutting Length	Overall Length	Price
1/2" SHANK					
6024	3/16"	3/4"	7/8"	2-3/8"	\$128.39
6026	1/4"	1-1/2"	13/16"	2-3/8"	\$141.48

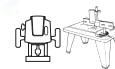

6032



DRAWER EDGE FINGER PULL

Produces a nice smooth finger grip primarily used on the bottom edge of drawer fronts. Also used as a finger pull on cabinet doors where no edge pattern is needed on the front face.

Part Number	Large Diameter	Cutting Length	Overall Length	Price
1/2" SHANK				
6032	1-1/4"	3/4"	2-1/2"	\$82.03

Bearing Number: B3



DOOR EDGE BITS

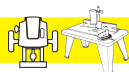

Front Face Edge Ball Bearing Guide

These bits cut a decorative profile along the front face of the door edge while leaving most of the edge straight. Their shallow design works well with concealed European style cup hinges. Many of our other edge profile bits also make great door edges. (Deeper profiles may not be compatible with European style cup hinges).

Part Number	Large Diameter	Cutting Length	Overall Length	Price
1/4" SHANK				
3290	1-3/8"	3/8"	1-7/8"	\$90.36
1/2" SHANK				
3292	1-3/8"	3/8"	2"	\$90.36
6020	1-9/16"	3/8"	2-1/4"	\$109.38
6021	1-3/4"	3/8"	2-1/4"	\$109.38
6022	1-3/4"	3/8"	2-1/4"	\$109.38
6023	1-3/4"	3/8"	2-1/4"	\$109.38



6045

6046

WINDOW SILL EDGE/ FINGER PULL

Originally designed to cut the front edge of window sills, this bit has also become popular for making a rounded finger edge on both drawers and door edges. Use with a router fence or add a shank mounted bearing for following a straight edge or template.

Part Number	Radius	Large Diameter	Profile Length	Overall Length	Price
1/2" SHANK					
6045	7/32"	1-1/4"	13/16"	2-7/8"	\$116.52
6046	3/8"	1-7/16"	1-1/8"	3-3/8"	\$141.48

Use Bearing (B16 for #6045, B18 for #6046) and Lock Collar (LC-1/2) on Shank for Template Work.



WINDOW SASH • DOVETAIL SETS

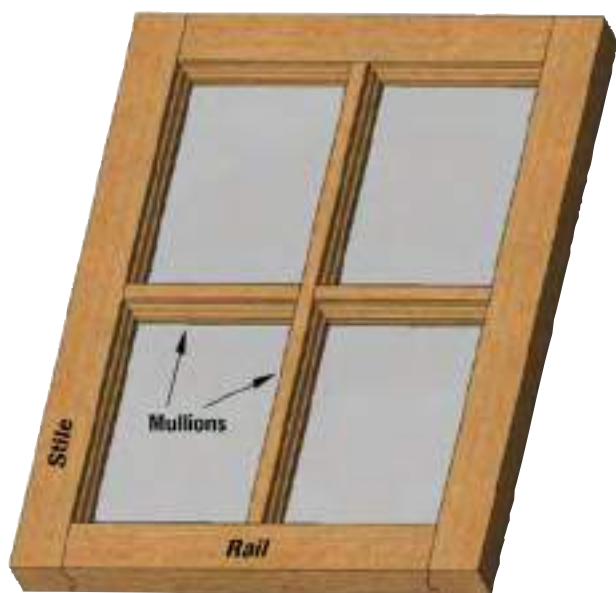

INCRA DOVETAIL SETS

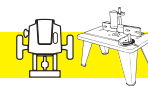

Top Quality Dovetailing Sets for use with the popular Incra System. Choose the #D101 Set (1/4" Shank) for the smaller Dovetails (1/4", 3/8", 1/2", 17/32"). Take the #605 Set (1/2" Shank) for the heavier 3/8", 1/2", 5/8", & 3/4" Dovetail bits. Both Sets also include the 1/4" and 3/8" Box Joint Bits.

Part#	Description	Price
D101	6 Piece Incra Set - 1/4" Shank	\$233.03
605	6 Piece Incra Set - 1/2" Shank	\$261.56

All bits available individually.

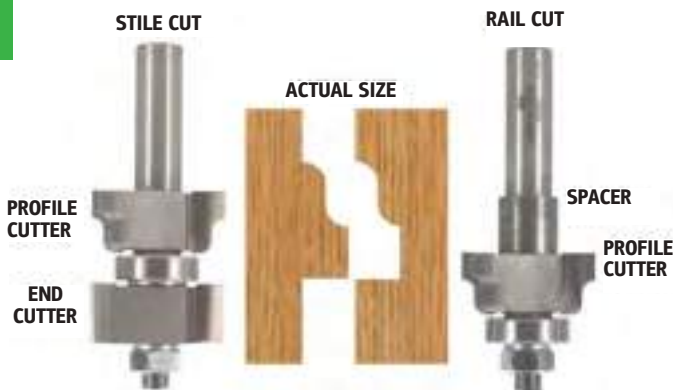

WINDOW SASH

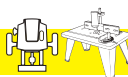

This is the only bit you need to make a complete window sash. The bearing guide controls the pattern depth and also allows you to make arched or curved windows and glass doors.

This assembly with the straight end cutter cuts the inside edges on both the stiles and rails. Convert the assembly to make the mating end cut by exchanging the straight cutter for the spacer (see drawing. The spacer can be installed between the profile cutter and the shank if additional reach across the workpiece is needed.) Now make the mating end cuts on the rails. This bit can also be used to cut both the decorative edges and the mating end cuts required to make your own window mullions (crosspieces).

Part Number	Cutting Diameter	Cutting Length	Overall Length	Price
6050	1-3/8"	7/8" - 1-5/8"	3-5/8"	\$242.53

Replacement Parts: Profile Cutter: 6050H

Arbor: A380

Bearing Number: B5

Straight Cutter: 6050G

Spacer: 6050SP

LEIGH DOVETAIL SETS

Upgrade to KLINGSPOR Quality Bits for your Leigh Jig. The smaller bits are supplied in the recommended 8mm Shanks (1/2" Adapter Collet is included). The largest sizes come in 1/2" shanks. Improved Performance Guaranteed.



Part#	Description	Price
D108	7 Piece Leigh Set. Includes D8-437x8, D8-687, D14-51x8, D18-50x8, 1020x8, 1067, and 6400x8 Adapter.	\$261.56
D116	6 Piece Leigh Set for #D1600 16" Jig. All bits 8mm Shank. 6400x8 Adapter Collet to 1/2" is included. Complete with the following bits: 1020x8, D8-375x8, D8-500x8, D14-51x8, D18-50x8 .	\$233.03

All bits available individually.



DOVETAIL BITS

DOVETAIL BITS

Premium Quality Dovetail Bits to meet all your Dovetailing Needs. Dovetail bits are popular for both their decorative and very functional joint. Made using a combination of a dovetail and a straight bit, these bits work well with many jigs manufactured on the market. Some bits are noted specifically to replace certain manufacturer's bits. These create a modern version of the hand cut dovetail used for centuries.

They are available in several angles from 7° to 18° and some sizes are made of solid carbide.



*with 1/2" shank only

Part Number	Large Diameter	Depth Of Cut	Shank Diameter	Overall Length	Cross Reference	Price
7° ANGLE						
D7-531	17/32"	3/4"	1/2"	2-1/2"	P•C #43776PC	\$52.30
D7-622	5/8"	7/8"	1/4"	2-3/8"		\$51.67
D7-625	5/8"	7/8"	1/2"	2-5/8"	Incra™	\$63.02
D7-750	3/4"	7/8"	1/2"	2-5/8"	Incra™	\$71.34
* D7-875	7/8"	7/8"	1/2"	2-1/2"	Stair Tread	\$81.31
7 1/2° ANGLE						
sc D75-25	1/4"	5/16"	1/4"	2-1/2"	Incra™/OmniJig® 43639	\$51.60
8° ANGLE						
sc D8-250	1/4"	1/4"	1/4"	2-1/2"	Leigh #50	\$52.80
sc D8-250x8	1/4"	1/4"	8mm	2-1/2"	Leigh #50-8mm shank	\$66.58
D8-375	3/8"	1/2"	1/4"	2-3/8"	Leigh #70	\$43.28
D8-375x8	3/8"	1/2"	8mm	2-3/8"	Leigh #70-8mm shank	\$49.93
D8-437	7/16"	5/8"	1/4"	2-3/8"	Leigh #75	\$50.89
D8-437x8	7/16"	5/8"	8mm	2-3/8"	Leigh #75-8mm shank	\$61.35
D8-500	1/2"	13/16"	1/4"	2-3/4"	Leigh #80	\$48.52
D8-500x8	1/2"	13/16"	8mm	2-3/4"	Leigh #80-8mm shank	\$58.74
D8-687	11/16"	1"	1/2"	3"	Leigh #90	\$58.74
D8-812	13/16"	1-1/4"	1/2"	3-1/4"	Leigh #100	\$63.02
9° ANGLE						
* D9-375	3/8"	3/8"	1/2"	2"		\$50.89
* D9-376	3/8"	3/8"	1/2"	2-1/2"	Incra™	\$52.80
* D9-390	.390	3/8"	1/2"	2"		\$50.89
10° ANGLE						
D10-50	1/2"	5/8"	1/4"	2-1/2"	Incra™/Leigh #101	\$47.44
D10-50x8	1/2"	5/8"	8mm	2-1/2"	Leigh #101-8mm shank	\$59.45
D10-55	1/2"	5/8"	1/2"	2-5/8"	Incra™	\$55.29
14° ANGLE						
D14-375	3/8"	3/8"	1/4"	2"		\$49.93
D14-50	1/2"	1/2"	1/4"	2"	Incra™/OmniJig® #43705	\$46.12
D14-51	1/2"	1/2"	1/4"	2-3/8"	Leigh #120	\$48.52
D14-51x8	1/2"	1/2"	8mm	2-3/8"	Leigh #120-8mm shank	\$58.02
* D14-55	1/2"	1/2"	1/2"	2-1/2"	Incra™/OmniJig® #43750	\$55.88
D14-531	17/32"	1/2"	1/4"	2"	Incra™	\$57.07
D14-72	3/4"	3/4"	1/4"	2-3/8"		\$44.06
D14-75	3/4"	3/4"	1/2"	3"	OmniJig® #43774	\$53.73
D14-100	1"	7/8"	1/2"	2-1/2"		\$86.80
18° ANGLE						
D18-50	1/2"	3/8"	1/4"	2-1/4"	Leigh #128	\$47.44
D18-50x8	1/2"	3/8"	8mm	2-1/4"	Leigh #128-8mm shank	\$59.21
STRAIGHT BITS						
1020	5/16"	1"	1/4"	2-3/4"	Leigh #140	\$38.32
1020x8	5/16"	1"	8mm	2-3/4"	Leigh #140-8mm shank	\$45.15
1064A	13/32"	1"	1/2"	2-1/2"	P•C #43743PC	\$41.38
1065L	7/16"	1-1/4"	1/2"	3-1/4"	Leigh #150	\$44.50
1067	1/2"	1-1/4"	1/2"	2-7/8"	Leigh #160	\$40.18

*Also Stocked in Left Hand. Add LH to Part Number. SC - Solid Carbide All bits designated Incra™ are also compatible with the JoinTech™ system

KELLER DOVETAIL BITS

KLINGSPOR Abrasives, Inc. offers precision router bits to match Keller's unique dovetailing system. All tools listed below are supplied with the required ball bearings.



Part Number	Keller Number	Large Diameter	Cutting Length	Shank Diameter	Overall Length	Price
7° ANGLE DOVETAIL						
K31	1631	11/32"	3/8"	1/4"	2-1/4"	\$83.22
K33	1633	7/16"	3/4"	1/4"	2-5/8"	\$85.61
K35	2435	5/8"	1"	3/8"	2-5/8"	\$109.38
STRAIGHT BITS						
K41	1641	5/8"	1/2"	1/4"	2-1/4"	\$71.34
K43	1643/2443	5/8"	3/4"	1/4"	2-1/2"	\$76.09
3015	2445	7/8"	1"	3/8"	2-5/8"	\$90.36
* 3032	1642	9/16"	3/4"	1/4"	2-1/4"	\$61.17

*Box Joint Bit

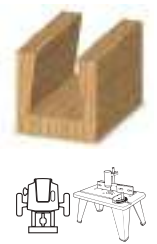

SPOILBOARD • SLOTTING

CNC SPOILBOARD SURFACING

CNC Spoilboard Surfacing bits are used to remove material from the scrap board so that the actual work piece can be milled on the CNC table without movement. Cutting applications include spoilboard, planing and rabbeting large surface areas in MDF, Balsa Core, hardwood, softwood and many other man-made materials. These spoilboard bits were engineered to produce a high quality cut, maximum cutting efficiency, faster material removal process and long tool life.



The industrial router bit features insert knives (three to four per bit) with four cutting edges that allow users to flip the knife over when one side becomes dull and is available in 1/2" and 3/4" shank size.



Choose straight cut for particle board and MDF surfacing or up-shear cut for balsa core material.

Part Number	Cut Diameter	Cutting Length	Shank Size	# Of Wings	Price
6220	2"	1/2"	1/2"	4	\$153.03

This bit does not have replaceable carbide tips

LARGE CNC

Part Number	Large Diameter	Shank Size	# of Wings	Price
-------------	----------------	------------	------------	-------

STRAIGHT CUT

SB25-2	2-1/2"	1/2"	2	\$722.86
SB40-2	4"	3/4"	2	\$751.39
SB40-3	4"	3/4"	3	\$808.45

UP SHEAR CUT

SBU25-2	2-1/2"	1/2"	2	\$808.45
SBU40-3	4"	3/4"	3	\$959.93



CARBIDE INSERTS

INDEXABLE - 4 CUTTING EDGES

Part Number	Description	Size	Price
SB-Insert	10 Pc. Insert Pak	14 mm x 14mm x 2mm	\$71.03
SB-Screw	Replacement Insert Screw	M5x7	\$8.09
SB-Wrench	Insert Wrench	T-15 Torx	\$19.02

STEEL ROUTER COLLETS

Reducer Bushings

Steel Router Collets are reducer bushings for common 3/4" or 1/2" router collets that allow for decreasing bit size to 3/8", 5/16", 8mm, or 1/4".

Part Number	I.D.	O.D.	Overall Length	Price
6400	1/4"	1/2"	1-1/4"	\$29.73
6400x8	8mm	1/2"	1-1/4"	\$29.73
6401	5/16"	1/2"	1-1/4"	\$29.73
6402	3/8"	1/2"	1-1/4"	\$29.73
6403	1/4"	3/4"	1-1/4"	\$42.80
6404	5/16"	3/4"	1-1/4"	\$42.80
6405	3/8"	3/4"	1-1/4"	\$42.80
6406	1/2"	3/4"	1-1/4"	\$35.67



SLOTTING CUTTERS

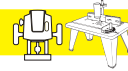

1-7/8" Cutting Diameter - 5/16" Bore

Slotting Cutters are designed to make slots (grooves) along the edges of boards and are far superior to straight bits for doing so. They are designed to be used with slotting cutter arbors and are available in a 3-wing or 4-wing design. Carbide tipped.



PART NUMBER	KERF	3 wing	4 wing	Decimal	Fractional	Price
6701A				.070	---	\$40.30
6702A				.080	---	\$40.30
6703A	6703B	.094	3/32"	\$39.82		
6704A		.100	---	\$45.66		
6704C		.110	7/64"	\$47.31		
6705A	6705B	.125	1/8"	\$44.85		
6708A		.156	5/32"	\$44.85		
6709A		.187	3/16"	\$44.85		
6709C		.218	7/32"	\$47.31		
6710A	6710B	.250	1/4"	\$44.85		
6712A		.281	9/32"	\$55.64		

Special Sizes Available Upon Request

SLOTTING CUTTER ARBORS



Includes B5 Bearing for 1/2" depth of cut.

Slotting Cutter Arbors with B5 bearing are for use with the slotting cutters. With the B5 bearing and slot cutter installed, the combo will achieve a 1/2" depth of cut.

Part Number	Shank Size	Overall Length	Price
A200B	1/4"	2-3/8"	\$21.02
A205B	3/8"	2-3/8"	\$25.78
A210B	1/2"	2-3/8"	\$21.02
A220B	1/2"	4"	\$38.86

Note - A220B has an extra long shank for extended reach. All include B5 Bearing for 1/2" depth of cut.

Use B20 Bearing for 9/16" depth of cut.

Use B25 Bearing for 3/8" depth of cut.

Use B26 Bearing for 1/4" depth of cut.

Use B27 Bearing for 5/8" depth of cut.

DRAWER SLOT CUTTERS

(Jemco Machines)

Drawer Slot Cutters are for use with and replacements for drawer slot cutter arbors and Jemco Machines and come with 4 or 6 Carbide tipped wings.



Part Number	Cutting Diameter	Bore	Kerf	No. Flutes	Price
6801	1-1/4"	3/8"-24thd	3/16"	6	\$71.34
6805	1-1/4"	3/8"-24thd	1/4"	6	\$71.34

DRAWER SLOT CUTTER ARBORS

Part Number	Shank Diameter	Overall Length	Thread	Price
6890	1/4"	2"	3/8"-24	\$19.02
6892	1/2"	2"	3/8"-24	\$19.02



DOWEL DRILLS • BORING BITS



10 mm Shank - Import

DOWEL DRILLS Carbide Tipped & Solid Carbide

Dowel Drills (brad point & V point) are made for production use in line boring, hinge boring, and dowel drilling machines. They are available in solid carbide, carbide tipped, and in left or right hand configurations. Available with a "brad point" style tip or a thru hole V-point.

BRAD POINT (RH + LH)

Cutting Diameter	57mm OAL Part #	70mm OAL Part #	Price
Inch 10 MM Shank - Inch Sizes			
3/16"	DB187-57 (LH)	DB187-70 (LH)	\$34.10
7/32"	DB218-57 (LH)	DB218-70 (LH)	\$34.10
1/4"	DB250-57 (LH)	DB250-70 (LH)	\$34.10
7/16"		DB437-70 (LH)	\$29.99
1/2"		DB500-70 (LH)	\$26.89
MM 10 MM Shank - Metric Sizes			
*3	DB3-57 (LH) SC	DB3-70 (LH) SC	\$27.79
4	DB4-57 (LH) (SC)	DB4-70 (LH) (SC)	\$29.99
5	DB5-57 (LH) (SC)	DB5-70 (LH) (SC)	\$26.89
6	DB6-57 (LH) (SC)	DB6-70 (LH) (SC)	\$27.79
7	DB7-57 (LH)	DB7-70 (LH)	\$34.72
8	DB8-57 (LH) (SC)	DB8-70 (LH) (SC)	\$29.03
9	DB9-57 (LH)	DB9-70 (LH)	\$39.72
10	DB10-57 (LH)	DB10-70 (LH)	\$38.93
11	DB11-57 (LH)	DB11-70 (LH)	\$51.90
12	DB12-57 (LH)	DB12-70 (LH)	\$44.63
13	DB13-57 (LH)	DB13-70 (LH)	\$61.85
14	DB14-57 (LH)	DB14-70 (LH)	\$68.93
15	DB15-57 (LH)	DB15-70 (LH)	\$73.77
16	DB16-57 (LH)	DB16-70 (LH)	\$73.77

RH and LH rotation. Include LH suffix for left hand rotation. Supplied with flat on shank. Include SC suffix for optional Solid Carbide as available. *3 mm available in Solid Carbide only.



THRU HOLE V-POINT (RH + LH)

Cutting Diameter	57mm OAL Part #	70mm OAL Part #	Price
Inch 10 MM Shank - Inch Sizes			
3/16"		DT187-70 (LH)	\$36.74
7/32"		DT218-70 (LH)	\$36.74
1/4"	DT250-57 (LH)	DT250-70 (LH)	\$36.74
3/8"		DT375-70 (LH)	\$44.78
7/16"		DT437-70 (LH)	\$35.04
1/2"		DT500-70 (LH)	\$67.64
MM 10 MM Shank - Metric Sizes			
*3	DT3-57 (LH) SC	DT3-70 (LH) SC	\$60.30
4	DT4-57 (LH) (SC)	DT4-70 (LH) (SC)	\$29.99
5	DT5-57 (LH) (SC)	DT5-70 (LH) (SC)	\$28.97
6	DT6-57 (LH) (SC)	DT6-70 (LH) (SC)	\$29.80
7	DT7-57 (LH)	DT7-70 (LH)	\$36.96
8	DT8-57 (LH) (SC)	DT8-70 (LH) (SC)	\$31.00
9	DT9-57 (LH)	DT9-70 (LH)	\$41.76
10	DT10-57 (LH)	DT10-70 (LH)	\$34.96
11	DT11-57 (LH)	DT11-70 (LH)	\$44.78
12	DT12-57 (LH)	DT12-70 (LH)	\$46.79
13	DT13-57 (LH)	DT13-70 (LH)	\$53.32
14	DT14-57 (LH)	DT14-70 (LH)	\$57.10
15	DT15-57 (LH)	DT15-70 (LH)	\$38.34

RH and LH rotation. Include LH suffix for left hand rotation. Supplied with flat on shank. Include SC suffix for optional Solid Carbide as available. *3 mm available in Solid Carbide only.

HINGE BORING BITS

Carbide Tipped

10 mm Shank - Import

Hinge Boring Bits are used with hinge boring machines bore specific hinge cup sizes.

Carbide Tipped

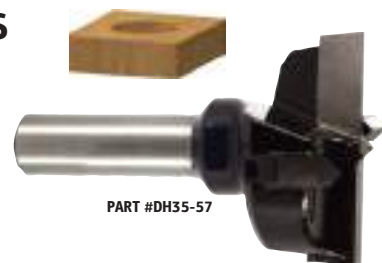

Cutting Diameter	57mm OAL Part #	70mm OAL Part #	Price
MM 10 MM Shank			
15	DH 15-57 (LH)	DH 15-70 (LH)	\$87.13
20	DH 20-57 (LH)	DH 20-70 (LH)	\$75.87
25	DH 25-57 (LH)	DH 25-70 (LH)	\$83.95
30	DH 30-57 (LH)	DH 30-70 (LH)	\$91.39
35	DH 35-57 (LH)	DH 35-70 (LH)	\$92.86

RH and LH rotation. Include LH suffix for left hand rotation. Supplied with flat on shank.

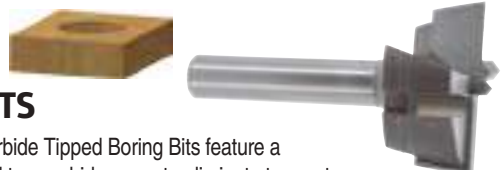

BORING BITS

KLINGSPOR's Carbide Tipped Boring Bits feature a centering point and two carbide spurs to eliminate tear out. The 2-1/8" diameter bit is used mostly for door knob holes. The 35mm diameter bit is widely used for European style cabinet door hinges.

Part Number	Cutting Diameter	Shank Diameter	Overall Length	Price
8122125	2-1/8"	1/2"	6-1/8"	\$487.72
6140	35mm	3/8"	2-3/8"	\$114.13

** Use only in drill press or boring machine. NOT for use in routers.



FACE FRAME COUNTERBORES

Carbide Tipped Face Frame Counterbores are KLINGSPOR's answer to the "cheap" pocket hole bit replacements. These are designed to work with industry standard machines have replaceable pilots and counterbores. See notes below.

Part Number	Counter Diameter	Bore Diameter	Pilot Length Type	Overall Length	Price
3/8" SHANK					
FF301	3/8"	.136 4"	Standard	4"	\$80.84
FF301SP	3/8"	.136 4"	Spiral Flute	4"	\$97.01
FF302	3/8"	.136 6"	Long	6"	\$140.90
FF303	Replacement	.136 Pilot Fishtail Drill Bit (HSS)			\$13.80
FF304	Replacement Set Screw	Uses 5/64 Hex Key			\$0.67



Castle Machines/Porter-Cable

Part Number	Counter Diameter	Bore Diameter	Pilot Length Type	Overall Length	Price
CM-DB		9/64"	Pilot		\$27.52
CM-RU	3/8"		Pocket		\$55.04
* RU4000H	3/8"		Pocket		\$121.27

Standard Type fits Unique, Norfield, Evans, Ritter, and Marcon face frame boring machines. Long Version is for use on drill press. * Super High Quality

DOWEL DRILLS • BORING BITS

NEW!

HIGH-SPEED STEEL COUNTERSINK BITS

An exciting new addition to Klingspor's high-quality router bit line

Our NEW HIGH-SPEED STEEL countersink bits add to the quality offerings of our extensive Klingspor Router Bit line. High-speed steel will provide longer life when cutting wood or metal. The #6, #8, or #10 82-degree heads are designed to slide onto the drill bit and fasten into place using dual set screws that lock into the gullets. The drilling length can be adjusted by sliding the head up or down the bit and tightening it in place.

8070006	High-Speed Steel Countersink for #6 screws	\$36.58
8070008	High-Speed Steel Countersink for #8 screws	\$36.58
8070010	High-Speed Steel Countersink for #10 screws	\$38.70
8061416	Pilot bit for 8070006 (9/64")	\$5.98
8061728	Pilot bit for 8070008 (11/64")	\$6.49
8062010	Pilot bit for 8070010 (13/64")	\$7.65

**DOOR-LITE BIT**

Single Flute - Up/Down • Designed for Metal Clad Doors

DOOR-LITE BIT

(Coated High Speed Steel Single Flute Up/Down Cut)

PART#	CED	CEL	SHANK DIA	OAL	PRICE
HC 5250	1/2"	2-1/2"	1/2"	5-1/2"	\$104.63
HCF5250	With Flat on Shank				\$109.38

DOOR-LITE BIT - WOOD & FIBERGLASS DOORS

(Solid Carbide Compression)

PART#	CED	CEL	SHANK DIA	OAL	PRICE
UD5222	1/2"	2-1/4"	1/2"	5-1/2"	\$302.12

THE SECRET

Traditional downcut spiral door bits on the market "BLOW OUT" material on the bottom side of the door after the bit dulls. KLINGSPOR's Up/Down Door-Lite bit continues to perform after dulling because the material is "pulled" up instead of being pushed down. The bits are made with high grade American tool steel and precision ground on state of the art CNC grinders.

ASTOUNDING RESULTS

Tests were conducted of the KLINGSPOR Up/Down Door-Lite Bit against traditional downcut spiral door bits. Test cuts were performed on a CNC door cutting machine routing steel clad exterior doors. The traditional bit cut an average of 12,000 inches per bit, whereas the KLINGSPOR Door-Lite bit cut an amazing 22,000 inches! * Ideal operating specifications: 3,500 rpm @ 400 ipm



ROUTER BIT SETS

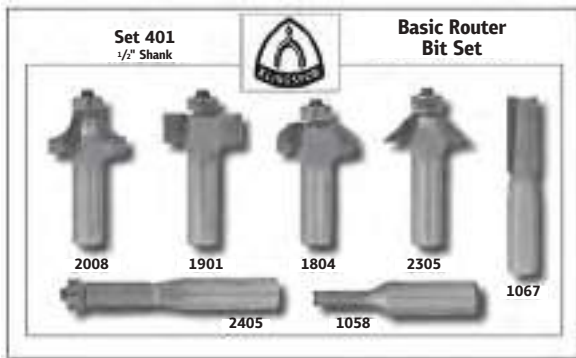

Set 401 - BASIC 7 Pc. Bit Set - 1/2" Shank \$261.56
Set 402 - BASIC 7 Pc. Bit Set - 1/4" Shank \$261.56

This is the set pictured on the back cover. It's made up of only the most popular woodworking bits. Includes our 1/4" Straight, 1/2" Straight, R3/8 Roundover, 3/8" x 1/2" Rabbet, R3/8 Cove, 45° Chamfer, and 1/2" Flush Trim.

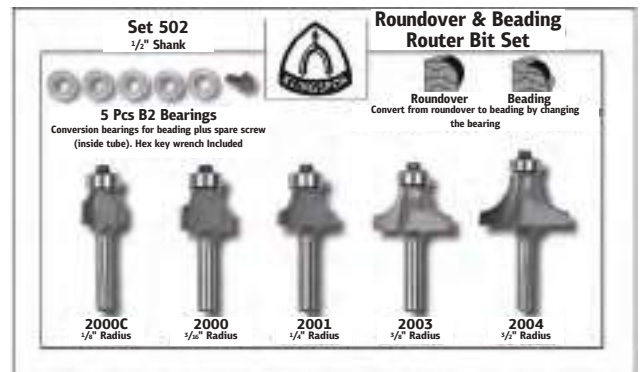

Set 502 - ROUNDOVER & BEADING - 1/4" Shank \$261.56
 Easily round off all your square edges with lightweight 1/4" capacity Hand Routers. Keep the whole range of sizes (R1/8, R3/16, R1/4, R3/8, R1/2) neatly organized and right at your fingertips. As with the 1/2" shank set, this kit comes fully equipped to extend its usage by converting to Beading - i.e., Roundover with a decorative step.



Set 470 - 3 PC. UNDERSIZED PLYWOOD DADO ROUTER BIT SET - 1/2" SHANK \$123.64

These 3 "go-to" router bits are sized to exactly match today's nominal plywood thicknesses. Make everything fit just right while saving over buying bits separately!



Set 600 - STRAIGHT & HALF ROUND COMBO - 1/2" Shank \$499.33

A nice collection of Straight Bits and Half Rounds grouped together in one protective case. This set includes:

- 3/8 Straight
- 1/2 Straight
- 3/8 Half Round
- 1/2 Half Round
- 5/8 Straight
- 3/4 Straight
- 5/8 Half Round
- 3/4 Half Round

This handy group covers the full assortment of bits needed for the INCRA® Hinge Crafter. KLINGSPOR Industrial Quality.

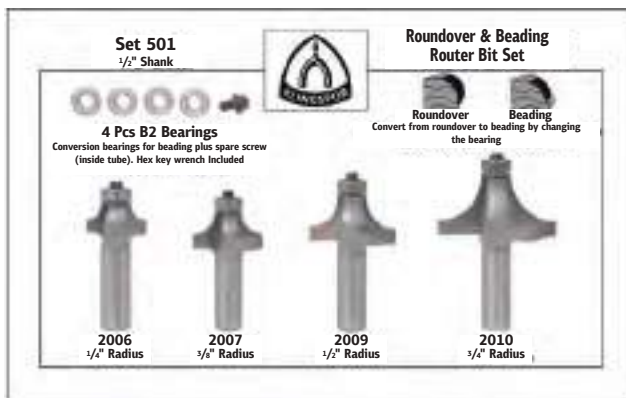

Set 501 - ROUNDOVER & BEADING - 1/2" \$261.56

Shank Roundovers are by far the most used Edge forming bits in woodworking. This set offers the most common Radii (R1/4, R3/8, R1/2) in 1/2" shanks, plus a hefty 3/4" Radius workhorse. Extra bearings and wrench are included to convert each bit from Rounding over to Beading - i.e., Roundover with a decorative step.



Set 703 - 3 PIECE BALLNOSE \$219.73

Includes: SC66, RU1800RN, RU2075RN



Set 705 - 5 PIECE CNC STARTER SET

\$357.56

Includes:

SC64, SC66, RU2075, 1502, 1550

ACCESSORIES



9500 - SOLID BRASS INLAY KIT

KLINGSPOR's brass inlay kit allows you to make perfect fitting inlays for decoration or repairs. Simply cut your template from 1/4" thick material and trace it with your router to cut both the cavity in your workpiece and the matching inlay to be inserted. Instructions are included. Our kit includes a special centering pin to insure exact alignment with router spindle. Also includes a 1/8" Solid Carbide Spiral Router Bit (Part# RD1600).

Part #	Description	Price
	Inlay Kit	
RD1600	1/8" Solid Carbide Router Bit	\$107.88

QUICK CHANGE CHUCKS

Swap router bits quickly and easily. Cam-lock design clamps and loosens with a partial turn using a hex key wrench. Much simpler than the original two wrench method. Holds 1/2" shank bits. Order #6400 Router Collet for 1/4" shanks. Replace the factory collet with a Quick Change.

Part #	Description	Price
9710	All 1/2" Bosch	\$209.26
9720	Dewalt 625/Elu 1/2"/Fein/Festool/Freud	\$209.26

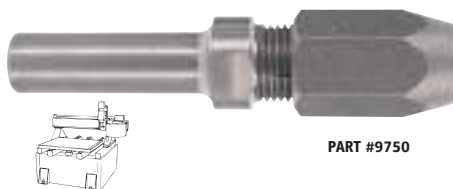

9750 - EXTENSION ADAPTER

For CNC Carving Machines

Used for light routing and veining on CNC carving machines. Allows deeper reach. Adapter is 1/2" shank. Accepts 1/4" shank bits only. Order Part #9750.

HEX KEY WRENCHES

Part#	Size	Application	Price
HK-1/16	1/16"	Bearing Lock Collars	\$2.38
HK-5/64	5/64"	1/8" I.D. Bearings (3-48 Screw)	\$2.38
HK-3/32 *	3/32"	3/16" I.D. Bearings (5-40 Screw)	\$2.38
HK-5/32	5/32"	1/4" I.D. Bearings (10-32 Screw)	\$2.38

* Standard Size for Most Bits



9600 - SQUARE CORNER CHISEL

Use this tool to square up the round corners left behind when routing hinge mortises. Hold unit in mortise corner and strike with hammer. Our chisel features a sharp 3/8" square hardened steel cutting blade.

9600-B Replacement Blade \$17.55



BRASS SET-UP GAUGE BLOCKS

Our Square Gauge Blocks are a quick way to make many easy, accurate set-ups. A great way to make exact depth movements on plunge routers. On table routers, they're perfect for setting distances from the fence to the cutter, or for checking the bit height above the table. Supplied in 1/8", 3/16", 1/4", 3/8", and 1/2" squares. Blocks can be "stacked" to cover a wider range of sizes. A very helpful tool!

Part#	Description	Price
9800	5 pc. Set - 2-1/2" Long	\$28.09
9810	5 pc. Set - 4" Long	

9510 - BASE PLATE REDUCERS - SOLID BRASS



These solid brass inserts fit into your router base plate to reduce the gap around the router bit. Not only is this safer, but it also reduces tearout and helps support smaller workpieces. Supplied in a set with openings of 1/4", 3/8", 1/2", 5/8", 3/4", 7/8", and 1", plus retaining nut. Openings are slightly oversize for tool clearance. Fits any router with a standard 1-3/16" diameter recessed hole for template guides.

SPARE PARTS LISTING

Flat Washers - 10 pc. pack

Part Number	Inside Diameter	Outside Diameter	Thickness	Price
31250W	5/16"	1/2"	1/16"	\$19.02

Replacement Parts By Tool Number

Replacement Bearing sizes are listed in the catalog with each tool. Most tools with bearing pilots on the end require only the 54025S Screw. Exceptions:

34825S Screw:	2400,2401,2404A
103238S Screw	2013-2016, 2410, 2415, 2560, 2570, 2575, 2580, 2715, 2900-2908, 3390
1032N Nut	RFT5125, RFTD5125, RFT5200 RFTD5200, UDFT5152



Socket Head Cap Screws - 10 pc. pack

Part Number	Thread Size	Thread Length	Hex Key Size	Price
34825S	3-48	1/4"	5/64"	\$0.95
54025S	5-40	1/4"	3/32"	\$0.90
103238S	10-32	3/8"	5/32"	\$0.95

Add BLK to part number for 100 pcs.

Hex Nuts - 10 pc. pack

Part Number	Thread Size	Thread Length	Hex Key Size	Price
1032N	10-32"	1/4"	3/8"	\$11.90
31224N	5/16-24"	1/4"	1/2"	\$11.90



ACCESSORIES

ARBORS



Part Number	Shank Diameter	Arbor Diameter	Arbor Length	Overall Length	Price
A200	1/4"	5/16"	7/8"	2-3/8"	\$10.71
A205	3/8"	5/16"	7/8"	2-1/2"	\$16.64
A210	1/2"	5/16"	7/8"	2-5/8"	\$10.70
A220	1/2"	5/16"	7/8"	4"	\$28.53
A250	1/4"	5/16"	1-3/16"	2-3/4"	\$14.27
A260	1/2"	5/16"	1-3/16"	2-7/8"	\$14.27
A300	1/4"	5/16"	1-7/16"	3"	\$15.46
A310	1/2"	5/16"	1-7/16"	3-3/16"	\$14.27
A375	1/2"	5/16"	1-3/4"	3-3/8"	\$21.39

Arbors include nut and washer.



W300 - SHIM WASHER KIT \$28.53

Use these shim washers to fine adjust the spacing on any arbor or assembly with a 5/16" diameter arbor (Slot Cutters, Stile & Rail, Window Sash, Tongue & Groove). Washers are 5/16" I.D. x 1/2" O.D. Includes three each of the following thicknesses: .004, .006, .008, .010, .012.

BEARING LOCK COLLARS

Retaining Collars used when bearings are added to the shanks of router bits for following templates.

Part Number	Shank Diameter	Outside Diameter	Price
LC-1/4	1/4"	7/16"	\$7.73
LC-1/2	1/2"	11/16"	\$7.73

Uses part # HK-1/16 Hex Key Wrench

#LCS-Replacement Set Screw for Lock Collars



BALL BEARINGS



Part Number	Outside Diameter	Inside Diameter	Application	Price
B1A	1/4"	1/8"		\$14.27
B1	3/8"	1/8"		\$11.90
B2	3/8"	3/16"		\$10.70
B3	1/2"	3/16"	Standard	\$10.70
B3-BLK	1/2"	3/16"	100 pcs. bulk	\$772.79
B3S	1/2"	3/16"	Non-Mar Nylon Sleeve	\$19.62
B3SQ	1/2"	3/16"	Euro-Square (Pg. 15)	\$15.46
B3T	1/2"	3/16"	Teflon® Shields	\$13.08
B3U	.490"	3/16"	for resharps (undersize)	\$13.08
B4	3/4"	1/4"		\$9.52
B5	7/8"	5/16"		\$9.52
B6	5/8"	1/4"		\$9.52
B7	5/8"	3/16"		\$10.46
B8	3/4"	3/16"		\$14.27
B8SQ	3/4"	3/16"	Euro-Square (Pg. 15)	\$15.46
B9	1/2"	1/4"		\$11.90
B9U	.490"	1/4"	for resharps (undersize)	\$17.83
B11	1-1/8"	1/2"		\$11.90
B12	7/8"	3/8"		\$19.02
B13	7/8"	1/2"		\$24.97
B14	11/16"	3/16"		\$20.21
B15	13/16"	3/16"		\$22.59
B16	1-1/4"	1/2"		\$38.04
B17	1-3/8"	1/2"		\$38.04
B18	1-1/2"	1/2"		\$38.04
B19	3/4"	1/2"		\$29.73
B20	3/4"	5/16"		\$23.78
B21	7/8"	1/4"		\$33.29
B24	1-7/8"	1/2"		\$45.18
B25	1-1/8"	5/16"		\$35.67
B26	1-3/8"	5/16"		\$35.67
B27	5/8"	5/16"		\$21.39
B28	7/8"	3/16"		\$26.16
B29	1"	3/16"		\$26.16
B33	9/16"	3/16"		\$28.53
BB300	7/8" X 10°	3/16"	Non-Mar Nylon Sleeve	\$44.94
1955T	1/2"	3/16"	Sleeve for B11	\$10.71
BB315	7/8" X 15°	3/16"		\$40.42
BB318	7/8" X 18°	3/16"		\$39.45

BB501 - 5 PIECE BEARING CONVERSION KIT



Use this kit to vary the horizontal cutting depth of router bits with bearing pilots.

Great for stepping in to finish depth by controlled increments.

Contains B2 (3/8"), B3 (1/2"), B7 (5/8"), B8 (3/4") Bearings and 3/32" Hex Key Wrench **\$35.67**

BB600 - GENERAL BEARING REPAIR KIT

This handy kit includes spare bearings, screws, and wrench to replace bearings on most bits.

Includes five B3 (1/2" x 3/16") and two B2 (3/8" x 3/16") bearings, ten 54025S Screws, and a 3/32" Hex Key Wrench. **\$49.93**

BB701 - ACCESSORY KIT \$114.13

Great for replacement bearings and screws - Plus this generous bearing assortment allows you to vary your cutting depths and change your profiles. Also contains lock collars and bearings for adding bearing guides to the shanks of your standard bits for following templates.

Contains: 12 bearings - four B3 (1/2" x 3/16"), one each of B2 (3/8" x 3/16"), B7 (5/8" x 3/16"), B8 (3/4" x 3/16"), B9 (1/2" x 1/4"), B6 (5/8" x 1/4"), B4 (3/4" x 1/4"), B5 (7/8" x 5/16") and B11 (1 1/8" x 1/2"); two each 1/4" lock collars (LC-1/4) and 1/2" lock collars (LC-1/2); one each 1/16", 5/64", 3/32" and 5/32" Hex Key wrenches; plus ten 54025S bearing screws.

SAW BLADES

RIPPING



TABLE SAW

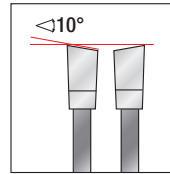
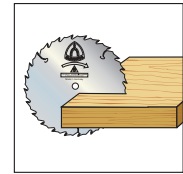
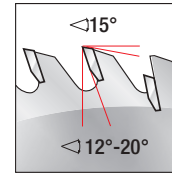

GANG RIP SAW

ATB GRIND
MODERATE ANGLESOFT & HARDWOOD
RIPPING

This blade is specifically designed for efficient, smooth ripping. The low tooth count and large gullets combine to make this blade fast and aggressive. This is suitable for use in table saws or gang-rip saws.

Dia.	Teeth	Kerf		Plate		Hook Angle	Bore	Pin-Hole	Tool No.	Price
		MM	Inch	MM	Inch					
10"	24	3.2	.126	2.2	.087	20°	5/8"	—	KSB10-240	\$89.49
10"	24	2.38	.094	1.8	.071	20°	5/8"	—	KSB10-240TKT	\$75.63

WARNING: Not recommended for cutting non-ferrous alloys, plastic, laminate and melamine.

GLUE LINE RIPPING



TABLE SAW

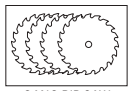

GANG RIP SAW

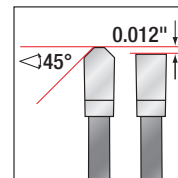

TC GRIND

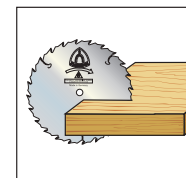
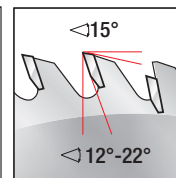
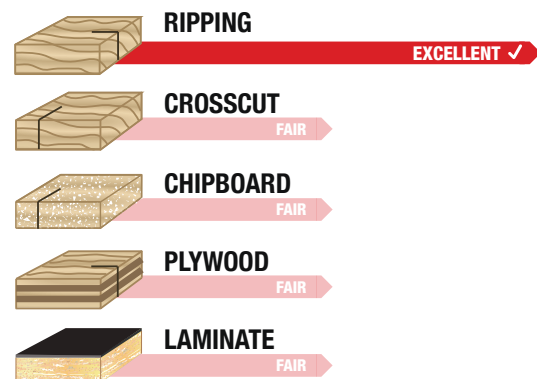
SOFT & HARDWOOD
RIPPING

This special glue line blade shears the wood cleanly so there is no need to joint the stock prior to gluing. The precision triple-chip grind & extra-high hook angle allow aggressive feed rates, yet produce an extra-smooth cut finish. The thick plate and laser cut expansion slots minimize vibration. Use on table saws, sliding table saws, single and gang-rip operations.

Dia.	Teeth	Kerf		Plate		Hook Angle	Bore	Pin-Hole	Tool No.	Price
		MM	Inch	MM	Inch					
10"	32	3.7	.145	2.5	.098	12°	5/8"	—	KSB10-301	\$127.69

WARNING: Not recommended for cutting non-ferrous alloys, plastic and melamine.



SAW BLADES

COMBINATION

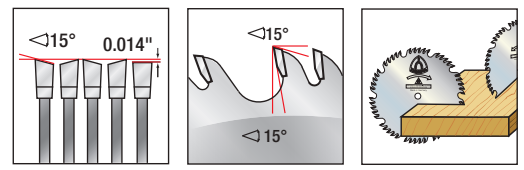
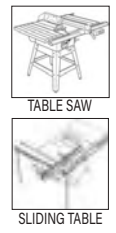

COMB 4+1 GRIND
FOUR ATB FOLLOWED BY ONE RAKER, THEN AN "OPEN" GULLET FOR CHIP CLEARANCE

COMBINATION RIP & CROSSCUT

- CROSSCUT** EXCELLENT ✓
- RIPPING** EXCELLENT ✓
- CHIPBOARD** GOOD
- PLYWOOD** GOOD

In many woodworking shops one blade must cut a wide variety of materials. This blade will effectively rip and crosscut hardwoods, softwoods, as well as sheet stock such as plywood and particleboard. It features the time-tested combination blade design - four alternate top bevel teeth with a flat-top raker. This is the best blade for all-purpose cutting.

Dia.	Teeth	Kerf		Plate		Hook Angle	Bore	Pin-Hole	Tool No.	Price
		MM	Inch	MM	Inch					
10"	50	3.2	.126	2.2	.087	15°	5/8"	—	KSB10-500	\$117.18
10"	50	2.38	.094	1.8	.071	15°	5/8"	—	KSB10-504TKT	\$105.91

WARNING: Not recommended for cutting non-ferrous alloys.

GENERAL PURPOSE

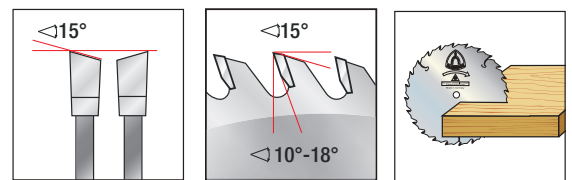

ATB GRIND MODERATE ANGLE

SOFT & HARDWOOD CROSSCUT

- RIPPING** GOOD
- CROSSCUT** GOOD
- PLYWOOD** GOOD
- CHIPBOARD** FAIR

In some cases, a customer doesn't want to change blades from ripping to crosscutting to rough cutting in a variety of materials. A good general purpose blade usually fits the bill, as it works pretty well on different materials and applications.

Dia.	Teeth	Kerf		Plate		Hook Angle	Bore	Pin-Hole	Tool No.	Price
		MM	Inch	MM	Inch					
10"	40	3.2	.126	2.2	.087	15°	5/8"	—	KSB10-400	\$104.57

WARNING: Not recommended for cutting non-ferrous alloys, plastic and melamine.

SAW BLADES

PLYWOOD / LAMINATE CUTOFF

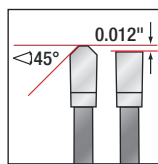

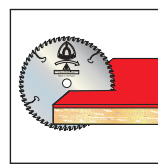
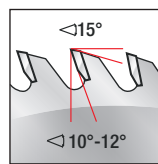

TC GRIND FOLLOWED BY FLAT RAKER

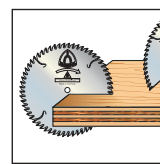

PLASTIC LAMINATE SINGLE SIDED

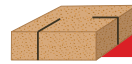

PLYWOOD

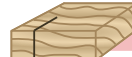
-  **LAMINATE (Single Sided)** EXCELLENT ✓
-  **MDF** EXCELLENT ✓
-  **CHIPBOARD** EXCELLENT ✓
-  **PLYWOOD** GOOD
-  **CROSSCUT** FAIR

These blades are specifically designed for clean cuts in single-sided plywood laminates. The greater number of teeth, triple-chip grind and 10°-12° hook angle provide an excellent balance between feed resistance and finish. This leaves a clean finish on the top side of the plywood or plastic laminate materials. Some table saws require special scoring blades (KSB120-T14 see below) in conjunction with the KSB12-721-30 below to accomplish clean cuts on double sided laminates.

Dia.	Teeth	Kerf		Plate		Hook Angle	Bore	Pin-Hole	Tool No.	Price
		MM	Inch	MM	Inch					
10"	60	3.2	.126	2.2	.087	12°	5/8"	—	KSB10-601	\$121.60
10"	80	3.2	.126	2.2	.087	10°	5/8"	—	KSB10-801	\$151.55
12"	72	3.2	.126	2.2	.087	12°	1"	—	KSB12-721	\$164.08
300mm	72	3.2	.126	2.2	.087	10°	30mm	—	KSB12-721-30	\$164.08

† 30mm bore accepts pin-hole arrangements of: 2/10/60, 2/7/42 & 2/9/46.

WARNING: Not recommended for cutting non-ferrous alloys and melamine.

ADJUSTABLE SCORING SETS

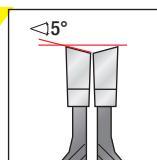

ATB GRIND MODERATE ANGLE

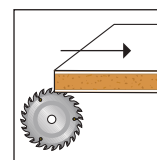
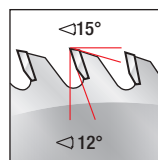

SCORING PARTICLE BOARD & DOUBLE SIDED MDF LAMINATE

-  **DOUBLE-SIDED MELAMINE** EXCELLENT ✓
-  **PLASTIC LAMINATE** EXCELLENT ✓

Used on panel saws and sliding table saws (ex. SCM, & Altendorf), with separate scoring units for chip-free cuts on both sides of the material. Adjustable scoring sets consist of two 12-tooth saw blades with shims to adjust the kerf width (2.8mm to 3.6mm). These are used in combination with our plywood/ laminate series Triple chip blade above.

Dia.	Teeth	Kerf		Plate		Hook Angle	Bore	Pin-Hole	Tool No.	Price
		MM	Inch	MM	Inch					
120mm	12x2	2.8-3.6	.110-.144	2.2(x2)	.087(x2)	12°	22mm	—	KSB120-T14	\$193.06

WARNING: Not recommended for cutting non-ferrous alloys.



SAW BLADES

DOUBLE-SIDED
MELAMINE

TABLE SAW

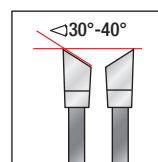
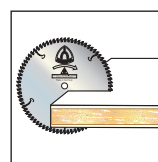
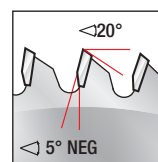
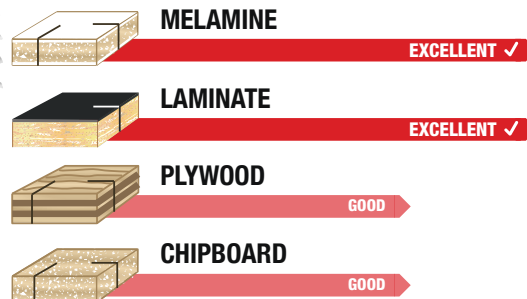

SLIDING TABLE

H-ATB GRIND
HIGH OR ACUTE ANGLE ALTERNATIVE
TOP BEVELMELAMINE SINGLE &
DOUBLE SIDED

This blade is designed for smooth crosscuts in a variety of materials from hardwoods, softwoods and sheet stock including chipboard. Not intended for sliding miter or radial arm saw applications.

Dia.	Teeth	Kerf		Plate		Hook		Pin-Hole	Tool No.	Price
		MM	Inch	MM	Inch	Angle	Bore			
10"	80	3.2	.126	2.2	.087	-5°	5/8"	—	KSB10-803	\$180.36
12"	96	3.2	.126	2.5	.100	-5°	1"	—	KSB12-963	\$216.45



WARNING: Not recommended for cutting non-ferrous alloys.

TERMINOLOGY

- Blow out:** A condition in which the saw blade blows out the grain of a workpiece.
- Chipping:** A condition that occurs when the saw blade lifts and tears the wood fibers as it exits the material.
- Crosscutting:** Cutting wood against the grain.
- Cut off:** Cutting a piece to length (Same as Crosscut)
- Hook Angles:** The amount of forward or backward lean each tooth has. The angle is measured by the intersection of two imaginary lines. The first line is drawn flush with the face of the tooth, the second line is drawn vertically through the center of the arbor hole.
- Kerf:** The width of the cut made when the blade passed through the material, determined by the width of the tooth.
- Miter:** A finish cut made at an angle.
- Negative Hook Angle:** The negative face of the tooth is much less likely to cause chipping in the surface of the material because it is oriented in a counter-rotation direction. This will prevent self feeding.
- Non-Ferrous:** Any metal not containing iron.
- Positive Hook Angle:** The higher the hook angle, the more aggressive the blade will cut the material. This is great for getting through a lot of material fast.
- Ripping:** Cutting wood in the same direction as the grain.
- Run out:** The amount of wobble in a saw blade, also known as warp.
- Thick Wall:** Cutting a non ferrous metal over 1/4" thick
- Thin Wall:** Cutting a non ferrous metal under 1/4" thick

SAW BLADES

FINE TRIM & CROSSCUT

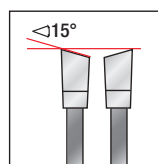

ATB GRIND
MODERATE ANGLE

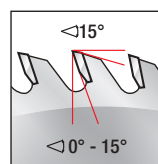

SOFT & HARDWOOD
PLYWOOD

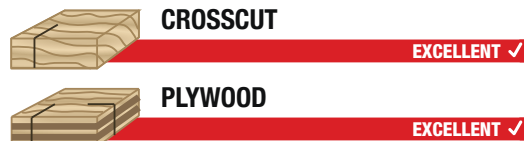

! WARNING: Not recommended for cutting non-ferrous alloys, plastic, laminate and melamine.

Dia.	Teeth	Kerf		Plate		Angle	Hook	Bore	Pin-Hole	Tool No.	Price
		MM	Inch	MM	Inch						
10"	80	3.2	.126	2.2	.087	10°		5/8"	—	KSB10-800	\$143.49
12"	96	3.2	.126	2.2	.087	10°		1"	—	KSB12-960	\$187.85

HEAVY-DUTY MITER/ DOUBLE MITER

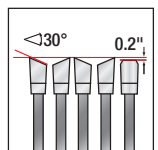

4 H-ATB + 1 TCG GRIND
FOUR HIGH ALTERNATE TOP BEVEL
FOLLOWED BY ONE TRIPLE CHIP GRIND

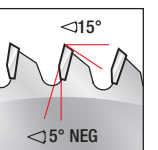

MITER

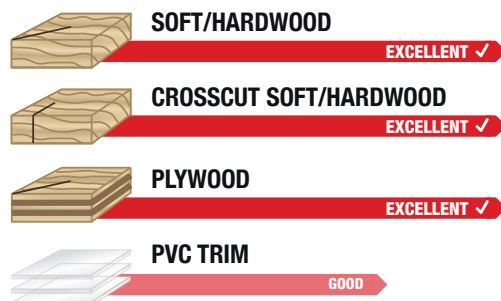

! WARNING: Not recommended for cutting non-ferrous alloys.

The KLINGSPOR Heavy-Duty Single/Double Miter blades were designed especially for glass smooth compound miters cuts in moldings or picture frame stock for use in a miter box, radial arm, and single/double miter saws. This style blade is the perfect choice for picture frame and millwork shops.

Dia.	Teeth	Kerf		Plate		Angle	Hook	Bore	Pin-Hole	Tool No.	Price
		MM	Inch	MM	Inch						
10"	80	3.0	.118	2.5	.098	-5°		5/8"	—	KSB10-806	\$146.95
12"	100	3.0	.118	2.5	.098	-5°		1"	—	KSB12-106	\$195.44
10"	60	2.4	.094	1.8	.071	-5°		5/8"	—	KSB10-606TKT	\$105.91
10"	80	2.3	.090	1.8	.071	0°		5/8"	—	KSB10-816TKT	\$121.05
12"	72	2.4	.094	1.8	.071	-3°		1"	—	KSB12-726TKT	\$151.34



SAW BLADES

SOLID SURFACE

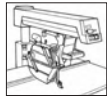

RADIAL SAW



TABLE SAW



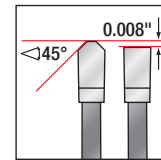

SLIDING TABLE

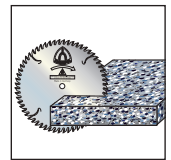
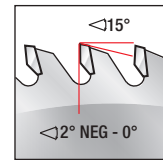

M-TC GRIND

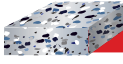

SOLID SURFACE

-  **SOLID SURFACE** EXCELLENT ✓
-  **PLEXIGLAS®/VINYL** EXCELLENT ✓
-  **LAMINATE** GOOD

This blade is specifically designed for cutting plastic laminate, Plexiglas®, and solid surface materials such as Avonite®, Dupont Corian®, Wilsonart®, Gibraltar®, Earthstone® Fountainhead®, Surrell®, Staron® and other acrylic based materials. The triple chip grind is especially configured to leave a swirl-free cut in solid surface materials. The thick, stable plate reduces vibration that degrades the cut and shortens tool life. The blade is suitable for a variety of saw configurations and its 0° hook angle virtually eliminates self-feeding when it is used with a radial arm saw.

Dia.	Teeth	Kerf		Plate		Hook Angle	Bore	Pin-Hole	Tool No.	Price
		MM	Inch	MM	Inch					
10"	72	3.2	.126	2.2	.087	0°	5/8"	—	KSB10-728	\$176.55

! WARNING: Not recommended for cutting non-ferrous alloys.

PLASTIC



TABLE SAW



SLIDING TABLE

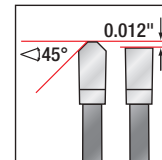

M-TC GRIND

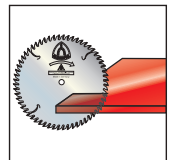
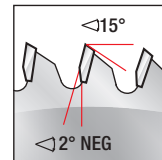

PLASTIC

-  **PLASTIC** EXCELLENT ✓
-  **THIN-WALLED PHENOLIC & HARD PLASTIC** EXCELLENT ✓
-  **LAMINATE** GOOD

Designed for smooth, chip-free cutting of plastics, these blades have a higher tooth count and will work fantastic in thinner material. They are also suitable for crosscutting, trimming, and mitering wood and work well for plywood and laminate cutting.

Dia.	Teeth	Kerf		Plate		Hook Angle	Bore	Pin-Hole	Tool No.	Price
		MM	Inch	MM	Inch					
10"	80	2.5	.098	1.8	.071	-2°	5/8"	—	KSB10-802	\$201.53

! WARNING: Not recommended for cutting non-ferrous alloys.

SAW BLADES NON-FERROUS FOR THIN WALLED ALUMINUM



TABLE SAW



RADIAL SAW



MITER SAW

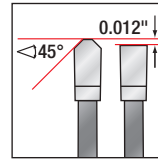

TC GRIND

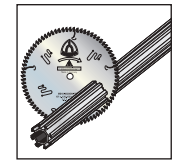
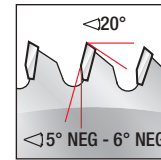

NON-FERROUS ALLOYS

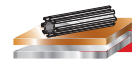

NON-FERROUS ALLOYS

EXCELLENT ✓



THIN-WALLED PHENOLIC & HARD PLASTIC

EXCELLENT ✓



ALUMINUM

EXCELLENT ✓



BRASS/COPPER

EXCELLENT ✓

Designed specifically for cutting relatively thin-walled aluminum and non-ferrous extrusions and frames on table or miter saw applications. Use a coolant or blade wax and clamp down the work piece when cutting non-ferrous metals. (<1/4")

Dia.	Teeth	Kerf		Plate		Angle	Hook	Bore	Pin-Hole	Tool No.	Price
		MM	Inch	MM	Inch						
10"	80	3.2	.126	2.5	.098	-5°		5/8"	7,600	KSB10-805	\$201.53
12"	100	3.2	.126	2.5	.098	-5°		1"	6,200	KSB12-105	\$267.66

WARNING: Never attempt to cut ferrous metals (steel, iron, etc.) with these blades.

NON-FERROUS FOR THICK WALLED ALUMINUM



TABLE SAW

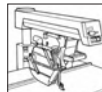

RADIAL SAW



MITER SAW

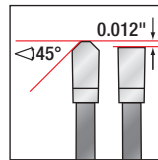

TC GRIND

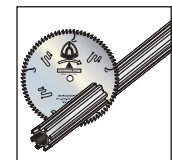
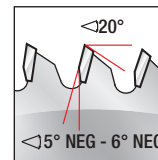

NON-FERROUS ALLOYS

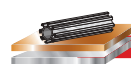

NON-FERROUS ALLOYS

EXCELLENT ✓

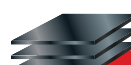

THIN-WALLED PHENOLIC & HARD PLASTIC

EXCELLENT ✓

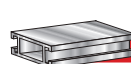

ALUMINUM

EXCELLENT ✓



BRASS/COPPER

EXCELLENT ✓

The special carbide formulation and blade geometry makes this blade ideal for cutting aluminum and non-ferrous metal bars such as copper, brass, bronze and lead. They are also, good for cutting relatively thick-walled extrusions and profiles. The negative hook angle, triple-chip grind and thick plate combine to produce a superior finish. Use a coolant or blade wax and clamp down the work piece when cutting non-ferrous metals. The blade can be used to cut other "difficult" materials such as plastic, PVC tubing and fiberglass on table or miter saw applications. (<1/4")

Dia.	Teeth	Kerf		Plate		Angle	Hook	Bore	Pin-Hole	Tool No.	Price
		MM	Inch	MM	Inch						
10"	60	3.2	.126	2.5	.098	-6°		5/8"	7,600	KSB10-605	\$202.28



SAW BLADE APPLICATION GUIDE

SOLID WOOD:

- RIP:** KSB10-240 - More aggressive, faster & leaves a rougher cut
 KSB10-301 - Less aggressive and better edge finish
 KSB10-240TKT - Thin Kerf
- Crosscut:** KSB10-800 / KSB12-960 (For use on a table saw)
 KSB10-500
 KSB10-806 / KSB12-106 (For use on Miter saws, sliding miter saws & Radial Arm)
- Combo** (Rip & crosscut wood, plywood, chipboard):
 KSB10-500 Better overall results on solid wood
 KSB10-400 More aggressive and faster for rough cutting in wood
 KSB10-504TKT - Thin Kerf

PLYWOOD:

- KSB10-601 (Single-sided only - may chip on the back side)
 KSB10-801 (same blade, but with more teeth - 80 vs 60)
 KSB12-721 & 721-30 (Single-sided only - may chip the back side)
 KSB10-800 (Different tooth configuration - ATB - and better for double-sided & prefinished plywood applications).
 Also good for crosscutting solid wood.

LAMINATE (single sided):

- KSB10-728 Solid surface blade
 KSB10-802 Plastic blade
 KSB10-803 / KSB12-963 Melamine blade

MDF/Chipboard:

- KSB10-801 Plywood/Laminate
 KSB10-803 / KSB12-963 Melamine blade

MELAMINE:

- KSB10-803 / KS12-963

PLASTIC:

- KSB10-802 (Phenolic & hard plastics)
 KSB10-728 (Plexiglass)
 KSB10-805 / KSB12-105 (Phenolic, Hard plastics & aluminum)

NON-FERROUS (Brass, copper, aluminum, etc.):

- KSB10-805 / KSB12-105 (Thin wall - less than 1/4")
 KSB10-605 (Thick wall - greater than 1/4")

MITER CUTS:

- KSB10-806 10" Miter Blade
 KSB12-106 12" Miter Blade
 KSB10-816TKT 12" Thin Kerf Miter
 KSB10-606TKT 10" Thin Kerf Sliding Miter
 KSB12-726TKT 12" Thin Kerf Sliding Miter

KLINGSPOR GUARANTEE & WARRANTY: KLINGSPOR warrants to the original purchaser at retail that each new saw blade shall be free from defects in material and workmanship. Upon verification of failure or malfunction, KLINGSPOR shall, at its option, within forty five (45) days of purchase, replace the saw blade, subject to the Guidelines below. • In the event of failure or malfunction, return the product, properly packaged and postage prepaid, to KLINGSPOR. Please call KLINGSPOR at 800 645-5555. • KLINGSPOR assumes no liability for defects or damage caused by abuse or misuse of any product or unauthorized service of any product. The product must have been used for its recommended purpose and not modified by sharpening or other changes. Normal wear and tear is not covered under KLINGSPOR warranties.

JIGSAW BLADES

Blade Characteristics



x0x - Standard

The grain is sliced as the tooth shape is positioned slanted relative to the wood. As the ground flanks do not make contact with the saw kerf, the cut made in the wood is very clean.

Application: Wood



x1x - Special

Long service life due to carbide-tipped teeth. The width of the saw blade allows for straight and precise cuts. Even the hardest materials are cut with high speed.

Applications: Aerated concrete, masonry, hollow brick



x3x - Double-sided toothing

Allows for extremely tight curve cuts, and even reverse cuts, in wood

Applications: Softwood, plywood, particle boards



x4x - Back-toothed

Long service life due to carbide-tipped teeth. The width of the saw blade allows for straight and precise cuts. Even the hardest materials are cut with high speed.

Application: Wood



x5x - Narrow

The narrow shape of the jigsaw blade allows for curve cuts in wood.

Applications: Wood

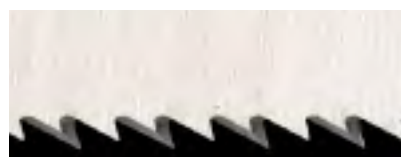

x6x - Push-to-cut

Jigsaw blades with "push-to-cut toothing" allow for splinter-free cuts on the material surface thanks to their "reversed toothing".

Application: Wood, kitchen countertops, coated boards



x7x - Radial toothing

The three different orientations of the teeth ensure a tear-free cut on both sides.

Applications: Kitchen countertops, coated boards



x8x - Thick saw blade

The extra thickness of the jigsaw blade also ensures a cut with angle accuracy.

Application: Wood



x9x - Vario toothing

Jigsaw blades with alternating tooth pitch guarantee universal use across a wide range of materials.

Applications: Wood, wood with nails, metal, steel



JIGSAW BLADES

Wood-based materials

Wood/Hardwood



Softwood



Coated Boards

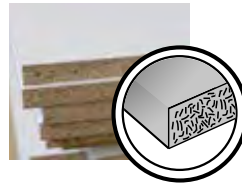

Kitchen Countertops



Plywood

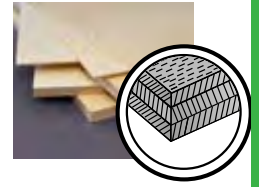

Multiplex



MDF/Particle Board



Greenwood



Firewood



Laminate



Pallets

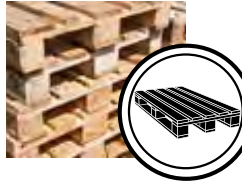

Metals

Stainless Steel



Steel



Aluminum

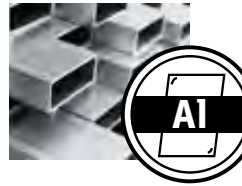

Universal Metals



Metal Pipe



Construction Materials

Plastic

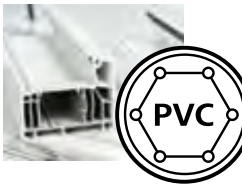

Fibre-Reinforced Plastics



PVC Pipe



Sandwich Material

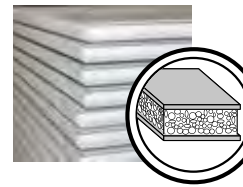

Wood With Nails



Aerated Concrete

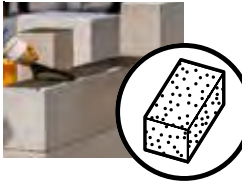

Fibre-Reinforced Brickwork

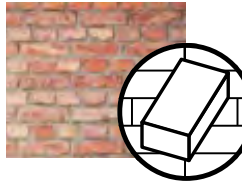

Stone

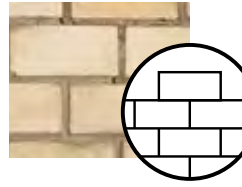

HFL (High Pressure Laminate)

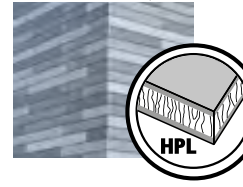

JIGSAW BLADES AVAILABILITY

Jig Saw Blades	Wood											Metal						Plastics							
	Softwood	Hardwood	HPL Board	Construction Wood	Coated Sheet Goods	Countertops	Plywood	Multiplex	Core Board	MDF	Chipboard	Trespa Board	Wood With Nails	Laminate	Sheet Metal	Steel	Stainless Steel	Steel Sheets	Non-Ferrous Metal	Aluminum	Metal Composites	Plastic	Fibre-reinforced Plastic	Epoxy	PC Boards
670547	X					X	X	X	X	X	X														
670549	X					X	X	X	X	X	X														
670540	X						X	X	X	X	X														
670542	X						X	X	X	X	X														
670541	X						X	X	X	X	X														
670551		X	X				X		X		X	X													
670546	X			X	X	X	X	X	X																
670533	X			X	X	X	X	X	X																
670537	X			X	X		X							X											
670543					X									X								X			X
670550					X									X								X			X
670498														X	X	X	X								
670417													X	X	X	X	X	X							
670530														X	X	X	X	X	X						
670532															X				X	X			X		
670527		X											X		X	X		X	X				X	X	

RECIPROCATING SAW BLADES AVAILABILITY

Recip Saw Blades	Wood									Metal					Plastics		
	Softwood	Hardwood	Greenwood	Firewood	Construction Wood	Plywood	Chipboard	Wood With Nails	Pallets	Sheet Metal	Steel	Stainless Steel	Non-Ferrous Metal	Aluminum	Plastic	Fibre-reinforced Plastic	Epoxy
670464	X				X	X	X								X		
670476	X				X	X	X								X		
670435							X	X								X	X
670421							X	X								X	X
670341								X	X	X	X	X	X			X	X
670352								X	X	X	X	X	X			X	X
670359								X	X	X	X	X	X			X	X
670415									X	X	X	X	X				
670434									X	X	X	X	X				
670496	X		X	X	X												
670479	X		X	X	X												
670472	X		X	X	X												



JIGSAW BLADE STYLES

Cutting Properties

Extra Clean Cut

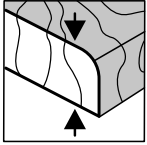

Rough Cut

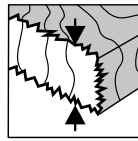

Curve Cuts

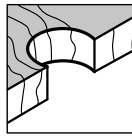

Rough Curve Cut

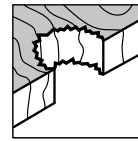

Quick Cut



Angle-accurate

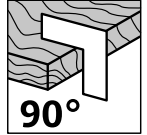

Splinter-free on both sides

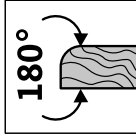

Switch off pendulum stroke

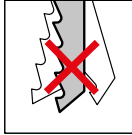

Straight cut - wood

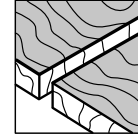

Straight cut - metal

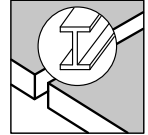

Blade and Tooth Properties

Extra strong blade

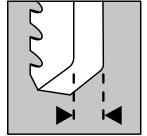

Angle-accurate cuts

Three-sided diamond cut

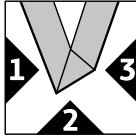

For clean cuts in wood

Vario tothing

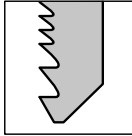

Cuts in different materials

Push-to-cut

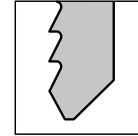

Splinter-free cuts on the material

Back-toothed

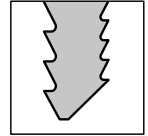

Fine and extra clean curve

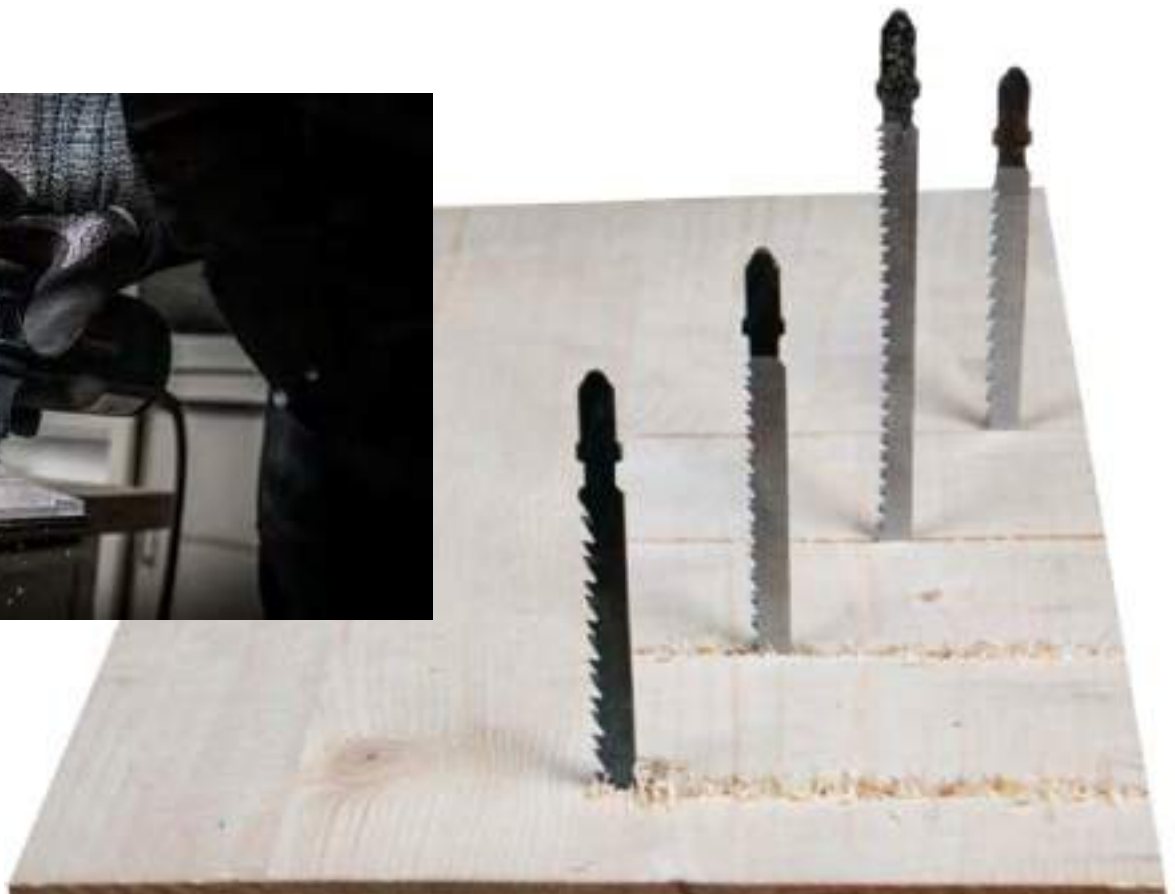

JIGSAW BLADES



Jigsaw blade **670547**

JS 302 WQ WOOD

Advantages: Very fast, rough cuts in almost all wood materials - Top seller with very good price-performance ratio.

Properties:	
Class	T-shaft
Design	Crossground, set
Material	Chromium-vanadium

Applications:	
Softwood	●
Construction wood	●
Kitchen worktop	●
Plywood	●
Chipboard	●
Blockboard	●
Multiplex boards	●
MDF	●

Width x Length x Thickness	Cutting Length	Teeth Per Inch	For material thickness	Packing	Item Number	Price
4" x 5/16" x 3/64"	3"	6	3/16" - 2"	5	670547	\$14.35



Jigsaw blade **670549**

JS 352 WQ WOOD

Advantages: Very fast, rough curved cuts in almost all wood materials - Top seller with very good price/performance ratio

Properties:	
Class	T-shaft
Design	Crossground, set
Material	Chromium-vanadium

Applications:	
Softwood	●
Construction wood	●
Kitchen worktop	●
Plywood	●
Chipboard	●
Blockboard	●
Multiplex boards	●

Width x Length x Thickness	Cutting Length	Teeth Per Inch	For material thickness	Packing	Item Number	Price
4" x 5/16" x 3/64"	3"	10	1/8" - 1-1/4"	5	670549	\$15.35



Jigsaw blade **670540**

JS 601 WF WOOD

Advantages: Very clean, straight cuts in wood and wood-based materials

Properties:	
Class	T-shaft
Design	Crossground, tapered
Material	Chromium-vanadium

Applications:	
Softwood	●
Construction wood	●
Plywood	●
Blockboards	●
Chipboard	●
Multiplex boards	●
MDF	●

Width x Length x Thickness	Cutting Length	Teeth Per Inch	For material thickness	Packing	Item Number	Price
4-1/2" x 5/16" x 3/64"	3-1/2"	10	3/8" - 2-1/2"	5	670540	\$17.44

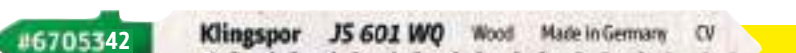

Jigsaw blade **670542**

JS 601 WQ WOOD

Advantages: Very clean, straight and fast cuts in wood and wood-based materials

Properties:	
Class	T-shaft
Design	Crossground, tapered
Material	Chromium-vanadium

Applications:	
Softwood	●
Construction wood	●
Kitchen worktop	●
Plywood	●
Chipboard	●
Blockboard	●
Multiplex boards	●
MDF	●

Width x Length x Thickness	Cutting Length	Teeth Per Inch	For material thickness	Packing	Item Number	Price
4-1/2" x 3/16" x 1/16"	3-3/4"	6	1/8" - 2-3/8"	5	670542	\$34.93

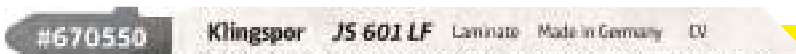

Jigsaw blade **670550**

JS 601 LF LAMINATE

Advantages: Very clean, straight and chip-free cuts on both sides in plastic and plastic-coated materials - Top seller for laminate and vinyl parquet flooring

Properties:	
Class	T-shaft
Design	Crossground, tapered
Material	Chromium-vanadium

Applications:	
Laminate	●
Plastic	●
Laminated panels	●
Floor layer	●
Woodworking craft	●

Width x Length x Thickness	Cutting Length	Teeth Per Inch	For material thickness	Packing	Item Number	Price
5/16" x 3-5/16" X 1/16"	2-15/16"	17	1/8" - 1-3/16"	5	670550	\$24.45

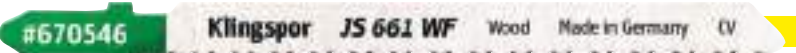

Jigsaw blade **670546**

JS 661 WF WOOD

Advantages: Very clean, straight cuts in wood and wood-based materials - Clean edges on the visible side due to butt serration - Especially for coated boards and kitchen worktops

Properties:	
Class	Supra

Applications:		Materials:	
Softwood	●	Furniture industry	●
Construction wood	●	Kitchen cabinet makers	●
Kitchen worktop	●	Multiplex boards	●
Plywood	●		

Width x Length x Thickness	Cutting Length	Teeth Per Inch	For material thickness	Packing	Item Number	Price
4" x 5/16" x 3/64"	3"	10	3/16" - 2"	5	670546	\$14.35



JIGSAW BLADES

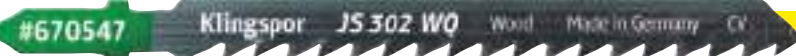

Jigsaw blade **670547**

JS 302 WQ WOOD

Advantages: Very fast, rough cuts in almost all wood materials - Top seller with very good price-performance ratio.

Properties:	
Class	T-shaft
Design	Crossground, set
Material	Chromium-vanadium

Applications:	
Softwood	●
Construction wood	●
Kitchen worktop	●
Plywood	●
Chipboard	●
Blockboard	●
Multiplex boards	●
MDF	●

Width x Length x Thickness	Cutting Length	Teeth Per Inch	For material thickness	Packing	Item Number	Price
4" x 5/16" x 3/64"	3"	6	3/16" - 2"	5	670547	\$14.35



Jigsaw blade **670549**

JS 352 WQ WOOD

Advantages: Very fast, rough curved cuts in almost all wood materials - Top seller with very good price/performance ratio

Properties:	
Class	T-shaft
Design	Crossground, set
Material	Chromium-vanadium

Applications:	
Softwood	●
Construction wood	●
Kitchen worktop	●
Plywood	●
Chipboard	●
Blockboard	●
Multiplex boards	●

Width x Length x Thickness	Cutting Length	Teeth Per Inch	For material thickness	Packing	Item Number	Price
4" x 5/16" x 3/64"	3"	10	1/8" - 1-1/4"	5	670549	\$15.35



Jigsaw blade **670540**

JS 601 WF WOOD

Advantages: Very clean, straight cuts in wood and wood-based materials

Properties:	
Class	T-shaft
Design	Crossground, tapered
Material	Chromium-vanadium

Applications:	
Softwood	●
Construction wood	●
Plywood	●
Blockboards	●
Chipboard	●
Multiplex boards	●
MDF	●

Width x Length x Thickness	Cutting Length	Teeth Per Inch	For material thickness	Packing	Item Number	Price
4-1/2" x 5/16" x 3/64"	3-1/2"	10	3/8" - 2-1/2"	5	670540	\$17.44

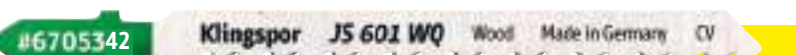

Jigsaw blade **670542**

JS 601 WQ WOOD

Advantages: Very clean, straight and fast cuts in wood and wood-based materials

Properties:	
Class	T-shaft
Design	Crossground, tapered
Material	Chromium-vanadium

Applications:	
Softwood	●
Construction wood	●
Kitchen worktop	●
Plywood	●
Chipboard	●
Blockboard	●
Multiplex boards	●
MDF	●

Width x Length x Thickness	Cutting Length	Teeth Per Inch	For material thickness	Packing	Item Number	Price
4-1/2" x 3/16" x 1/16"	3-3/4"	6	1/8" - 2-3/8"	5	670542	\$34.93

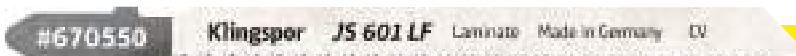

Jigsaw blade **670550**

JS 601 LF LAMINATE

Advantages: Very clean, straight and chip-free cuts on both sides in plastic and plastic-coated materials - Top seller for laminate and vinyl parquet flooring

Properties:	
Class	T-shaft
Design	Crossground, tapered
Material	Chromium-vanadium

Applications:	
Laminate	●
Plastic	●
Laminated panels	●
Floor layer	●
Woodworking craft	●

Width x Length x Thickness	Cutting Length	Teeth Per Inch	For material thickness	Packing	Item Number	Price
5/16" x 3-5/16" X 1/16"	2-15/16"	17	1/8" - 1-3/16"	5	670550	\$24.45

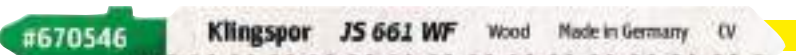

Jigsaw blade **670546**

JS 661 WF WOOD

Advantages: Very clean, straight cuts in wood and wood-based materials - Clean edges on the visible side due to butt serration - Especially for coated boards and kitchen worktops

Properties:	
Class	Supra

Applications:	
Softwood	●
Construction wood	●
Kitchen worktop	●
Plywood	●
Materials:	
Furniture industry	●
Kitchen cabinet makers	●
Multiplex boards	●

Width x Length x Thickness	Cutting Length	Teeth Per Inch	For material thickness	Packing	Item Number	Price
4" x 5/16" x 3/64"	3"	10	3/16" - 2"	5	670546	\$14.35



JIGSAW BLADES



Jigsaw blade **670547**

JS 302 WQ WOOD

Advantages: Very fast, rough cuts in almost all wood materials - Top seller with very good price-performance ratio.

Properties:	
Class	T-shaft
Design	Crossground, set
Material	Chromium-vanadium

Applications:	
Softwood	●
Construction wood	●
Kitchen worktop	●
Plywood	●
Chipboard	●
Blockboard	●
Multiplex boards	●
MDF	●

Width x Length x Thickness	Cutting Length	Teeth Per Inch	For material thickness	Packing	Item Number	Price
4" x 5/16" x 3/64"	3"	6	3/16" - 2"	5	670547	\$14.35



Jigsaw blade **670549**

JS 352 WQ WOOD

Advantages: Very fast, rough curved cuts in almost all wood materials - Top seller with very good price/performance ratio

Properties:	
Class	T-shaft
Design	Crossground, set
Material	Chromium-vanadium

Applications:	
Softwood	●
Construction wood	●
Kitchen worktop	●
Plywood	●
Chipboard	●
Blockboard	●
Multiplex boards	●

Width x Length x Thickness	Cutting Length	Teeth Per Inch	For material thickness	Packing	Item Number	Price
4" x 5/16" x 3/64"	3"	10	1/8" - 1-1/4"	5	670549	\$15.35



Jigsaw blade **670540**

JS 601 WF WOOD

Advantages: Very clean, straight cuts in wood and wood-based materials

Properties:	
Class	T-shaft
Design	Crossground, tapered
Material	Chromium-vanadium

Applications:	
Softwood	●
Construction wood	●
Plywood	●
Blockboards	●
Chipboard	●
Multiplex boards	●
MDF	●

Width x Length x Thickness	Cutting Length	Teeth Per Inch	For material thickness	Packing	Item Number	Price
4-1/2" x 5/16" x 3/64"	3-1/2"	10	3/8" - 2-1/2"	5	670540	\$17.44

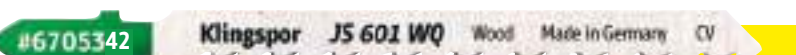

Jigsaw blade **670542**

JS 601 WQ WOOD

Advantages: Very clean, straight and fast cuts in wood and wood-based materials

Properties:	
Class	T-shaft
Design	Crossground, tapered
Material	Chromium-vanadium

Applications:	
Softwood	●
Construction wood	●
Kitchen worktop	●
Plywood	●
Chipboard	●
Blockboard	●
Multiplex boards	●
MDF	●

Width x Length x Thickness	Cutting Length	Teeth Per Inch	For material thickness	Packing	Item Number	Price
4-1/2" x 3/16" x 1/16"	3-3/4"	6	1/8" - 2-3/8"	5	670542	\$34.93

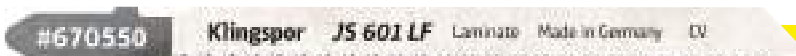

Jigsaw blade **670550**

JS 601 LF LAMINATE

Advantages: Very clean, straight and chip-free cuts on both sides in plastic and plastic-coated materials - Top seller for laminate and vinyl parquet flooring

Properties:	
Class	T-shaft
Design	Crossground, tapered
Material	Chromium-vanadium

Applications:	
Laminate	●
Plastic	●
Laminated panels	●
Floor layer	●
Woodworking craft	●

Width x Length x Thickness	Cutting Length	Teeth Per Inch	For material thickness	Packing	Item Number	Price
5/16" x 3-5/16" X 1/16"	2-15/16"	17	1/8" - 1-3/16"	5	670550	\$24.45



Jigsaw blade **670546**

JS 661 WF WOOD

Advantages: Very clean, straight cuts in wood and wood-based materials - Clean edges on the visible side due to butt serration - Especially for coated boards and kitchen worktops

Properties:	
Class	Supra

Applications:	
Softwood	●
Construction wood	●
Kitchen worktop	●
Plywood	●
Materials:	
Furniture industry	●
Kitchen cabinet makers	●
Multiplex boards	●

Width x Length x Thickness	Cutting Length	Teeth Per Inch	For material thickness	Packing	Item Number	Price
4" x 5/16" x 3/64"	3"	10	3/16" - 2"	5	670546	\$14.35



JIGSAW BLADES



Reciprocating saw blade **670464**

RS 603 WF SUPRA

Advantages: Very fast, rough cuts in almost all wood materials - Top seller with very good price-performance ratio.

Properties:	
Thread	Universal shaft 1/2"
Design	Crossground, set
Material	Chromium-vanadium

Applications:	
Softwood	●
Construction wood	●
Kitchen worktop	●
Plywood	●



Chipboard	●
Blockboard	●
Multiplex boards	●
MDF	●

Width x Length x Thickness	Cutting Length	Teeth Per Inch	For material thickness	Packing	Item Number	Price
3/4" x 9" x 3/64"	8-1/4"	6	1/4" - 7"	5	670464	\$43.99
3/4" x 12" x 3/64"	11"	6	1/4" - 10"	5	670476	\$56.21

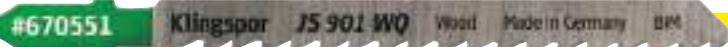

Jigsaw blade **670551**

JS 901 WQ WOOD

Advantages: Very fast, straight and clean cuts in hard materials such as hardwood, laminate and HPL boards - Particularly long service life due to bi-metal construction

Properties:	
Thread/Shaft	T-shaft
Design	Crossground/tapered
Material	Bi-Metal

Applications:	
Hardwood	●
HPL (High Pressure Laminate)	●
Plywood	●



Chipboard	●
Blockboard	●

Width x Length x Thickness	Cutting Length	Teeth Per Inch	For material thickness	Packing	Item Number	Price Each
4" x 5/16" x 3/64"	3"	6	3/16" - 2"	5	670551	\$14.35



Jigsaw blade **670541**

JS 931 WF WOOD

Advantages: Top product with double-sided serration for extreme curved cuts in wood and wood-based materials - Fine and clean cutting edges - Suitable for thin and thick material

Properties:	
Thread/Shaft	T-shaft
Design	Crossground/tapered
Material	Bi-Metal

Applications:	
Softwood	●
Construction wood	●
Kitchen worktop	●
Plywood	●



Chipboard	●
Blockboard	●
Multiplex boards	●
MDF	●

Width x Length x Thickness	Cutting Length	Teeth Per Inch	For material thickness	Packing	Item Number	Price Each
4" x 5/16" x 3/64"	3"	8-11	3/8" - 1-3/4"	5	670541	\$35.96



Jigsaw blade **670549**

JS 941 LF SPECIAL

Advantages: Top product with back serration for curved cuts in laminate, vinyl parquet, plastic and plastic-coated panels - Fine serration for clean and tear-free cutting edges on all sides

Properties:	
Thread/Shaft	T-shaft
Design	Crossground/tapered
Material	Chromium-vanadium

Applications:	
Laminate	●
Coated panels	●
Plastic	●

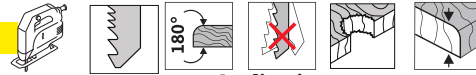

Width x Length x Thickness	Cutting Length	Teeth Per Inch	For material thickness	Packing	Item Number	Price Each
4" x 5/16" x 3/64"	3"	17-19	3/16" - 2"	5	670549	\$14.35

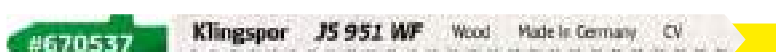

Jigsaw blade **670537**

JS 951 WF WOOD

Advantages: Fine and clean curved cuts in softwood and coated panels thanks to pointed toothing - Also perfectly suited for cutting laminate

Properties:	
Thread	T-shaft
Design	Crossground, tapered
Material	Chromium-vanadium

Materials:	
Kitchen worktop	●
Coated panels	●
Softwood	●
Construction wood	●

Applications:	
Furniture industry	●
Kitchen cabinet makers	●
Woodworking craft	●

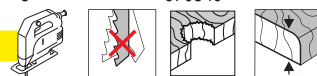

Width x Length x Thickness	Cutting Length	Teeth Per Inch	For material thickness	Packing	Item Number	Price Each
4" x 5/16" x 3/64"	3"	18	3/16" - 2"	5	670537	\$14.35



Jigsaw blade **670533**

JS 971 WF WOOD

Advantages: Fine and clean curved cuts in softwood and coated panels thanks to point toothing - Also perfectly suited for cutting laminate

Properties:	
Thread	T-shaft
Design	Crossground, tapered
Material	Chromium-vanadium

Applications:	
Softwood	●
Construction wood	●
Kitchen worktop	●
Plywood	●

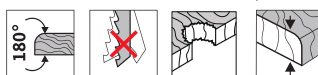

Chipboard	●
Blockboard	●
Multiplex boards	●
MDF	●

Width x Length x Thickness	Cutting Length	Teeth Per Inch	For material thickness	Packing	Item Number	Price Each
4" x 5/16" x 3/64"	3"	12	3/16" - 2"	5	670533	\$14.35

JIGSAW BLADES

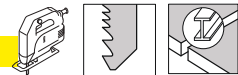

Jigsaw blade **670498**

JS 994 MT METAL

Advantages: Special blade with Vario tothing for steel and stainless steel sheet - Finer tothing (as JS994 MF) for thinner material thicknesses - Straight cut - Long service life due to bi-metal construction

Properties:

Thread	T-Shaft
Design	Milled, wavy set
Material	Bi-metal

Applications:

Sheet Metal	●
Metal	●
Steel	●
Stainless Steel	●

Width x Length x Thickness	Cutting Length	Teeth Per Inch	For material thickness	Packing	Item Number	Price Each
4" x 5/16" x 3/64"	3"	6	3/16" - 2"	5	670498	\$21.56

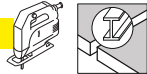

Jigsaw blade **669417**

JS 904 MF METAL

Advantages: Top seller for metalworking - Straight cuts in all types of sheet metal and metal of all kinds, also stainless steel - Long service life due to bi-metal construction

Properties:

Thread	T-Shaft
Design	Milled, wavy set
Material	Bi-metal

Applications:

Sheet Metal	●	Non-ferrous metals	●
Metal	●	Aluminum	●
Steel	●	Wood with nails	●
Stainless Steel	●		

Width x Length x Thickness	Cutting Length	Teeth Per Inch	For material thickness	Packing	Item Number	Price Each
4" x 5/16" x 3/64"	3"	6	3/16" - 2"	5	669417	\$22.59

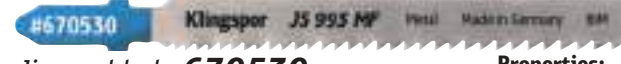

Jigsaw blade **670530**

JS 993 MF SPECIAL

Advantages: Special blade with progressive tothing for profiles and sheets made of stainless steel, steel and other metals - For thin and thick material (up to 10mm thickness) - Very fast and straight cut. Long service life due to bi-metal construction

Properties:

Thread	T-Shaft
Design	Milled, wavy set
Material	Bi-metal

Applications:

Sheet metal	●	Non-ferrous metals	●
Metal	●	Aluminum	●
Steel	●		
Stainless Steel	●		

Width x Length x Thickness	Cutting Length	Teeth Per Inch	For material thickness	Packing	Item Number	Price Each
5/16" x 5 1/4" x 3/64"	4 5/16"	10-14	1/8" - 3"	5	670530	\$23.62

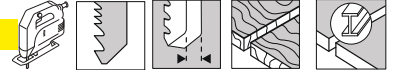

Jigsaw blade **670527**

JS 993 AX SPECIAL

Advantages: Universal saw blade with Vario tothing in bi-metal execution suitable for cutting all materials, also for wood with nails - Extra thick, stable and long blade for large workpiece cross-sections

Properties:

Thread	T-Shaft
Design	Milled, set
Material	Bi-metal

Applications:

Hardwood	●	Metal	●
Fibre reinforced plastics	●	Stainless Steel	●
Epoxy resin	●	Non-ferrous metals	●
Steel	●	Wood with nails	●

Width x Length x Thickness	Cutting Length	Teeth Per Inch	For material thickness	Packing	Item Number	Price Each
5/16" x 5 3/16" x 1/16"	4 5/16"	10-14	1/8" - 3"	5	670527	\$23.62

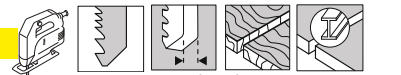

Jigsaw blade **670532**

JS 904 MT SPECIAL

Advantages: Universal saw blade with Vario tothing in bi-metal execution suitable for cutting all materials, also for wood with nails - Extra thick, stable and long blade for large workpiece cross-sections

Properties:

Thread	T-Shaft
Design	Milled, wavy set
Material	Bi-metal

Applications:

Metal	●
Sandwich material	●
Aluminum	●
Fibre reinforced plastics	●

Width x Length x Thickness	Cutting Length	Teeth Per Inch	For material thickness	Packing	Item Number	Price Each
5/16" x 5 3/16" x 1/16"	4 5/16"	10-14	1/8" - 3"	5	670532	\$39.05

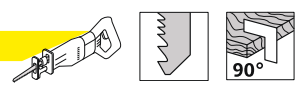
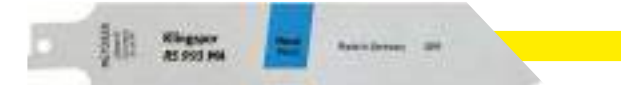

Reciprocating saw blade **670428**

RS 993 MA SPECIAL

Advantages: Bi-metal blade with Vario tothing for all types of metal, including stainless steel - Particularly suitable for medium to thick sheets and profiles - Broad blade for precise rectangular and straight cuts - Particularly suitable for use in the heating and plumbing sector

Properties:

Thread/Shaft	Universal shaft 1/2"
Design	Milled, set
Material	Bi-Metal

Applications:

Sheet Metal	●
Steel	●
Stainless Steel	●

Width x Length x Thickness	Cutting Length	Teeth Per Inch	For material thickness	Packing	Item Number	Price Each
1" x 6" x 1/32"	5 1/8"	10-14	1/64"-7/16"	5	670428	\$12.20
1" x 9" x 1/32"	8"	10-14	1/64"-7/16"	5	670338	\$13.95



JIGSAW BLADES



Reciprocating saw blade 670496 RS 603 WR SUPRA

Advantages: Cr-V saw blade with coarse tothing - For fast, rough cuts in wood, wood materials and kitchen worktops - Also suitable for green wood and firewood

Properties:	
Thread/Shaft	Universal shaft 1/2"
Design	Milled, set
Material	Chromium-vanadium

Materials:	
Softwood	●
Construction wood	●
Greenwood	●
Firewood	●

Applications:	
Demolition company	●
Fitters	●
Maintenance	●
Woodworking craft	●

Width x Length x Thickness	Cutting Length	Teeth Per Inch	For material thickness	Packing	Item Number	Price Each
3/4" x 6" x 3/64"	5-1/8"	4	9/16" - 2"	5	670496	\$35.56
3/4" x 9" x 3/64"	8-1/4"	3	3/4" - 6-11/16"	5	670479	\$43.99
3/4" x 12" x 3/64"	11"	3	3/4" / 10"	5	670472	\$56.21

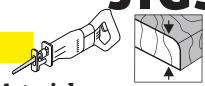

Reciprocating saw blade 670435 RS 953 AQ SPECIAL

Advantages: Universal bi-metal blade for wood, wood with metal (nails, screws, fittings) and plastics - Ideal for demolition work, renovation of old buildings - Fast cuts - Also suitable for rough curve cutting

Properties:	
Thread/Shaft	Universal shaft 1/2"
Design	Milled, set
Material	Bi-Metal

Materials:	
Wood with nails	●
Chipboard	●
Fibre reinforced plastics	●
Epoxy resin	●

Applications:	
Demolition company	●
Fitters	●
Locksmith's shop	●
Maintenance	●

Width x Length x Thickness	Cutting Length	Teeth Per Inch	For material thickness	Packing	Item Number	Price Each
3/4" x 6" x 3/64"	5-1/8"	6	1/4" - 4"	5	670435	\$68.25
3/4" x 9" x 3/64"	8-1/4"	6	1/4" - 6-5/8"	5	670421	\$92.33

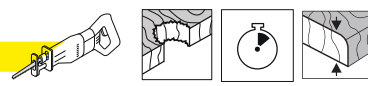

Reciprocating saw blade 670415 RS 903 MF SPECIAL

Advantages: Bi-metal blade for cutting steel, stainless steel, aluminium and non-ferrous metals - Particularly suitable for thin-walled sheet metal, profiles and pipes due to the fine tothing - Top seller for the heating and plumbing sector

Properties:	
Thread/Shaft	Universal shaft 1/2"
Design	Milled, set
Material	Bi-Metal

Materials:	
Steel	●
Stainless steel	●
NF metals	●
Aluminium	●

Applications:	
Fitters	●
Installers	●
Locksmith's shop	●
Maintenance	●

Width x Length x Thickness	Cutting Length	Teeth Per Inch	For material thickness	Packing	Item Number	Price Each
3/4" x 6" x 1/32"	5-1/8"	18	1/16" - 5/32"	5	670415	\$51.21
3/4" x 9" x 1/32"	8-1/4"	18	1/16" - 5/32"	5	670434	\$66.40

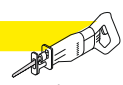

Reciprocating saw blade 670341 RS 993 AQ SPECIAL

Advantages: Saw blade in bi-metal construction and with Vario tothing - Universally suitable for metal, non-ferrous metals, wood and plastics - Fast cuts - Very well suited for wood with nails

Properties:	
Thread/Shaft	Universal shaft 1/2"
Design	Milled, set
Material	Bi-Metal

Materials:	
Fibre reinforced plastics	●
Sheet metal	●
Steel	●
Stainless steel	●
NF metals	●
Wood with nails	●

Applications:	
Demolition company	●
Fitters	●
Locksmith's shop	●
Maintenance	●

Width x Length x Thickness	Cutting Length	Teeth Per Inch	For material thickness	Packing	Item Number	Price Each
3/4" x 6" x 1/32"	5-1/8"	10-14	1/8" - 3/8"	5	670341	\$51.86
3/4" x 12" x 1/32"	11"	10-14	1/8" - 3/8"	5	670352	\$95.57

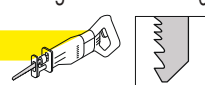

Reciprocating saw blade 670359 RS 993 PQ SPECIAL

Advantages: Saw blade in bi-metal construction and with Vario tothing - Universally suitable for metal, non-ferrous metals, wood and plastics - Fast cut - Top seller for pallets (wood with nails)

Properties:	
Thread/Shaft	Universal shaft 1/2"
Design	Milled, set
Material	Bi-Metal

Materials:	
Fibre reinforced plastics	●
Epoxy resin	●
Steel	●
Stainless steel	●
NF metals	●
Aluminium	●
Wood with nails	●

Applications:	
Pallet service	●

Width x Length x Thickness	Cutting Length	Teeth Per Inch	For material thickness	Packing	Item Number	Price Each
3/4" x 9" x 1/32"	8-1/4"	10-14	1/8" - 6-1/4"	5	670359	\$74.55

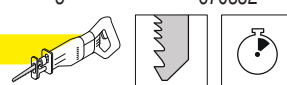

CARBIDE BURRS

Speed Guide

Carbide Burrs/
Power Wheels



The way to use the speed guide below:

1. Select application and material group
2. Identify the appropriate cut style.
3. Select burr diameter.
4. Follow maximum rotational speed.
5. Identify recommended cutting speed.

Part Number Example:

KCB - SF - 5 DC

Klingspor Carbide
Shape
Size
DC - Double Cut
SC - Single Cut

How to Select Your Burr 1.

Applications	Material	Cut
Efficient stock removal - deburring, finishing, cleaning.	Ferrous metals Non-ferrous metals	Double Cut - CUT 6 (D/C)
Heavy stock removal - deburring, milling, cleaning, machining	Non-ferrous metal: aluminium alloys Plastics	Non-ferrous - CUT 1 (NF)
Medium stock removal - deburring, milling, cleaning, finishing.	Non hardened steel <45HRc Hardened steel >45HRc: stainless steel High temperature-resistant metals: nickel, cobalt, titanium. Non-ferrous light metals: brass, copper, zinc. Hardened >45HRc: cast iron	Single Cut - CUT 3 (S/C)

MATERIAL GROUP 1		CUT STYLES 2								
Super Alloy Materials		Cut 3 / 6								
Hardened steel >45HRc			Cut 3							
Non hardened steel <45HRc				Cut 3 / 6						
High temperature-resistant materials		Cut 3 / 6								
Non-ferrous metals				Cut 1						
Non-ferrous light metals					Cut 1				Cut 6	
Plastics, Hard rubber								2. Cut 1		
BURR DIAMETER 4		MAXIMUM ROTATIONAL SPEED (RPM) 5								
Imperial (Inch)	Metric (mm)									
< 1/8	< 3	45,000	53,000	60,000	66,000	73,000	79,000	86,000	92,500	100,000
3/16	5	35,000	40,000	45,000	50,000	55,000	60,000	65,000	70,000	75,000
1/4	6	26,000	30,000	34,000	37,500	41,500	45,000	49,000	52,500	55,000
5/16	8	21,000	24,000	27,000	30,000	33,000	36,000	39,000	42,000	45,000
3/8	10	17,500	20,000	22,500	25,000	27,500	30,000	32,500	35,000	37,500
1/2	12	13,000	15,000	17,000	19,000	20,500	22,500	24,500	26,000	28,000
3. 5/8	15	10,500	12,000	13,500	15,000	16,500	18,000	19,500	21,000	22,500
3/4	20	9,000	10,000	11,000	12,500	14,000	15,000	16,250	17,500	19,000
1	25	6,500	7,500	8,500	9,500	10,500	11,000	12,000	13,000	14,000
		RECOMMENDED CUTTING SPEED 3								
METRIC (m/min)	5.	420	480	540	600	660	720	780	840	900
FRACTIONAL (SFM)		1400	1600	1800	2000	2200	2400	2600	2800	3000

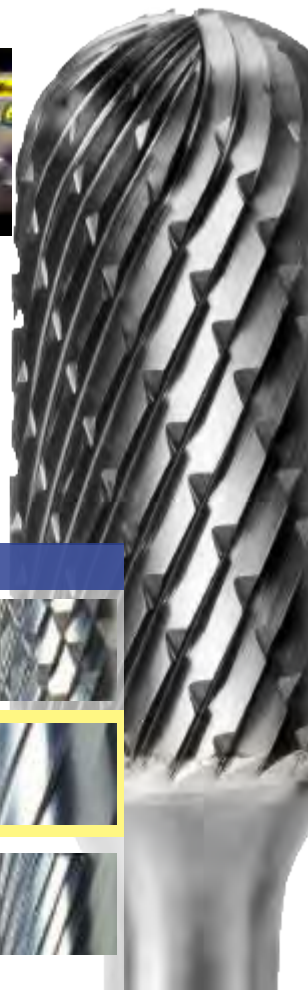

CARBIDE BURRS

Universal SA - Cylindrical No End Cut

Item#	Cutter Diameter D1	Length of Cut L2	Shank Diameter D2	Overall Length L1	Double Cut	Single Cut 3	Nonferrous Cut	Max RPMS	Price
KCB-SA-43L2 (SC)	1/8	9/16	1/8	2	●	●	–	100,000	\$17.06
KCB-SA-43L2 (DC)	1/8	9/16	1/8	2	●	●	–	100,000	\$17.57
KCB-SA-1 (SC)	1/4	5/8	1/4	2	●	●	–	55,000	\$21.70
KCB-SA-1 (DC)	1/4	5/8	1/4	2	●	●	–	55,000	\$21.70
KCB-SA-3 (SC)	3/8	3/4	1/4	2-1/2	●	●	–	37,500	\$30.50
KCB-SA-3 (DC)	3/8	3/4	1/4	2-1/2	●	●	–	37,500	\$30.50
KCB-SA-3L6 (SC)	3/8	3/4	1/4	6-3/4	●	●	–	37,500	\$42.65
KCB-SA-3L6 (DC)	3/8	3/4	1/4	6-3/4	●	●	–	37,500	\$42.65
KCB-SA-3NF	3/8	3/4	1/4	2-1/2	–	–	●	37,500	\$44.07
KCB-SA-4 (SC)	7/16	1	1/4	2-3/4	●	●	–	28,000	\$42.83
KCB-SA-4 (DC)	7/16	1	1/4	2-3/4	●	●	–	28,000	\$43.04
KCB-SA-5 (SC)	1/2	1	1/4	2-3/4	●	●	–	28,000	\$47.53
KCB-SA-5 (DC)	1/2	1	1/4	2-3/4	●	●	–	28,000	\$47.53

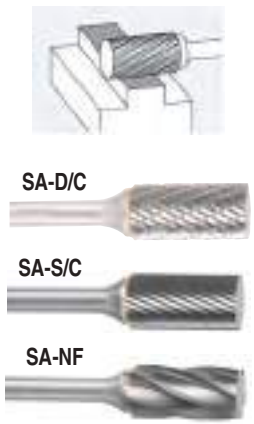
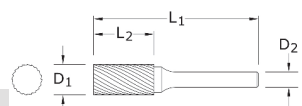

Universal SB - Cylindrical End Cut

Item#	Cutter Diameter D1	Length of Cut L2	Shank Diameter D2	Overall Length L1	Double Cut	Single Cut 3	Nonferrous Cut	Max RPMS	Price
KCB-SB-1 (SC)	1/4	5/8	1/4	2	●	●	–	55,000	\$25.17
KCB-SB-1 (DC)	1/4	5/8	1/4	2	●	●	–	55,000	\$23.48
KCB-SB-1L (SC)	1/4	1	1/4	2	●	●	–	55,000	\$34.75
KCB-SB-1L (DC)	1/4	1	1/4	2	●	●	–	55,000	\$34.75
KCB-SB-3 (SC)	3/8	3/4	1/4	2-1/2	●	●	–	37,500	\$33.48
KCB-SB-3 (DC)	3/8	3/4	1/4	2-1/2	●	●	–	37,500	\$33.48
KCB-SB-3L (SC)	3/8	1	1/4	2-3/4	●	●	–	37,500	\$39.87
KCB-SB-3L (DC)	3/8	1	1/4	2-3/4	●	●	–	37,500	\$39.87
KCB-SB-5 (SC)	1/2	1	1/4	2-3/4	●	●	–	28,000	\$52.25
KCB-SB-5 (DC)	1/2	1	1/4	2-3/4	●	●	–	28,000	\$52.25

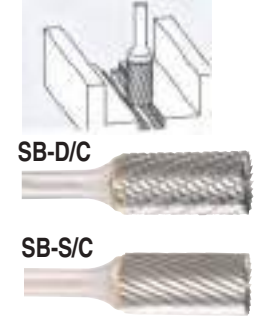
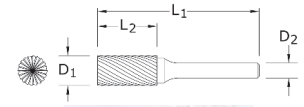

Universal SC - Cylindrical

Item#	Cutter Diameter D1	Length of Cut L2	Shank Diameter D2	Overall Length L1	Double Cut	Single Cut 3	Nonferrous Cut	Max RPMS	Price
KCB-SC-41 (SC/DC)	3/32	7/16	1/8	1-1/2	●	●	–	100,000	\$11.96
KCB-SC-42 (SC/DC)	1/8	9/16	1/8	1-1/2	●	●	–	100,000	\$12.74
KCB-SC-1 (SC/DC)	1/4	5/8	1/4	2	●	●	–	55,000	\$25.20
KCB-SC-1L (SC)	1/4	1	1/4	2	●	●	–	55,000	\$32.29
KCB-SC-1L (DC)	1/4	1	1/4	2	●	●	–	55,000	\$34.39
KCB-SC-1NF	1/4	3/4	1/4	2	–	–	●	55,000	\$32.97
KCB-SC-2(SC/DC)	5/16	3/4	1/4	2-1/2	●	●	–	45,000	\$30.86
KCB-SC-3(SC/DC)	3/8	3/4	1/4	2-1/2	●	●	–	37,500	\$41.11
KCB-SC-3L(SC/DC)	3/8	1	1/4	2-3/4	●	●	–	37,500	\$39.94
KCB-SC-3NF	3/8	3/4	1/4	2-1/2	–	–	●	37,500	\$44.07
KCB-SC-5(SC/DC)	1/2	1	1/4	2-3/4	●	●	●	28,000	\$53.34
KCB-SC-5NF	1/2	1	1/4	2-3/4	–	–	●	28,000	\$64.56
* KCB-SC-7(SC)	3/4	1	1/4	2-3/4	●	●	–	19,000	\$93.56
* KCB-SC-7(DC)	3/4	1	1/4	2-3/4	●	●	–	19,000	\$96.27

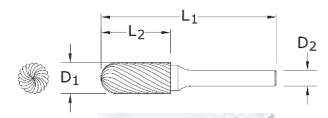

*3/8" shanks optional

CARBIDE BURRS

Universal SD - Cylindrical

Item#	Cutter Diameter D1	Length of Cut L2	Shank Diameter D2	Overall Length L1	Double Cut	Single Cut 3	Nonferrous Cut	Max RPMS	Price
KCB-SD-41(SC/DC)	3/32"	3/32"	1/8"	1-1/2"	●	●	—	100,000	\$12.74
KCB-SD-42(SC)	1/8"	1/8"	1/8"	1-1/2"	●	●	—	100,000	\$12.74
KCB-SD-42(DC)	1/8"	1/8"	1/8"	1-1/2"	●	●	—	100,000	\$12.72
KCB-SD-52(SC/DC)	5/32"	5/32"	1/8"	1-1/2"	●	●	—	75,000	\$29.73
KCB-SD-52(SC/DC)	5/32"	5/32"	1/8"	1-1/2"	●	●	—	75,000	\$30.50
KCB-SD-1(SC/DC)	1/4"	7/32"	1/4"	2"	●	●	—	55,000	\$23.21
KCB-SD-5(SC/DC)	1/2"	7/16"	1/4"	2-1/8"	●	●	—	28,000	\$37.53

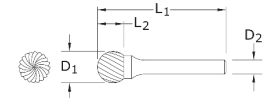

SD-D/C SD-S/C SD-NF

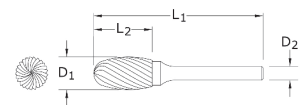

Universal SE - Oval

Item#	Cutter Diameter D1	Length of Cut L2	Shank Diameter D2	Overall Length L1	Double Cut	Single Cut 3	Nonferrous Cut	Max RPMS	Price
KCB-SE-3(SC/DC)	3/8"	5/8"	1/4"	2-3/8"	●	●	—	37,500	\$33.90
KCB-SE-3L6 (SC)	3/8"	5/8"	1/4"	6-5/8"	●	●	—	37,500	\$47.48
KCB-SE-3L6 (DC)	3/8"	5/8"	1/4"	6-5/8"	●	●	—	37,500	\$46.14
KCB-SE-5(SC/DC)	1/2"	7/8"	1/4"	2-5/8"	●	●	—	28,000	\$49.69

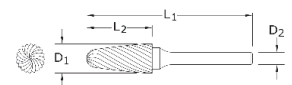

Universal SF - Tree Shape

Item#	Cutter Diameter D1	Length of Cut L2	Shank Diameter D2	Overall Length L1	Double Cut	Single Cut 3	Nonferrous Cut	Max RPMS	Price
KCB-SF-1(SC/DC)	1/4"	5/8"	1/4"	2"	●	●	—	55,000	\$26.31
KCB-SF-3(SC/DC)	3/8"	3/4"	1/4"	2-1/2"	●	●	—	37,500	\$33.16
KCB-SF-3NF	3/8"	3/4"	1/4"	2-1/2"	—	—	●	37,500	\$46.70
KCB-SF-13(SC/DC)	1/2"	3/4"	1/4"	2-1/2"	●	●	—	28,000	\$49.11
KCB-SF-5(SC/DC)	1/2"	1"	1/4"	2-3/4"	●	●	—	28,000	\$68.54
KCB-SF-5L6(SC/DC)	1/2"	1"	1/4"	7"	●	●	—	28,000	\$68.54
KCB-SF-5NF	1/2"	1"	1/4"	2-3/4"	—	—	●	28,000	\$68.54



Universal SG - Tree Shape Pointed End

Item#	Cutter Diameter D1	Length of Cut L2	Shank Diameter D2	Overall Length L1	Double Cut	Single Cut 3	Nonferrous Cut	Max RPMS	Price
KCB-SG-41(SC/DC)	1/8"	1/4"	1/8"	1-1/2"	3	3	—	100,000	\$12.74
KCB-SG-1(SC/DC)	1/4"	5/8"	1/4"	2"	3	3	—	55,000	\$25.57
KCB-SG-3(SC/DC)	3/8"	3/4"	1/4"	2-1/2"	3	3	—	37,500	\$26.31
KCB-SG-5(SC/DC)	1/2"	1"	1/4"	2-3/4"	3	3	—	28,000	\$48.17

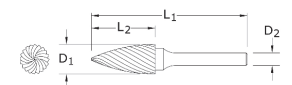

CARBIDE BURRS

Universal SH - Flame Shape

Item#	Cutter Diameter D1	Length of Cut L2	Shank Diameter D2	Overall Length L1	Double Cut	Single Cut 3	Nonferrous Cut	Max RPMS	Price
KCB-SH-5(SC/DC)	1/2"	1-1/4"	1/4"	3"	●	●	-	28,000	\$71.07

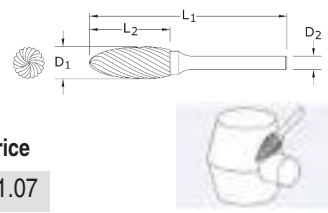

Universal SL - Radius End Taper Shape

Item#	Cutter Diameter D1	Length of Cut L2	Shank Diameter D2	Overall Length L1	Included Angle A	Double Cut	Single Cut 3	Nonferrous Cut	Max RPMS	Price
KCB-SL-1(SC/DC)	1/4"	5/8"	1/4"	2"	14°	●	●	-	55,000	\$26.94
KCB-SL-3(SC/DC)	3/8"	1-1/16"	1/4"	2-15/16"	14°	●	●	-	37,500	\$42.35
KCB-SL-3NF	3/8"	1-1/16"	1/4"	2-15/16"	14°	-	-	●	37,500	\$59.81
KCB-SL-4(SC/DC)	1/2"	1-1/8"	1/4"	3"	14°	●	●	-	28,000	\$51.79

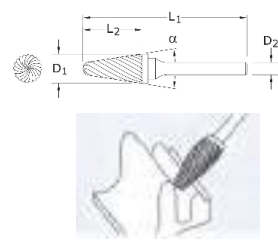

Universal SM - Cone Shape

Item#	Cutter Diameter D1	Length of Cut L2	Shank Diameter D2	Overall Length L1	Included Angle A	Double Cut	Single Cut 3	Max RPMS	Price
KCB-SM-5(SC/DC)	1/2"	7/8"	1/4"	2-3/4"	28°	●	●	28,000	\$53.19
* KCB-SM-6(SC/DC)	5/8"	1"	1/4"	2-8/9"	31°	●	●	22,500	\$71.07

*3/8" shanks optional

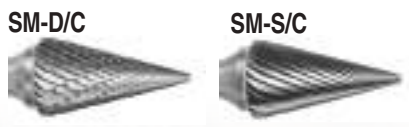
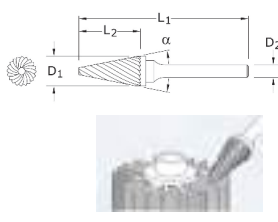

Universal SN - Cone Shape Inverted

Item#	Cutter Diameter D1	Length of Cut L2	Shank Diameter D2	Overall Length L1	Included Angle A	Double Cut	Single Cut 3	Max RPMS	Price
KCB-SN-41(SC/DC)	3/32"	1/8"	1/8"	1-1/2"	10°	●	●	100,000	\$12.74
KCB-SN-53(SC/DC)	3/16"	1/4"	1/8"	1-1/2"	10°	●	●	75,000	\$30.50

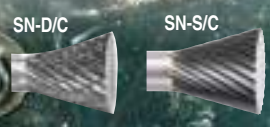
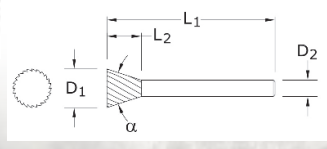

WATCH
CARBIDE BURRS
 IN ACTION

Don't Forget KLINGSPOR's Random Orbit Sander and KLINGSPOR Backing Pads

SPARTAN

and KLINGSPOR Backing Pads



Spartan



Spartan PSA



5" Sander Non-Vac
Hook & Loop
#SOS5H
\$153.51

5" Sander
Non-Vac PSA
#SOS5P
\$153.51

5" Sander Vacuum
Hook & Loop
#SOS5VH
\$207.83

6" Sander Non-Vac
Hook & Loop
#SOS6H
\$172.70

6" Sander
Non-Vac
PSA
#SOS6P
\$172.70

6" Sander Vacuum
Hook & Loop
#SOS6VH
\$226.16



5" Kling-On
No Hole
SBP5K
\$24.97

5" PSA
No Hole
SBP5P
\$24.97

5" Kling-On
Multi-Hole
SBP5KMP
\$33.33

6" PSA
No Holes
SBP6P
\$28.26

6" Kling-On
No Holes
SBP6K
\$28.26

6" Kling-On
Multi-Hole
SBP6KMP
\$47.48



POWER TOOLS

EXTREME R/O SANDER



FEATURES:

- Most consistent speed under load
- All new .3 HP motor design
- Best-in-class dust collection
- Tactile, ergonomic grip
- 12,000 OPM

KLINGSPOR PRODUCTS:

- Kling-On® (Hook & Loop) Paper Discs
- 710 XF Kling-On® Cloth Discs

NON-VACUUM * Non - Vacuum to Vacuum Conversion Kits available.

Dia	Orbit	Item #	Price
5"	3/16	DYNA00X51HK	\$251.00
	3/32	DYNA00X52K	\$251.00
		DYNA00X52HK	\$251.00
6"	3/16	DYNA00X61HK	\$251.00
	3/32	DYNA00X62HK	\$251.00

Dia	Orbit	Item #	Price
5"	3/16	DYNA00X51VK	\$261.00
	3/32	DYNA00X52VK	\$261.00
6"	3/16	DYNA00X61VK	\$261.00
	3/32	DYNA00X62VK	\$261.00

SANDER MAINTENANCE

Don't Forget the Air Lube

- DYNABRADE AIR LUBE**
 4 ounces - DYNA95821 \$17.15
 1 pint - DYNA95842 \$24.56
 1 gallon - DYNA95843 \$104.07
 • Only use 10 weight non detergent air lube



DYNABRADE MUFFLER INSERT PER EACH -
 DYNA56027 \$1.93



DYNABRADE MUFFLER INSERT 30 PACK -
 DYNA56054 \$16.80

RANDOM ORBITAL REFERENCE



Most Aggressive
3/8"



General Sanding
3/16"



Ultra Fine Sanding
3/32"

DYNORBITAL SPIRIT



FEATURES:

- Comfort handle
- Lower profile for improved control
- 14 SCFM @ 90psi
- High-wear, plastic valve stem
- Non-Vacuum to Vacuum Conversion Kits available
- Only 1.4 lbs.!
- 12,000 OPM

KLINGSPOR PRODUCTS:

- Kling-On® (Hook & Loop) Paper Discs
- 710 XF Kling-On® Cloth Discs

NON-VACUUM * Non - Vacuum to Vacuum Conversion Kits available.

Dia	Orbit	Item #	Price
5"	3/16	59020(H)	\$239.00
	3/32	59035(H)	\$239.00
6"	3/8	59010(H)	\$239.00
	3/16	59025(H)	\$239.00
	3/32	59040(H)	\$239.00

DYNABUG II ORBITAL SANDER



HOOK & LOOP - DYNA58500H
PSA - DYNA58509

FEATURES:

- New comfort handle
- Strong .15 HP motor & 10,000 RPM's
- Excellent for use in tight corners
- Precise 3/32 2 (mm) orbital motion
- 13 SCFM @ 90 PSI
- Lightweight at only 1.6 LBS it's ideal for vertical applications to help minimize fatigue

KLINGSPOR PRODUCTS:

- 3" x 4-3/8" KLING ON Sheets PS 33 only
- 3" x 4-3/8" PSA Sheets PS 33 only
- Other Materials available in PSA and KLING ON Rolls
- Replacement Pad - Hook & Loop #DYNA56315 Vinyl (PSA) #DYNA56355

Item #	Price
58500	\$279.89

MINI RAPTOR 2 PORTABLE VACUUM SYSTEM DYNA10051

- Compact shop friendly system easy to maneuver. Features large rigid rear wheels and front locking swivel casters.
- Auto filter clean W/ Wet/Dry
- Supports electric & pneumatic power tools.
- HEPA Filter replacement option available.
- Auto on/off W/ 10 Gallon Capacity.
- Adjustable Mar-free over-hose adapts to operator's needs.
- Flexible cut to fit airline/reusable fittings.
- Operating hose diameter settings.
- M-Class flow indicator light.
- Air Flow 161 CFM (76 l/s).
- 100" static water lift.
- Foldable Trolley Handle.

MINI RAPTOR 2 M-CLASS VACUUM w/ 3" CENT VAC MINI EXTREME 3/16 Orbit MRAPVACX31V.....\$1,839.00

MINI RAPTOR 2 M-CLASS VACUUM w/3" CENT VAC MINI EXTREME 3/32 Orbit MRAPVACX32V.....\$1,839.00

MINI RAPTOR 2 M-CLASS VACUUM w/5" EXTREME CEN/VAC 3/16" ORBIT W/SPEED REGULATOR MRAPVACX51VHS.....\$1,857.00

MINI RAPTOR 2 M-CLASS VACUUM w/5" EXTREME CEN/VAC 3/16" ORBIT MRAPVACX51VK.....\$1,833.00

MINI RAPTOR 2 M-CLASS VACUUM w/ 5" EXTREME CEN/VAC 3/32" ORBIT MRAPVACX52VK.....\$1,833.00



MINI RAPTOR 2 M-CLASS VACUUM w/6" EXTREME C/V H/F 3/16" ORBIT MRAPVACX61VK.....\$1,833.00

MINI RAPTOR 2 M-CLASS VACUUM w/6" EXTREME CEN/VAC 3/32" ORBIT MRAPVACX62VK.....\$1,833.00

POWER TOOLS

NITRO SERIES ELECTRIC DYNISHER

FEATURES:

- Achieve superior in-line finishes on metal.
- 800 - 3,000 RPM, adjustable in 500 RPM increments.
- Variable speed dial allows operator to pre-select speed to suit each application.
- Includes 13378 Arbor for use with 3/4" bore accessories.
- Multi-purpose arbor accepts Dynacushion® pneumatic wheels (5" dia x 3-1/2" wide).
- Non-woven nylon wheels can also be used utilizing 3/4" arbor.
- Features a locking trigger for extended use.
- Adjustable handle and guard.
- Comfortable ergonomic design for smooth, repeatable results.



MODEL# DYNA00DYS1

DRUM NOT INCLUDED



Dimensions Dia. x w	Part No.	Hub Composition	Arbor Hole	Wheel Part No.	Wheel Type	Belt Size W x L	Max RPM
5" x 2-3/4" (127 mm x 70 mm)	92935	Aluminum	Universal 1/2" 5/8" or 3/4" Bore	94482	Standard	2-3/4" x 15-1/2" (70 mm x 394 mm)	3,500
	92936	Composite					
5" x 3-1/2" (127 mm x 89 mm)	92937	Aluminum	Universal 1/2" 5/8" or 3/4" Bore	94481	Standard	3-1/2" x 15-1/2" (89 mm x 394 mm)	3,500
	92938	Composite					

DYNASTRAIGHT®

FEATURES:

- 3,400 rpm
- Ideal set-up for Dynacushion® Wheel
- 5/8"-11 threaded arbor for use with pneumatic wheels
- Available combo arbor for wheels up to 3" wide and 5/8" or 1" dia. center hole
- Great for stainless steel work

KLINGSPOR PRODUCTS:

- 3 1/2" wide Non-Woven Belts
- SM611 Abrasive Flapwheels (up to 3,800 rpm) or 10" dia.
- VKM 630 Small Finishing Flapwheels
- 8" Sanding Stars
- Flutter Sheets
- 4" and 6" diameter Power Wheels



DRUM NOT INCLUDED

DYNA13204

ALSO AVAILABLE:

Model 13205

13071 Combo Arbor for up to 3" wide wheels which have either 5/8" or 1" diameter center hole. Any Dynacushion® pneumatic wheel with 5/8" bore may also be mounted.



DYNASTRAIGHT KITS

13204K

.7 hp Dynastraight® Finishing Tool Kit Includes:
(1) 13505 Tool, (1) 92801 Dynacushion® Wheel, (1) 94465 Wheel Inflation Tool



13204K



13505K



13521K

13505K

1 hp Dynastraight® Finishing Tool Kit Includes:
(1) 13505 Tool, (1) 92801 Dynacushion® Wheel, (1) 94465 Wheel Inflation Tool

13521K

1 hp Dynastraight® Finishing Tool Kit Includes:
(1) 13505 Tool, (1) 92937 Dynacushion® Wheel, (1) 94465 Wheel Inflation Tool

Model No.	Belt Length	Belt Width	Head Style	Speed	Power	Hose Dia.	Plug Thread Size	Plug	Coupler	Weight
13204k				3,400 RPM	.7hp					7.5 lbs.
1350K	15-1/2"	3-1/2"	Straight	3,400 RPM	1 hp	3/8"	95,675	95,675	95,674	7.3 lbs.
13521K				1,800 RPM	1 hp					7.2 lbs.

DYNISHER KITS

13400K

.7 hp Dynisher Finishing Tool Kit Includes:
(1) 13400 Tool, (1) 92937 Dynacushion® Wheel, (1) 94465 Wheel Inflation Tool

13450K

1 hp Dynisher Finishing Tool Kit Includes:
(1) 13450 Tool, (1) 92801 Dynacushion® Wheel, (1) 94465 Wheel Inflation Tool

DYS1K

Electric Dynisher Finishing Tool Kit Includes:
(1) DYS1 Tool, (1) 92938 Dynacushion® Wheel, (1) 98130 Air Chuck



13400K



13450K



DYS1K

Model No.	Belt Length	Belt Width	Head Style	Speed	Power	Hose Dia.	Plug Thread Size	Plug	Coupler	Weight
13400k			7"	3,400 RPM	.7 hp					7.5 lbs.
13450K	15-1/2"	3-1/2"	Right Angle	2,800 RPM	1 hp	3/8"	1/4" NPT	95,675	95,674	7.3 lbs.
DYS1K			Right Angle	800-3,000 RPM	120v. 9 Amp					7.2 lbs.



Works best when routinely lubricated (Item# 95542)



SANDING STARS NOT INCLUDED

LIGHTWEIGHT DYNINGER - DYNA52050

FEATURES:

- For use with Spindle Mounted Sanding Stars
- 3,200 rpm variable speed
- Air-Flow Control Dynaswivel®
- Rear exhaust
- Replaces tedious hand sanding

KLINGSPOR PRODUCTS:

- 4" Sanding Stars
- Flutter Sheets (with Flutter Sheet Arbor)
- 4" and 6" Power Wheels
- Use with #Dyna95542 Gear Grease and Grease Gun #DYNA95541



ALSO AVAILABLE:

Dyna52052 Dyninger with 1/2" Arbor
Dyna52051 Dyninger with 6mm Collet

DIE GRINDERS



DYNA50219 - .3 HP KIT

FEATURES:

Nitro Tool .3 hp Die Grinder Kit Contains
DGR31 - .3 hp Right Angle Die Grinder (18K RPM)
DGS31 - .3 hp Straight Die Grinder (25K RPM)

DYNA50218 - .5 HP KIT

FEATURES:

Nitro Tool .5 hp Die Grinder Kit Contains
DGR51 - .5 hp Right Angle Die Grinder (14K RPM)
DGS51 - .5 hp Straight Die Grinder (20K RPM)

RAISED PANEL SANDER - DYNA57906

Air Powered Finishing Sander. Includes 57956 Raised Panel Pad (4" long x 3/4" wide) with unique angled edges for sanding in tight corners and on raised panel edges.



58021 3/8" (10 MM) DIAMETER NON-VACUUM DYNAFINE BACKSPASH RADIUS DISC PAD, VINYL-FACE

58024 3/4" (19 MM) DIAMETER NON-VACUUM DYNAFINE BACKSPASH REVERSE RADIUS DISC PAD, VINYL-FACE



DYNADGR31 - .3 HP

FEATURES:

- .3 hp / 16,000 RPM
- 1/4" collet / rear exhaust
- Gearless, smooth running air motor

KLINGSPOR PRODUCTS:

- 1" - 4" QDC's, QRC's, & QMC's
- Mini Flap Discs
- Unitized wheels
- Wire brushes with 1/4" shank

DYNADGR51 - .5 HP

FEATURES:

- .5 hp / 14,000 RPM
- 1/4" collet / rear exhaust
- Gearless, smooth running air motor

KLINGSPOR PRODUCTS:

- 1" - 4" QDC's, QRC's, & QMC's
- Mini Flap Discs
- Unitized wheels
- Wire brushes with 1/4" shank

POWER TOOLS

DYNAFILE DETAIL SANDER DYNA57900

Air Powered Finishing Sander. Excellent for use in tight corners. Sander comes with one triangle and one tear-drop hook-face pad.



FEATURES:

- Excellent for use in tight corners
- Eliminates finger sanding
- 13,000 RPM motor with 1/32 orbital action
- 20 SCFM @ 90 PSI
- Handle has 7 degree offset for greater comfort
- Lightweight only 1.6 LBS

KLINGSPOR PRODUCTS:

- Triangular PSA & KLING-ON Discs
- Triangular Non-Woven Discs
- Tear-Drop PSA and KLING-ON Discs
- Tear-Drop Non-Woven Discs



DYNADGS31 - .3 HP

FEATURES:

- .3 hp / 25,000 RPM
- 1/4" collet / rear exhaust
- Gearless, smooth running air motor

KLINGSPOR PRODUCTS:

- KM 613's with 1/4" shank
- Cartridge rolls
- No lap bands
- Carbide Burrs & Mounted Points
- Spindle Brushes
- Unitized wheels
- Wire brushes with 1/4" shank

DYNADGS51 - .5 HP

FEATURES:

- .5 hp / 20,000 RPM
- 1/4" collet / rear exhaust
- Gearless, smooth running air motor

KLINGSPOR PRODUCTS:

- KM 613's with 1/4" shank
- Cartridge rolls
- No lap bands
- Carbide Burrs & Mounted Points
- Spindle Brushes
- Unitized wheels
- Wire brushes with 1/4" shank

POWER TOOLS

DYNAFILE® I

DYNA14000



FEATURES:

- Runs 24" long belts
- Allows for best tracking - belt wont pop off easily with pressure
- Grinds smooth without gouging
- Ideal for stainless steel weld grinding

ELECTRIC DYNAFILE® II

DYNA40610



FEATURES:

- Runs 1/8" - 3/4" wide by 18" belts
- Over 20 different contact arms
- 120V and 220V options available

DYNAFILE® II

Air Powered Abrasive Belt Tool Reach normally inaccessible areas.



DYNA40320

FEATURES:

- Grind, deburr, blend and polish. Work on metal, plastic, fiberglass, composites, rubber, glass and stone
- Lightweight, ergonomic 7° offset design
- Grinding head pivots 360°
- Grind off contact wheel or platen pad
- Finish & polish using slack of belt
- Secure belt housing at desired position using 95134 Hex Key

KLINGSPOR PRODUCTS:

- Includes 11206 Contact Arm for 3/4" wide x 18" long abrasive belts

MINI-DYNAFILE® II

Air Powered Abrasive Belt Tool. Ideal for strap polishing and working in narrow openings.



FEATURES:

- For broad range of applications
- Lightweight ergonomic design handle features 7° offset. Multi-position grinding head pivots 180°
- Pop-off belt guard for easy abrasive change; easy belt tracking adjustment knob

KLINGSPOR PRODUCTS:

- 1/8", 1/4" and 1/2" wide x 12" coated long belts
- 1/8", 1/4" and 1/2" wide x 12" non-woven long belts

APPROVED FILE BELT MATERIALS:

CS 308: Our YX weight Aluminum Oxide material is a fully resin-bonded product that offers the benefits of a polyester backing in an X-weight. Use on ferrous or non-ferrous metals and on hardwoods. CS 308 has an extended grit range that allows for coarse to ultra-fine belt sanding and polishing.

CS 310: Aluminum Oxide, X or X-Flex cloth resin-resin bond, closed coat. Suitable for all ferrous metals, hardwoods, leather, aluminum, stainless steel, and most alloys.

CS 710: Heat-treated Aluminum Oxide, X-Flex cloth resin-resin bond, closed coat. Suitable for polishing all ferrous metals and sanding on hardwoods.

CS 409: Alumina Zirconia grain with a multi-bond additive on polyester backing for grinding high alloys such as titanium and metals like stainless steel where heat build-up is a problem.



CS 411 Y: Alumina Zirconia resin-bonded, polyester cloth Y-weight (Y) backing for high pressure, heavy stock removal on all types of metal, especially carbon and tool steels. Polyester backings can be used wet or dry.

CS 416: 100% Alumina Zirconia semi-open coat on a heavy or extra heavy polyester backing for high pressure production situations grinding steel, stainless steel, non-ferrous metals, plastic, leather and wood planing.

CS 631 XF: Ceramic Aluminum Oxide on either X-flex backing or very flexible J-flex backing. Perfect for use on steels of all types but specifically for hard steels and under high grinding pressure. Added multibond lubricant enhances grinding properties and reduces heat build-up.

CS 920 ACT: Ceramic Aluminum Oxide with multibond lubricant added to enhance the grinding properties and cool the grinding surface. Features a heavy polyester backing that enhances its durability while removing large amounts of stock.

CS 922 ACT: Ceramic Aluminum Oxide on our heaviest YY polyester backing for use on steels of all types and under high grinding pressure applications.

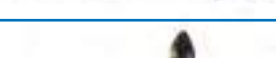
Part Number	Comments	Belt Size (W x L)	Contact Wheel Assembly (includes bearing and shaft)	Plated Pad
11203	Order 11312 for heavy-duty version. 	1/2" x 18"	11078 5/8" dia. x 3/8" wide, rubber	11025 1/2" wide; Soft
	• Standard on Models 40335, 40610 and 40615 • Grind over contact wheel or platen			
		1/2" x 18" or 1/2" x 18"	11204: 11080 Wheel 1" dia. x 3/8" wide, 70 duro 11305: 11093 Wheel, 1" dia. x 3/8" wide, 40 duro (Both wheels radiused rubber)	None
	• Unique offset design • Strap polishing is easy with this arm			
		1/2" x 18" or 1/4" x 18"	11086 1" dia. x 3/8" wide, urethane, tapered	None
	• Grind corners, enter grooves, strap polish • "V" shape wheel			

4-1/2" RIGHT ANGLE AIR GRINDER

MODEL 52632 \$937.00



1.3 hp, 12,000 RPM,
Side Exhaust, 5/8"-11 Spindle Thread

FEATURES:

- Depressed Center Wheel Grinder is ideal for fast weld and stock removal, heavy deburring, rust and scale removal
- Includes 25212 Wheel Guard, 25262 Backup Flange and 53696 Locking Flange
- Vibration Dampening Side Handle included
- Rotational Exhaust system allows operator to rotate a full 360 degrees to ensure that exhaust is directed away from operator
- BPS900001 Adjustable spanner wrench

KLINGSPOR PRODUCTS:

- Any 4-1/2" sizes of the following:
- CMT Flapdisc
 - SMT Flapdisc
 - NCD Power wheel
 - Cut off wheel
 - Grinding Discs
 - WSM 617 Flap Wheel
 - Unitized Discs



Nitro Series Electric Dynisher

POWER TOOLS

FEATURES:

- Achieve superior in-line finishes on metal.
- 800 - 3,000 RPM, adjustable in 500 RPM increments.
- Variable speed dial allows operator to pre-select speed to suit each application.
- Includes 13378 Arbor for use with 3/4" bore accessories.
- Multi-purpose arbor accepts Dynacushion® pneumatic wheels (5" dia x 3-1/2" wide).
- Non-woven nylon wheels can also be used utilizing 3/4" arbor.
- Features a locking trigger for extended use.
- Adjustable handle and guard.
- Comfortable ergonomic design for smooth, repeatable results.



DRUM NOT INCLUDED

Dynacushion Pneumatic Wheels

	Dimensions Dia. x W	Part No.	Hub Composition	Arbor Hole	Wheel Part No.	Wheel Type	Belt Size W x L	Max. RPM	Recommended Dynabrade Tools	
	2-1/4" x 3"	92858	Aluminum	1/2"-13 Thread	94433	Standard	3" x 7-3/8"	9,000	Not applicable	
		94432		5/8"-11 Thread					13204, 13505, 13509, 13515, 13519, 13520	
	3" x 2-1/4"	92846	Aluminum	1/2"-13 Thread	92643	Standard	2-1/4" x 9-3/4"	7,000	Not applicable	
		92847		5/8"-11 Thread					13204/205/209, 13515/519/520	
		92848		1/2"-13 Thread	92644	Heavy Duty			Not applicable	
		92849		5/8"-11 Thread					13204/205/209, 13515/519/520	
	3-1/4" x 3"	92824	Aluminum	1/2"-13 Thread	92646	Standard	3" x 10-11/16"	7,000	Not applicable	
		92825		5/8"-11 Thread					92647	Heavy Duty
		92827		1/2"-13 Thread	Composite	94500				
		92828		5/8"-11 Thread					13204, 13505, 13515, 13520	
		94507*	5/8" Bore	94508	5/8"-11 Thread	13101/102, 13202/205/207, 13300, 13503/506/508/516/518				
		94508	13204, 13505, 13515, 13520							
	90 mm x 100 mm	92863*	Aluminum	19 mm w/ 6 mm Slot	92651	Standard	100 mm x 289 mm	7,000	Not applicable	
	5" x 2-3/4"	92811	Aluminum	5/8"-11 Thread	94482	Standard	2-3/4" x 15-1/2"	3,500	13204, 13505/515/521/531	
		94492	Composite	5/8"-11 Thread					1/2": 13206, 13507	
		92935	Aluminum	Universal 1/2", 5/8" or 3/4" Bore					5/8": 13207, 13508	
		92936	Composite	Universal 1/2", 5/8" or 3/4" Bore						
	5" x 3-1/2"	92801	Aluminum	5/8"-11 Thread	94481	Standard	3-1/2" x 15-1/2"	3,500	13204, 13505, 13515, 13521, 13531	
		94472	Composite		92656	Heavy Duty			Not applicable	
		92805		Aluminum	M14 x 2 Thread	94481			Standard	1/2": 13206, 13507
		92803	Aluminum	Universal 1/2", 5/8" or 3/4" Bore	5/8": 13207, 13508					
		92937	Aluminum	Universal 1/2", 5/8" or 3/4" Bore						
		92938	Composite	Universal 1/2", 5/8" or 3/4" Bore						

4" Diameter Extension Right Angle Cut-Off Wheel DYNAECU4



- Model accepts 4" (76 mm) diameter Type 01/41 reinforced
- Cut-Off Wheels, with 3/8" (9.5 mm) center hole
- Composite grip absorbs vibration and reduces cold air transmission to operator
- Quick change lever controls, multi-position guard
- Adjustable exhaust

NIOSH APPROVED N95 PARTICULATE RESPIRATORS

The filter medium has an efficiency of at least 95% against airborne particulates 0.3 microns in size that are free of oils - dusts, metal fumes, microorganisms and non-oil containing mists. The shell doesn't absorb as much moisture from exhaled breath as other masks. The respirators maintain low breathing resistance all day long. The SP1940 particulate respirator offers the same level of protection, but may be used in the presence of oils and/or oil mists.



SP1501 (Not NIOSH Approved)



SP1730



SP1740

SP1940

N95 PARTICULATE RESPIRATOR

20 Per Pack	SP1730	\$27.78
w/Valve - 10 per Pack	SP1740	\$33.66

R95 Particulate Respirator

w/Valve - 10 per Pack	SP1940	\$38.41
-----------------------	--------	---------

Nuisance Dust Mask

50 per Pack	SP1501	\$16.98
-------------	--------	---------

NSX TURBO



- High-impact polycarbonate lens
- 99.9% UV Protection
- Mono lens design
- Scratch resistant coating on lenses
- Lightweight wrap-around lens
- Non-slip temples
- Available in 5 lens colors
- Meets ANSI Z87.1-2015

NSX TURBO

Clear Lens	SP5330	\$3.35
Amber Lens	SP5332	\$3.35
Light Blue Lens	SP5333	\$3.35
Indoor/Outdoor Mirror	SP5334	\$3.66

NSX



- Lightweight Full Wraparound Frame
- High-impact polycarbonate lens
- 99.9% UV Protection
- Single lens design
- Anti-fog and scratch resistant coating on lenses
- Lightweight wrap-around lens
- Meets ANSI Z87.1-2015

NSX

Clear Lens	SP5340	\$2.75
Yellow Lens	SP5341	\$2.75
Grey Lens	SP5343	\$2.75
Indoor/Outdoor Lens	SP5345	\$3.05

DIAMOND BACKS



- High-Impact Polycarbonate Lenses
- 99.9% UV Protection
- Anti-fog and Scratch Resistant Coating on Lenses
- Wrap-Around Design Hugs the Face
- Non-Slip Nose Piece
- Non-Slip Temples

DIAMOND BACKS

Clear Lens	SP0100	\$7.62
Grey Lens	SP0101	\$7.62
Smoke Lens	SP0103	\$7.62

WORKER BEES



- Impact-resistant polycarbonate lens
- 99.9% UV Protection
- Scratch-resistant coating on lens
- Fits over most prescription glasses
- Meets ANSI Z87.1-2015 and CSA Z94.3

Chief Clear Lens	SP5120	\$3.05
------------------	--------	--------

INDUSTRIAL WIPES

Multi Purpose Industrial cleaning Wipes, Gentle on Hands Tough on Grease & Dirt. 72ct. Perfect for majority of your work station or job site clean up projects.

These industrial wipes clean the toughest automotive grease, grime and dirt on hands, tools and work surfaces. Use the dual textured wipe to tackle both heavy and light soils.

- 72ct Pre-moistened heavy duty towel
- Works quickly to loosen, dissolve and absorb dirt, paint and grease

- Deep cleaning scrubbers remove embedded grime easily
- No rinsing, no drying, no residue and silicone-free

MULTI PURPOSE INDUSTRI/WIPE 72CT WIPE1539	\$48.62
---	---------



All filters can be used with Full Face Respirator and Reusable Half Mask Respirator

FULL FACE RESPIRATOR

This full face respirator offers a one size fits all design with a wraparound lens – ideal for long term use. The full size nose cup reduces the chances of fogging common with other full face respirators. All cartridges are interchangeable with Gerson half mask respirators. Mask includes a free lanyard!



Cartridges sold separately - see chart

Full Face Respirator - one size

SP9955 \$202.13

Tear Away Protective Lens (25 pack)

SP8711 \$3.34

DUST PARTICULATES ONLY

Pancake P100

SPXP100 \$6.51



SPXP100

P100 Particulate Cartridges

SPG70 \$10.26

P100 Particulate Cartridges - Rear vent

SPGX70P \$10.64



G78 MULTI GAS / P100

SPG78MGVP \$33.33

RESPIRATOR CARTRIDGES

These items work in conjunction with each other

SPG03

P95 Organic Vapor/Acid Gas Cartridges*
SPG03 \$9.87

N95 Particulate Pre-Filter - sold 10 per pack*
SPG95P \$28.59

Filter Retainer for use with N95 Particulate Pre-Filter*
SP172 \$2.62

***Add on item to SPG03 must be used with SP172**

LOW LEVEL - Chemical / Vapor

HIGH LEVEL - Deadly Chemicals / Vapors

DISPOSABLE DUAL CARTRIDGE HALF MASK RESPIRATOR



SP8211
SP8311

STAND ALONE - Use and Dispose

Our maintenance-free respirator comes completely assembled with organic vapor cartridges and P95 particulate replaceable pre-filters. This NIOSH approved respirator offers state-of-the art design, performance and comfort. It features a soft, lightweight elastomeric facepiece, and cradle suspension with easy-adjust headstraps that facilitate a comfortable and proper fit. The low, profile, swept-back design provides a greater field of vision and allows workers to use glasses or goggles. The P Series filters can be used with oil or solid particulates.

- Ready to use. No cartridges to replace and no spare parts to stock. Simplifies your inventory requirements.
- Reduces the record keeping necessary for OSHA compliance regarding maintenance and cleaning.
- Available in two sizes: Medium and Large.

Cartridges not replaceable

Disposable Half Mask Respirator

Medium	SP8211	\$37.48
Large	SP8311	\$37.48

REUSABLE HALF MASK RESPIRATOR

This dual cartridge half mask respirator is made of comfortable, non-irritating TPE and elastic strap and cradle suspension for comfortable wear. The construction with exhalation valves and two filtering cartridges offers very low breathing resistance while the low profile design allows for a wide field of vision and room for eyewear. Our half mask respirators will combat either organic gases and vapors or acidic gases and vapors, based on which cartridge is chosen, plus all solids and particulates **Cartridges sold separately - see chart.**



Reusable Half Mask Respirator

Medium	SP9200	\$23.56	SP9200
Large	SP9300	\$23.56	SP9300

GOAT SKIN TIG WELDING GLOVE



This glove has the strongest tensile strength and excellent tactile sensitivity. Best combination of flexibility and comfort. The SP4840 is an unlined Mig/Tig glove with a 5" russet split cowskin cuff for additional safety. It is sewn with DuPont™ Kevlar®, has a straight thumb and a self hem sewn cuff.

Medium	SP4840M	\$29.17
Large	SP4840L	\$29.17

BLUE LEATHER WELDING GLOVES



Blue regular split shoulder leather with a full sock jersey lining, cotton drill cuff lining and reinforced palm.

SP4501	\$27.26
--------	---------

BULLET EARPLUGS



Tapered shaped offers the most comfortable fit for ear canal. It has an extremely soft foam seals without pressure. A smooth surface help to repel dirt. Meets ANSI S3.19 (METHOD FOR DETERMINING NRR) requirements Corded. NRR 32

Resistor Bullet Earplug Uncorded NRR 32		
200/Box	SP6100	\$58.53
Resistor Bullet Earplug with Cord NRR 32		
100/Box	SP6101	\$64.63

ECON LEATHER PALM



This glove features "C" grade shoulder split cowhide leather, full feature, assorted color fabric striped back, 2.5" rubberized safety cuff.

SP12010	\$6.76
---------	--------

DRIVER'S GLOVE



The 3204 drivers gloves feature; premium cow grain leather palm, brown split leather back, sewn with Dupont™ Kevlar®,shirred elastic back, rolled hemmed, and a keystone thumb pattern.

Medium	SP3204M	\$21.66
Large	SP3204L	\$21.66
X-Large	SP3204XL	\$23.16

DISPOSABLE NONWOVEN POLYPROPYLENE COVERALL

This coverall protects from harmful paint overspray, sanding dust, dirt, grease, grime, and pesticides.

It's made from polypropylene non-woven material that's lightweight and comfortable. Elastic on wrists and ankles create an even barrier of protection; plus, it's washable so you can reuse.

Large	PROTECTIVESUITL	\$17.53
X-Large	PROTECTIVESUITXL	\$17.53
XX-Large	PROTECTIVESUITXXL	\$17.53
XXX-Large	PROTECTIVESUITXXXL	\$17.53



KLINGSPOR is pleased to offer disposable protective gloves. Almost every manufacturing facility has applications where latex and/or nitrile gloves are used. They may be used directly in the manufacturing process or simply in maintenance operations. Three versions of our KLINGSPOR gloves are available - regular powder-free latex, 5 mil powder-free blue nitrile and 6 mil powder-free black nitrile.

THICKSTER (SAS) LATEX EXAMINATION GLOVE



14 MIL POWDER FREE - 50 PER BOX

MEDIUM	LATEX6602	\$29.13
LARGE	LATEX6603	\$29.13
EXTRA LARGE	LATEX6604	\$29.13
XXLARGE	LATEX6605	\$29.13

LATEX GLOVE

POWDER FREE - 100 PER CANISTER

MEDIUM	LATEX659220	\$16.73
LARGE	LATEX659320	\$16.73
EXTRA LARGE	LATEX659420	\$16.73



KEVLAR SLEEVE WITH LEATHER PAD

Applications: Assembly Line Production, Automotive Assembly, Mechanics, Carpentry, Construction, Glass handling, Janitorial, HVAC, and more.

SP9374TL / 2 PER PACK\$21.23

BLACK NITRILE GLOVE



7 MIL POWDER FREE

SMALL	NITRILE-KL-BLACK-S	\$24.70
MEDIUM	NITRILE-KL-BLACK-M	\$24.70
LARGE	NITRILE-KL-BLACK-L	\$24.70
XLARGE	NITRILE-KL-BLACK-XL	\$24.70
XXLARGE	NITRILE-KL-BLACK-XXL	\$24.70

ASTRO GRIP



6 MIL - 100 PER BOX

These 6 mil thick gloves are powder-free and the bright orange color reveals any grease or dirt. They have dual sided scale grip and are superior puncture and abrasion resistant.

MEDIUM	NITRILE66472GRIP	\$30.48
LARGE	NITRILE66473GRIP	\$30.48
X-LARGE	NITRILE66474GRIP	\$30.48
XX-LARGE	NITRILE66475GRIP	\$30.48

NITRILE COATED



13 gauge nylon with gray flat nitrile palm and fingers.

MEDIUM	SP9679M	\$5.07
LARGE	SP9679L	\$5.07
EXTRA LARGE	SP9679XL	\$4.88

LATEX COATED GRIPPING



10 Gauge Cotton/Polyester Shell, Latex Palm & Fingertips, Knit Wrist

MEDIUM	SP9688M	\$5.39
LARGE	SP9688L	\$5.39
X-LARGE	SP9688XL	\$5.39

ULTRA TECH CUT PRO



10 Gauge Kevlar®/Fiberglass/ Stainless Steel Shell, Black PU Coated Palm. Level 4 cut resistant. Polyurethane palm and fingers for additional grip and abrasion resistance

Small	SP93891PUS	\$22.32
Medium	SP93891PUM	\$22.32
Large	SP93891PUL	\$22.32
X-Large	SP93891PUXL	\$22.32



Shop Pads & Accessories

SMART PINSTRIPE ERASER



A 3 1/2" molded rubber pad with a 5/16"-24 thread arbor used for pinstripe removal. Used with the 400E-AR arbor.

Item #	Description	Price
ASTRO400E	Eraser Pad	\$29.74
ASTRO400E-AR	Arbor	\$5.63

PAINT PENS

Item #	Description	Price
DY84003	White	\$10.26
DY84004	Yellow	\$10.03
DY84005	Orange	\$9.33
DY84006	Red	\$10.37



HAND PALM SANDER

This pad is a convenient tool for all hand sanding applications and is available in 5" and 6" diameters.

FPS-35V	Molded Hand Palm Sander 3" x 5"	\$22.08
FPS-50V	Hand Palm Sander 5" x N/H	\$22.08
FPS-60V	Hand Palm Sander 6" x N/H	\$22.08

RECIPROCATING SAW BLADES

SLM6 18 teeth
5/pack \$11.55



DRILL BITS

ASTRO9012 1/8" Drill Bits \$16.96
12 per pack (double sided)

ASTRO1721 Spot Weld Bit \$41.02



SAW BLADES

ASTRO5SAW 24 TEETH \$3.29
ASTRO5SAWR 32 TEETH \$3.29



SANDING BOARD

SIZE: 2-3/4" X 15"

FJ27515V
\$93.26

FJ27515H
\$93.26



Regular Sanding Blocks

SB-1 SOFT BLOCK

The original flexible sanding block features two different densities to achieve the ultimate in block sanding of curved or irregularly shaped surfaces.

Size: 2-5/8" x 5-1/4"

Application: Wet & Dry Sanding, Color Sanding



MOTOR00746 \$8.33

HOLEY TERROR

This unique two-sided block features a blue side with holes which act like a grater for 30% faster cutting. Black side is for less aggressive blocking.

Size: 2-5/8" x 5-1/4" \$

Application: Fast Blocking, Filler Sanding, Dry Sanding



MOTOR00751 \$12.25

BB-1 /SOFT BACKER BLOCK BBS-1 /HARD BACKER BLOCK

Soft and flexible for scuffing areas not accessible to rigid blocks. Designed to evenly distribute pressure, imparting an even tooth over the entire panel in a single pass.

Size: 4" x 6" **Application:** Scuffing

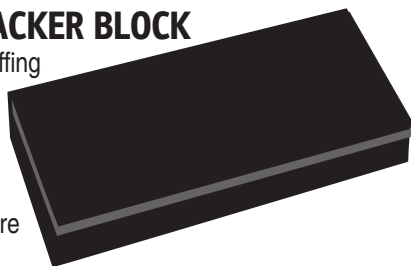

MOTOR00739	Soft	\$11.12
MOTOR00740	Hard	\$14.19

MB-1 MEMORY

A firm vinyl side offers extreme curving power for fender crowns and motorcycle tanks. Other side features soft yet dense memory foam to reduce pressure on ribs, louvers, etc.

Size: 2-5/8" x 6-1/2"

Application: Dry Sanding, Color Sanding

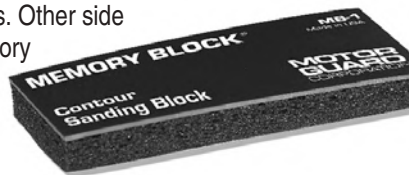

MOTOR00738 Backer Block Scuff Pad - Hard \$10.14

MOTOR00739 Backer Block Scuff Pad - Soft \$11.12

Big Sanding Blocks

HOOK FACED BIG BLOCK

Hook Faced Big-Blocks in 6-1/2" (BGK6-1) and 12" (BGK12-1) lengths. Grips looped backed abrasive sheets firmly while providing power and slight flexibility.

MOTOR00764	- 6"	\$13.49
MOTOR00767	- 7" - 12"	\$19.33



STANDARD BIG BLOCK BG12

Maximum length Big-Block for fast blocking over large, flat areas. Provides enough flex for slightly curved panels.

Size: 2-5/8" x 12"

Application: Dry Sanding, Filler Sanding, Blocking

MOTOR00732 \$18.40



BGR6-1 RIGID BLOCK

An ultra-rigid sanding block that flexes just enough slightly to follow slightly curved surfaces. Use this comfort-grip block for high production blocking and other demanding applications.

Size: 2-5/8" x 5-1/2"

Application: Aggressive Blocking, Filler Sanding

MOTOR00793 \$12.80



HOLE SIDE BIG BLOCK

This unique Big-Block features a hole side that acts like a grater for faster cutting. Other side is for less aggressive blocking.

Size: 2-5/8" x 6-1/2"

Application: Fast Blocking, Filler Sanding, Dry Sanding

MOTOR00726 \$13.82



HAND BLOCK

Ergonomically designed to fit your hand, this hand block uses standard 6" discs for hand sanding. The pad is available for use with PSA and Kling-On® discs.



HAND550V6	Hook & Loop - for use with 6" Disc	\$26.51
HAND550P6	PSA - for use with 6" Disc	\$26.51

SOFT SIDE BIG-BLOCK

A soft-sided Big-Block for fine color sanding quickly over large areas. Rigid inner layer prevents transfer of finger marks.

Size: 2-5/8" x 6-1/2"

Application: Wet & Dry Sanding, Color Sanding

MOTOR00727 \$12.52





SPRAY GUNS & ACCESSORIES

Transtar HVLP professional spray guns are designed to produce high quality finishes in all applications. The spray guns are equipped with stainless steel fluid tips and needles for use with all types of coatings.

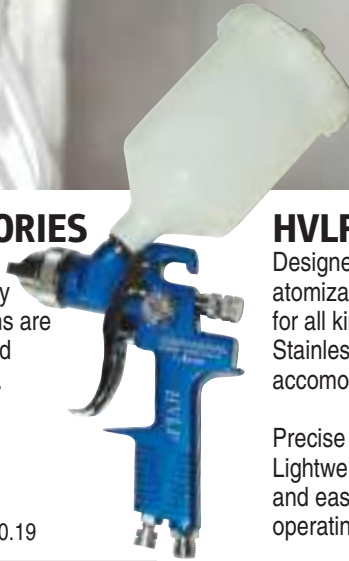

HVLP SPRAY GUN

Designed to provide equal atomization and particle size for all kinds of surface painting. Stainless steel needle and nozzle accommodate a variety of coating.

Precise air cap set. Lightweight, ergonomic design and easy trigger pivot reduces operating fatigue.



Item #	Description	
TRANS6617	HVLP Gun (1.7mm)	\$370.19
TRANS6603	1.3 Needle Nozzle Rebuild Kit	\$143.42
TRANS6608	1.0 Needle Nozzle Rebuild Kit	\$27.08
TRANS6621	HVLP AR-200 air Regulator 1/4"	\$65.88
TRANS6630	1000cc Aluminum Spray Cup	\$69.46
TRANS6643	Cup Lid Seal for 6613 / 6614 / 6617	\$1.54
TRANS6644	Cup Lid Seal for 6618	\$1.99
TRANS6632	125cc Aluminum Spray Cup with Lid	\$13.51

Item #	Description	
KAISP-PG-US	YELLOW PRIMER/GUN 1.4MM/2.2MM	\$58.29
KAISP-A604	HVLP SP/GUN 1.3MM 4.1-4.5 US	\$158.69
KAISP-A605	HLVP SP/GUN 1.3 5.5 US / 400CC	\$171.39

TEKNA

Item #	Description	
DT704198	TEKNA CLEARCOAT SPRAY GUN - UNCUPPED - 1.2, 1.3, AND 1.4MM	\$925.25
DT703893	TEKNA BASECOAT SPRAY GUN - UNCUPPED - 1.3, 1.4MM	\$896.79
DT703567	TEKNA PROLITESPRAYGUN - UNCUPPED - 1.2, 1.3, AND 1.4MM	\$920.82

TRANSTAR

Item #	Description	
TRANS6613	TRANSTAR HVLP SPRAY GUN -1.3MM	\$371.95
TRANS6614	TRANSTAR HVLP SPRAY GUN -1.4MM	\$371.95
TRANS6617	TRANSTAR HVLP SPRAY GUN -1.7MM	\$370.19
TRANS6618	TRANSTAR HVLP TOUCH-UP SPRAY GUN -1.0MM	\$332.92

ACCESSORIES

Item #	Description	
DT702576	TEKNA 900CC ALUMINUM CUP	\$152.07
TRANS6630	TRANSTAR 1000CC ALUMINUM CUP	\$69.46
MIXTIP	MIX TIP LARGE	\$4.19
MIXTIP	MIX TIP SMALL	\$3.34





Model Number	Description	Qty
Paint Guns		
D802342	HVLP 2 Gun Set (PAINT & TOUCH UP)	1
D803485	HVLP Primer Pack (2 gun primer pack)	1
Disposable Lids and Liners		
DPC-600	34 oz./1000 ml Disposable Cup/Lid	32
DPC-601	24 oz./710 ml Disposable Cup/Lid	32
DPC-602	9 oz./265 ml Disposable Cup/Lid	32
DPC-503-K24	3 oz. Disposable Cup/Lid	24
Reusable sleeve/Lid		
DPC-607	9 FL. oz./265 ml Reusable sleeve/lid	2
DPC-606	24 FL. oz./710 ml Reusable sleeve/lid	2
DPC-608	34 FL. oz./1000 ml Reusable sleeve/lid	2
Disk Filters and Barrel Filters		
DPC-42-K24	24 oz./34 oz 125 Micron Disk filter	24
DPC-66-K24	24 oz./34 oz 200 Micron Disk filter	24
DPC-65-K24	9 oz. 125 Micron Disk filter	24
DPC-67-K24	9 oz. 200 Micron Disk filter	24
DPC-27-K10	Barrel Filter 200 Micron (course)	10
DPC-17-K10	Barrel Filter 300 Micron (fine)	10
DPC-14-K10	Barrel Filter 600 Micron (very fine)	10
Measuring Guides		
DPC-39-K10	9 oz. Measuring Guide	10
DPC-35-K10	24 oz. Measuring Guide	10
DPC-40-K10	34 oz. Measuring Guide	10
Accessories		
DPC-22-K24	Disposable Funnel	24
Kits		
DPC-654	Demo Trial Kit Adapter for DeVilbiss/TEKNA/Finishline/Binks (1), 24 oz. Reusable Sleeve & Lid (1), 24 oz. Disposable Cups & Lids (8), Plugs (5), Disk Filter 125 Micron (4), Barrel Filter 300 Micron (1), Funnel (1), Measuring Guide (1), How-to-Use Guide	1
DPC-650	Shop Start Up Kit 24 oz. Reusable Sleeve & Lid (3), 9 oz. Reusable Sleeve & Lid (1), 24 oz. Disposable Cups & Lids (32), 9 oz. Disposable Cups & Lids (32), 24/34 oz. Disk Filter 125 Micron (12), 9 oz. Disk Filter 125 Micron (12), Barrel Filter 300 Micron (10), Barrel Filter 600 Micron (10), Funnel (24), 3 oz. Disposable Cups (3), Cleaning Brush, Cleaning Bottle, Magnets (5), How-to-Use Guide	1
Adapters		
DPC-43	DeVilbiss Full Size, Plus, GTi, RPI, JGA • Tekna • Binks M1G • Sharpe Cobalt, Platinum & Titanium (Use DPC-31 for FinishLine 2 & 3)	1
DPC-26	Accuspray Issac	1
DPC-31	DeVilbiss FinishLine 2 & 3	1
DPC-10	Sata NR2000, RP, KLC, MCB, QCC, 96719 & Jet 90 • Startingline Full Size	1
DPC-11	Sata NR 92 & 95 • Iwata LPH-400 & W400LV • Astro GF14, 17 & 20S • Sharpe Finex FX200 & FX300 • Transtar 6613,14,17	1
DPC-13	Sagola	1
DPC-23	DeVilbiss SRI, SRIW, SRIPro • Binks Cub	1
DPC-52-K1	Sata QCC & Threaded (Mini Detail)	1
DPC-64	DeVilbiss Starting Line (Mini Detail)	1
DPC-69-K1	DeVilbiss & Binks Suction Guns	1
DPC-78	Iwata Supernova, Air Guns • W300	1
DPC-500	3M Conversion Adapter - Converts 3M PPS adapter to use with DEKUPS system.	1
DPC-501	Sata QCC Full Size, 3000, 4000	1
DPC-504	SATA QCC Full Size	1
DPC-81	StartingLine Full Size • Sharpe Finex FX1000, 2000 & 3000	1
DPC-85	Accuspray Disposable Head	1
Air Dryer		
DAD-1	Desiccant Refill for DAD-507	1

SAFETY SCRAPE MINISCRAPER BLADES

The razors have two sides with different thickness. Mini scraper holds the blade safely.



MS204 Miniscraper Replacement blades (20 per bag) \$6.08
MS147K Yellow Miniscraper with 5 yellow blades \$6.68

MINI SNAP-BLADE KNIFE

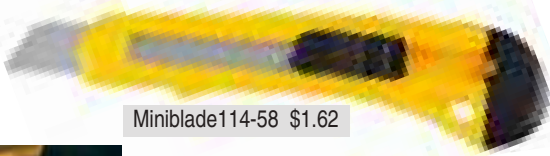

Miniblade114-58 \$1.62



#128PL SOUND DAMPENING PAD

Reduces noise and vibration in all types of vehicles. Can be stacked in multiple layers to build depth of dampening. Enhances car audio system's quality & amplifying power. Textured pad surface matches OEM applications.

#SD-PAD128 6 pads per pack

BARGAIN BOX OF RAGS

This ready-to-go 4.5 lb. box full of soft white cloths are pre-washed so they are lint free and clean of any contaminant's. Every "rag" is a generous size and can be cut into smaller pieces. They're also great for a wiping cloth or a clean-up rag.



BC33010 \$36.93

11 PC. FASTENER AND MOLDING REMOVAL TOOL

For use on internal and external vehicle molding and trim fasteners.

- Plastic construction of tools prevents scratching and damage to vehicle paint, leather, chrome, etc.
- Set includes: 6" Remover - Wide Type, 7" Remover - Pull Type, 8" Remover - Handy Type, 7" Remover - Narrow Type, 8.5" Upholstery Clip Remover, 8" Angled Clip Panel Remover, 8" Flat Clip Panel Remover, 8" Panel Remover, 8" Sharp Panel Remover, 8" Clip Panel Remover and 8" Straight Panel Remover



ASTRO4524 \$65.21

SINGLE EDGE NO. 12 RAZOR BLADES



BLADE111-12 #12 Blades. 100qty. \$14.75

MIX BOARDS

Here's a convenient and handy tool for mixing. Mix Boards with disposable sheets. Each masonite board has a strap on the back to hold it firmly to your hand and has 100 disposable non-porous sheets padded on the front. Simply mix on the top sheet, then remove it for the next mixing.



Back



MIX BOARD 1800 \$33.42

EVERCOAT MIXING BOARDS

EVERCOAT155 ACRYLIC MIXING BOARD \$13.02



STEEL SPREADERS

SPREADER1101 4" (3 pack) \$19.13

PLASTIC SPREADERS

Get more work finished in less time. Available in 3" x 4" and 3" x 5" sizes.

H10-07 100/Box 3" X 4" Plastic Spreaders \$85.59

H10-09 100/Box 3" X 5" Plastic Spreaders \$120.92



ABRASER RUST REMOVER 2-PACK

Simply use the block like an eraser, rubbing firmly on the surface. Can be used both wet or dry. Two pack includes: medium and fine grits.

ABSR02 ABRASER SANDFLEX STICK GRIT 120 & 240 \$10.54



POLISHING PADS



Item#	301G	301GY	330G	320G
Size	3"	3"	3"	3"
Type	White Twisted	Yellow	Yellow Foam	Black Foam
Blend	100% Wool	Wool Blend	Compound/Polish	Finish/Polish
Ply	4	4	n/a	n/a
Per Pack	(2pk)	(2pk)	(2pk)	(2pk)
Price	\$23.27 per pad	\$12.28 per pad	\$9.04 per pad	\$8.55 per pad

TP4 3" KIT- KIT Includes: 1 each of 301G, 301GY, 320G, 330G, 3" backing pad + 2 adaptors, 1 for drill + 1 for a pneumatic polisher. **\$69.49**

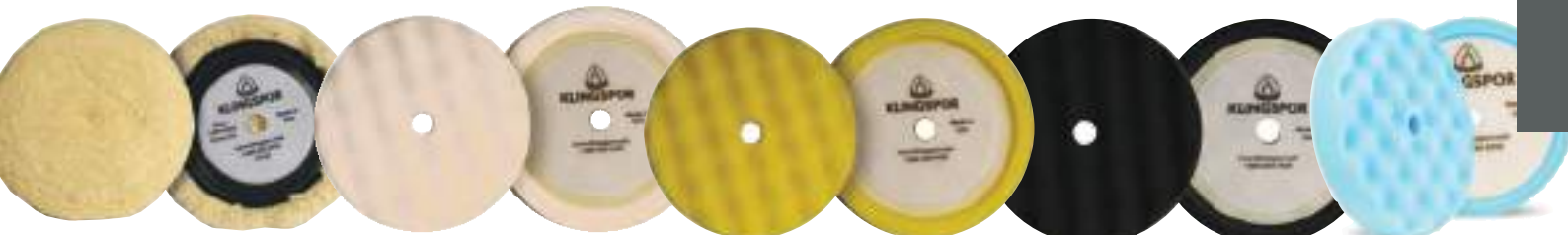

Item#	7503G	899WG	830WG	820WG	852WG
Size	7"	7"	7"	7"	7"
Type	100% Grip Wool	White Convolutated	Yellow Convolutated	Black Convolutated	Light Blue
Blend	Compound Pad	Course Cutting	Medium Cutting	Finishing	Ultra Finish
Ply	4	N/A	N/A	N/A	N/A
Per Pack	(1pk)	(1pk)	(1pk)	(1pk)	(1pk)
Price	\$24.38	\$34.15	\$25.02	\$25.02	\$25.02



Item#	658Y	752R	830RH	820RH
Size	6" x 5/8-11 thread	6"	6"	6"
Type	n/a	Twisted Wool Pad	Yellow Hex	Black Hex
Blend	Backing Pad	w/centering ring	Medium Cutting w/centering ring	Finishing w/centering ring
Ply	4	n/a	n/a	n/a
Per Pack	(1pk)	(1pk)	(1pk)	(1pk)
Price	\$34.04	\$26.84	\$24.78	\$24.78

TP1R KIT - Kit Includes: 1 each of 820RH, 830RH, 752R & a 658Y Backing Pad **\$104.49**

Tapes

KLINGSPOR's 777 Gold Standard Performance Tape

This masking tape that has been designed for high temperatures, automotive and industrial applications. KLINGSPOR's 777 is solvent and thinner resistant, provides instant adhesion, possesses excellent adhesion properties and sticks to a wide variety of irregularly shaped surfaces. KLINGSPOR's 777 possesses good mechanical strength and is compatible with solvent and water paints and leaves no adhesive transfer when removed. Exceptional performance in automobile repair, professional body shops and various industrial applications.

Item #	Size	Sleeve	Case	Price
MTAPE777-075	3/4"	12	48	\$5.17
MTAPE777-150	1-1/2"	6	24	\$10.34
MTAPE777-200	2"	6	24	\$13.87



KLINGSPOR's 555 Silver Series Tape

This masking tape that has been designed for high temperatures, automotive and industrial applications. KLINGSPOR's 555 is solvent and thinner resistant, provides instant adhesion, possesses excellent adhesion properties and sticks to a wide variety of irregularly shaped surfaces. KLINGSPOR's 555 possesses good mechanical strength and is compatible with solvent and water paints and leaves no adhesive transfer when removed. Exceptional performance in automobile repair, professional body shops and various industrial applications.

Item #	Size	Sleeve	Case	Price
MTAPE555-075	3/4"	12	48	\$3.84
MTAPE555-150	1-1/2"	6	24	\$7.69
MTAPE555-200	2"	6	24	\$10.25



PG Tape is tear, moisture & solvent resistant. It is perfect for wet sanding and provides excellent cornering - great for custom jobs as this tape provides clean removal for crisp paint lines. It is a beige, high temperature, fine crepe paper masking tape with pressure-sensitive natural rubber adhesive. Designed for clean removal from a variety of surfaces after exposure to oven temperatures up to 250°F (121°C) for 30 minutes (times and temperatures are determined by surface). Its easy handling, smooth crepe backing exhibits high strength, excellent conformability to irregular surfaces and exceptional cornering. Provides resistance to paint flaking and a clean, well defined paint line.

Item #	Size	Sleeve	Case	Price
MTAPE-PG075	3/4"	12	48	\$8.81
MTAPE-PG100	1"	9	36	\$12.04
MTAPE-PG150	1-1/2"	6	24	\$18.46
MTAPE-PG200	2"	6	24	\$24.64



AM Tape

AM (AquaMask™) is a cost-effective masking tape designed to perform in many demanding automotive refinishing applications. The rubber-based adhesive provides secure adhesion to both painted and bare metals and plastics, yet removes cleanly without adhesive residue, paint "flaking" from backside or surface staining. Compatible with both water and solvent-based paints. UV-resistant up to three (3) days. Temperature resistant up to 250°F (107°C) for 30 minutes.

Item #	Size	Sleeve	Case	Price
MTAPE-AM-075	3/4"	12	48	\$6.58
MTAPE-AM-150	1-1/2"	6	24	\$14.51



Premium Foam Masking Tape

is specially designed polyurethane foam structure Highly absorbent to avoid any leaking and paint run Flexible Easy clean up and removal Solvent resistant Easy roll release in a box dispenser Easy to shape on contours, mask and seals all jamb Good adhesion to vehicle surface Withstands paint booth bake cycle Prevents overspray from penetrating into the jamb Improves productivity by reducing the time required to mask jambs with tape and masking paper. Leaves no residue.

Item #	Size	Price
FOAM-MTAPE	1/2" x 55yd	\$48.57



Double-Sided Foam Attachment Tape

This high quality permanent attachment tape offers an easy release liner and an acrylic adhesive for attaching letters, emblems or badges. It is highly resistant to vibration, stress and weather.

TRANS4580	1/4" X 60 yards	\$40.93
TRANS4595	1/2" X 60 yards	\$66.44
TRANS4598	7/8" X 60 yards	\$40.94
TRANS4516	Tape Adhe Promoter	\$66.44



FM-71 - Finline Vinyl Masking Tape

uses thermally stabilized PVC backing with a rubber-based pressure-sensitive adhesive. Designed to offer a high degree of conformability without excessive stretch. Will hold and cleanly remove from surfaces in the presence of 250°F (120°C) for at least 30 minutes. Assures the user of a secure lay-down, no-residue-on, de-mask and a sharp, clean separation line. FM71 "fine line" masking tape uses thermally stabilized PVC backing with a rubber-based, pressure-sensitive adhesive.

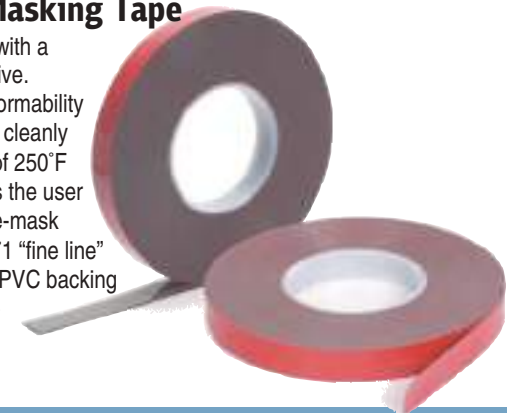

Tapes & Masking

Clear Mounting Tape

Vinyl tape designed for highly detailed jobs, when conformability, flexibility and/or high temps are required. Widely used to paint color line separation. Abrasion and solvent resistant. Removes cleanly.

Item #	Size	Price
MTAPE-FM71-0125	1/8"	\$23.07
MTAPE-FM71-025	1/4"	\$26.95
MTAPE-FM71-050	1/2"	\$39.58

TrimFast Masking Tape

TrimFast is an innovative product that will improve the quality of your work and increase productivity. It is designed to be used on flush mount and inset moldings around windshields and other automotive glasses. TrimFast actually pulls the molding away from the sheet metal, thus eliminating overspray and paint lines on or around the molding.

Item #	Sizes	Price
TRIMFAST	3/4" or 2"	\$82.08



Plastic Sheeting

This anti-static plastic sheeting is excellent for protecting exteriors from paint and dust. High tensile strength sheeting resists static, is tear-resistant and can withstand at very high temperatures. Our CLING PLASTIC SHEETING provides complete overspray protection as it clings to the vehicle while the paint clings to the plastic – with no flaking. Easy for one person to handle, this sheeting will save on masking paper, tape and time costs.

Item #	Description	Size	Price
SHEETING820	"Cling" Plastic Sheeting	16' x 350'	\$67.12
SHEETING821	"Cling" Plastic Sheeting	20' x 250'	\$95.83

Disposable Wheel Bag Maskers

Here's the ticket for total tire masking at a very affordable price - Plastic Wheel Bag Maskers. They protect against paint overspray, dust, dirt, and other contaminant's during finish repair. A built-in "cling" feature enables the bag to hug the tire for complete protection, plus it keeps the bag out of the way of air hoses and body technicians. The bags are made to hold the paint overspray to the bag so there's no blow-off or flake-off during spraying or removal of bag from tires.

Item #	Description	Qty Per Box	Price
WHEEL BAG	16" Sport Utility/Light Truck tires	50	\$102.53

Reusable Wheel Bag Maskers

This four pack of deluxe wheel maskers is made of a heavy duty spun woven material that provides maximum protection and longevity. Fits up to 18" wheels.

Item #	Description	Quantity	Price
ASTRO9004	Wheel Maskers (canvas) Fits up to 18" wheels	4 pack	\$60.51



REUSABLE WHEEL BAG MASKERS



KLINGSPOR's Krash Wrap - 36

36" wide self-adhering wrap covers cracked and broken windows on cars, SUVs, trucks, minivans and more. Protects vehicle or cab interior from exposure to rain, wind, snow, dirt, etc. Interior or exterior. 100 foot roll 3mil. ITEM#KRASHWRAP



K-LINER BEDLINER KIT AND SPRAY GUN

- 10 times tougher than other bedliners
- Can be applied onto almost any surface, including: metal, plastic, wood and concrete
- Easy to apply; Variety of finishes
- Designed to cover an average truck bed
- The only limit is your imagination! black or tintable paint choices



K-LINER \$172.76

CUPRAN® SPECIAL HAND CLEANER

A highly skin compatible solvent is used to help Cupran® Special break down dried-on paints, adhesives and urethanes. Unlike competitive products that use pumice as "friction" to remove paint, Cupran® Special breaks down the paint, adhesives and urethanes by employing a superior solvent and using a safe scrubber (walnut shells) thus not damaging skin in the process. Cupran® Special also uses a very highly specialized "super absorbent" to encapsulate contaminants on the skin, lifting them off, thus allowing the product to work effectively.

8187406 \$61.24

KRESTO® HAND CLEANER

A skin compatible solvent/detergent is used versus unknown petroleum based and/or organic based "d'limonene" (better known as "Orange" or "Citrus") solvent. The unique formula of Kresto® helps create a closer to neutral pH value to the skin, unlike competition. We use very skin compatible and "environmentally friendly" natural walnut shell scrubber versus our competitors harsh volcanic rock or "sand-like" scrubbers (such as plastic and pumice) which cause micro-abrasions to the skin.



8704506 \$61.34



STOKO® DISPENSER

This convenient unit will easily dispense a portion of your desired hand cleaner for quick clean-up and less mess.

Item #	Description	Size	Price
8187406	Cupran Special Paint Remover for Hands	2000ml	\$61.24
8704506	Kresto Extra-Heavy Duty Hand Cleaner	2000ml	\$61.34
8980801	Dispenser		\$14.44

ALL PURPOSE WIPER AND TOWEL PACKS

This is a high quality 4-ply towel excellent for wiping spills, soaking up oil, machine and tool wiping, wiping glass, dry wiping, with solvents and panel prepping.

Item#	Description	Price
WIPE93014	250 COUNT PREP WIPE	\$65.40
WIPE86870	300 SHEETS CHAMPION SELECT	\$43.62
WIPE1539	MULTIPURPOSE INDUSTRIAL WIPES	\$49.03
450337	200-COUNT SHOP MAX WIPES	\$41.87



TACK CLOTHS

Here is your tack rag solution. We carry 3 different tack rags from Gerson to meet your needs. All of the below tack rags are wax & silicone free, compatible with all paints & are approved by leading Auto, Marine, Aerospace and Electronics manufacturers. So whether you are looking for the new TEK prep or the standard base/clear tack rag we have you covered.

- TEK prep is made from a lint free continuous-filament knit polyester, with stitched edges that does not shed fibers or generate lint from rubbing and the wave knitted fabric picks up all particulates. TEK prep has a non-transferring formulation that is a dry tack that glides smoothly for a very long life.
- Blend prep is made from a Blue synthetic non-woven material, Low tack formulation to remove surface particles without harmful residues.
- 2000 Basecoat/Clear coat is made from a Blue cotton standard mesh material, Low tack formulation to remove surface particles without harmful residues.



Item #	Cloth Size	Description	Qty per box	Price
TACK020009C	18" x 18"	TEK PREP	12	\$9.17
TACK020008C	9" x 18"	BLEND PREP	12	\$24.94
TACK020002B	20" x 16"	BASECOAT/CLEARCOAT	12	\$29.18





DISPOSABLE SPRAY GUN FILTER

Disposable compact air filter removes moisture and impurities from airlines before it reached the spray gun. The super sensitive filter will effectively remove oil, aerosols, smoke, condensed moisture and virtually all solid particles.

MOTOR00112 Spray Gun Filter (Pack of 2) \$19.26



KLINGSPOR MIXING CUPS

Available in quarts pints and lids that fit both sizes.

MIXCUP-PT	PINT	\$0.56
MIXCUP	QUART	\$0.73
PINT-QT	QUART LID	\$0.62
MIXCUP-PT-LD	PINT LID	\$0.87

PAINT BOOTH INTAKE FILTERS



Item Number	Description	Qty	Price
VIL6901010	Andreae Filter 36" x 30"	1 per box	\$168.39
VIL6901489	20" x 20" Winair Intake	50 per box	\$9.22
VIL73074904	20" x 20" Standard Exhaust Filter	20 per box	\$46.20

THE PREVAL SPRAY GUN

This versatile, economical solution is a perfect complement to your present spray equipment. It proves its worth every day with its economy, ease of use and superior performance.

- Saves time and money, assures professional results every time
- Portable and disposable. Spray up to 16 oz.
- Economical, easy to use
- Get perfect color matching - using your own paints
- No wires or hoses to get in the way.



PREVAL267	Power Spray Unit & Reusable Container	\$23.36
PREVAL268	Power Spray Unit	\$18.75
PREVAL269	Reusable Product Container	\$5.91

METAL PAINT CANS

Item#	Description	Qty	Price
CAN608	Gallon Can w/Lid - Bway	34/case	\$13.24
CAN609	Pint Can w/Lid - Bway	50/case	\$6.22
CAN639	Quart Can w/Lid - Bway	56/case	\$6.67



MASTER SPRAY GUN CLEANING KIT

7 Piece Micro Needle Set With Handle 5 Piece Precision Mini Brush Set With Split Ring Holder 2 Piece End Brush Set With Handle Power Brass Pick-Up Tube Brush 12" Pick Up Tube Brush.

ASTRO4544 Gun Cleaning Kit \$79.06



PANEL STAND 557012

Lightweight panel stand with 300lbs. capacity. Bumper extension bar can easily be adjusted for any position. Great for working on bumpers and other automotive parts.

SPECIFICATIONS:

Maximum Capacity: 300lbs Adjustable Height: 34" to 47" High
 Stand Dimensions in Completely Folded Position: 49 1/2" H x 23 1/2" W x 6" D
 Maximum Stand Dimensions with Extension Bars Fully Extended:
 - Stand Adjusted to Maximum Height: Max. Height: 68" H / Max. Width: 65" W
 - Stand Adjusted to Minimum Height: Max. Height: 48" H / Max. Width 85" W
 Steel Tubing Construction with 1 1/2" (32mm) O.D. Round Tubing and 1-3/16" (30mm) O.D. Square Tubing. Weight: 18.7lbs

ASTRO 557012 \$232.86



PORTABLE WORK ASTRO STAND

The Astro 557003 500 Pound Capacity Portable Work Stand is designed for shops where space is an issue. They fold and are light enough to hang on a wall or store in a small space when not in use. They will hold up to 500 Lbs making this a must for all kinds of environments.

Range of use includes hobbyist, industrial, mechanical, manufacturing and body shops. ASTROSTAND \$117.38

EVERCOAT DIRT PIC

A unique tool crafted of surgical stainless steel and aluminum. Designed for the removal of foreign particles and bugs from a wet paint film.

EVERCOAT8001 Dirt Pic \$62.41



CHEESE GRATERS





















10" half-round convex blade used for faster stock removal and shaping curved surfaces. Ideal for work on fiberglass and removing filler (for cars and boats).

CHEESEGRATER295-12 \$11.09











More hole patterns available - consult intranet die list. 5% Upcharge on discs with 10 holes or more

Kling-On® Hole Pattern Availability

DISC SIZE	NO HOLE	5 HOLES	8 HOLES	9 HOLES	DYNABRADE EXTREME	16 HOLES	17 HOLES	FESTOOL 48 HOLE	5" CENTER HOLE
4 1/2"									
5"				 Festool 5/8" Center Hole  Festool 1/4" Center Hole					
6"				 Festool 3/4" Center Hole			 Festool 3/8" Center Hole	 MJ2	
8"									
11"									

PSA Hole Pattern Availability

DISC SIZE	NO HOLE	5 HOLES	6 HOLES	8 HOLES	16 HOLES
5"					
6"					
8"					

BELT SANDING MATERIAL / APPLICATION RECOMMENDATION CHART

GENERAL GUIDELINES - CALL FOR SPECIFIC INFORMATION

Operation	Material			Grit	
Abrasive Planing:	WOOD	Softwoods:	CS 311, CS 416	24-40	
		Hardwoods:	CS 308, CS 310, CS 412, CS 411		
	METAL	Soft Metals:	CS 311, CS 416, CS 920, CS 811YY	24-40	
		Hard Metals:	CS 308, CS 310, CS 412, CS 411, CS 922, CS 811YY		
Wide Belts:	WOOD	Primary	Softwoods:	CS 311, CS 416	40-60
			Hardwoods:	CS 308, CS 310, CS 412, CS 411	
	METAL		Soft Metals:	CS 311, CS 416, CS 920	40-60
			Hard Metals:	PS 61, CS 308, CS 310, CS 412, CS 411, CS 922	
	WOOD	Intermediate	Softwoods:	CS 311, PS 26, PS 28, PS 29, CS 416	80-120
			Hardwoods:	CS 308, CS 310, PS 22	
METAL		Soft Metals:	CS 311, CS 416, CS 920	80-120	
		Hard Metals:	PS 61, CS 308, CS 310, CS 412, CS 411, CS 922		
	WOOD	Finish	Softwoods:	CS 310, PS 26, PS 27, PS 29	150 & Finer
			Hardwoods:	CS 308, CS 310, PS 22	
	METAL		Soft Metals:	PS 21, PS 61, CS 311, CS 416	120 & Finer
			Hard Metals:	PS 61, CS 308, CS 310, CS 412, PS 20, PS 21	
Edge Sanding:	WOOD	Softwoods:	CS 311	80-180	
		Hardwoods:	CS 308, CS 310, CS 412		
	METAL	Soft Metals:	CS 311, CS 416	80-180	
		Hard Metals:	CS 308, CS 310, CS 412, CS 411		
Stroke Sanding:	WOOD	Softwoods:	CS 311, PS 26	80-180	
		Hardwoods:	CS 308, CS 310, PS 22		
	METAL	Soft Metals:	CS 311, CS 631	80-180	
		Hard Metals:	CS 308, CS 310, CS 631, LS 912 JF, CS 931 JF, GX931JF		
Mold Sanding:	WOOD		LS 312 JF, LS 309 JF, LS 318 JF	80-180	
Pump Drum Sanding:	WOOD		LS 312 JF, LS 309 JF, LS 318 JF	80-150	
Scroll Sanding:	WOOD		LS 312 JF, LS 309 JF, LS 318 JF	100-150	
Spindle Sanding:	WOOD		Spiral Bands, AO	100-150	
Flutter Sheet/Discs:	WOOD		LS 309J, LS 312 JF, LS 318 JF	100-150	
Portable Belt Sanding:	WOOD		LS 309 XH, CS 308, CS 310, CS 311, CS 411 Y, CS 416	60-150	
		METAL	CS 308, CS 310, CS 311, CS 412, CS 411, CS 416	24-120	
Orbital Disc Sanding:	WOOD	Bare Woods:	PS 29, PS 31, PS 33, PL 36, PS 36, PS 73W, VP 73W, FP 73W, CS 710 XF, FP 77, PS 77	80-180	
		Finished Woods:	PL 35, PS 11, FP 77, PS 77	220 up	
Backstand:	METAL	Grinding	CS 308, CS 310, CS 412, CS 311, CS 411, CS 920, CS 922, CS 811YY, CS 409	24-60	
		Finishing	LS 309JF, LS 312, CS 631, GX 533, GX 712, GX 931 JF, CS 931 JF, LS 912 JF	80-400	

PRODUCT RECOMMENDATIONS FOR SPECIFIC MATERIALS

ALUMINUM - Alumina Zirconia for rough grinding. Aluminum Oxide for general purpose grinding and finishing. Open coat is useful for softer types of aluminum. Silicon Carbide is sometimes used in abrasive machining, coil grinding, roll grinding, and wide belt deburring.

BRASS/BRONZE/COPPER/NON-FERROUS METALS - Aluminum Oxide is most common. Alumina Zirconia is used equally well. Silicon Carbide is sometimes used for finishing or polishing.

CAST IRON - For most types of cast iron, use Alumina Zirconia for rough grinding and Aluminum Oxide for grinding and finishing. For Chilled Cast Iron or Grey Iron, Silicon Carbide is sometimes used.

CHROME - Alumina Zirconia or Aluminum Oxide can be used. Mostly Aluminum Oxide.

CORIAN®/PLASTIC - Silicon Carbide or Stearate Aluminum Oxide products are recommended almost exclusively. Alumina Zirconia is sometimes used in rougher applications. Usually run wet, especially thermoplastics.

FIBERGLASS/GELCOAT - Aluminum Oxide almost exclusively in sanding operations. Alumina Zirconia is useful also in rough applications.

GLASS - Usually Silicon Carbide for any application. Occasionally Alumina Zirconia is used for flat stock or mirror stock. Glass is usually ground wet to reduce burning and breakage.

GRANITE/MARBLE/STONE - Silicon Carbide almost exclusively. Usually ground wet to reduce dust and eliminate burning.

LEATHER - Aluminum Oxide most widely used. Alumina Zirconia is popular with shoe manufacturers. Sometimes Silicon Carbide is found to be used. Open coats are also very common.

PAINT - Usually Silicon Carbide but sometimes Alumina Zirconia. Zinc Stearate materials common (PS 33).

RUBBER - Almost always ground with Silicon Carbide. Soft rubber or polyurethane is usually ground wet. Most other types are usually ground dry. Sometimes 24 grit Aluminum Oxide is used for heavy stock removal.

STAINLESS STEEL - Alumina Zirconia or Aluminum Oxide. Silicon Carbide is sometimes used for final finishing because a more consistent scratch pattern is achieved. For grinding Ceramic Aluminum Oxide or Zirconia is used with products that feature a multibond lubricant.

STEEL - Alumina Zirconia or Aluminum Oxide. Occasionally, Silicon Carbide will be used for final polishing on some applications.

TITANIUM - Ceramic Aluminum Oxide, or Alumina Zirconia for rough grinding.

WOOD - Aluminum Oxide for general purpose sanding. Alumina Zirconia can be used for planing operations and Silicon Carbide is often used when working with particle board.

COATED ABRASIVE SAFETY GUIDELINES

1. Eye protection should always be worn when using any machinery-operated abrasive product (A.N.S.I. Standard Z87.1). Body protection should also be worn whenever appropriate; arm guards, leather gloves, and aprons. Loose clothing, jewelry and hair should always be secured before using any powered machinery.
2. Machinery should always be maintained in good working order. Proper electrical controls should be easily reached and in good working order. Safety guards on machines should never be removed. Machinery should be disconnected from the power source before making any abrasive or machine adjustments.
3. Proper dust control is essential. Always observe OSHA regulations regarding dust collection. Dust masks are recommended to minimize dust inhalation. Dust collection systems should be properly maintained and cleaned frequently.
4. Never use a coated abrasive product which is cut, creased, or otherwise damaged. Observe proper storage conditions.
5. Proper machinery use:
 - A. Always run lap joint belts in proper direction.
 - B. Jog the machine to start abrasive belt tracking, rather than full-power starts.
 - C. If unusual ticking or bumping noises are heard on a running abrasive belt, check belt and machine for possible damage.
 - D. On offhand applications, present the workpiece to the abrasive belt below the center of a contact wheel.
 - E. Proper belt tension should always be maintained.
 - F. Belt tracking should be properly adjusted.



Look for these safety warnings in your workplace and on abrasive products.

Call for more detailed safety information.



Solid Surface Finishing

Keep this Solid Surface Finishing Sequence Chart handy to get the best results with KLINGSPOR Abrasives every time.

FUSION FOAM (AO & SC)

- FOAM ABRASIVE WITH EXTREME LIFE AND AMAZING FINISH

FP 77 (AO)

- T-ACT COATING TO REDUCE LOADING AND IMPROVE FINISH

PS 73W (AO)

- STEARATED ALUMINUM OXIDE TO REDUCE LOADING FILM



To complete the sequences and achieve the best possible finishes, you'll need KLINGSPOR's Non-Woven Hand Pads. These premium materials are available in a variety of grits to help you reach the desired surface sheen.

** available in discs for orbital sanding*

MATTE FINISH

OPTIONAL PRE-STEP TO REMOVE SCRATCHES-P150 (PS 33 OR PS 73W)

STEP 1 P240 (PS 33, PS 73W, KLING-NET OR FUSION FOAM)

STEP 2 VERY FINE HAND PAD (WATER IMPROVES FINISH)
OR VERY FINE KLING-ON DISC

SEMI-GLOSS FINISH

OPTIONAL PRE-STEP TO REMOVE SCRATCHES-P150

STEP 1 P240 (PS 33, KLING-NET OR FUSION FOAM)

STEP 2 P400 (PS 33, FP 77, KLING-NET OR FUSION FOAM)

STEP 3 P1000 (PS 73W, FP 77, KLING-NET OR FUSION FOAM)

STEP 4 ULTRA FINE HAND PAD (OPTIONAL) OR ULTRA FINE KLING-ON DISC

HIGH GLOSS FINISH

OPTIONAL PRE-STEP TO REMOVE SCRATCHES-P150

STEP 1 P240 (PS 33, KLING-NET OR FUSION FOAM)

STEP 2 P400 (PS 33, FP 77, KLING-NET OR FUSION FOAM)

STEP 3 P1000 (FP 77, KLING-NET OR FUSION FOAM)

STEP 4 P1500 (FP 77, KLING-NET OR FUSION FOAM)

STEP 5 P2000 (FP 77 OR FUSION FOAM 1800-2500)

STEP 6 WHITE / NO ABRASIVE HAND PAD



GEM SANDER - Commonly used in solid surface finishing. Available thru Klingspor's Woodworking Shop

SUGGESTIONS FOR BEST RESULTS

1. Use a 10,000-12,000 rpm random orbital sander.
2. Start the sander while resting flat on the surface and remove the sander before stopping to eliminate swirl marks.
3. Each grit needs to pass over the surface following a "North, South, East, West" pattern (see illustration) to insure that previous scratches are removed and a uniform finish is achieved. Two passes per step is recommended.
4. Clean surface after each step to minimize contamination scratches.

Klingspor is one of the country's largest Dynabrade tool dealers. You'll find that these tools will outperform and outlast any other pneumatic tool on the market. The most popular and most useful for solid surface finishing is the Dynabrade model #56815. This random orbital sander features 12,000 rpms with a 3/16" orbit and a small hand grip. Dynabrade manufactures many tools that have perfect applications in solid surface work. Call Klingspor for all of your pneumatic tool needs.

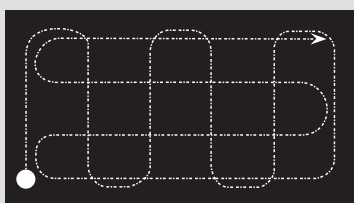

Our aluminum oxide extra-lube stearate materials (PS 73W & FP 77) are the premier products for the solid surface installer. They will accomplish tasks from removal of scratches to preparation for high gloss finishes. These materials will prove versatility and premium performance as you use it. So whether you're sanding by hand or with a power sheet sander or disc sander, these products will be your materials of choice.

AIR SUPPLY RECOMMENDATIONS FOR RO SANDERS

Sufficient air supply to portable sanding tools is crucial for proper finishing characteristics. If the air pressure is too low, random orbital disc sanders will be much more likely to create "swirl marks" or "fish hooks" on the workpiece.

KLINGSPOR recommends the following:

- Maintain steady operating air pressure of 90 P.S.I. under load. Remember this is not the same as the air pressure to the tool when it is not in use. Use your gauge on the sander to determine actual P.S.I. under load.
- Most palm style random orbital sanders require an air volume of 15 to 18 standard cubic feet per minute (SCFM). Compressor size should be a 5 hp, two stage design.
- If using rubber or plastic air hoses with an inside diameter of 3/8", a maximum length of 20 feet from the iron air supply pipe is suggested.
- Use larger I.D. hoses and couplings whenever possible. Standard hose inside diameters are typically 5/16", 3/8" and 1/2". Also, make sure the couplings' I.D. sizes are no more than one size smaller than the hose I.D. Be sure male and female couplings are of the same I.D.
- Always keep air tools properly maintained. Keep tools properly lubricated and clean. Replace worn bearings and backing pads. Keep mufflers and exhaust areas clean and unrestricted.

METAL QUICK GUIDE

FERROUS METALS

- 1.) **Cast Iron** – contains over 2% carbon, very hard & brittle
- 2.) **Carbon Steel** – is less than 2% carbon. Includes low carbon, mild/medium carbon, high carbon, tool steel. Will rust or corrode unless painted, plated or galvanized.
- 3.) **Stainless Steel** – alloyed with the metal chromium and sometimes nickel and other metals. Non-rusting or corroding. Four basic types: austenitic, martensitic, ferritic and precipitation-hardening (PH).

NON-FERROUS METALS

- 1.) **Aluminum** – very common, lightweight, strong, various hardnesses available. Used for a wide variety of applications.
- 2.) **Copper Alloys** – (pure copper, brass, bronze, copper-nickel alloys). Many types and varieties. Non-corroding.
- 3.) **Zinc** – Lightweight, white-colored metal. Mostly for die cast parts or for galvanizing steel to prevent rusting.
- 4.) **Magnesium** – Very lightweight, similar to aluminum. Usually cast.
- 5.) **Titanium** – Space age material for medical, nuclear and aerospace markets. Very lightweight, very strong.
- 6.) **Nickel and nickel alloys** – Monel is the most common nickel alloy. Similar to stainless steel. Pure nickel is usually alloyed with other metals

METAL FINISHES

Stainless Steel Mill Finishes

- #2B A mill cold-rolled finish. No abrasive used.
- #3 A 2B finish processed with #100 AO belt.
- #4 Dairy or Food Service finish. A 2B finish processed with #100 AO belts, followed by #120 AO finish or medium density non-woven.
- #6 A # 4 finish which has been buffed. A fine satin finish.
- #7 A #4 finish followed by #180 then #240 AO belts, the cut-buffed and finally color-buffed to a reflective finish. A bright finish with some grit lines still visible.
- #8 A #4 finish followed by #180, 240, 320 and 400 AO belts, followed by cut-buffing, followed by color-buffing to a mirror finish. No grit lines available. A convolute or similar wheel may be used instead of the cut/color buffing steps if acceptable.

SOFT VS HARD WHEELS

SOFT

- Shorter wheel life
- High stock removal
- Faster cut
- Large contact areas
- Less bond holding the grain together
- For use on harder metals

HARD

- Longer wheel life
- Lower stock removal
- Slower cut
- Finer finishes
- Small contact areas
- More bond holding the grain together

WHEEL THICKNESS

CUT OFF WHEELS

- 1/32" = .031"
- 3/64" = .045"
- 1/16" = .063"
- 5/64" = .078"
- 3/32" = .094"
- 1/8" = .125"
- 9/64" = .141"

GRINDING DISCS

- 1/8" = .125"
- 5/32" = .156"
- 1/4" = .250"
- 5/16" = .312"



STANDARD ALUMINUM FINISHES

M21 Smooth Specular:	Belt polished to 320 grit then buffed with Tripoli buffing compound
M22 Specular	Buffing without prior belt polishing

Directional Textured:

M31 Fine Satin Satin Satin	Belt polished to 320 then 400 grit M32 Medium Belts polished to 180 to 320 grit M33 Coarse Belt polished to 80 or 100 grit
M34 Hand Rubbed	Rubbed with medium grades of steel wool or non-woven hand pad material

Standard Finishes on Brass and Bronze

M21 Smooth Specular	Polishing to 320 grit then cut buffing with AO
M33 Specular	M21 plush light buffing
M31 Fine Satin	Polishing with AO or SC to 180 then 240
M32 Medium Satin	Polishing with AO or SC from 120 then 180
M33 Coarse Satin	Polishing with AO or SC from 80 to 120
M34 Hand Rubbed	Rubbed with medium or coarse non-woven pad
M35 Brushed	Wire brush or polish with coarse grit abrasive
M36 Uniform	Polish with 60 or 80 AO or SC

BONDED WHEEL SELECTION GUIDE

GRAIN

- A – Aluminum Oxide: for general purpose use on all metals
- C – Silicon Carbide: for use on stone and masonry applications
- Z – Alumina Zirconia: for use in aggressive cutting applications

GRIT

- 24 – Coarse: for fast cutting and maximum wheel life
- 30 – Medium/Coarse: for fast cutting and long wheel life
- 36 – Medium/Coarse: excellent for general purpose cutting
- 46 – Fine/Medium: for a smoother finish and reduced burr
- 60 – Fine: for a burr-free cut
- 80 – Fine: for a burr-free cut

GRADE

- TZ – Hard: for maximum wheel life
- R/S – Medium/Hard: for improved stock removal and life
- M/N – Soft: for maximum cut rate

DRESSING/TRUING CONVOLUTE WHEELS

Truing: To make level, balanced or concentric; bring or restore to a desired mechanical accuracy or form. To prevent vibration at high speeds, a diamond or other dressing tool is used to ensure that a non-woven grinding wheel is round and concentric.

Dressing: Removal of undesirable materials from "loaded" non-woven grinding wheels to expose unused abrasive points.

Both the above activities are limited to convolute wheels 6" in diameter and larger.

Truing or Dressing for non-woven/convolute wheels can be accomplished by either Powered Diamond Saw Blades, Coated Abrasive Materials or the use of Custom Metal Tools. The best two options of these for end users will be either the Coated Abrasive Material or the Custom Metal Tool.

The Coated Abrasive Materials option requires inexpensive material with a little technique. A piece of very coarse (24 or 36 grit) coated abrasive material and a heavy solid piece of metal is used. The coated abrasive material is used because of the many cutting points it provides for truing. The heavy piece of metal maintains contact between the non-woven wheel and the coated abrasive material. If a heavy piece of metal is not used, the coated abrasive material will bounce on and off the non-woven wheel and the wheel will not be properly trued. This method works best for the harder density non-woven wheels such as the convolute 9SF for deburring.

The Custom Metal Tool option is the most unique method of all because some operators use many different variations of "truing tools" ranging from a bottle cap to a very elaborate two-handed rake-type tooth tool. The tools are usually very thin to maintain a sharp edge, short, and have a right angle to reduce the change of snagging the tool with the wheel. This method is best suited for the softer non-woven wheels. The advantage of this method is the tool's ability to quickly cut into the wheel by actually cutting the non-woven fibers.

Profiling, which is often inaccurately referred to as "dressing", is basically putting a mirror image of the one to be sanded into the face of the sanding wheel. This procedure is not recommended for convolute wheels. There are specialty non-woven wheels made by companies like Bardo-Flex which are specifically in the weave to allow profiling.

ABRASIVE	Material	Backing	Available Grits	Properties	Jumbo Width	Coating
SILICON CARBIDE	PLAIN					
	PS11	Paper	60, 80, 100, 120, 150, 180, 220, 240, 280, 320, 400, 500, 600, 800, 1000, 1200, 1500, 2000		46	●
	PS19 E	Paper	36, 40, 50, 60, 80, 100, 120		49	d
	PS19 F	Paper	12, 16, 20, 24		49	d
	PS24 F ACT	Paper	80, 120, 150, 180, 220, 240	Antistatic	65	●
	PS24 E	Paper	280, 320, 400, 500, 600		65	●
	PS27 DW	Paper	240, 400, 600	Stearate Antistatic	57	d
	PS35 W	Paper	80, 120, 150, 180, 220, 280, 320, 400	Stearate	49	d
	CS320 Y	Polyester	24, 40, 60, 80, 100, 120, 180		61	●
	CS321 X	Cloth	80, 100, 120, 150, 180, 220, 240, 320, 400, 500, 800	Waterproof	65	●
	CS333 JF	Cloth	120, 150, 180, 240, 320		61	●
	CS538 Z ACT	Polyester	36, 40, 50, 60, 80, 100, 120, 150, 180	Antistatic	65	f
	CS539 Z ACT	Polyester	60, 80	Antistat -Coil polish	65	●
	GX533 JF	Poly blend	80, 100, 180, 240, 320, 400		61	●
		KLING-ON				
PS11 A		Paper	220, 240, 280, 320, 400, 500, 600, 800, 1000, 1200, 1500, 2000	Wet/Dry	46	●
PS11 C		Paper	60, 80, 100, 120, 150, 180	Wet/Dry	46	●
	PS35 W	Paper	80, 120, 150, 180, 220, 280, 320, 400	Stearate	49	d
	PSA					
	PS11 A	Paper	220, 240, 280, 320, 400, 500, 600, 800, 1000, 1200, 1500, 2000	Wet/Dry	46	●
	PS11 C	Paper	60, 80, 100, 120, 150, 180	Wet/Dry	46	●
	PS35 W	Paper	80, 120, 150, 180, 220, 280, 320, 400	Stearate	49	d
	CS320 Y	Polyester	40, 60		61	●
	CS321 X	Cloth	80, 100, 120, 150, 180, 220, 240	Waterproof	65	●

ABRASIVE	Material	Backing	Available Grits	Properties	Jumbo Width	Coating
CERAMIC	PLAIN					
	PS61F	Paper	60, 80, 120, 150, 180, 220, 240, 280		65	●
	CS631 XF	Cloth	60, 80, 100, 120, 280	Multibond Lube	61	●
	CS931 JF	Cloth	80, 120, 180, 240, 320	Multibond Lube	61	●
	LS912 JF	Cloth	120, 150, 180, 240, 320, 400	Multibond Lube	61	●
	CS920 Y ACT	Polyester	24, 36, 40, 50, 60, 80	Multibond Lube	61	●
	CS922 Y ACT	Polyester	36, 40, 50, 60, 80, 100, 120, 150, 180		61	●
	GX931JF	Poly blend	60, 80, 100, 120, 150	Multibond Lube	61	●
	KLING-ON					
		PS61F	Paper	60, 80, 120, 150, 180, 220, 240, 280		65



ABRASIVE	Material	Bonding agent	Waterproof	Application	Rolls	Short and long belts	Dynafle Belts	Wide belts	Strips/Sheets	Discs	
SILICON CARBIDE	PLAIN										
	PS11	R		Wood Floor Sanding	●	-	-	-	-	●	
	PS19 E	R		Wood Floor Sanding	●	-	-	-	-	●	
	PS19 F	R		Wood Floor Sanding	●	-	-	-	-	●	
	PS24 F ACT	R		Metal, Paint, Varnish, Primer, Plastic, Rubber	●	●	-	●	-	-	
	PS24 E	R		Metal, Paint, Varnish, Primer, Plastic, Rubber	●	●	-	●	-	-	
	PS27 DW	R		High Gloss Wood Finishes, UV Finishes	-	-	●	-	●	-	
	PS35 W	R		Primer, Paint, Bare Metal, Rust, Wood Finishes, Bare Wood, Epoxy	●	-	-	-	●	●	
	CS320 Y	R	✓	Glass, Plastic, Stainless Steel, Rubber, Finishes	●	●	●	●	-	-	
	CS321 X	R	✓	Glass, Plastic, Stainless Steel, Rubber, Finishes	-	●	-	●	●	●	
	CS333 JF	R		Glass, Plastic, Stainless Steel, Rubber, Finishes	●	●	-	-	●	-	
	CS538 Z ACT	R	✓	Particle Board, Plywood, MDF	-	-	-	●	-	-	
	CS539 Z ACT	R	✓	Coil Polishing, Stainless Steel	-	-	-	●	-	-	
	GX533 JF	R	✓	Non-Ferrous Metals, Paing, Varnish, Primer, PLastic, Rubber	●	●	-	-	-	-	
	KLING-ON										
	PS11 A	R	✓	Glass, Stone, Paint, Varnish, Primer, Plastics, Rubber	●	-	-	-	●	●	
	PS11 C	R	✓	Glass, Stone, Paint, Varnish, Primer, Plastics, Rubber	●	-	-	-	●	●	
	PS35 W	R		Primer, Paint, Bare Metal, Rust, Wood Finishes, Bare Wood, Epoxy	●	-	-	-	●	●	
	PSA										
PS11 A	R	✓	Glass, Stone, Paint, Varnish, Primer, Plastics, Rubber	●	-	-	-	●	●		
PS11 C	R	✓	Glass, Stone, Paint, Varnish, Primer, Plastics, Rubber	●	-	-	-	●	●		
PS35 W	R		Primer, Paint, Bare Metal, Rust, Wood Finishes, Bare Wood, Epoxy	●	-	-	-	●	●		
CS320 Y	R	✓	Glass, Plastic, Stainless Steel, Rubber, Finishes	●	●	●	●	-	-		
CS321 X	R	✓	Glass, Plastic, Stainless Steel, Rubber, Finishes	-	●	-	●	●	●		

ABRASIVE	Material	Bonding agent	Waterproof	Application	Rolls	Short and long belts	Dynafle Belts	Wide belts	Fibre Discs	Strips/Sheets	Discs
CERAMIC	PLAIN										
	PS61F	R		Steel & Stainless Steel Intermediate & Finishing	●	-	-	-	-	-	●
	CS631 XF	R		Steel, Stainless Steel, High Grinding Pressure	-	●	●	-	-	-	-
	CS931 JF	R		Steel, Stainless Steel, High Grinding Pressure	-	●	-	-	-	-	-
	LS912 JF	R		Stainless Steel, Non-Ferrous Metals, Metal	●	●	-	-	-	-	-
	CS920 Y ACT	R	✓	Steel, Stainless Steel, Cooler Grinding	-	●	●	●	-	-	-
	CS922 Y ACT	R	✓	Steel, Higher Grinding Pressure	-	●	●	●	-	-	-
	GX931JF	R	✓	Hard Steel under High Pressure	-	●	-	-	-	-	-
	KLING-ON										
	PS61F	R		Steel & Stainless Steel Intermediate & Finishing	●	-	-	-	-	-	●

ABRASIVE	Material	Backing	Available Grits	Properties	Jumbo Width	Coating
ALUMINA ZIRCONIA	PLAIN					
	PS21F	Paper	40, 60, 80, 100, 120, 150, 180, 220, 240, 280, 320, 400		65	●
	PS36 C	Paper	60, 80, 100, 120, 150, 180, 220	Stearate	49	○
	PS36 D	Paper	36, 40	Stearate	49	○
	CS409 Y	Polyester	36, 40, 50	Multibond Lube	61	●
	CS409YX	Polyester	60, 80, 100, 120	Multibond Lube	61	●
	CS411 X	Cloth	24, 36, 40, 50, 60, 80, 120		61	●
	CS411 YX	Polyester	80, 120	Light poly	61	●
	CS411 Y	Polyester	24, 36, 40, 50, 60	Med poly	61	●
	CS416 Y	Polyester	24, 36, 40, 50, 60, 80, 100, 120		61	○
	CS811 YY ACT	Polyester	24, 36, 40, 50, 60	Heavy polyester	61	●
	KLING-ON					
	PS36 C	Paper	60, 80, 100, 120, 150, 180, 220	Stearate	49	○
	PS36 D	Paper	36, 40	Stearate	49	○
	PSA					
	PS21F ACT	Paper	40, 60, 80, 100, 120, 150, 180, 220, 320, 400		65	●
	PS36 C	Paper	60, 80, 100, 120, 150, 180, 220	Stearate	49	○
	PS36 D	Paper	36, 40	Stearate	49	○
	CS409 Y	Polyester	36, 40, 60	Multibond Lube	61	●
	CS411 X	Cloth	24, 36, 40, 50, 60, 80, 120		61	●



ABRASIVE	Material	Bonding agent	Waterproof	Application	Rolls	Short and long belts	Dynaflex Belts	Wide belts	Fibre Discs	Strips/Sheets	Discs	
ALUMINA ZIRCONIA	PLAIN											
	PS21F	R		Steel, Stainless Steel, Cast Iron, Rough Wood Applications	●	●	-	●	-	-	●	
	PS36 C	R		Wood, Metal, Stainless Steel, Body Fillers	●	-	-	-	-	●	●	
	PS36 D	R		Wood, Metal, Stainless Steel, Body Fillers	●	-	-	-	-	●	●	
	CS409 Y	R	✓	Metal, Stainless Steel, Titanium (Heat Sensitive Metals)	-	●	●	●	-	-	-	
	CS409YX	R	✓	Metal, Stainless Steel, Titanium (Heat Sensitive Metals)	-	●	●	●	-	-	●*	
	CS411 X	R		Heavy Stock Removal on Carbon & Tool Steels	●	●	-	-	-	-	●	
	CS411 YX	R	✓	Heavy Stock Removal on Carbon & Tool Steels	●	●	●	●	-	-	-	
	CS411 Y	R	✓	Heavy Stock Removal on Carbon & Tool Steels	●	●	●	●	-	-	-	
	CS416 Y	R	✓	Steel, Stainless Steel, Non-Ferrous, Plastic, Leather, Wood Planing	-	●	●	●	-	-	-	
	CS811 YY ACT	R	✓	Ferrous & Non-ferrous castings, Machining Components, Forgings, Tubes, Rolls	●	●	●	●	-	-	-	
	KLING-ON											
	PS36 C	R		Glass, Stone, Paint, Varnish, Primer, Plastics, Rubber	●	-	-	-	-	●	●	
	PS36 D	R		Primer, Paint, Bare Metal, Rust, Wood Finishes, Bare Wood	●	-	-	-	-	●	●	
	PSA											
	PS21F ACT	R		Steel, Stainless Steel, Cast Iron, Rough Wood Applications	●	-	-	-	-	-	-	●
	PS36 C	R		Wood, Metal, Stainless Steel, Body Fillers	●	-	-	-	-	●	●	
	PS36 D	R		Wood, Metal, Stainless Steel, Body Fillers	●	-	-	-	-	●	●	
	CS409 Y	R	✓	Metal, Stainless Steel, Titanium (Heat Sensitive Metals)	-	-	-	-	-	-	-	
CS411 X	R		Heavy Stock Removal on Carbon & Tool Steels	●	-	-	-	-	-	●		

*12" Discs Only

ABRASIVE	Material	Backing	Available Grits	Properties	Jumbo Width	Coating
ALUMINUM OXIDE	PLAIN					
	PS10A	Paper	80, 100, 120, 150, 180, 220	Garnet	37	●
	PS10C	Paper	100, 120, 150	Garnet	37	●
	PS10D	Paper	36, 40, 50, 60, 80	Garnet	37	●
	PS20F	Paper	60, 80, 100, 120, 150, 180, 220, 240, 320, 400		65	●
	PS22F ACT	Paper	60, 80, 100, 120, 150, 180, 220, 240, 280, 320, 400	Antistatic	65	●
	PL28	Paper	60, 80, 100, 120, 150, 180, 220	Antistatic	47	●
	PS29F ACT	Paper	40, 60, 80, 100, 120, 150, 180, 220, 280, 320, 400, 500	Antistatic	65	○
	PS33 B	Paper	150, 180, 220, 240, 280, 320, 400, 500, 600	Stearate (in size coat)	49	●
	PS33 C	Paper	40, 60, 80, 100, 120, 150, 180, 240, 320, 400,	Stearate (in size coat)	49	●
	VP73 CW	Latex	80, 100, 120, 150, 180, 220, 320, 400, 600, 800, 1000, 1200, 1500	Stearate	49	●
	PS77 C	Paper	60, 80, 100, 120, 150, 180, 220	T-ACT	49	●
	FP77	Film 3-mil	80, 100, 120, 150, 180, 220, 320, 400, 500, 600, 800, 1000, 1200, 1500, 2000	T-ACT	49	●
	CS308 YX	Cloth/poly	40, 60, 80, 100, 120, 150, 180, 240		61	●
	LS 309 JF	Cloth	60, 80, 100, 120, 150, 180, 220, 240, 280, 320, 360, 400, 600		61	
	LS 309 J	Cloth	60, 80, 100, 120, 150, 180, 220, 240, 280, 320, 360, 400, 500		61	
	LS 309 XH	Cloth	40, 50, 60, 80, 100, 120, 150	Portable Belts Only	49	
	CS310 XF	Cloth	40, 50, 60, 80, 100, 120, 150, 180, 220, 240	Dynafile	61	●
	CS310 X	Cloth	24, 36, 40, 50, 60, 80, 100, 120, 150, 180, 220, 240, 320, 400, 600		61	●
	CS311 YX ACT	Cloth/Poly	40, 50, 60, 80, 100, 120, 150, 180, 220	Antistatic	61	○
	CS311 Y ACT	Polyester	36	Antistatic	61	○
	LS312 JF	Cloth	60, 80, 100, 120, 150, 180, 220, 240, 280, 320, 400	Multibond Lube	61	●
	LS313 JF	Cloth	80, 120, 150, 180, 320	Multibond Lube	61	●
	LS318 JF ACT	Cloth	100, 120, 150, 180		61	○
	CS326 YX	Polyester	60, 80, 120, 180, 240, 320, 600	Agglomerate	61	●
	CS341 X	Cloth	60, 80, 100, 120, 150, 180, 220, 240, 280, 320, 400, 500, 600		65	●
	KL361 JF	Cloth	30, 40, 50, 60, 80, 100, 120, 150, 180, 220, 240, 280, 320, 400, 500, 600	Shop Roll (Yds)	49	●
	CS412 YX	Polyester	40, 50, 60, 80, 100, 120, 150, 180, 240	Light poly	61	●
	CS412 Y	Polyester	24, 36	Med poly	61	●
	CS710 XF	Cloth	80, 100, 120, 150, 180, 240	Heat Treated	61	●
	GX712JF	Poly blend	80, 100, 220, 240, 280, 320, 400	Multibond Lube	61	●
	CS322 X	Cloth	No Grit	Cork Material	65	●



ABRASIVE	Material	Bonding agent	Waterproof	Application	Rolls	Short and long belts	Dynafile Belts	Wide belts	Fibre Discs	Strips/Sheets	Discs	
ALUMINUM OXIDE	PLAIN											
	PS10A	G		Wood, Finishes	-	-	-	-	-	●	-	
	PS10C	G		Wood, Finishes	-	-	-	-	-	●	-	
	PS10D	G		Wood, Finishes	-	-	-	-	-	●	-	
	PS20F	R		Metal, Wood, Leather	●	●	-	●	-	-	-	
	PS22F ACT	R		Metal, Hardwoods, Leather, MDF (Finishing grits)	●	●	-	●	-	-	●	
	PL28	R		Metal, Wood, Solid Surface	-	-	-	-	-	-	●	
	PS29F ACT	R		Softwood, Mix of Hard & Soft	●	●	-	●	-	-	●	
	PS33 B	R		Metal, Fiberglass, Paint/Varnish/Primer, Wood, Plastic, Rubber	●	-	-	-	-	●	●	
	PS33 C	R		Metal, Fiberglass, Paint/Varnish/Primer, Wood, Plastic, Rubber	●	-	-	-	-	●	●	
	VP73 CW	R		Metal, Fiberglass, Paint/Varnish/Primer, Wood, Plastic, Rubber	●	-	-	-	-	●	●	
	PS77 C	R		Metal, Fiberglass, Paint/Varnish/Primer, Wood, Plastic, Rubber	●	-	-	-	-	●	●	
	FP77	R	✓	Metal, Fiberglass, Paint/Varnish/Primer, Wood, Plastic, Rubber	●	-	-	-	-	●	●	
	CS308 YX	R		Ferrous & Non-ferrous Metals, Hardwoods	●	-	-	-	-	●	●	
	LS 309 JF			Ferrous & Non-ferrous Metals, Hardwoods	●	●	●	●	-	-	-	
	LS 309 J			Ferrous & Non-ferrous Metals, Hardwoods	-	●	●	●	-	-	-	
	LS 309 XH			Ferrous & Non-ferrous Metals, Hardwoods	-	●	-	-	-	-	●	
	CS310 XF	R		Ferrous Metals, Hardwoods, Leather, Aluminum, Stainless Steel, MDF	-	-	-	-	-	-	-	
	CS310 X	R		Ferrous Metals, Hardwoods, Leather, Aluminum, Stainless Steel	●	●	-	-	-	●	●	
	CS311 YX ACT	R		Softwood, Mix of Hard & Soft	●	●	-	-	-	●	●	
	CS311 Y ACT	R	✓	Softwood, Mix of Hard & Soft	●	●	-	-	-	-	-	
	LS312 JF	R		Polishing Ferrous & Non-ferrous Metals, Wood	●	●	-	-	-	-	-	
	LS313 JF	R		Stainless Steel, Aluminum, Titanium, Wood	●	●	-	-	-	-	-	
	LS318 JF ACT	R		Softwood	-	●	-	-	-	-	-	
	CS326 YX	R	✓	Metal Grinding, Polishing, Centerless or Roll Grinding	-	●	-	●	-	-	-	
	CS341 X	R	✓	Metal Grinding & Polishing w/ Water or Oil Coolants	-	●	-	●	-	-	-	
	KL361 JF	R		General Purpose Metal or Wood	●	-	-	-	-	●	-	
	CS412 YX	R	✓	Ferrous & Non-ferrous Metals, Hardwoods	●	●	●	●	-	-	-	
	CS412 Y	R	✓	Ferrous & Non-ferrous Metals, Hardwoods	●	●	●	●	-	-	-	
	CS710 XF	R		Ferrous Metals, Hardwoods	●	●	●	-	-	-	●	
	GX712JF	R	✓	Better Finishes on Ferrous & Non-ferrous Metals	●	●	-	-	-	-	-	
	CS322 X		✓	Polishing glass and stone	-	●	●	●	-	-	-	

ABRASIVE	Material	Backing	Available Grits	Properties	Jumbo Width	Coating
ALUMINUM OXIDE	KLING-ON					
	PL28	Paper	60, 80, 100, 120, 150, 180, 220	Antistatic	47	●
	PS29F ACT	Paper	40, 60, 80, 100, 120, 150, 180, 220, 320, 400	Antistatic	65	○
	PS33 B	Paper	150, 180, 220, 240, 280, 320, 400, 500, 600	Stearate (in size coat)	49	●
	PS33 C	Paper	40, 60, 80, 100, 120	Stearate (in size coat)	49	●
	VP73 CW	Latex	80, 100, 120, 150, 180, 220, 240, 320, 400, 600, 800, 1000, 1200	Stearate	49	●
	PS77 C	Paper C	60, 80, 100, 120, 150, 180, 220	T-ACT	49	●
	FP77	Film 3-mil	80, 100, 120, 150, 180, 220, 320, 400, 500, 600, 800, 1000, 1200, 1500, 2000	T-ACT	49	●
	CS310 X	Cloth	24, 36, 40, 50, 60, 80		61	●
	CS710 XF	Cloth	80, 100, 120, 150, 180, 240	Heat Treated	61	●
	KLINGNET	Net/Mesh	80, 100, 120, 150, 180, 220, 240, 280, 320, 400, 600, 800	Dust Extraction	46	○
	PSA					
	PS29F ACT	Paper	40, 60, 80, 100, 120, 150, 180, 220, 240, 280, 320, 400	Antistatic	65	●
	PS33 B	Paper	150, 180, 220, 240, 280, 320, 400, 500, 600	Stearate (in size coat)	49	●
	PS33 C	Paper	40, 60, 80, 100, 120	Stearate (in size coat)	49	●
	VP73 CW	Latex	80, 100, 120, 150, 180, 220, 240, 320, 400, 600, 800, 1000, 1200	Stearate	49	○
	PS77 C	Paper C	60, 80, 100, 120, 150, 180, 220	T-ACT	49	●
	FP77	Film 3-mil	80, 100, 120, 150, 180, 220, 320, 400, 500, 600, 800, 1000, 1200, 1500, 2000	T-ACT	49	●
	LS 309 J	Cloth	80, 100, 120, 150, 180, 220		61	
	CS310 X	Cloth	80, 100, 120, 150, 180, 220, 240, 320, 400, 600		61	●
CS311 YX ACT	Cloth/Poly	40, 50, 60, 80, 100, 120, 150, 180	Antistatic	61	●	
CS311 Y ACT	Polyester	36	Antistatic	61	●	
LS312 JF	Cloth	120, 150, 180, 220	Multibond Lube	61	●	



ABRASIVE	Material	Bonding agent	Waterproof	Application	Rolls	Short and long belts	Dynaflex Belts	Wide belts	Fibre Discs	Strips/Sheets	Discs	
ALUMINUM OXIDE	KLING-ON											
	PL28	R		Metal, Wood, Solid Surface	-	-	-	-	-	-	●	
	PS29F ACT	R		Softwood, Mix of Hard & Soft	●	-	-	-	-	-	●	
	PS33 B	R		Metal, Fiberglass, Paint/Varnish/Primer, Wood, Plastic, Rubber	●	-	-	-	-	●	●	
	PS33 C	R		Metal, Fiberglass, Paint/Varnish/Primer, Wood, Plastic, Rubber	●	-	-	-	-	●	●	
	VP73 CW	R		Metal, Fiberglass, Paint/Varnish/Primer, Wood, Plastic, Rubber	●	-	-	-	-	●	●	
	PS77 C	R		Metal, Fiberglass, Paint/Varnish/Primer, Wood, Plastic, Rubber	●	-	-	-	-	●	●	
	FP77	R	✓	Metal, Fiberglass, Paint/Varnish/Primer, Wood, Plastic, Rubber	●	-	-	-	-	●	●	
	CS310 X	R		Ferrous Metals, Hardwoods, Leather, Aluminum, Stainless Steel	●	-	-	-	-	-	●	
	CS710 XF	R		Ferrous Metals, Hardwoods	●	-	-	-	-	-	●	
	KLINGNET	R	✓	Wood, Wood Finishes, Metals, Fiberglass, Plastics: Dust Extraction	-	-	-	-	-	●	●	
	PSA											
	PS29F ACT	R		Softwood, Mix of Hard & Soft	●	-	-	-	-	-	-	●
	PS33 B	R		Metal, Fiberglass, Paint/Varnish/Primer, Wood, Plastic, Rubber	●	-	-	-	-	-	●	●
	PS33 C	R		Metal, Fiberglass, Paint/Varnish/Primer, Wood, Plastic, Rubber	●	-	-	-	-	-	●	●
	VP73 CW	R		Metal, Fiberglass, Paint/Varnish/Primer, Wood, Plastic, Rubber	●	-	-	-	-	-	●	●
	PS77 C	R		Metal, Fiberglass, Paint/Varnish/Primer, Wood, Plastic, Rubber	●	-	-	-	-	-	●	●
	FP77	R	✓	Metal, Fiberglass, Paint/Varnish/Primer, Wood, Plastic, Rubber	●	-	-	-	-	-	●	●
	LS 309 J			Ferrous & Non-ferrous Metals, Hardwoods	●	-	-	-	-	-	-	●
	CS310 X	R		Ferrous Metals, Hardwoods, Leather, Aluminum, Stainless Steel	●	-	-	-	-	-	-	●
CS311 YX ACT	R		Softwood, Mix of Hard & Soft	●	-	-	-	-	-	-	●	
CS311 Y ACT	R	✓	Softwood, Mix of Hard & Soft	●	-	-	-	-	-	-	●	
LS312 JF	R		Polishing Ferrous & Non-ferrous Metals, Wood (Heat Sensitive Metals)	●	-	-	-	-	-	-	●	



KLINGSPOR

The Most Sounding Power for Your Money Since 1893!

2555 Tate Boulevard, S.E.,
PO Box 2367
Hickory, North Carolina 28603-2367

Toll Free 800-645-5555

Corporate 828-322-3030

Toll Free Fax 800-524-6758

www.klingspor.com