



Light is motion Light range 2024

Insist on OSRAM – the No. 1 in Automotive Lighting

Insist on OSRAM

OSRAM

Quite simply the best solution



INTERNATIONAL
PORTFOLIO¹⁾

OSRAM offers the perfect vehicle lamp for every application and need, whether for cars, motorcycles, trucks, or off-road vehicles. Whether you prefer LED, xenon, or halogen, our products meet the demands of both performance-focused and design-conscious drivers. We're taking it a step further with a range of products designed to keep you moving, no matter what challenges lie ahead. From tire care to battery maintenance and more, our automotive care and equipment portfolio will ensure you're well-prepared for every journey.

LED On-Road²⁾ Lamps	4
NIGHT BREAKER® LED Headlights	8
NIGHT BREAKER® LED Signal Lights	12
TRUCKSTAR® LED Headlights	14
LEDiving® Accessories	16
LED On-Road Lamps – Measurements	24
LED Off-Road³⁾ Lamps	26
LEDiving® HL	28
LEDiving® SL	32
LEDiving® HLM	34
LEDiving® Accessories	36
LED Off-Road Lamps – Measurements	40
Xenon Headlight Lamps	44
XENARC® NIGHT BREAKER® 220	46
XENARC® COOL BLUE® INTENSE	48
XENARC® COOL BLUE® BOOST ³⁾	50
XENARC® ULTRA LIFE	52
XENARC® ORIGINAL	54
Xenon Headlight Lamps – Measurements	57
Halogen Lamps	58
NIGHT BREAKER® 220	62
NIGHT BREAKER® LASER	64
NIGHT BREAKER® SILVER	66
COOL BLUE® INTENSE	68
DIADEM® CHROME	70
ULTRA LIFE	72
ORIGINAL 12 V	74
MINIBOX	78
ORIGINAL MOTORCYCLE	80
SUPER BRIGHT ³⁾ / SUPER BRIGHT PREMIUM ³⁾	82
COOL BLUE® BOOST ³⁾	84
Halogen Lamps – Measurements	86
Automotive Care & Equipment	88
Inspection lights	90
Tyre care	98
Battery care	106
Power inverters	121
Warning, safety and reading lights	124

LED Driving Lights	130
Multifunctional series	132
Functional series	135
Slim series	139
Value series	142
Accessories	147
LED Driving Lights – Measurements & Patterns	155
LED Working Lights	160
Professional series	162
Value series	168
Multifunctional series	172
Functional series	174
Accessories	176
LED Working Lights – Measurements & Patterns	181
LED Fixtures	186
LEDiving® Headlights	188
LEDiving® Dynamic Mirror Indicators	191
LEDiving® Tail Lights	193
LED Fixtures – Measurements	195
Bicycle lighting, care, and equipment	196
LEDsBIKE® lights	199
Road-ready care and equipment	202
Professional Automotive Care & Equipment	204
Inspection lights	206
Battery care	214
Power inverters	220
Warning and safety lights	226

1) Please note: This catalogue contains an international portfolio. Several countries do not allow sale and use of non-ECE approved products. Please contact your local distributor for information on the availability in your country.
2) Approved LED light source – only applies to the respective countries in which there is approval or to which an equivalent approval applies, and the vehicle models and light functions currently listed in the compatibility list.
For more details see www.osram.com/nb-led. 3) These products do not have ECE approval and must not be used on public roads in any exterior application. Public roads use leads to cancellation of operating license and loss of insurance coverage. Several countries forbid sale and use of these products. Please contact your local distributor for further information.



1) Approved LED light source – only applies to the respective countries in which there is approval or to which an equivalent approval applies, and the vehicle models and light functions currently listed in the compatibility list. For more details see www.osram.com/nb-led.

LED On-Road¹⁾ Lamps

Superior brightness for wherever the road takes you



OSRAM-quality guaranteed

All OSRAM products are extensively stress tested by our quality assurance system. For information concerning guarantees, visit www.osram.com/am-guarantee or scan the QR code.

1

NIGHT BREAKER® LED Headlights

Switch easily from halogen to street-legal¹⁾ LED light. An innovation and revolution from OSRAM in the field of technology and design.



2

NIGHT BREAKER® LED Signal Lights

Upgrade your vehicle with perfectly tailored and designed LED lamps – for exterior and interior applications.¹⁾



3

TRUCKSTAR® LED Headlights

With the TRUCKSTAR® H7 LED, OSRAM's first street-legal¹⁾ H7 LED retrofit lamp for 24 V vehicles is on the market.



4

LEDiving® Accessories

Enjoy full benefits of your LED upgrade by replacing your conventional lamps with the help of OSRAM LEDiving® Accessories.



1) Approved LED light source – only applies to the respective countries in which there is approval or to which an equivalent approval applies, and the vehicle models and light functions currently listed in the compatibility list. For more details see www.osram.com/nb-led.

The road to regulatory freedom

In 2020, the first NIGHT BREAKER® LED lamps were granted street-legal¹⁾ approval status by the German Federal Motor Transport Authority, after extensive photometric, mechanical and electrical testing in collaboration with TÜV SÜD. Since then, a growing number of countries have granted approval.



Check compatibility



The list of approved countries can be found at www.osram.com/nb-led

Invest in your success









Offering a street-legal¹⁾ LED upgrade to your customers is a sure way to build loyalty and improve sales. In this guide, we'll show you how to check compatibility and ensure legal compliance when installing NIGHT BREAKER® LED replacement lamps.

1) Approved LED light source – only applies to the respective countries in which there is approval or to which an equivalent approval applies, and the vehicle models and light functions currently listed in the compatibility list. For more details see www.osram.com/nb-led.

LED upgrades benefit your customers

The superior performance of LED technology makes it an attractive upgrade option for every customer.



 <p>Enhanced safety See further, react sooner with up to 330%¹⁾ brighter light and high contrast.</p>	 <p>Better vision and visibility Optimised light distribution, reduced glare³⁾, far-reaching beams and a modern look for the vehicle.</p>
 <p>Driving comfort Cool-white colour (up to 6 000 K) creates day-like conditions.</p>	 <p>Exceptional long service life Up to 6 times more lifetime with up to 6-year guarantee.²⁾</p>
 <p>Long-lasting brightness Maintains constant lumen value over the entire service life.</p>	 <p>Fewer burn outs High surge protection for voltage peaks.</p>
 <p>Energy efficiency Reduced energy consumption of LED technology can lead to an increase in the efficiency of the vehicle.³⁾</p>	 <p>Wide compatibility Approved for a wide range of vehicles from cars to campers and everything in between.⁴⁾</p>

1) In comparison to the minimum requirements of ECE R112, while the glare is below the maximum permissible values by up to 50%. 2) For precise conditions please refer to www.osram.com/am-guarantee. 3) Compared to conventional lamps. 4) Approved LED light source – only applies to the respective countries in which there is approval or to which an equivalent approval applies and the vehicle models and light functions currently listed in the compatibility list. For more details see www.osram.com/nb-led.



Street-legal:¹⁾

The NIGHT BREAKER® LED family – OSRAM's first street-legal¹⁾ LED retrofit lamps.

1 NIGHT BREAKER® LED Headlights

Switch easily and legally¹⁾ from halogen to LED light

Further developed, optimized and redesigned by OSRAM – The new NIGHT BREAKER® LED retrofit lamps. They impress with an improved optical design that enables higher luminance and can therefore achieve optimized illumination. Additionally with a revised, innovative and compact design for a more modern look and are characterized by more efficient thermal management, which can lead to a lower heat load. With OSRAM's street-legal¹⁾ retrofit lamps, you can benefit from highly energy-efficient, bright and modern LED light. You can now upgrade the function of your high- and low beam lights of the vehicle to state-of-the-art LED technology.

Up to 330% more brightness²⁾ & 6 000 K:
See and be seen with OSRAM. Cool white color temperature similar to daylight. See further, react sooner, especially when driving at night.

Up to 6x longer lifetime:³⁾
Cost efficient, vibration resistant and environmentally friendly.

Guarantee:⁴⁾
Systematic quality assurance measures underpin the premium workmanship and functionality. Innovative technology and excellent quality really pay dividends for customers.

NIGHT BREAKER® LED SPEED H7



Especially developed for customer and market needs. Quickly installed, easily installed with the latest innovative OSRAM electronics inside. A mechanical compatibility inspired by traditional lamps, with all the added features and benefits of OSRAM's street-legal¹⁾ LED lamps.

Features

- 1:1 Design
- Fast & Easy installation
- 6 000 K & Cool white color temperature
- Integrated active cooling
- Innovative electronic
- Universal Polarity
- Up to 60% less energy consumption²⁾
- Up to 50% less glare³⁾
- 5+1-year OSRAM Guarantee⁴⁾

Benefits

- Dimensions & Mechanical compatibility inspired by traditional lamps
- No adapter and no caps needed
- No flickering & No failure message during cold lamp test
- Color temperature close to daylight
- Environmentally friendly and cost efficient through longer durability
- Innovative technology and excellent quality
- Better vision and visibility

NIGHT BREAKER® LED SPEED

Product Reference	EAN	Icon	ECE	W	V	K	COLOR	lm	Icon	Icon	GUARANTEE (YEAR)
64210DWNBSP-2HB	4062172411264	PX26D	H7-LED	16	12	6000	White	1550	2	4	5+1
64210DWNBSP	4062172411295	PX26D	H7-LED	16	12	6000	White	1550	2	4	5+1
64210DWNBSP-1HB	4062172411325	PX26D	H7-LED	16	12	6000	White	1550	1	2	5+1

NIGHT BREAKER® LED SMART H4 & H7



Exceptionally bright, innovatively compact, widely applicable, broadly compatible, particularly durable and of course street legal.¹⁾ The NIGHT BREAKER® LED SMART. A smart and clever solution from OSRAM.

Features

- Up to 330% more brightness³⁾ & Up to 6 000 K
- Compact Design & Up to 6 - times more lifetime²⁾
- Easy installation & 5+1 year OSRAM Guarantee⁴⁾
- Up to 60% less energy consumption²⁾
- Up to 50% less glare³⁾

Benefits

- Cool White LED-Upgrade with color temperature close to daylight
- Environmentally friendly and cost efficient through longer durability
- Innovative technology and excellent quality really pay dividends for our customers
- Benefit from better vision and visibility and at the same time, reduced glare of all other road users

NIGHT BREAKER® LED

Product Reference	EAN	Icon	ECE	W	V	K	COLOR	lm	Icon	Icon	GUARANTEE (YEAR)
NIGHT BREAKER® LED SMART											
64193DWNBSM-2HB	4062172398138	P43T	H4-LED	20/19	12	6000	White	1650/1000	2	4	5
64193DWNBSM	4062172398152	P43T	H4-LED	20/19	12	6000	White	1650/1000	2	4	5+1
64210DWNBSM-2HB	4062172408332	PX26D	H7-LED	16	12	6000	White	1550	2	4	5
64210DWNBSM	4062172408370	PX26D	H7-LED	16	12	6000	White	1550	2	4	5+1

NIGHT BREAKER® LED SMART MOTORCYCLE

64193DWNBSM-1HB	4062172398114	P43T	H4-LED	20/19	12	6000	White	1650/1000	1	4	5+1
-----------------	---------------	------	--------	-------	----	------	-------	-----------	---	---	-----

¹⁾ Approved LED light source – only applies to the respective countries in which there is approval or to which an equivalent approval applies, and the vehicle models and light functions currently listed in the compatibility list. For more details see www.osram.com/nb-led. ²⁾ In comparison to the minimum requirements of ECE R112, while the glare is below the maximum permissible values by up to 50%. ³⁾ In comparison to traditional halogen lamps. ⁴⁾ For precise conditions please refer to www.osram.com/am-guarantee.

¹⁾ Approved LED light source – only applies to the respective countries in which there is approval or to which an equivalent approval applies, and the vehicle models and light functions currently listed in the compatibility list. For more details see www.osram.com/nb-led. ²⁾ In comparison to the minimum requirements of ECE R112, while the glare is below the maximum permissible values by up to 50%. ³⁾ In comparison to traditional halogen lamps. ⁴⁾ For precise conditions please refer to www.osram.com/am-guarantee.

NIGHT BREAKER® LED GEN 2 H7

For a wide range of headlights and vehicle types, with the NIGHT BREAKER® LED GEN 2, you can now experience the superior performance of state-of-the-art lighting technology in your vehicle.



Features

- Up to 230% more brightness¹⁾ & up to 6 000 K
- Up to 5 - times more lifetime²⁾
- 4+1 year OSRAM Guarantee³⁾
- Up to 60% less energy consumption²⁾
- Up to 50% less glare¹⁾

Benefits

- Cool White LED-Upgrade with color temperature close to daylight
- Environmentally friendly and cost efficient through longer durability
- Innovative technology and excellent quality really pay dividends for our customers
- Benefit from better vision and visibility and at the same time, reduced glare of all other road users

NIGHT BREAKER® LED

Product Reference	EAN									
-------------------	-----	--	--	--	--	--	--	--	--	--

NIGHT BREAKER® LED GEN 2

64210DWNBG2-2HFB	4062172369244	PX26D	H7-LED	16	12	6000	White	1500	2	4	4
64210DWNBG2	4062172369268	PX26D	H7-LED	16	12	6000	White	1500	2	4	4+1

NIGHT BREAKER® LED GEN 2 MOTORCYCLE

64210DWNBG2-1HB	4062172383301	PX26D	H7-LED	16	12	6000	White	1500	1	4	4+1
-----------------	---------------	-------	--------	----	----	------	-------	------	---	---	-----

NIGHT BREAKER® LED H1

Benefit from better vision and visibility and at the same time, reduced glare of all other road users.



Features

- Cool white color temperature & Up to 6 000 K
- Up to 5 - times more lifetime²⁾
- 4+1 year OSRAM Guarantee³⁾
- Up to 40% less energy consumption²⁾
- Up to 50% less glare¹⁾

Benefits

- Easy installation Easy plug in for different connector types
- Environmentally friendly and cost efficient through longer durability
- Cool White LED-Upgrade with color temperature close to daylight
- Benefit from better vision and visibility and at the same time, reduced glare of all other road user

NIGHT BREAKER® LED

Product Reference	EAN									
-------------------	-----	--	--	--	--	--	--	--	--	--

64150DWNB-2HFB	4062172373791	P14.5s	H1-LED	16	12	6000	White	1550	2	4	4+1
----------------	---------------	--------	--------	----	----	------	-------	------	---	---	-----

1) In comparison to the minimum requirements of ECE R112, while the glare is below the maximum permissible values by up to 50%. 2) In comparison to traditional halogen lamps. 3) For precise conditions please refer to www.osram.com/am-guarantee.

Bringing brighter light to campervan owners

Campervan owners spend a lot of time on the road, often driving long distances at night on unfamiliar roads without any streetlights. Having a clear view of the road ahead at all times is therefore a top priority. With up superior brightness the NIGHT BREAKER® LED for campervans¹⁾ is the easiest way to upgrade your driving performance.

These energy-efficient LED replacement lamps produce powerful beams that illuminate the road with day-like clarity – allowing you to see further, spot signs and obstacles earlier, and avoid danger.

Optimised light distribution, glare reduction technology, and the cool white colour temperature of 6 000 K makes driving at night more comfortable. And with up to 60% lower energy consumption, you're far less likely to drain your battery or experience a blowout.

In fact, the NIGHT BREAKER® LED for campervans lasts up to 6 times longer than standard halogen lamps. This means fewer trips to the garage for maintenance and more peace of mind when you're behind the wheel.

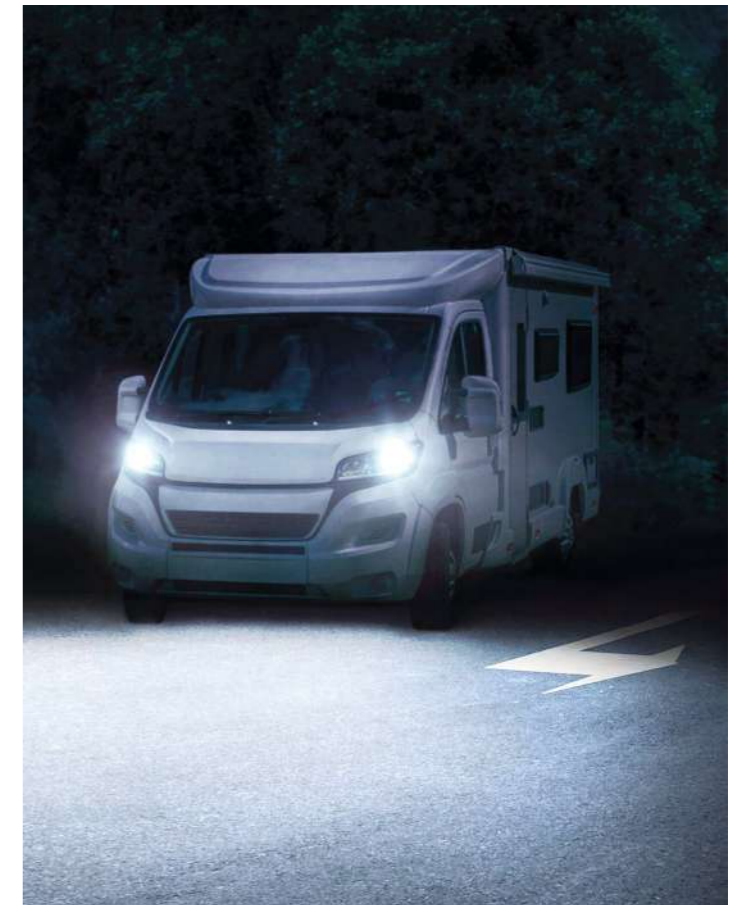

Bringing brighter light to motorbike owners

With the street-legal NIGHT BREAKER® LEDs, you can also upgrade the function of your high and low beam lights on your motorbike to state-of-the-art LED technology.

See and be seen on your Motorbike with OSRAM, for more safety on the road, especially when driving at night. Cool white color temperature similar to daylight and with the special developed vibration resistant design you can now replace your motorbike lamps with OSRAM's revolutionary NIGHT BREAKER® LED retrofit lamps and experience trend-setting brightness with road approval.²⁾



1) In comparison to the minimum requirements of ECE R112, while the glare is below the maximum permissible values by up to 50%. 2) Approved LED light source – only applies to the respective countries in which there is approval or to which an equivalent approval applies, and the vehicle models and light functions currently listed in the compatibility list. For more details see www.osram.com/nb-led.



STREET LEGAL

Street-legal:¹⁾

The NIGHT BREAKER® LED family – OSRAM's first street-legal¹⁾ LED retrofit lamps.

2 NIGHT BREAKER® LED Signal Lights

Switch easily and legally¹⁾ from halogen to LED light

With the NIGHT BREAKER® W5W-LED, OSRAM's first street legal¹⁾ W5W-LED replacement lamp is now on the market, which is approved for use in all¹⁾ 12 V vehicle models behind white glass as a parking light, position light, marker light, license plate light and interior light. This is the first lamp from OSRAM does not require to compare and match the headlamp approval number with a compatibility list. In combination with the NIGHT BREAKER® LED headlights you can now get the full LED upgrade for your vehicle with perfectly tailored and designed LED lamps – for exterior and interior applications.



Universal Polarity:

Installation independent of polarity possible. Quick and easy upgrade to LED technology with Plug & Play solution.



Up to 5x longer lifetime:²⁾

Cost efficient, vibration resistant and environmentally friendly.



Guarantee:³⁾

Systematic quality assurance measures underpin the premium workmanship and functionality. Innovative technology and excellent quality really pay dividends for customers.

NIGHT BREAKER® LED W5W



This is the first street-legal¹⁾ LED replacement lamp from OSRAM that does not require to compare and match the headlamp approval number with a compatibility list.

Features

- Up to 5 700 K & up to 50 lm
- Up to 5 – times more lifetime²⁾
- 4+1 year OSRAM Guarantee³⁾
- Up to 40% less energy consumption¹⁾
- Plug & Play Universal Polarity

Benefits

- Optimized light output for the designated area of application
- For interior and exterior application
- Cool White LED-Upgrade with color temperature close to daylight
- Installation independent of polarity possible
- Optional suitable accessory for installation available

NIGHT BREAKER® LED W5W

Product Reference	EAN		ECE	W	V	K	COLOR	lm			GUARANTEE (YEAR)
2825DWNB-2HFB	4062172367424	W2.1x9.5d	W5W-LED	1	12	5700	White	50	2	10	4+1



¹⁾ Approved LED light source – only applies to the respective countries in which there is approval or to which an equivalent approval applies, and the vehicle models and light functions currently listed in the compatibility list. For more details see www.osram.com/nb-led. ²⁾ In comparison to traditional halogen lamps. ³⁾ For precise conditions please refer to www.osram.com/am-guarantee.

¹⁾ Approved LED light source – only applies to the respective countries in which there is approval or to which an equivalent approval applies, and the vehicle models and light functions currently listed in the compatibility list. For more details see www.osram.com/nb-led. ²⁾ In comparison to traditional halogen lamps. ³⁾ For precise conditions please refer to www.osram.com/am-guarantee.



Street-legal:¹⁾

The TRUCKSTAR® LED – OSRAM's first street-legal¹⁾ LED retrofit lamps for 24 V Vehicles.

3 TRUCKSTAR® LED Headlights

Switch easily and legally¹⁾ from halogen to LED light

For truck drivers, fleet managers and freight forwarders. For trucks, special vehicles, buses and towing vehicles. For nearly everyone in the „heavy duty“ sector and beyond. With the street-legal¹⁾ TRUCKSTAR® H7-LED for 24 V Vehicles you can now upgrade the function of your high- and low beam lights of your vehicle to state-of-the-art LED technology. Especially engineered for the 24 V and "heavy duty" range.



Heavy Duty Application: Specially developed vibration-resistant design, engineered for the 24 V and "heavy duty" range for an up to 5 times longer lifetime.²⁾



Up to 230% more brightness³⁾ & 6 000 K. See and be seen with OSRAM. Cool white color temperature similar to daylight. See further, react sooner, especially when driving at night.



Guarantee:⁴⁾ Systematic quality assurance measures underpin the premium workmanship and functionality. Innovative technology and excellent quality really pay dividends for customers.

TRUCKSTAR® LED H7



For truck drivers, fleet managers and freight forwarders. For trucks, special vehicles, buses, and towing vehicles. For nearly everyone in the "heavy duty" sector and beyond.

Features

- Vibration resistant
- For Heavy Duty application
- 4+1 year OSRAM Guarantee¹⁾ even in commercial use
- Up to 75% less energy consumption²⁾
- Up to 50% less glare³⁾

Benefits

- Cool White LED-Upgrade with color temperature close to daylight
- Environmentally friendly and cost efficient through longer durability
- Innovative technology and excellent quality really pay dividends for our customers
- Benefit from better vision and visibility and at the same time, reduced glare of all other road users

TRUCKSTAR® LED

Product Reference	EAN		ECE	W	V	K	COLOR	lm			GUARANTEE (YEAR)
64215DWTS-2HFB	4062172384919	PX26D	H7-LED	16	24	6000	White	1500	2	4	4+1



1) Approved LED light source - only applies to the respective countries in which there is approval or to which an equivalent approval applies, and the vehicle models and light functions currently listed in the compatibility list. For more details see www.osram.com/nb-led. 2) In comparison to traditional halogen lamps. 3) In comparison to the minimum requirements of ECE R112, while the glare is below the maximum permissible values by up to 50%. 4) For precise conditions please refer to www.osram.com/am-guarantee.

1) For precise conditions please refer to www.osram.com/am-guarantee. 2) In comparison to traditional halogen lamps. 3) In comparison to the minimum requirements of ECE R112, while the glare is below the maximum permissible values by up to 50%.



Easy installation:

A wide range of accessories offered by OSRAM for an easy installation and compatibility. For error-free or even flicker-free operation of LED lamps.

4 LEDriving® Accessories

Easy upgrade, essential benefits

Convert from halogen to LED with original OSRAM accessories: LEDriving® ADAPTER, LEDriving® SMART CANBUS, LEDriving® CAP's and LEDriving® ERROR CANCELER that make the installation easy and error message free.¹⁾



Robust and resistant:
For a durable application.



Error message free:
Potential error messages on vehicle dashboards are avoided.



Guarantee:²⁾
Systematic quality assurance measures underpin the premium workmanship and functionality. Innovative technology and excellent quality really pay dividends for customers.

1) Only the combination of OSRAM LED lamps in conjunction with the official OSRAM accessories – LEDriving® ADAPTER, LEDriving® SMART CANBUS, LEDriving® CAP's and LEDriving® ERROR CANCELER is approved for the operation of our LED lamps. 2) For precise conditions please refer to www.osram.com/am-guarantee.

Compatibility and compliance

OSRAM's family of street-legal¹⁾ LED replacement lamps gives more motorists the opportunity to upgrade their vision. This can be achieved with lamps alone or in combination with OSRAM accessories²⁾ – depending on the vehicle model.

Ensure a secure fit in different headlight sockets.



LEDriving® CAP



LEDriving® ADAPTER

Prevents false error messages in the dashboard.



LEDriving® SMART CANBUS



LEDriving® ERROR CANCELER

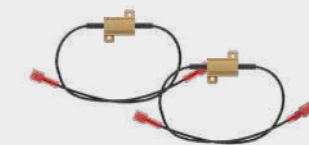

LEDriving® CANBUS CONTROL UNIT

How to find out if your customer's vehicle is compatible:



Scan the QR code on the packaging or go to www.osram.com/nb-led.



Look for their car model, the headlight approval number and year of manufacture in the list of compatible vehicles.



Check which accessories you need (if required).

1) Approved LED light source - only applies to the respective countries in which there is approval or to which an equivalent approval applies, and the vehicle models and light functions currently listed in the compatibility list. For more details see www.osram.com/nb-led. 2) Where the use of accessories is instructed, only the combination of OSRAM NIGHT BREAKER® LED lamps and official OSRAM accessories are covered by the approval. For precise conditions please refer to www.osram.com/am-guarantee.

LEDiving® ADAPTER

The mounting brackets offer an easy installation and compatibility for a variety of cars.



Features

- Fixes H7-LED lamps
- Fits for vehicles types with H7 adapter
- Tight manufacturing tolerances for correct position of the H7-LED lamp

Benefits

- Ensure precise light distribution from the H7-LED lamp and enjoy the benefits of LED lighting
- Replaces the original H7 adapter
- Proven OSRAM quality for greater customer satisfaction with a 3-year guarantee¹⁾

LEDiving® ADAPTER

Product Reference	EAN		ECE	W	V	K	COLOR	Im			GUAR- ANTEE (YEAR)
64210DA01-1	4062172206532	-	Acc. for H7-LED	-	-	-	-	-	2	20	3
64210DA02	4062172160414	-	Acc. for H7-LED	-	-	-	-	-	2	20	3
64210DA03-1	4062172201872	-	Acc. for H7-LED	-	-	-	-	-	2	20	3
64210DA04	4062172175029	-	Acc. for H7-LED	-	-	-	-	-	2	20	3
64210DA05	4062172233170	-	Acc. for H7-LED	-	-	-	-	-	2	20	3
64210DA06-1	4062172201902	-	Acc. for H7-LED	-	-	-	-	-	2	20	3
64210DA07	4062172233835	-	Acc. for H7-LED	-	-	-	-	-	2	20	3
64210DA08	4062172242745	-	Acc. for H7-LED	-	-	-	-	-	2	20	3
64210DA09	4062172360203	-	Acc. for H7-LED	-	-	-	-	-	2	20	3
64210DA10	4062172360234	-	Acc. for H7-LED	-	-	-	-	-	2	20	3

LEDiving® ERROR CANCELER

Some vehicles report a fault in the exterior lighting when LED lamps are used. With the OSRAM LEDiving® SMART CANBUS series, potential error messages in the on-board system are avoided.



Features

- Error message and flicker free
- Individual vehicle testing approved by official authorities (KBA)
- Robust component

Benefits

- Potential error messages in the on-board system are avoided
- Convert from halogen lamps to LED lamps with original OSRAM accessories
- Proven OSRAM quality for greater customer satisfaction with a 3-year guarantee¹⁾

LEDiving® ERROR CANCELER LEDEC02

Product Reference	EAN		ECE	W	V	K	COLOR	Im			GUAR- ANTEE (YEAR)
LEDEC02-2HB	4062172383721	PX26D	Acc. for H7-LED	1	12	-	-	-	2	4	3

¹⁾ For precise conditions please refer to www.osram.com/am-guarantee.

LEDiving® CAP

Enables the installation of the H7-LED lamps. Replacement of original cap in OSRAM quality.



Features

- Enables the installation of the H7-LED lamps
- Mechanical fit and protects headlight system
- System component for H7-LED installation

Benefits

- Replacement of original cap
- Enjoy the benefits of LED lighting
- Proven OSRAM quality for greater customer satisfaction with a 3-year guarantee¹⁾

LEDiving® CAP

Product Reference	EAN		ECE	W	V	K	COLOR	Im			GUAR- ANTEE (YEAR)
LEDCAP01	4062172241878	Carspecific	VW Passat B7	-	-	-	-	-	2	8	-
LEDCAP02	4062172241908	Carspecific	Ford Focus MK4	-	-	-	-	-	2	8	-
LEDCAP03	4062172271394	Carspecific	Audi A1	-	-	-	-	-	2	8	-
LEDCAP04	4062172278560	Carspecific	VW T-cross	-	-	-	-	-	2	8	-
LEDCAP06	4062172305952	Carspecific	Hyundai ix20	-	-	-	-	-	2	8	-
LEDCAP07	4062172305983	Carspecific	Opel Zafira C-Tourer & Astra J	-	-	-	-	-	2	8	-
LEDCAP08	4062172309509	Carspecific	Skoda Octavia	-	-	-	-	-	2	8	-
LEDCAP09	4062172309530	Carspecific	Peugeot 208 Facelift	-	-	-	-	-	2	8	-
LEDCAP11	4062172325981	Carspecific	Peugeot 308 (L II)	-	-	-	-	-	2	8	-
LEDCAP12	4062172326070	Carspecific	Ford Transit/Tourneo (Custom)	-	-	-	-	-	2	8	-

LEDiving® SMART CANBUS

Some vehicles report a fault in the exterior lighting when LED lamps are used. With the OSRAM LEDiving® SMART CANBUS series, potential error messages in the on-board system are avoided.



Features

- Error message free
- Individual vehicle testing approved by official authorities (KBA)
- High-quality aluminum housing and black anodized surface with IP protection class IP54

Benefits

- Potential error messages in the on-board system are avoided
- Convert from halogen lamps to LED lamps with original OSRAM accessories
- Proven OSRAM quality for greater customer satisfaction with a 3-year guarantee¹⁾

LEDiving® SMART CANBUS

Product Reference	EAN		ECE	W	V	K	COLOR	Im			GUAR- ANTEE (YEAR)
LEDSC01-2HFB	4062172176439	PX26D	Acc. for H7-LED	12	12	-	-	-	2	4	3
LEDSC02-1-2HFB	4062172176460	Carspecific	Acc. for H7-LED	16	12	-	-	-	2	4	3
LEDSC03-2HFB	4062172176491	Carspecific	Acc. for H7-LED	12	12	-	-	-	2	4	3
LEDSC03-1-2HFB	4062172278249	Carspecific	Acc. for H7-LED	12	12	-	-	-	2	4	3
LEDSC04-2HB	4062172400725	P(U)43T	Acc. for H4/H19-LED	15	12	-	-	-	2	4	3
LEDSC10-2HB	4062172400695	PX26D	Acc. for H7-LED 24V	20	24	-	-	-	2	4	3

¹⁾ For precise conditions please refer to www.osram.com/am-guarantee.

LEDiving® CANBUS CONTROL UNIT

The LEDiving® CANBUS CONTROL UNIT serves as a bypass of a vehicle's lamp failure detection system when using a LED retrofit lamp.



Features

- Error free – Prevents error messages in board computers during failure detection
- Click connection thanks to faston terminals with fix wiretap connectors
- Individual vehicle testing approved by official authorities (KBA)
- Robust component

Benefits

- Enjoy full benefits of your LED upgrade by replacing your conventional lamps
- Removable installation by fixed clips
- Convert from halogen lamps to LED lamps with original OSRAM accessories
- Proven OSRAM quality for greater customer satisfaction with a 3-year guarantee¹⁾

LEDiving® CANBUS CONTROL UNIT

Product Reference	EAN		ECE	W	V	K	COLOR	lm			GUARANTEE (YEAR)
LEDCCU01-2HFB	4052899090873	Universal	Acc. for W5W-LED	5	12	-	-	-	2	20	3

To ensure compliance, follow these simple guidelines when fitting NIGHT BREAKER® LED lamps:

1

Identify approval numbers
Make sure the approval number matches the number on the head light fixtures.

2

Provide an approval certificate
Motorists are required to carry an approval certificate when they drive. Download the certificate at www.osram.com/nbl-abg, print it out and hand it to your customer.

3

Attach product sticker (optional)
For additional proof of certification, place the product sticker in the engine compartment.

¹⁾ For precise conditions please refer to www.osram.com/am-guarantee.

The perfect upgrade for your business

With the NIGHT BREAKER® LED range on your shelves, you can give customers the light upgrades they've been waiting for.



Talk to your customers about the "Three Facts of Light".

1. **Check & change:** headlights fade over time. Replace before they break.
2. **Change in pairs:** balanced light enhances safety.
3. **Upgrade your vision:** superior brightness means you can see further, react sooner, and avoid danger.

Recommend NIGHT BREAKER® LED lamps

"Did you know that LED upgrades have recently been made street legal¹⁾?"

"Would you like a free brightness test?
You can never be too careful when it comes to your safety."

"Great news, your vehicle is compatible with OSRAM NIGHT BREAKER® LED lamps. Would you like a quote for installation?"

1) Approved LED light source – only applies to the respective countries in which there is approval or to which an equivalent approval applies, and the vehicle models and light functions currently listed in the compatibility list. For more details see www.osram.com/nb-led.

Installation guide

Fitting NIGHT BREAKER® LED lamps and their accessories is easy.

H7 Installation with steel clamp

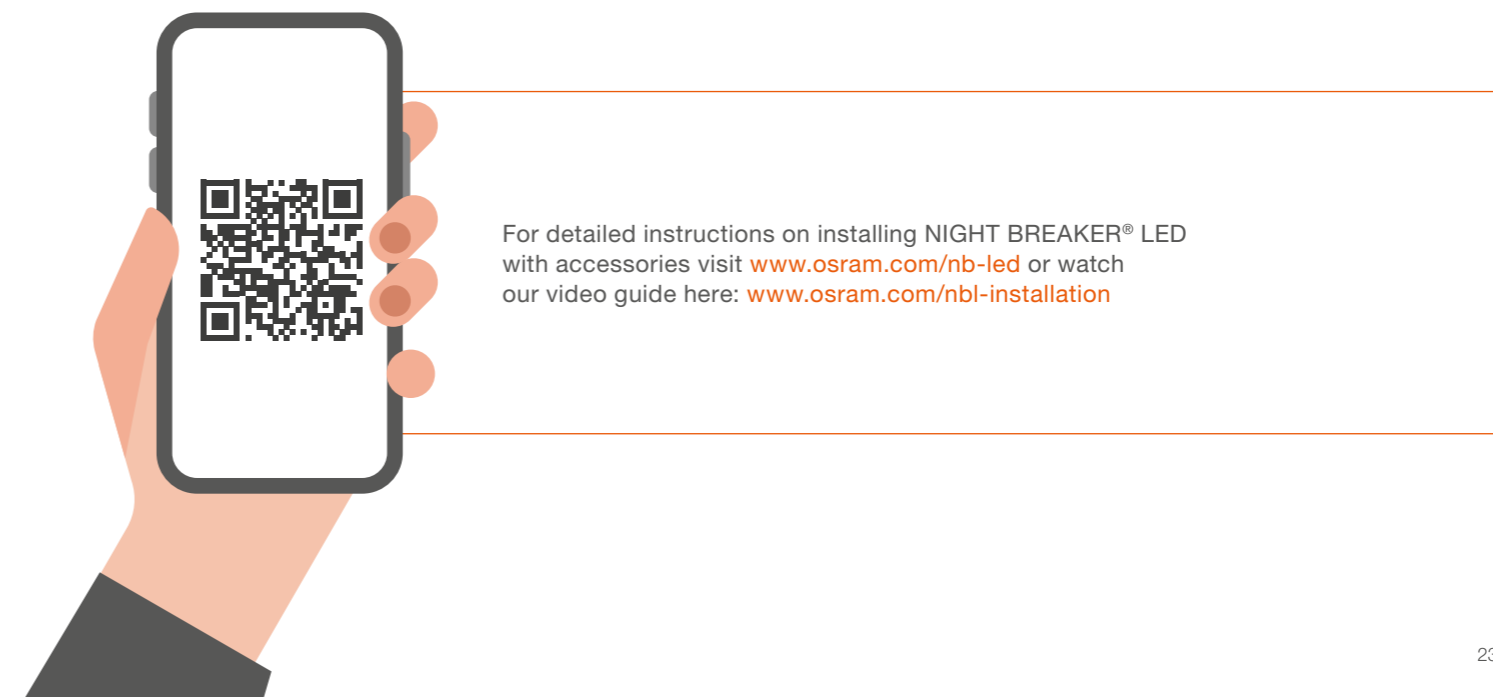
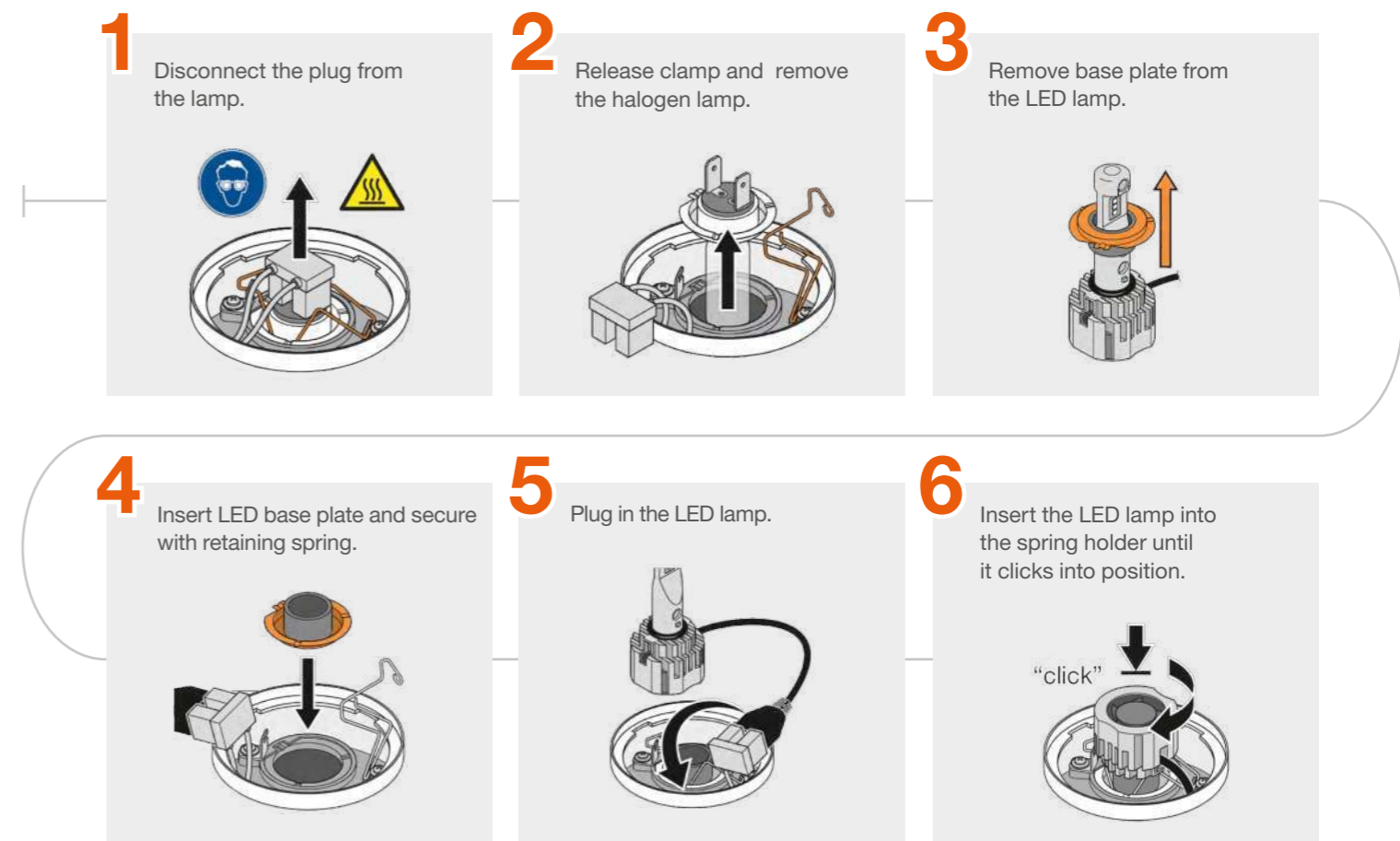

For detailed instructions on installing NIGHT BREAKER® LED with accessories visit www.osram.com/nb-led or watch our video guide here: www.osram.com/nbl-installation

OSRAM LED On-Road Lamps – Measurements

NIGHT BREAKER® LED

<p>NIGHT BREAKER® LED SPEED (H7-LED)</p>	<p>NIGHT BREAKER® LED SMART (H4-LED) 64193DWNBSM-2HB 64193DWNBSM</p>	<p>NIGHT BREAKER® LED SMART (H7-LED) 64210DWNBSM-2HB 64210DWNBSM</p>
<p>NIGHT BREAKER® LED GEN 2 (H7-LED) 64210DWNBG2-2HFB 64210DWNBG2</p>	<p>NIGHT BREAKER® LED (H1-LED) 64150DWNB-2HFB</p>	<p>NIGHT BREAKER® LED (W5W-LED) 2825DWNB-2HFB</p>
<p>TRUCKSTAR® LED (H7-LED) 64215DWTS-2HFB</p>		

LEDDriving® ACCESSORIES

<p>LEDDriving® ADAPTER (Acc. for H7-LED) 64210DA01-1</p>	<p>LEDDriving® ADAPTER (Acc. for H7-LED) 64210DA02</p>	<p>LEDDriving® ADAPTER (Acc. for H7-LED) 64210DA03-1</p>	<p>LEDDriving® ADAPTER (Acc. for H7-LED) 64210DA04</p>	<p>LEDDriving® ADAPTER (Acc. for H7-LED) 64210DA05</p>
<p>LEDDriving® ADAPTER (Acc. for H7-LED) 64210DA07</p>	<p>LEDDriving® ADAPTER (Acc. for H7-LED) 64210DA08</p>	<p>LEDDriving® ADAPTER (Acc. for H7-LED) 64210DA09</p>	<p>LEDDriving® ADAPTER (Acc. for H7-LED) 64210DA10</p>	

LEDDriving® ACCESSORIES

<p>LEDDriving® ERROR CANCELER (Acc. for H7-LED) LEDEC02-2HB</p>	<p>LEDDriving® CAP (VW Passat B7) LEDCAPO1</p>	<p>LEDDriving® CAP (Ford Focus MK4) LEDCAPO2</p>	<p>LEDDriving® CAP (Audi A1) LEDCAPO3</p>	<p>LEDDriving® CAP (VW T-cross) LEDCAPO4</p>	
<p>LEDDriving® CAP (Hyundai ix20) LEDCAPO6</p>	<p>LEDDriving® CAP (Opel Zafira C-Tourer & Astra J) LEDCAPO7</p>	<p>LEDDriving® CAP (Skoda Octavia) LEDCAPO8</p>	<p>LEDDriving® CAP (Peugeot 208 Facelift) LEDCAPO9</p>	<p>LEDDriving® CAP (Peugeot 308 (L II)) LEDCAPO11</p>	<p>LEDDriving® CAP (Ford Transit/Tourneo (Custom)) LEDCAPO12</p>
<p>LEDDriving® SMART CANBUS (Acc. for H7-LED) LEDSC01-2HFB</p>	<p>LEDDriving® SMART CANBUS (Acc. for H7-LED) LEDSC02-1-2HFB</p>	<p>LEDDriving® SMART CANBUS (Acc. for H7-LED) LEDSC03-2HFB</p>			
<p>LEDDriving® SMART CANBUS (Acc. for H7-LED) LEDSC03-1-2HFB</p>	<p>LEDDriving® SMART CANBUS (Acc. for H4/H19 LED) LEDSC04-2HB</p>	<p>LEDDriving® SMART CANBUS (Acc. for H7-LED 24 V) LEDSC10-2HB</p>			
<p>LEDDriving® CANBUS CONTROL UNIT (Acc. for W5W-LED) LEDCCU01-2HFB</p>					



LED Off-Road Lamps

Upgrade your vision



OSRAM-quality guaranteed
 All OSRAM products are extensively stress tested by our quality assurance system. For information concerning guarantees, visit www.osram.com/am-guarantee or scan the QR code.

1

LEDriving® HL
 Step up to the next level with OSRAM LEDriving® HL forward lighting lamps.



2

LEDriving® SL
 Stand out with style and quality with OSRAM LEDriving® SL lamps for signal and interior lighting.



3

LEDriving® HLM
 See and be seen with OSRAM LEDriving® HLM EASY forward lighting lamps for motorcycles.



4

LEDriving® Accessories
 Enjoy full benefits of your LED upgrade by replacing your conventional lamps with the help of OSRAM LEDriving® Accessories.





Up to +400% more brightness.¹⁾²⁾

More light allows to see farther and therefore react sooner.

1 LEDDriving® HL

Good, better, best: an upgrade for every desire

Impressive in terms of performance, design and quality – OSRAM LEDriving® HL lamps for high and low beam headlights offer a convenient solution to upgrade your car with superior brightness and cool white light that not only increases visibility, but also improves styling with a more dynamic look. These top-quality LED replacement lamps are equipped with the latest technology. With the wide range of offered solutions, everyone finds the best fit whether that's easy installation and affordability, broad compatibility or high-performance upgrades.



Very compact LED:
Replacements for conventional high and low beam lamps.



Cool White:
Color temperature of up to 6 500 K.²⁾ Better visibility thanks to daylight effect.



Guarantee:
For precise conditions please refer to www.osram.com/am-guarantee.²⁾

1) Compared to minimum ECE R112. 2) Please check for the concrete types.

LEDriving® HL EASY GEN 2

Socket design Plug & Play LED retrofit lamps with optimized compatibility and up to +120% more brightness.¹⁾



Features

- Up to +120 more brightness¹⁾
- Ultra compact LED replacement for conventional high and low beam lamps as socket solution
- Optimized high-speed fan ensures active cooling
- Cool White color temperature of 6 500 K
- Longer lifetime²⁾

Benefits

- More light allows to recognize obstacles and hazards sooner
- Easy Plug & Play installation with optimized compatibility that fits into more car models
- Higher performance and high-level light output thanks to maximized heat dissipation
- Better visibility thanks to daylight effect
- More durability due to LED technology

LEDriving® HL EASY GEN 2

Product Reference	EAN	Socket	ECE	W	V	K	COLOR	lm	Beam	Temp	GUARANTEE (YEAR)
64193DWESY2-2HB	4062172406918	P43t/PU43t-3	△H4/H19	25/25	12	6500	Cool White	1400/1800	2	10	-
64210DWESY2-2HB	4062172406932	PX26d/PY26d-1	△H7/H18	16	12	6500	Cool White	2000	2	10	-

LEDriving® HL EASY

Socket design Plug & Play LED retrofit lamps – no adapters or caps needed.



Features

- Ultra compact LED replacement for conventional high and low beam lamps as socket solution
- Optimized high-speed fan ensures active cooling
- Cool White color temperature of up to 6 500 K³⁾
- Superior brightness
- Longer lifetime²⁾

Benefits

- Easy Plug & Play installation
- Higher performance and high-level light output thanks to maximized heat dissipation
- Better visibility thanks to daylight effect
- More light allows to recognize obstacles and hazards sooner
- More durability due to LED technology

LEDriving® HL EASY

Product Reference	EAN	Socket	ECE	W	V	K	COLOR	lm	Beam	Temp	GUARANTEE (YEAR)
64150DWESY-2HB	4062172398039	P14.5s	△H1	9	12	6500	Cool White	1100	2	10	-
64151DWESY-2HB	4062172398053	PK22s	△H3	8	12	6500	Cool White	900	2	10	-
64193DWESY-2HB	4062172398077	P43t/PU43t-3	△H4/H19	19/19	12	6500	Cool White	1150/1400	2	10	-
64210DWESY-2HB	4062172398091	PX26d/PY26d-1	△H7/H18	16	12	6500	Cool White	1400	2	10	-
64176DWESY-2HB	4062172398350	PGJ23t-1	△H15	17/4	12	6500	Cool White	1250/250	2	10	-
64211DWESY-2HB	4062172401890	PGJ19-1/2/3	△H8/H11/H16	8.2	12	6000	Cool White	720	2	10	-
9145DWESY-2HB	4062172401913	PY20d	△H10	8.2	12	6000	Cool White	720	2	10	-

1) Compared to minimum ECE R112. 2) Compared to halogen lamps. 3) Please check for the concrete types.

LEDriving® HL BRIGHT

Wide range of LED retrofit lamps with high lumen output and up to +300% more brightness.¹⁾



Features

- Up to +300% more brightness¹⁾
- Multi-compatible smart reference ring ensures a very compact LED replacement for a wide range of conventional high and low beam lamps
- Cool White color temperature of 6 000 K
- Up to 5 times more lifetime²⁾
- Premium OSRAM quality

Benefits

- More light allows to recognize obstacles and hazards sooner
- Reduced glaring thanks to an optimized light distribution
- Better visibility thanks to daylight effect
- More durability due to LED technology
- 4-year guarantee³⁾

LEDriving® HL BRIGHT

Product Reference	EAN		ECE	W	V	K	COLOR	lm			GUARANTEE (YEAR)
64150DWBRT-2HFB	4062172315579	P14.5s	±H1	13	12	6000	Cool White	1500	2	8	4
64193DWBRT-2HFB	4062172315913	P43t/PU43t-3	±H4/H19	15/15	12	6000	Cool White	1100/1400	2	8	4
64210DWBRT-2HFB	4062172315937	PX26d/PY26d-1	±H7/H18	19	12	6000	Cool White	1700	2	8	4
64211DWBRT-2HFB	4062172315951	PGJ19-2/PGJ19-5/PGJ19-1/PGJ19-3	±H8/H11/H16/H9	19	12	6000	Cool White	1900	2	8	4
9005DWBRT-2HFB	4062172315975	P20d/PX20d /PY20d	±HB3(9005)/H10/HIR1	19	12	6000	Cool White	1900	2	8	4
9006DWBRT-2HFB	4062172315999	P22d/PX22d	±HB4(9006)/HIR2	19	12	6000	Cool White	1900	2	8	4
9008DWBRT-2HFB	4062172316019	P26.4t	±H13(9008)	15/10	12	6000	Cool White	1100/1500	2	8	4

LEDriving® HL INTENSE NXT

OSRAM's highest performing LED retrofit lamps with up to +400% more brightness.⁴⁾



Features

- Up to +400% more brightness⁴⁾
- CANBUS free
- Top OSRAM technology provides optimized beam pattern
- Improved thermal management technology with integrated active cooling
- Premium OSRAM quality

Benefits

- More light allows to recognize obstacles and hazards sooner
- Easy installation with wide range of suitable OSRAM accessories for installation
- Reduced glaring thanks to an optimized light distribution
- High speed fan ensures maximized heat dissipation for more powerful performances
- 5-year guarantee³⁾

LEDriving® HL INTENSE NXT

Product Reference	EAN		ECE	W	V	K	COLOR	lm			GUARANTEE (YEAR)
64193DWINN-2HB	4062172408158	P43t	±H4	42/40	12	6500	Cool White	2500/3500	2	8	5
64210DWINN-2HB	4062172408172	PX26d	±H7	42	12	6500	Cool White	4000	2	8	5

1) Compared to minimum ECE R112 valid for H4/H19 and H7/H18. 2) Compared to halogen lamps. 3) For precise conditions please refer to www.osram.com/am-guarantee. 4) Compared to minimum ECE R112.

LEDriving® HL VINTAGE

High performing LED retrofit lamps with warm white light color for classic cars.



Features

- Warm White color temperature of 2 700 K
- Very stable electric behavior even when installed on old electric
- Lower current absorption¹⁾
- No UV emission and very low operation temperature
- Premium OSRAM quality

Benefits

- The precise halogen-like color temperature creates a perfect stylish old-fashioned look for your car
- Very stable light emission
- Reduced load on old electric cables
- No damaging or further aging of old headlights
- 4-year guarantee²⁾

LEDriving® HL VINTAGE

Product Reference	EAN		ECE	W	V	K	COLOR	lm			GUARANTEE (YEAR)
64150DWWNT-2MB	4062172384810	P14.5s	±H1	13	12	2700	Warm White	1200	2	8	4
64193DWWNT-2MB	4062172384834	P43t/PU43t-3/P45t	±H4/H19/R2	14/14	12	2700	Warm White	1100/1400	2	8	4
64210DWWNT-2MB	4062172384858	PX26d/PY26d-1	±H7/H18	18	12	2700	Warm White	1600	2	8	4

1) Compared to halogen lamps. 2) For precise conditions please refer to www.osram.com/am-guarantee.

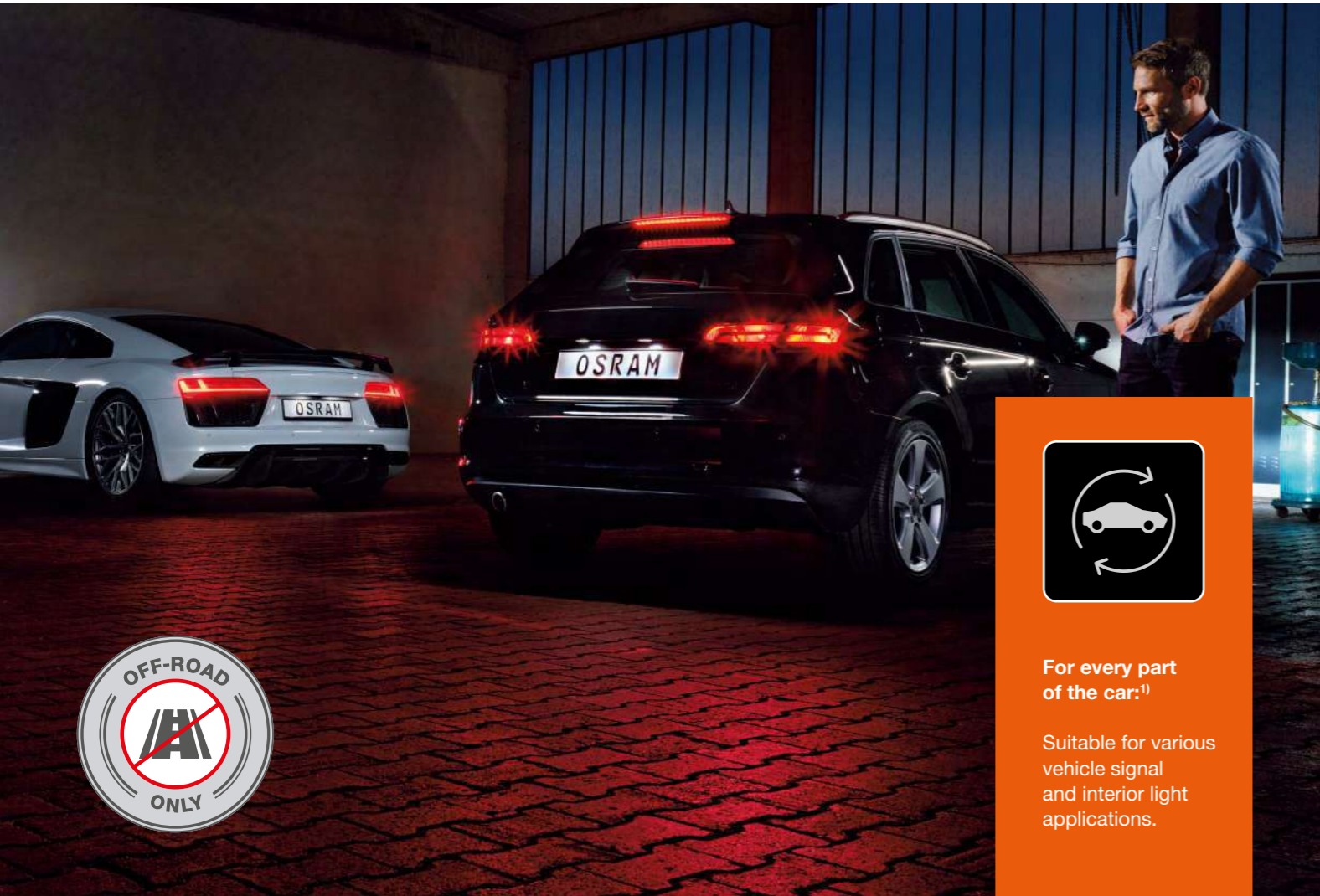

For every part of the car:¹⁾

Suitable for various vehicle signal and interior light applications.

2 LEDDriving® SL

Quality you can count on

OSRAM's LEDDriving® signal lamps for front and back signal lighting make your car shine and contribute to the driver's safety by providing faster signals and increasing the reaction time of other drivers: available in cool white, amber and red color. From dome light to foot area, from glovebox to trunk the OSRAM LEDDriving® interior LED lights create an attractive glow with an appealing contemporary touch.



Very compact LED:
Replacements for conventional auxiliary lamps.



Various color versions:
Available in 3 different colors.²⁾



Guarantee:
For precise conditions please refer to www.osram.com/am-guarantee.

¹⁾ Please check for the concrete applications. ²⁾ Please check for the concrete types.

LEDRIVING® SL

LED retrofit lamps with a modern and intense light for signal and interior applications.



Features

- Replaces conventional interior and exterior auxiliary lamps
- Red, Yellow and Cool White color temperature of 6 000 K
- Premium OSRAM quality

Benefits

- Easy installation with optimized compatibility
- Better visibility in foggy situations with a perfect color match with xenon and LED headlights
- 4-year guarantee¹⁾

LEDRIVING® SL

Product Reference	EAN	Icon	ECE	W	V	K	COLOR	lm	Icon	Icon	GUARANTEE (YEAR)
6438DWP-1BL	4062172401135	SV8.5-8	△C5W (31 mm)	1	12	6000	Cool White	45	1	5	4
6418DWP-1BL	4062172401159	SV8.5-8	△C5W (36 mm)	0.6	12	6000	Cool White	45	1	5	4
6413DWP-1BL	4062172401173	SV8.5-8	△C5W (41 mm)	0.6	12	6000	Cool White	45	1	5	4
7528DWP-2BL	4062172401197	BAY15d	△P21/5W	1.7	12	6000	Cool White	145/30	2	10	4
7528DRP-2BL	4062172401319	BAY15d	△P21/5W	1.7	12	-	Red	100/10	2	10	4
7528DYP-2BL	4062172401333	BAY15d	△P21/5W	1.9	12	-	Yellow	55/10	2	10	4
7506DWP-2BL	4062172401210	BA15s	△P21W	1.4	12	6000	Cool White	160	2	10	4
7506DYP-2BL	4062172401357	BA15s	△P21W	1.3	12	-	Yellow	50	2	10	4
7506DRP-2BL	4062172401371	BA15s	△P21W	1.4	12	-	Red	100	2	10	4
7507DYP-2BL	4062172401517	BAU15s	△PY21W	1.3	12	-	Yellow	50	2	10	4
3893DWP-2BL	4062172401234	BA9s	△T4W	1	12	6000	Cool White	75	2	10	4
2825DWP-2BL	4062172401258	W2.1x9.5d	△W5W	1	12	6000	Cool White	70	2	20	4
2827DYP-2BL	4062172401654	W2.1x9.5d	△W5W	1	12	-	Yellow	7	2	10	4
2825DRP-2BL	4062172401692	W2.1x9.5d	△W5W	1	12	-	Red	15	2	10	4
5007DWP-2BL	4062172401272	BA15s	△R5W	0.5	12	6000	Cool White	50	2	10	4
5008DWP-2BL	4062172401296	BA15s	△R10W	1.2	12	6000	Cool White	125	2	10	4
921DWP-2BL	4062172401579	W2.1x9.5d	△W16W	2	12	6000	Cool White	280	2	10	4
921DRP-2BL	4062172401630	W2.1x9.5d	△W16W	1.4	12	-	Red	80	2	10	4
828DWP-2BL	4062172401432	PG18.5d-1	△P13W	1.8	12	6000	Cool White	130	1	10	4
5201DWP-2BL	4062172401456	PG20-1	△PS19W	1.8	12	6000	Cool White	140	1	10	4
7515DWP-2BL	4062172401494	W3x16q	△W21W/5W	1.7	12	6000	Cool White	155/25	2	10	4
7515DRP-2BL	4062172401531	W3x16q	△W21W/5W	1.7	12	-	Red	80/10	2	10	4
7515DYP-2BL	4052899520653	W3x16q	△W21W/5W	1.9	12	-	Yellow	55/10	2	10	4
7505DWP-2BL	4062172401555	W3x16d	△W21W	1.4	12	6000	Cool White	145	2	10	4
7505DYP-2BL	4062172401593	W3x16d	△W21W	1.3	12	-	Yellow	55	2	10	4
7505DRP-2BL	4062172401616	W3x16d	△W21W	1.4	12	-	Red	60	2	10	4
7504DYP-2BL	4062172401739	WX3x16d	△WY21W	1.4	12	-	Yellow	55	2	10	4
3157DWP-2BL	4062172401753	W2.5x16q	△P27/7W	1.7	12	6000	Cool White	145/30	2	10	4
3157DRP-2BL	4062172401777	W2.5x16q	△P27/7W	1.7	12	-	Red	60/10	2	10	4
3157DYP-2BL	4062172401791	W2.5x16q	△P27/7W	1.9	12	-	Yellow	55/10	2	10	4
2723DWP-2BL	4062172401838	W2x4.6d	△T5 (W2.3W)	0.25	12	6000	Cool White	25	2	10	4
2604DWP-1BL	4062172401852	PG20-7	△PSX24W	6.7	12	6000	Cool White	730	1	10	4

¹⁾ For precise conditions please refer to www.osram.com/am-guarantee.



Improved visibility:¹⁾

More light allows to see farther and therefore react sooner.

3 LEDriving® HLM

Maximum visibility

The OSRAM LEDriving® forward lighting lamps for motorcycles open up new options for adapting motorcycle lighting to individual requirements with innovative light sources. The OSRAM LEDriving® HLM EASY LED lamps offer high efficiency, performance and design. Having the right lighting plays an important role in safety, especially for motorcycles and scooters. In the dark, motorcycles are more difficult to see than cars and motorcyclists need 100% reliable lighting that ensures optimum illumination of the road and extend the time available to react.



Very compact LED:
Replacements for conventional high and low beam lamps.



Cool White:
Color temperature of up to 6 500 K.²⁾ Better visibility thanks to daylight effect.



Easy Plug & Play installation:
Allowing a high compatibility and an easy installation.

1) Compared to minimum ECE R112. 2) Please check for the concrete types.

LEDriving® HLM EASY

High and low beam socket design Plug & Play LED retrofit lamps for motorcycles.



Features

- Compact Plug & Play design
- Cool White color temperature of up to 6 500 K¹⁾
- Superior brightness
- Optimized high-speed fan ensures active cooling
- Longer lifetime²⁾

Benefits

- Easy Plug & Play installation
- Better visibility thanks to daylight effect
- More light allows to recognize obstacles and hazards sooner
- Higher performance and high-level light output thanks to maximized heat dissipation
- More durability due to LED technology

LEDriving® HLM EASY

Product Reference	EAN	Socket	ECE	W	V	K	COLOR	lm	Beam	Quantity	GUAR-ANTEE (YEAR)
64193DWESY-1HB	4062172399821	P43t/PU43t-3	△H4/H19	19/19	12	6500	Cool White	1100/1400	1	5	-
64210DWESY-1HB	4062172399845	PX26d/PY26d-1	△H7/H18	16	12	6500	Cool White	1400	1	5	-
64185DWESY-1HB	4062172399869	PX43t	△HS1	5/5.5	12	6000	Cool White	500/650	1	5	-
7335DWESY-1HB	4062172399883	P15d-25-1	△T19 (M5)	4.5/5.5	12	6000	Cool White	500/600	1	5	-

1) Please check for the concrete types. 2) Compared to halogen lamps.

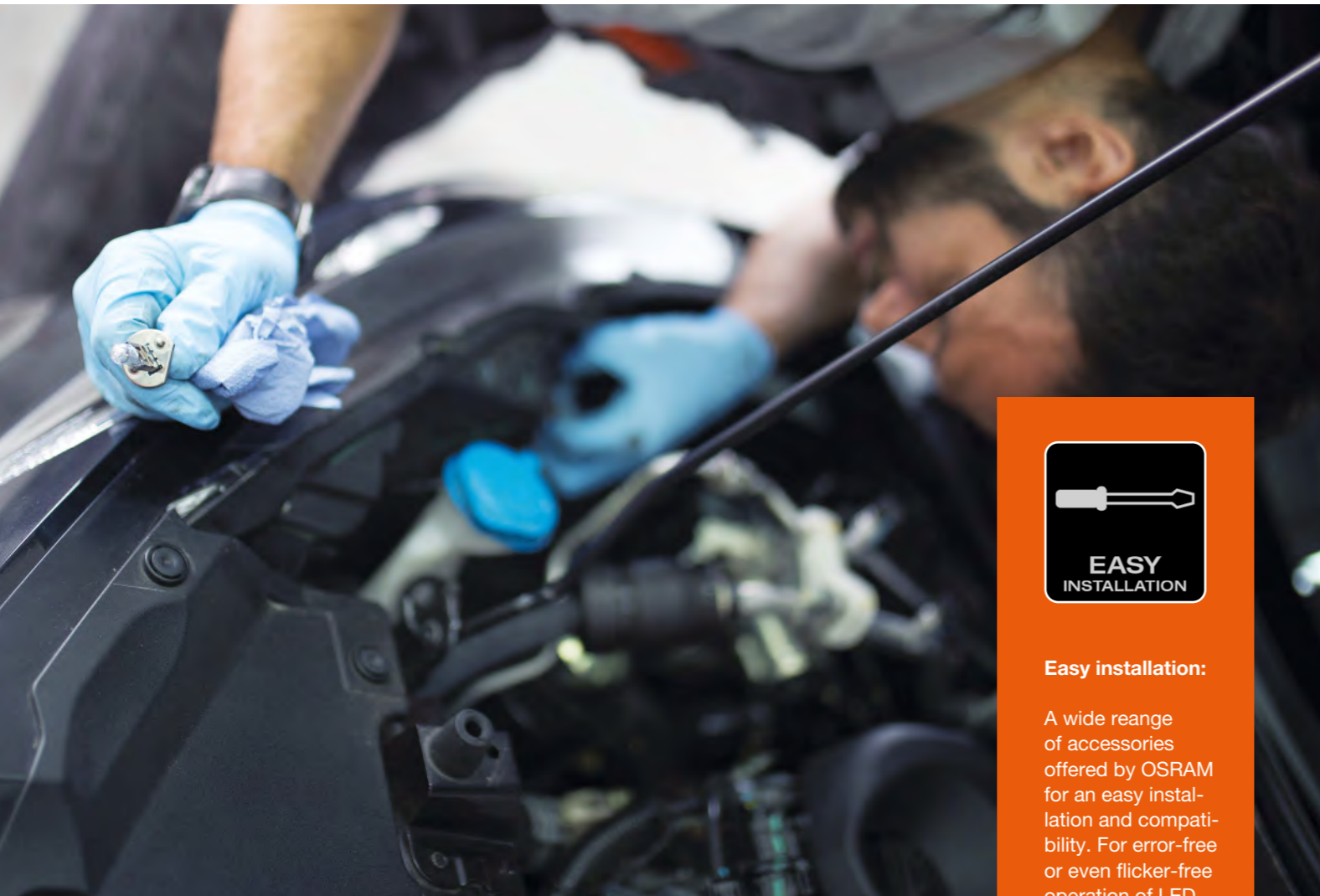

Easy installation:

A wide range of accessories offered by OSRAM for an easy installation and compatibility. For error-free or even flicker-free operation of LED lamps.

LEDDriving® ADAPTER

The mounting brackets offer an easy installation and compatibility for a variety of cars.



Features

- Fixes H7-LED lamps
- Fits for vehicles types with H7 adapter
- Tight manufacturing tolerances for correct position of the H7-LED lamp

Benefits

- Ensure precise light distribution from the H7-LED lamp and enjoy the benefits of LED lighting
- Replaces the original H7 adapter
- Proven OSRAM quality for greater customer satisfaction with a 3-year guarantee¹⁾

LEDDriving® ADAPTER

Product Reference	EAN		ECE	W	V	K	COLOR	lm			GUAR- ANTEE (YEAR)
64210DA01	4062172160384	-	H7 LED	-	-	-	-	-	2	20	3
64210DA01-1	4062172206532	-	H7 LED	-	-	-	-	-	2	20	3
64210DA02	4062172160414	-	H7 LED	-	-	-	-	-	2	20	3
64210DA03	4062172183840	-	H7 LED	-	-	-	-	-	2	20	3
64210DA03-1	4062172201872	-	H7 LED	-	-	-	-	-	2	20	3
64210DA04	4062172175029	-	H7 LED	-	-	-	-	-	2	20	3
64210DA05	4062172233170	-	H7 LED	-	-	-	-	-	2	20	3
64210DA06	4062172183932	-	H7 LED	-	-	-	-	-	2	20	3
64210DA06-1	4062172201902	-	H7 LED	-	-	-	-	-	2	20	3
64210DA07	4062172233835	-	H7 LED	-	-	-	-	-	2	20	3
64210DA08	4062172242745	-	H7 LED	-	-	-	-	-	2	20	3
64210DA09	4062172360203	-	H7 LED	-	-	-	-	-	2	20	3
64210DA10	4062172360234	-	H7 LED	-	-	-	-	-	2	20	3

4 LEDDriving® Accessories

Easy upgrade, essential benefits

Convert from halogen to LED with original OSRAM accessories: LEDDriving® ADAPTER, LEDDriving® SMART CANBUS, LEDDriving® CAP's and LEDDriving® ERROR CANCELER that make the installation easy and error message free.¹⁾



Robust and resistant: For a durable application.



Error message free: Potential error messages on vehicle dashboards are avoided.



Guarantee: For precise conditions please refer to www.osram.com/am-guarantee.

¹⁾ Only the combination of OSRAM LED lamps in conjunction with the official OSRAM accessories – LEDDriving® ADAPTER, LEDDriving® SMART CANBUS, LEDDriving® CAP's and LEDDriving® ERROR CANCELER is approved for the operation of our LED lamps.

¹⁾ For precise conditions please refer to www.osram.com/am-guarantee.

LEDDriving® CAP

Enables the installation of the H7-LED lamps. Replacement of original cap in OSRAM quality.



Features

- Enables the installation of the H7-LED lamps
- Mechanical fit and protects headlight system
- System component for H7-LED installation

Benefits

- Replacement of original cap
- Enjoy the benefits of LED lighting
- Proven OSRAM quality for greater customer satisfaction with a 3-year guarantee¹⁾

LEDDriving® CAP

Product Reference	EAN		ECE	W	V	K	COLOR	Im				GUAR- ANTEE (YEAR)
LEDCAP01	4062172241878	Carspecific	VW Passat B7	-	-	-	-	-	2	8	-	-
LEDCAP02	4062172241908	Carspecific	Ford Focus MK4	-	-	-	-	-	2	8	-	-
LEDCAP03	4062172271394	Carspecific	Audi A1	-	-	-	-	-	2	8	-	-
LEDCAP04	4062172278560	Carspecific	VW T-cross	-	-	-	-	-	2	8	-	-
LEDCAP06	4062172305952	Carspecific	Hyundai ix20	-	-	-	-	-	2	8	-	-
LEDCAP07	4062172305983	Carspecific	Opel Zafira C-Tourer & Astra J	-	-	-	-	-	2	8	-	-
LEDCAP08	4062172309509	Carspecific	Skoda Octavia	-	-	-	-	-	2	8	-	-
LEDCAP09	4062172309530	Carspecific	Peugeot 208 Facelift	-	-	-	-	-	2	8	-	-
LEDCAP10	4062172325912	Carspecific	Renault Scenic 3 (pre-facelift)	-	-	-	-	-	2	8	-	-
LEDCAP11	4062172325981	Carspecific	Peugeot 308 (L II)	-	-	-	-	-	2	8	-	-
LEDCAP12	4062172326070	Carspecific	Ford Transit/Tourneo (Custom)	-	-	-	-	-	2	8	-	-

LEDDriving® ERROR CANCELER

Some vehicles report a fault in the exterior lighting when LED lamps are used. With the OSRAM LEDDriving® SMART CANBUS series, potential error messages in the on-board system are avoided.



Features

- Error message and flicker free
- Individual vehicle testing approved by official authorities (KBA)
- Robust component

Benefits

- Potential error messages in the on-board system are avoided
- Convert from halogen lamps to LED lamps with original OSRAM accessories
- Proven OSRAM quality for greater customer satisfaction with a 3-year guarantee¹⁾

LEDDriving® ERROR CANCELER LEDEC02

Product Reference	EAN		ECE	W	V	K	COLOR	Im				GUAR- ANTEE (YEAR)
LEDEC02-2HB	4062172383721	PX26D	H7 LED	1	12	-	-	-	2	4	3	-

¹⁾ For precise conditions please refer to www.osram.com/am-guarantee.

LEDDriving® SMART CANBUS

Some vehicles report a fault in the exterior lighting when LED lamps are used. With the OSRAM LEDDriving® SMART CANBUS series, potential error messages in the on-board system are avoided.



Features

- Error message free
- Individual vehicle testing approved by official authorities (KBA)
- High-quality aluminum housing and black anodized surface with IP protection class IP54

Benefits

- Potential error messages in the on-board system are avoided
- Convert from halogen lamps to LED lamps with original OSRAM accessories
- Proven OSRAM quality for greater customer satisfaction with a 3-year guarantee¹⁾

LEDDriving® SMART CANBUS

Product Reference	EAN		ECE	W	V	K	COLOR	Im				GUAR- ANTEE (YEAR)
LEDSC01-2HFB	4062172176439	PX26D	H7 LED	12	12	-	-	-	2	4	3	-
LEDSC02-1-2HFB	4062172176460	Carspecific	H7 LED	16	12	-	-	-	2	4	3	-
LEDSC03-2HFB	4062172176491	Carspecific	H7 LED	12	12	-	-	-	2	4	3	-
LEDSC03-1-2HFB	4062172278249	Carspecific	H7 LED	12	12	-	-	-	2	4	3	-
LEDSC04-2HB	4062172400725	P(U)43T	H4/H19 LED	15	12	-	-	-	2	4	3	-
LEDSC05-2HB	4062172400756	PGJ19-X	H8/H9/H11/H16 LED	15	12	-	-	-	2	4	3	-
LEDSC06-2HB	4062172400787	P(Y)20/22D	H10/HB3/HB4 LED	15	12	-	-	-	2	4	3	-

LEDDriving® CANBUS CONTROL UNIT

The LEDDriving® CANBUS CONTROL UNIT serves as a bypass of a vehicle's lamp failure detection system when using a LED retrofit lamp.



Features

- Error free – Prevents error messages in board computers during failure detection
- Click connection thanks to faston terminals with fix wiretap connectors
- Individual vehicle testing approved by official authorities (KBA)
- Robust component

Benefits

- Enjoy full benefits of your LED upgrade by replacing your conventional lamps
- Removable installation by fixed clips
- Convert from halogen lamps to LED lamps with original OSRAM accessories
- Proven OSRAM quality for greater customer satisfaction with a 3-year guarantee¹⁾

LEDDriving® CANBUS CONTROL UNIT

Product Reference	EAN		ECE	W	V	K	COLOR	Im				GUAR- ANTEE (YEAR)
LEDCCU01-2HFB	4052899090873	Universal	4W/5W LED	5	12	-	-	-	2	20	3	-
LEDCCU02-2HFB	4052899301993	Universal	21W LED	21	12	-	-	-	2	20	3	-

¹⁾ For precise conditions please refer to www.osram.com/am-guarantee.

LEDDriving® ACCESSORIES

<p>LEDDriving® ADAPTER (H7 LED) 64210DA01</p>	<p>LEDDriving® ADAPTER (H7 LED) 64210DA01-1</p>	<p>LEDDriving® ADAPTER (H7 LED) 64210DA02</p>	<p>LEDDriving® ADAPTER (H7 LED) 64210DA03</p>	<p>LEDDriving® ADAPTER (H7 LED) 64210DA03-1</p>	<p>LEDDriving® ADAPTER (H7 LED) 64210DA04</p>
<p>LEDDriving® ADAPTER (H7 LED) 64210DA05</p>	<p>LEDDriving® ADAPTER (H7 LED) 64210DA06</p>	<p>LEDDriving® ADAPTER (H7 LED) 64210DA06-1</p>	<p>LEDDriving® ADAPTER (H7 LED) 64210DA07</p>		
<p>LEDDriving® ADAPTER (H7 LED) 64210DA08</p>	<p>LEDDriving® ADAPTER (H7 LED) 64210DA09</p>	<p>LEDDriving® ADAPTER (H7 LED) 64210DA10</p>			
<p>LEDDriving® CAP (VW Passat B7) LEDCAP01</p>	<p>LEDDriving® CAP (Ford Focus MK4) LEDCAP02</p>	<p>LEDDriving® CAP (Audi A1) LEDCAP03</p>	<p>LEDDriving® CAP (VW T-cross) LEDCAP04</p>	<p>LEDDriving® CAP (Hyundai ix20) LEDCAP06</p>	<p>LEDDriving® CAP (Opel Zafira C-Tourer & Astra J) LEDCAP07</p>
<p>LEDDriving® CAP (Skoda Octavia) LEDCAP08</p>	<p>LEDDriving® CAP (Peugeot 208 Facelift) LEDCAP09</p>	<p>LEDDriving® CAP (Renault Scenic 3 (pre-facelift)) LEDCAP10</p>	<p>LEDDriving® CAP (Peugeot 308 (L II)) LEDCAP11</p>	<p>LEDDriving® CAP (Ford Transit/Tourneo (Custom)) LEDCAP12</p>	

LEDDriving® ACCESSORIES

<p>LEDDriving® ERROR CANCELER (H7 LED) LEDEC02-2HB</p>		
<p>LEDDriving® SMART CANBUS (H7 LED) LEDSC01-2HFB</p>	<p>LEDDriving® SMART CANBUS (H7 LED) LEDSC02-1-2HFB</p>	<p>LEDDriving® SMART CANBUS (H7 LED) LEDSC03-2HFB</p>
<p>LEDDriving® SMART CANBUS (H7 LED) LEDSC03-1-2HFB</p>	<p>LEDDriving® SMART CANBUS (H4/H19 LED) LEDSC04-2HB</p>	<p>LEDDriving® SMART CANBUS (H8/H9/H11/H16 LED) LEDSC05-2HB</p>
<p>LEDDriving® SMART CANBUS (H10/HB3/HB4 LED) LEDSC06-2HB</p>	<p>LEDDriving® CANBUS CONTROL UNIT (4W/5W LED) LEDCCU01-2HFB</p>	<p>LEDDriving® CANBUS CONTROL UNIT (21W LED) LEDCCU02-2HFB</p>



Xenon Headlight Lamps

More light means more visibility



OSRAM-quality guaranteed

All OSRAM products are extensively stress tested by our quality assurance system. For information concerning guarantees, visit www.osram.com/am-guarantee or scan the QR code.

1

XENARC® NIGHT BREAKER® 220

The most powerful xenon light from OSRAM.



2

XENARC® COOL BLUE® INTENSE

The extra white light with up to 6 200 K.



3

XENARC® COOL BLUE® BOOST¹⁾

Hyper white light with up to 7 000 K for off-road use.



4

XENARC® ULTRA LIFE

The durable light with up to four times longer lifetime.



5

XENARC® ORIGINAL

The original spare parts with four-year guarantee.



1) These products do not have ECE approval and must not be used on public roads in any exterior application. Public roads use leads to cancellation of operating license and loss of insurance coverage. Several countries forbid sale and use of these products. Please contact your local distributor for further information.



Up to 220% more brightness:¹⁾

More light allows to see farther and therefore react sooner.

XENARC® NIGHT BREAKER® 220



With up to 220% more brightness on the road compared to the minimum legal standard, these exceptionally bright headlight lamps offer up to 20% whiter xenon light¹⁾ and a beam length of up to 250 m.

Features

- Up to 220% more brightness¹⁾
- Up to 250 m long beam
- Up to 20% whiter light¹⁾
- 3-year guarantee²⁾

Benefits

- More light allows to see further and therefore react sooner
- Better visibility
- Modern look
- OSRAM quality for more customer satisfaction

XENARC® NIGHT BREAKER® 220

Product Reference	EAN		ECE	W	V	K	COLOR	lm			GUARANTEE (YEAR)
66140XN2 ³⁾⁴⁾	4062172398619	PK32d-2	D1S ⁵⁾	35	85	4500	White	3200 ⁶⁾	1	4	3
66140XN2-2HB ³⁾⁴⁾	4062172397735	PK32d-2	D1S ⁵⁾	35	85	4500	White	3200 ⁶⁾	2	4	3
66240XN2 ³⁾⁴⁾	4062172398640	P32d-2	D2S ⁵⁾	35	85	4500	White	3200 ⁶⁾	1	4	3
66240XN2-2HB ³⁾⁴⁾	4062172397766	P32d-2	D2S ⁵⁾	35	85	4500	White	3200 ⁶⁾	2	4	3
66340XN2 ³⁾⁴⁾	4062172398671	PK32d-5	D3S ⁵⁾	35	42	4400	White	3200 ⁶⁾	1	4	3
66340XN2-2HB ³⁾⁴⁾	4062172397797	PK32d-5	D3S ⁵⁾	35	42	4400	White	3200 ⁶⁾	2	4	3
66440XN2 ³⁾⁴⁾	4062172398701	P32d-5	D4S ⁵⁾	35	42	4400	White	3200 ⁶⁾	1	4	3
66440XN2-2HB ³⁾⁴⁾	4062172397827	P32d-5	D4S ⁵⁾	35	42	4400	White	3200 ⁶⁾	2	4	3

1 XENARC® NIGHT BREAKER® 220

Brightest OSRAM xenon light

XENARC® NIGHT BREAKER® 220 is the brightest OSRAM xenon light. This powerful lamp with efficient xenon technology ensures a better visibility on the road: up to 220% more brightness compared to the minimum legal standard. More light allows to see further and therefore react sooner. Added to this is the up to 250 meter long beam and up to 20% whiter light for more modern look (compared to the minimum legal standard). Discover the pure performance of XENARC® NIGHT BREAKER® 220 – the most powerful xenon light from OSRAM, available in D1S, D2S, D3S and D4S. Please note: XENARC lamp change is recommended to be carried out by a professional and in pairs.



Up to 250 m long beam:
For better visibility.



Up to 20% whiter light:¹⁾
Modern look.



3 YEAR OSRAM GUARANTEE
Guarantee:²⁾
OSRAM quality for more customer satisfaction.

1) Compared to minimum ECE R98/R99 requirements. 2) For precise conditions please refer to www.osram.com/am-guarantee.

1) Compared to minimum ECE R98/R99 requirements. 2) For precise conditions please refer to www.osram.com/am-guarantee. 3) To be operated only with approved electronic control gear. 4) XENARC® lamps should be replaced by a qualified mechanic. 5) Reduced UV emission. For projection headlights. ECE approval and DOT label. 6) ± 450 lm.

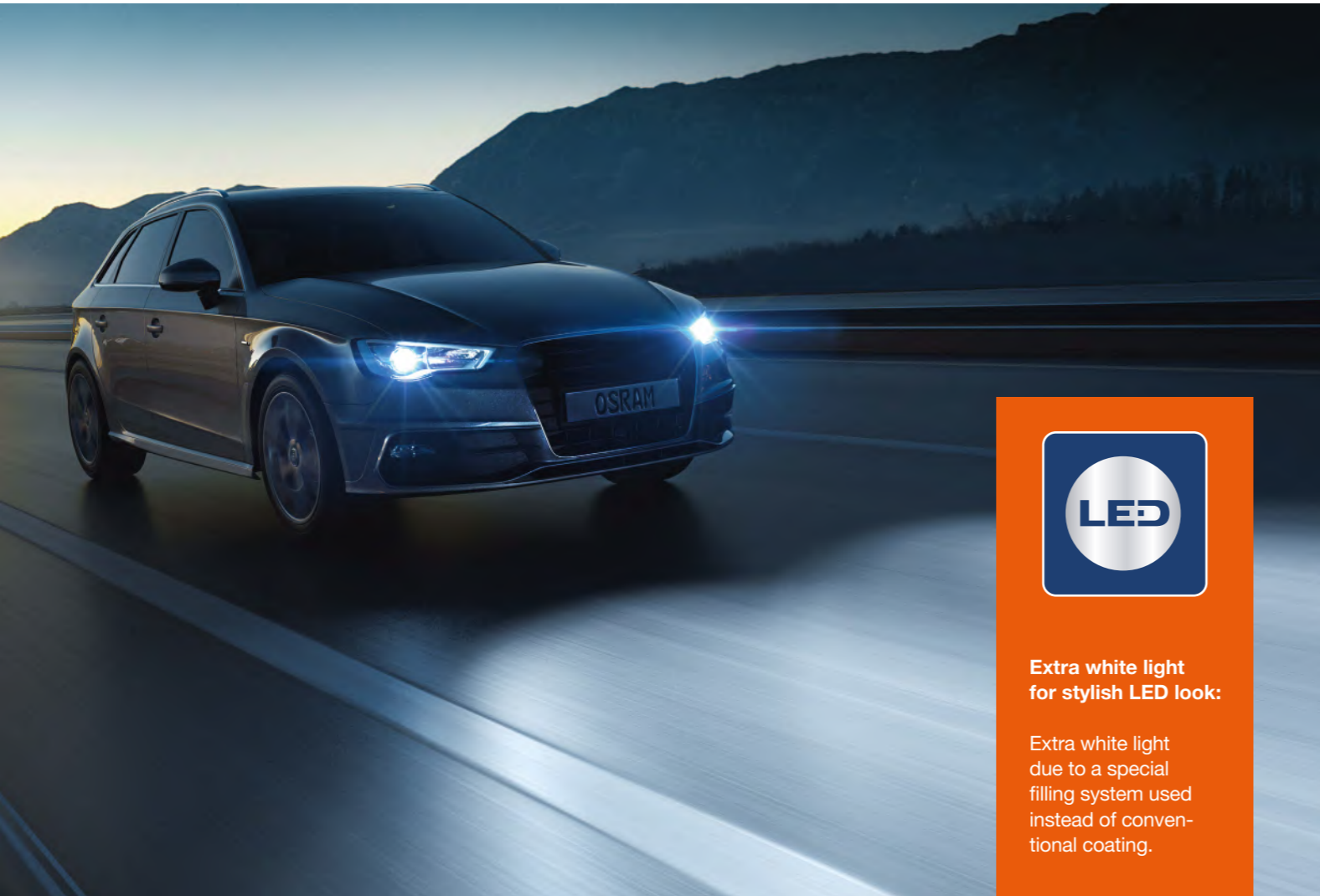



Extra white light for stylish LED look:

Extra white light due to a special filling system used instead of conventional coating.

XENARC® COOL BLUE® INTENSE



Exceptionally bright, high contrast and brilliantly white for LED look with up to 6 200 K: The high-tech xenon light comes with a highly efficient technology, brilliant effect and no-compromise design.

Features

- Extra white light for LED look
- Color temperatures of up to 6 200 K¹⁾²⁾
- Up to 150% more brightness¹⁾³⁾

Benefits

- Modern look on the road
- High contrast
- More light allows to see further and therefore react sooner

XENARC® COOL BLUE® INTENSE

Product Reference	EAN		ECE	W	V	K	COLOR	lm			GUARANTEE (YEAR)
66140CBN ⁴⁾⁵⁾	4062172157322	PK32d-2	D1S ⁶⁾	35	85	6200	White	3200 ⁸⁾	1	4	-
66140CBN-2HB ⁴⁾⁵⁾	4062172397643	PK32d-2	D1S ⁶⁾	35	85	6200	White	3200 ⁸⁾	2	4	-
66240CBN ⁴⁾⁵⁾	4062172157353	P32d-2	D2S ⁶⁾	35	85	6200	White	3200 ⁸⁾	1	4	-
66240CBN-2HB ⁴⁾⁵⁾	4062172397612	P32d-2	D2S ⁶⁾	35	85	6200	White	3200 ⁸⁾	2	4	-
66250CBN ⁴⁾⁵⁾	4062172216913	P32d-3	D2R ⁷⁾	35	85	6200	White	3200 ⁸⁾	1	4	-
66340CBN ⁴⁾⁵⁾	4062172157384	PK32d-5	D3S ⁶⁾	35	42	6200	White	3200 ⁸⁾	1	4	-
66340CBN-2HB ⁴⁾⁵⁾	4062172397674	PK32d-5	D3S ⁶⁾	35	42	6200	White	3200 ⁸⁾	2	4	-
66440CBN ⁴⁾⁵⁾	4062172157414	P32d-5	D4S ⁶⁾	35	42	6200	White	3200 ⁸⁾	1	4	-
66440CBN-2HB ⁴⁾⁵⁾	4062172397704	P32d-5	D4S ⁶⁾	35	42	6200	White	3200 ⁸⁾	2	4	-
66548CBN ⁴⁾⁵⁾	4062172148412	PK32d-1	D8S ⁶⁾	25	42	6200	White	3200 ⁸⁾	1	4	-

2 XENARC® COOL BLUE® INTENSE

Extra white light for LED look

XENARC® COOL BLUE® INTENSE – discover that modern look at high power! With its extra white light for LED look, high-contrast xenon light, this automotive lamp appeals especially to drivers who like the perfect combination of stylish and individual design with exceptional road illumination. The high-tech xenon light with color temperatures of up to 6 200 Kelvin comes up with a highly efficient technology, brilliant effect and no-compromise design. Thanks to a special filling system which is used instead of conventional coating the lamp emits its extra white light. This light creates a high-attention effect that helps you to be better seen by other motorists. Discover the exceptionally bright, high-contrast and brilliantly white light with up to 6 200 Kelvin and 150% more brightness! With XENARC® COOL BLUE® INTENSE, the night turns into day. Please note: XENARC lamp change is recommended to be carried out by a professional.



Up to 6 200 K:¹⁾²⁾

High contrast and brilliantly white light for most stylish and modern look on the road.



Up to 150% more brightness:¹⁾³⁾

More light allows to see farther and therefore react sooner.

1) D1S, D2S, D3S, D4S, D8S. 2) Measured in headlamps. 3) Compared to minimum ECE R98 requirements.

1) D1S, D2S, D3S, D4S, D8S. 2) Measured in headlamps. 3) Compared to minimum ECE R98 requirements. 4) To be operated only with approved electronic control gear. 5) XENARC® lamps should be replaced by a qualified mechanic. 6) Reduced UV emission / For projection headlights / ECE approval and DOT label. 7) Reduced UV emission. With anti-glare strip for reflection headlights. ECE approval and DOT label. 8) ± 450 lm.



Xenon hyper white light for stylish LED look:

Hyper white light due to a special filling system used instead of conventional coating.

XENARC® COOL BLUE® BOOST¹⁾



The XENARC® COOL BLUE® BOOST product families convince with hyper white light for LED look and high color temperatures. All lamps are designed and designed for off-road use only and not permitted on public roads.

Features

- Hyper white light for LED look
- Color temperatures of up to 7 000 K²⁾
- Enhanced brightness

Benefits

- Modern look on the road
- High contrast
- More light allows to see further and therefore react sooner

XENARC® COOL BLUE® BOOST

Product Reference	EAN		ECE	W	V	K	COLOR	lm			GUARANTEE (YEAR)
66140CBB-2HB	4062172404129	PK32d-2	~D1S	35	85	7000	White	3200 ±450	2	4	-
66240CBB-2HB	4062172404150	P32d-2	~D2S	35	85	7000	White	3200 ±450	2	4	-
66340CBB-2HB	4062172404181	PK32d-5	~D3S	35	42	7000	White	3000 ±450	2	4	-

3 XENARC® COOL BLUE® BOOST¹⁾

Hyper white light for LED look for off-road use

XENARC® COOL BLUE® BOOST features hyper white xenon light for LED look and high color temperatures of up to 7 000 K. This is due to a special filling system instead of conventional coating. The lamps generate enhanced brightness. These products do not have ECE approval. This means they must not be used on public roads in any exterior application. Use on public roads leads to cancellation of operating license and loss of insurance coverage. Several countries do not allow sale and use of these products. Please contact your local distributor for information on the availability in your country.



Up to 7 000 K:²⁾
High contrast and most stylish look.



Enhanced brightness:
More light allows to see farther and therefore react sooner.

1) These products do not have ECE approval and must not be used on public roads in any exterior application. Public roads use leads to cancellation of operating license and loss of insurance coverage. Several countries forbid sale and use of these products. Please contact your local distributor for further information. 2) Measured in headlamps.

1) These products do not have ECE approval and must not be used on public roads in any exterior application. Public roads use leads to cancellation of operating license and loss of insurance coverage. Several countries forbid sale and use of these products. Please contact your local distributor for further information. 2) Measured in headlamps.



XENARC® ULTRA LIFE

For additional reliability: With up to four times the lifespan of a standard lamp, XENARC® ULTRA LIFE headlight lamps come with a 10-year guarantee.¹⁾



Features

- 10-year guarantee¹⁾
- Up to 4 times longer lifetime²⁾
- Up to 300 000 km service life³⁾

Benefits

- Additional comfort due to reliable quality
- Saves time due to fewer workshop visits
- Longer replacement cycles

XENARC® ULTRA LIFE

Product Reference	EAN		ECE	W	V	K		lm			GUAR- ANTEE (YEAR)
66140ULT-2HB ⁴⁾⁵⁾	4062172404211	PK32d-2	D1S ⁶⁾	35	85	4300	White	3200 ⁷⁾	2	4	10
66240ULT-2HB ⁴⁾⁵⁾	4062172404242	P32d-2	D2S ⁶⁾	35	85	4300	White	3200 ⁷⁾	2	4	10
66340ULT-2HB ⁴⁾⁵⁾	4062172404273	PK32d-5	D3S ⁶⁾	35	42	4300	White	3200 ⁷⁾	2	4	10

4 XENARC® ULTRA LIFE

Superior life and 10-year guarantee

XENARC® ULTRA LIFE xenon lamps were developed with durability in mind. These long-life headlight lamps make life just that little bit more hassle-free, thanks to a lifetime up to four times longer compared to standard xenon lamps. Besides, these reliable lights impress with a service life up to 300 000 km (with an average annual mileage of 14 259 km and 60% light on)! For XENARC ULTRA LIFE lamps, OSRAM provides a unique 10 year guarantee for end consumers (www.osram.com/am-guarantee). Thus, you not only save money on costly replacements, but also save yourself future stress and downtime. Please note: XENARC lamp change is recommended to be carried out by a professional.



Up to 4 times longer lifetime:²⁾
Saves time due to fewer workshop visits.



Up to 300 000 km service life:³⁾
With an average annual mileage of 14 259 km and 60% light on (additional reliability).

1) For precise conditions please refer to www.osram.com/am-guarantee. 2) Compared to standard xenon lamps. 3) With an average annual mileage of 14 259 km and 60% light on.

1) For precise conditions please refer to www.osram.com/am-guarantee. 2) Compared to standard xenon lamps. 3) With an average annual mileage of 14 259 km and 60% light on. 4) To be operated only with approved electronic control gear. 5) XENARC® lamps should be replaced by a qualified mechanic. 6) Reduced UV emission. For projection headlights. ECE approval and DOT label. 7) ± 450 lm.



4

YEAR
OSRAM
GUARANTEE

4-year OSRAM guarantee:¹⁾

Additional comfort due to reliable quality.

5 XENARC® ORIGINAL

4-year guarantee

XENARC® ORIGINAL lamps impress with a wide product range and the reliable OEM quality. Successfully used in millions of new automobiles from renowned manufacturers, whether as standard initial equipment or original spare parts. With up to 4 500 Kelvin color temperature, their light is closer to natural daylight than conventional halogen light with 3 200 Kelvin – and is thus more pleasant for the eyes. Thanks to the impressive intensity of the light, the lamps provide better visibility on the road. The durable lamps function as original spare parts of your vehicle and convince with their long lifetime. OSRAM provides a 4-year-guarantee for XENARC® ORIGINAL lamps. Please note: XENARC lamp change is recommended to be carried out by a professional.



OEM Quality:
Tried and trusted in millions of vehicles of well-known manufacturers.



Premium quality made by OSRAM:
Original spare parts that exceed all ECE minimum standards.

XENARC® ORIGINAL



XENARC® ORIGINAL lamps impress with a wide product range and the reliable OEM quality. Successfully used in millions of new automobiles from renowned manufacturers, whether as standard initial equipment or original spare parts.

Features

- 4-year guarantee¹⁾
- OEM Quality
- Original spare parts that exceed all ECE minimum standards
- Wide product range

Benefits

- Additional comfort due to reliable quality
- Tried and trusted in millions of vehicles of well-known manufacturers
- Premium quality made by OSRAM
- Suitable for many xenon headlights

XENARC® ORIGINAL

Product Reference	EAN		ECE	W	V	K	COLOR	lm				GUAR- ANTEE (YEAR)
66140 ²⁾³⁾	4008321184276	PK32d-2	D1S ⁴⁾	35	85	4300	White	3200 ⁶⁾	1	4	4	4
66140-1HB ²⁾³⁾	4062172396806	PK32d-2	D1S ⁴⁾	35	85	4300	White	3200 ⁶⁾	1	4	4	4
66150 ²⁾³⁾	4052899339828	PK32d-3	D1R ⁵⁾	35	85	4300	White	2800 ⁶⁾	1	4	4	4
66240 ²⁾³⁾	4008321184573	P32d-2	D2S ⁴⁾	35	85	4300	White	3200 ⁶⁾	1	4	4	4
66240-1HB ²⁾³⁾	4062172396745	P32d-2	D2S ⁴⁾	35	85	4300	White	3200 ⁶⁾	1	4	4	4
66250 ²⁾³⁾	4008321184634	P32d-3	D2R ⁵⁾	35	85	4300	White	2800 ⁶⁾	1	4	4	4
66340 ²⁾³⁾	4052899199569	PK32d-5	D3S ⁴⁾	35	42	4300	White	3200 ⁶⁾	1	4	4	4
66340-1HB ²⁾³⁾	4062172396837	PK32d-5	D3S ⁴⁾	35	42	4300	White	3200 ⁶⁾	1	4	4	4
66440 ²⁾³⁾	4008321349392	P32d-5	D4S ⁴⁾	35	42	4300	White	3200 ⁶⁾	1	4	4	4
66440-1HB ²⁾³⁾	4062172396776	P32d-5	D4S ⁴⁾	35	42	4300	White	3200 ⁶⁾	1	4	4	4
66450 ²⁾³⁾	4008321349576	P32d-6	D4R ⁵⁾	35	42	4300	White	2800 ⁶⁾	1	4	4	4
66540 ²⁾³⁾ COMING SOON	4062172305457	PK32d-7	D5S	25	12	4400	White	2000 ⁷⁾	1	4	-	-
66548 ²⁾³⁾	4008321787019	PK32d-1	D8S ⁴⁾	25	42	4500	White	2000 ⁸⁾	1	4	4	4

¹⁾ For precise conditions please refer to www.osram.com/am-guarantee.

²⁾ To be operated only with approved electronic control gear. ³⁾ XENARC® lamps should be replaced by a qualified mechanic. ⁴⁾ Reduced UV emission / For projection headlights / ECE approval and DOT label. ⁵⁾ Reduced UV emission / With anti-glare strip for projection headlights / ECE approval and DOT label. ⁶⁾ ± 450 lm. ⁷⁾ ± 300 lm / -200 lm. ⁸⁾ ± 300 lm.

Shining a light on eco-friendly packaging

OSRAM premium quality lights are renowned for enhancing road safety and protecting your reputation in the automotive industry. Now, we're doing more to help protect the environment with plastic-free packaging for our entire lamp portfolio.

Considering your needs, your customers, and our commitment to combatting plastic waste, our LED, halogen, and xenon lamps will now be packaged in 100% plastic-free, recyclable materials, made from recycled resources.

The products haven't changed in any way, and neither have their prices, but this packaging upgrade goes a long way. Even without plastic, our new boxes and blisters provide the same excellent protection for the lamps inside.

The lamps themselves are no longer visible, but the bulbs are depicted in actual size on the cardboard box along with all the information you and your customers need.

The change in EANs and Order Numbers means that you will need to re-integrate these products on your systems. Once that's done, your customers will not only continue to enjoy better visibility on the roads but have made a small contribution to a brighter future.



OSRAM Xenon Headlight Lamps – Measurements

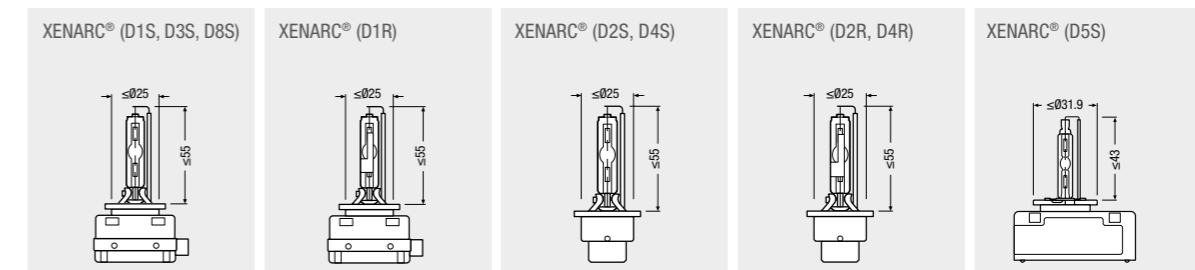

IEC/EN 60061-1 bases, IEC/EN 60061-2 lampholders

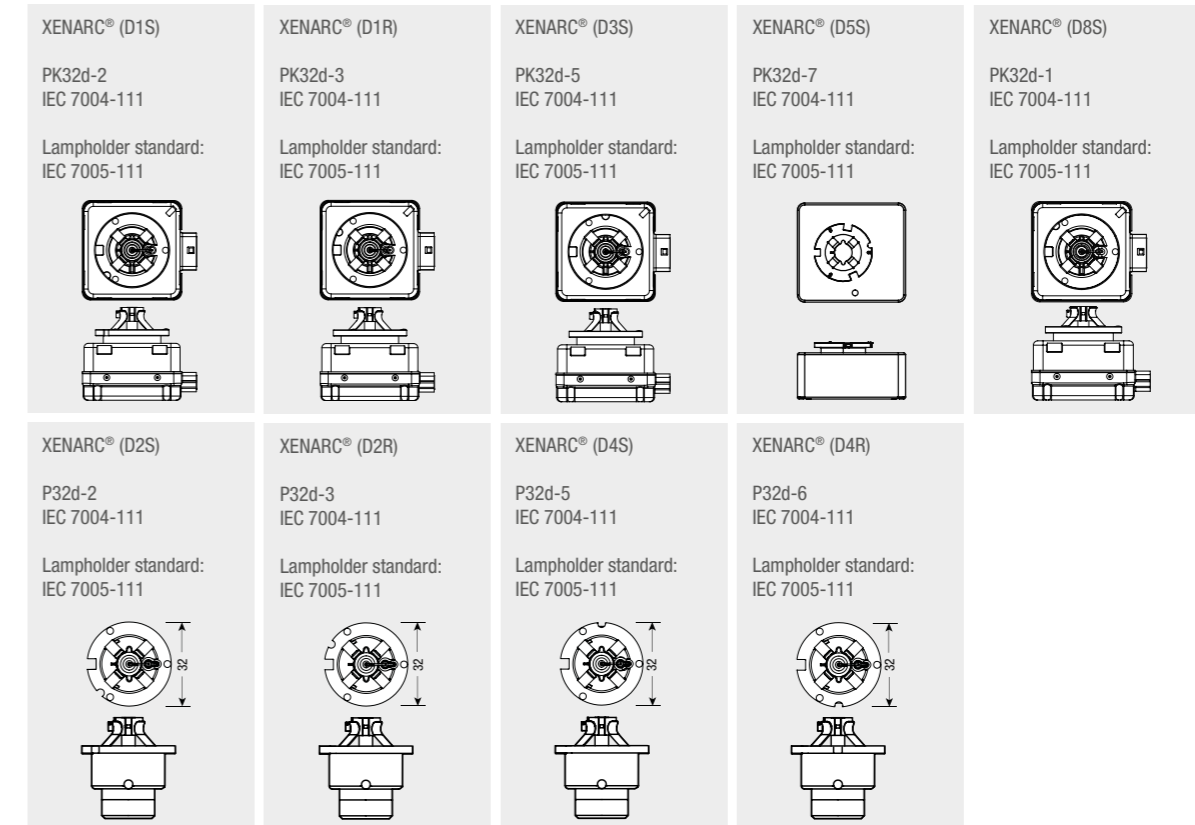



Halogen Lamps

Don't just meet standards – exceed them



OSRAM-quality guaranteed

All OSRAM products are extensively stress tested by our quality assurance system. For information concerning guarantees, visit www.osram.com/am-guarantee or scan the QR code.

1

NIGHT BREAKER® 220

Brightest OSRAM halogen light.



2

NIGHT BREAKER® LASER

Our 2nd most powerful halogen lamp.



3

NIGHT BREAKER® SILVER

Excellent performance-lifetime ratio.



4

COOL BLUE® INTENSE

Extra white light for LED look.



5

DIADEM® CHROME

Only amber light during operation.



6

ULTRA LIFE
Longer life and 4-year guarantee.



7

ORIGINAL 12 V
Original spare part.



8

MINIBOX
Mobile lamp replacement.



9

ORIGINAL MOTORCYCLE
Vibration-resistant technology.



10

SUPER BRIGHT¹⁾ / SUPER BRIGHT PREMIUM¹⁾
Extra power for off-road use.



11

COOL BLUE[®] BOOST¹⁾
Hyper white light for off-road use.



Shining a light on eco-friendly packaging

OSRAM premium quality lights are renowned for enhancing road safety and protecting your reputation in the automotive industry. Now, we're doing more to help protect the environment with plastic-free packaging for our entire lamp portfolio.

Considering your needs, your customers, and our commitment to combatting plastic waste, our LED, halogen, and xenon lamps will now be packaged in 100% plastic-free, recyclable materials, made from recycled resources.

The products haven't changed in any way, and neither have their prices, but this packaging upgrade goes a long way. Even without plastic, our new boxes and blisters provide the same excellent protection for the lamps inside.

The lamps themselves are no longer visible, but the bulbs are depicted in actual size on the cardboard box along with all the information you and your customers need.

The change in EANs and Order Numbers means that you will need to re-integrate these products on your systems. Once that's done, your customers will not only continue to enjoy better visibility on the roads but have made a small contribution to a brighter future.



¹⁾ These products do not have ECE approval and must not be used on public roads in any exterior application. Public roads use leads to cancellation of operating license and loss of insurance coverage. Several countries forbid sale and use of these products. Please contact your local distributor for further information.



Up to 220% more brightness:¹⁾

More light allows to see farther and therefore react sooner.

NIGHT BREAKER® 220

Outshining all other OSRAM halogen lamps: NIGHT BREAKER® 220 headlight lamps excel with up to 220% more brightness compared to the minimum legal standard, up to 150 m long beam and new gold cap.



Features

- Up to 220% more brightness¹⁾
- Up to 150 m long beam
- Up to 20% whiter light¹⁾
- Gold cap

Benefits

- More light allows to see further and therefore react sooner
- Better visibility
- Modern look
- Signs, obstacles and hazards can be recognized sooner

NIGHT BREAKER® 220

Product Reference	EAN											
-------------------	-----	--	--	--	--	--	--	--	--	--	--	--

NIGHT BREAKER® 220 – halogen lamps

Product Reference	EAN	Part Number	Base	Power (W)	Voltage (V)	Color Temp (K)	Color	Lumen (lm)	Beam Diameter (mm)	Beam Length (m)	Beam Area (m²)	Guarantee (Year)
64193NB220	4062172399449	P43t	H4	60/55	12	4050	White	1650/1000	1	100	-	-
64193NB220-2HB	4062172399555	P43t	H4	60/55	12	4050	White	1650/1000	2	10	-	-
64210NB220	4062172399340	PX26d	H7	55	12	3700	White	1500	1	100	-	-
64210NB220-2HB	4062172399579	PX26d	H7	55	12	3700	White	1500	2	10	-	-
64211NB220	4062172399418	PGJ19-2	H11	55	12	3750	White	1350	1	100	-	-
64211NB220-2HB	4062172399593	PGJ19-2	H11	55	12	3750	White	1350	2	10	-	-

1 NIGHT BREAKER® 220

The most powerful halogen light from OSRAM

Enter the next light level: With NIGHT BREAKER® 220 – the brightest halogen automotive light from OSRAM! These cutting-edge headlight lamps impress with up to 220% more brightness and up to 20% whiter light compared to the minimum legal standard and generate an up to 150 m long beam. More light and improved visibility can help drivers identify and react to traffic hazards more quickly. The ideal lamp for drivers who appreciate the difference that powerful automotive lighting makes. Available in H4, H7 and H11 with a new gold cap.



Up to 150 m long beam:
Better visibility.



Gold cap:
Modern look.



Up to 20% whiter light:
Signs, obstacles and hazards can be recognized sooner.

¹⁾ Compared to minimum ECE R112/R37 requirements.

¹⁾ Compared to minimum ECE R112/R37 requirements.



Up to 150% more brightness:¹⁾

More light allows to see farther and therefore react sooner.

2 NIGHT BREAKER® LASER

Strong halogen light for high demands

Thanks to innovative laser ablation technology, NIGHT BREAKER® LASER halogen headlight lamps shine up to 150% brighter compared to the minimum legal standard. The highly engineered filament ensures an extra light boost. Consequently, the lamps provide an up to 150 m long beam and up to 20% whiter light compared to the minimum legal standard. More light and improved visibility can help drivers identify and react to traffic hazards more quickly. Last but not least: OSRAM NIGHT BREAKER® LASER impresses with its unique design (laser-engraved product name) and complete portfolio (H1, H3, H4, H7, H8, H11, HB3, HB4).



Up to 150 m long beam:
Better visibility.



Up to 20% whiter light:
Modern look.

NIGHT BREAKER® LASER

Innovative laser ablation technology makes the NIGHT BREAKER® LASER up to 150% brighter than the minimum legal standard.



Features

- Up to 150% more brightness¹⁾
- Up to 150 m long beam
- Up to 20% whiter light¹⁾
- More light performance due to innovative laser ablation technology²⁾

Benefits

- More light allows to see further and therefore react sooner
- Better visibility
- Modern look
- Signs, obstacles and hazards can be recognized sooner

NIGHT BREAKER® LASER

Product Reference	EAN											
-------------------	-----	--	--	--	--	--	--	--	--	--	--	--

NIGHT BREAKER® LASER – halogen lamps

Product Reference	EAN	Product Code	Category	W	V	K	COLOR	lm	Box	Box	Box	GUARANTEE (YEAR)
64150NL	4052899991309	P14.5s	H1	55	12	3650	White	1550	1	100	-	-
64150NL-1BL	4062172395489	P14.5s	H1	55	12	3650	White	1550	1	100	-	-
64150NL-2HB	4062172388108	P14.5s	H1	55	12	3650	White	1550	2	10	-	-
64151NL	4052899991330	PK22s	H3	55	12	3700	White	1450	1	100	-	-
64151NL-2HB	4062172388160	PK22s	H3	55	12	3700	White	1450	2	10	-	-
64193NL	4052899991361	P43t	H4	60/55	12	4050	White	1650/1000	1	100	-	-
64193NL-1BL	4062172395700	P43t	H4	60/55	12	4050	White	1650/1000	1	100	-	-
64193NL-2HB	4062172387477	P43t	H4	60/55	12	4050	White	1650/1000	2	10	-	-
64210NL	4052899991392	PX26d	H7	55	12	3750	White	1500	1	100	-	-
64210NL-1BL	4062172395168	PX26d	H7	55	12	3750	White	1500	1	100	-	-
64210NL-2HB	4062172387590	PX26d	H7	55	12	3750	White	1500	2	10	-	-
64212NL	4052899998827	PGJ19-1	H8	35	12	3650	White	800	1	100	-	-
64212NL-2HB	4062172387774	PGJ19-1	H8	35	12	3650	White	800	2	10	-	-
64211NL	4052899991422	PGJ19-2	H11	55	12	3750	White	1350	1	100	-	-
64211NL-1BL	4062172395243	PGJ19-2	H11	55	12	3750	White	1350	1	100	-	-
64211NL-2HB	4062172387712	PGJ19-2	H11	55	12	3750	White	1350	2	10	-	-
9005NL	4052899998858	P20d	HB3	60	12	3850	White	1700	1	100	-	-
9005NL-2HB	4062172388283	P20d	HB3	60	12	3850	White	1700	2	10	-	-
9006NL	4052899998889	P22d	HB4	51	12	3950	White	1000	1	100	-	-
9006NL-2HB	4062172388320	P22d	HB4	51	12	3950	White	1000	2	10	-	-

1) Compared to minimum ECE R112/R37 requirements.

1) Compared to minimum ECE R112/R37 requirements. 2) H4/H7/H8/H11/HB3/HB4.



NIGHT BREAKER® SILVER

With up to 100% more brightness compared to the minimum legal standard, an excellent choice for motorists with high demands for performance and lifetime.



Features

- Up to 100% more brightness¹⁾
- Up to 130 m long beam
- Excellent performance-lifetime ratio

Benefits

- More light allows to see further and therefore react sooner
- Better visibility
- More light at a reasonable lifetime

NIGHT BREAKER® SILVER

Product Reference	EAN											
-------------------	-----	--	--	--	--	--	--	--	--	--	--	--

NIGHT BREAKER® SILVER – halogen lamps

Product Reference	EAN	Part No.	Base	W	V	K	Color	lm	Icon	Icon	Icon	Guarantee (Year)
64150NBS	4052899992573	P14.5s	H1	55	12	3200	White	1550	1	100	-	-
64150NBS-1BL	4062172395465	P14.5s	H1	55	12	3200	White	1550	1	100	-	-
64150NBS-2HB	4062172388085	P14.5s	H1	55	12	3200	White	1550	2	10	-	-
64193NBS	4052899992603	P43t	H4	60/55	12	3200	White	1650/1000	1	100	-	-
64193NBS-1BL	4062172395687	P43t	H4	60/55	12	3200	White	1650/1000	1	100	-	-
64193NBS-2HB	4062172387453	P43t	H4	60/55	12	3200	White	1650/1000	2	10	-	-
64210NBS	4052899992634	PX26d	H7	55	12	3200	White	1500	1	100	-	-
64210NBS-1BL	4062172395113	PX26d	H7	55	12	3200	White	1500	1	100	-	-
64210NBS-2HB	4062172387576	PX26d	H7	55	12	3200	White	1500	2	10	-	-
64211NBS	4052899992665	PGJ19-2	H11	55	12	3200	White	1350	1	100	-	-
64211NBS-2HB	4062172387699	PGJ19-2	H11	55	12	3200	White	1350	2	10	-	-

3 NIGHT BREAKER® SILVER

The OSRAM performance halogen light with best lifetime

With NIGHT BREAKER® SILVER, OSRAM offers a performance halogen automotive lamp with an optimized lifetime. OSRAM NIGHT BREAKER® SILVER generates up to 100% more brightness compared to the minimum legal standard and a beam which is up to 130 meters long. This allows you to see road signs, obstacles and hazards sooner and the driver is left with more time to react. In addition to this, these automotive lamps have a convincing price-performance ratio and a modern design with an attractive silver cap (H4/H7/H11). The perfect choice for drivers who place high demands on performance and lifetime.



Up to 130 m long beam:
Better visibility.



Excellent performance-lifetime ratio:
More light at a reasonable lifetime.

¹⁾ Compared to minimum ECE R112/R37 requirements.

¹⁾ Compared to minimum ECE R112/R37 requirements.



LED look:

Extra white light for stylish LED look.

4 COOL BLUE® INTENSE

The extra white light with up to 5 000 K

Discover COOL BLUE® INTENSE – high-tech halogen lamps, almost in the league of LED lamps. With its powerful and bright extra white light up to 5 000 Kelvin, whose cool beam makes it look very like a LED lamp, it gives real design fans their money’s worth. The automotive lamp also provides a high-contrast light similar to daylight, which makes it easier on the eyes than the light from standard lamps. In comparison to minimum ECE requirements, the OSRAM COOL BLUE® INTENSE range is up to 100% more brightness! The modern design with silver cap (H4/H7/H8/H11/HB4) is ideal for use in clear-glass headlights. That gives your car a stylish look.



Up to 5 000 Kelvin:¹⁾²⁾

High contrast and brilliantly white light for most stylish and modern look on the road.



Up to 100% more brightness:³⁾

More light allows to see farther and therefore react sooner.

COOL BLUE® INTENSE

Stylish LED look for your drive: High-tech halogen lamp, almost in the league of LED lamps with their extra white light.



Features

- Extra white light for LED look
- Color temperatures of up to 5 000 K¹⁾²⁾
- Up to 100% more brightness³⁾
- Modern design with silver cap⁴⁾

Benefits

- Modern and stylish look
- High contrast
- More light allows to see further and therefore react sooner
- Ideal for use in clear-glass headlights

COOL BLUE® INTENSE

Product Reference	EAN		ECE	W	V	K	COLOR	lm			GUARANTEE (YEAR)
-------------------	-----	--	-----	---	---	---	-------	----	--	--	------------------

COOL BLUE® INTENSE – halogen lamps

64150CBN	4058075520356	P14.5s	H1	55	12	5000	White	1550	1	100	-
64150CBN-1BL	4062172395403	P14.5s	H1	55	12	5000	White	1550	1	100	-
64150CBN-2HB	4062172388061	P14.5s	H1	55	12	5000	White	1550	2	10	-
64193CBN	4062172149334	P43t	H4	60/55	12	5000	White	1650/1000	1	100	-
64193CBN-1BL	4062172395625	P43t	H4	60/55	12	5000	White	1650/1000	1	100	-
64193CBN-2HB	4062172387415	P43t	H4	60/55	12	5000	White	1650/1000	2	10	-
64210CBN	4062172149358	PX26d	H7	55	12	5000	White	1500	1	100	-
64210CBN-1BL	4062172395038	PX26d	H7	55	12	5000	White	1500	1	100	-
64210CBN-2HB	4062172387538	PX26d	H7	55	12	5000	White	1500	2	10	-
64212CBN-2HB	4062172387750	PGJ19-1	H8	35	12	4800	White	800	2	10	-
64211CBN-2HB	4062172387651	PGJ19-2	H11	55	12	5000	White	1350	2	10	-
64176CBN	4062172215527	PGJ23t-1	H15	55/15	12	3700	White	1350/260	1	100	-
64176CBN-2HB	4062172387811	PGJ23t-1	H15	55/15	12	3700	White	1350/260	2	10	-
9005CBN-2HB	4062172388269	P20d	HB3	60	12	5000	White	1860	2	10	-
9006CBN-2HB	4062172388306	P22d	HB4	51	12	5000	White	1095	2	10	-
9012CBN	4062172215572	PX22d	HIR2	55	12	5000	White	1875	1	100	-

COOL BLUE® INTENSE – auxiliary lamps

2825CBN	4062172218757	W2.1x9.5d	W5W	5	12	4000	White	50	1	50	-
2825CBN-2BL	4062172394710	W2.1x9.5d	W5W	5	12	4000	White	50	2	20	-

1) H1, H4, H7, H11, HB3, HB4, HIR2. 2) CMeasured in headlamps. 3) Compared to minimum ECE R112 requirements.

1) H1, H4, H7, H11, HB3, HB4, HIR2. 2) Measured in headlamps. 3) Compared to minimum ECE R112 requirements. 4) H4, H7, H8, H11, HB4.

Chrome design:
Thanks to cutting edge interference and absorber coating.

5 DIADEM® CHROME

The design light with chrome look

OSRAM DIADEM® CHROME signal lamps have a strikingly exclusive design: their chrome look made possible by a cutting edge interference and absorber coating. The lamps emit amber light only when operational. At other times, they are almost invisible and have no irritating color effects. DIADEM® CHROME lamps are ideal for all indicator lights with clear covers.



Amber when ON:
Only amber when operating, otherwise almost invisible.



Homogenous appearance:
Reflector has a fully homogenous chrome look.

DIADEM® CHROME

Visual tuning for indicator lights: The signal lights DIADEM® CHROME only emit amber light during operation – making them the perfect, attractive light supplement for halogen and xenon headlamps.



Features

- Chrome design
- Amber when ON
- Homogenous appearance

Benefits

- Cutting edge interference and absorber coating
- Only amber when operating, otherwise almost invisible
- Exclusive chrome look

DIADEM® CHROME

Product Reference	EAN							
-------------------	-----	--	--	--	--	--	--	--

DIADEM® CHROME – auxiliary lamps

Product Reference	EAN	W	V	K	COLOR	lm	GUAR-ANTEE (YEAR)				
2827DC-2BL ¹⁾	4062172394758	W2.1x9.5d	WY5W	5	12	2200	Amber	30	2	20	-
7507DC-2BL ¹⁾	4062172394857	BAU15s	PY21W	21	12	2200	Amber	280	2	20	-

¹⁾ Amber light for clear indicator lights.



6 ULTRA LIFE

The durable light with up to four times longer lifetime

OSRAM ULTRA LIFE automotive lamps are a favorite when it comes to durability. They have an impressive lifespan up to four times longer compared to standard halogen lamps and last up to 100 000 km (with an average annual mileage of 14 259 km and 60% light on). OSRAM provides a 4 year guarantee for the reliable ULTRA LIFE headlight lamps (www.osram.com/am-guarantee). In addition to this, ULTRA LIFE headlight lamps have a modern design with silver cap (H4/H7/H11). They are therefore ideal for frequent drivers or people who use daytime running lights, and can also be used in clear-glass headlights.



Up to 4 times longer lifetime:

Saves time due to fewer workshop visits compared to standard lamps.



Up to 100 000 km service life:

With an average annual mileage of 14,259 km and 60% light on (additional reliability).

ULTRA LIFE

The ULTRA LIFE product family provides more reliability and durability. The lamps last up to four times longer compared to standard lamps and have a rock-solid guarantee of four years.



Features

- 4-year guarantee¹⁾
- Up to 4 times longer lifetime²⁾
- Up to 100 000 km service life³⁾

Benefits

- Additional comfort due to reliable quality
- Saves time due to fewer workshop visits
- Longer replacement cycles

ULTRA LIFE

Product Reference	EAN									
-------------------	-----	--	--	--	--	--	--	--	--	--

ULTRA LIFE – halogen lamps

64150ULT	4008321416209	P14.5s	H1	55	12	3200	White	1550	1	100	4
64150ULT-2HB	4062172388122	P14.5s	H1	55	12	3200	White	1550	2	10	4
64193ULT	4008321416230	P43t	H4	60/55	12	3200	White	1650/1000	1	100	4
64193ULT-1BL	4062172395748	P43t	H4	60/55	12	3200	White	1650/1000	1	100	4
64193ULT-2HB	4062172387491	P43t	H4	60/55	12	3200	White	1650/1000	2	10	4
64210ULT	4008321416261	PX26d	H7	55	12	3200	White	1500	1	100	4
64210ULT-1BL	4062172395205	PX26d	H7	55	12	3200	White	1500	1	100	4
64210ULT-2HB	4062172387613	PX26d	H7	55	12	3200	White	1500	2	10	4
64211ULT	4052899431164	PGJ19-2	H11	55	12	3200	White	1350	1	100	4
64211ULT-2HB	4062172387736	PGJ19-2	H11	55	12	3200	White	1350	2	10	4

ULTRA LIFE – auxiliary lamps

7506ULT	4008321415349	BA15s	P21W	21	12	2800	White	460	10	50	4
7506ULT-2BL	4062172394833	BA15s	P21W	21	12	2800	White	460	2	20	4
7507ULT ⁴⁾	4008321413147	BAU15s	PY21W	21	12	2200	Amber	280	10	50	4
7507ULT-2BL ⁴⁾	4062172394871	BAU15s	PY21W	21	12	2200	Amber	280	2	20	4
7528ULT	4008321413116	BAY15d	P21/5W	21/5	12	2800	White	440/30	10	50	4
7528ULT-2BL	4062172394895	BAY15d	P21/5W	21/5	12	2800	White	440/30	2	20	4
2825ULT	4008321413024	W2.1x9.5d	W5W	5	12	2800	White	50	10	50	4
2825ULT-2BL	4062172394734	W2.1x9.5d	W5W	5	12	2800	White	50	2	20	4
5007ULT	4008321415370	BA15s	R5W	5	12	2800	White	50	10	50	4
5007ULT-2BL	4062172394772	BA15s	R5W	5	12	2800	White	50	2	20	4
5008ULT-2BL	4062172394918	BA15s	R10W	10	12	2800	White	125	2	20	4
6418ULT	4008321413086	SV8.5-8	C5W	5	12	2800	White	45	10	50	4
64132ULT	4008321413178	BAX9s	H6W	6	12	2800	White	125	10	50	4
64132ULT-2BL	4062172394796	BAX9s	H6W	6	12	2800	White	125	2	20	4
64137 ⁴⁾	4052899910256	BAW9s	HY21W	21	12	2200	Amber	300	10	50	4

1) For precise conditions please refer to www.osram.com/am-guarantee.

1) For precise conditions please refer to www.osram.com/am-guarantee. 2) Compared with standard lamps. 3) With an average annual mileage of 14 259 km and 60% light on. 4) Amber light for clear indicator lights.



OEM Quality:

Tried and trusted in millions of vehicles of well-known manufacturers.

7 ORIGINAL 12 V

The cost-effective original spare parts

OSRAM ORIGINAL LINE halogen lamps offer convincing performance for standard requirements, are robust and cost-effective. They have already been successfully used in millions of new cars from renowned manufacturers, whether as standard initial equipment or original spare parts. Convince yourself of the excellent value for money, the reliable OEM quality and the wide product range of the ORIGINAL LINE.

Original spare parts that exceed all ECE minimum standards:
Premium quality made by OSRAM.

Wide product range:
Suitable for the most common applications.

ORIGINAL 12 V



Convincing performance for standard requirements, robust and cost-effective: Successfully used in millions of new cars from renowned manufacturers, whether as standard initial equipment or original spare parts.

Features

- OEM Quality
- Original spare parts that exceed all ECE minimum standards
- Wide product range

Benefits

- Tried and trusted in millions of vehicles of well-known manufacturers
- Premium quality made in Germany
- Suitable for many xenon headlights

ORIGINAL 12 V

Product Reference	EAN										
-------------------	-----	--	--	--	--	--	--	--	--	--	--

ORIGINAL 12 V – halogen lamps

Product Reference	EAN	Product Code	Light Type	W	V	K	Color	lm	Light Bulb Icon	Spare Part Icon	Guarantee (Year)
64150	405030001487	P14.5s	H1	55	12	3200	White	1550	1	100	-
64150-1BL	4062172395380	P14.5s	H1	55	12	3200	White	1550	1	100	-
64151	405030001494	PK22s	H3	55	12	3200	White	1450	1	100	-
64151-1BL	4062172395540	PK22s	H3	55	12	3200	White	1450	1	100	-
64193	405030001470	P43t	H4	60/55	12	3200	White	1650/1000	1	100	-
64193-1BL	4062172395601	P43t	H4	60/55	12	3200	White	1650/1000	1	100	-
64210	4050300332185	PX26d	H7	55	12	3200	White	1500	1	100	-
64210-1BL	4062172395014	PX26d	H7	55	12	3200	White	1500	1	100	-
64212	4050300498751	PGJ19-1	H8	35	12	3200	White	800	1	100	-
64212-1BL	4062172395281	PGJ19-1	H8	35	12	3200	White	800	1	100	-
64242	4008321055422	PGJY19-1	H8B	35	12	3200	White	800	1	100	-
64213	4050300524368	PGJY19-5	H9	65	12	3200	White	2100	1	100	-
64243	4008321055477	PGJY19-5	H9B	65	12	3200	White	2100	1	100	-
9145	4052899348622	PY20d	H10	42	12	3200	White	850	1	100	-
64211	4050300524313	PGJ19-2	H11	55	12	3200	White	1350	1	100	-
64211-1BL	4062172395229	PGJ19-2	H11	55	12	3200	White	1350	1	100	-
64241 ¹⁾	4008321054654	PGJY19-2	H11B	55	12	3200	White	1350	1	100	-
9008	4008321939401	P26.4tP26.4t	H13	60/55	12	3200	White	1700	1	100	-
64176	4008321218391	PGJ23t-1	H15	15/55	12	3200	White	1350/260	1	100	-
64219L+	4008321626783	-	H16	19	12	3200	White	500	1	100	-
64180L	4052899479968	PY26d-1	H18	55	12	3200	White	1700	1	100	-
64181L	4052899599017	PU43t-3	H19	60/55	12	3200	White	1750	1	100	-
880	4008321542977	PG13	H27W/1	27	12	3200	White	450	1	100	-
881	4008321543004	PGJ13	H21W/2	27	12	3200	White	450	1	100	-
9005	4050300137193	P20d	HB3	60	12	3200	White	1700	1	100	-
9005-1BL	4062172395304	P20d	HB3	60	12	3200	White	1700	1	100	-
9006	4050300012650	P22d	HB4	51	12	3200	White	1000	1	100	-
9006-1BL	4062172395328	P22DP22d	HB4	51	12	3200	White	1000	1	100	-
9006XS	4008321554284	P22d	HB4A	51	12	3200	White	1095	1	100	-
9007	4050300148816	PX29TPX29t	HB5	65/55	12	3200	White	2000	1	100	-
9012	4008321863997	PX22d	HIR2	55	12	3200	White	1875	1	100	-
9012-1BL	4062172395342	PX22d	HIR2	55	12	3200	White	1875	1	100	-

1) Amber light for clear indicator lights.

ORIGINAL 12 V

Product Reference	EAN										
-------------------	-----	--	--	--	--	--	--	--	--	--	--

ORIGINAL 12 V – auxiliary lamps

7506	4050300838120	BA15s	P21W	21	12	2800	White	460	1	50	-
7506-2BL	4062172396325	BA15s	P21W	21	12	2800	White	460	2	20	-
7507 ¹⁾	4050300891477	BAU15s	PY21W	21	12	2200	Amber	280	1	50	-
7507-2BL ¹⁾	4062172396349	BAU15s	PY21W	21	12	2200	Amber	280	2	20	-
7225	4050300891514	BAZ15d	P21/4W	21/4	12	2800	White	440/15	1	50	-
7225-2BL	4062172396226	BAZ15d	P21/4W	21/4	12	2800	White	440/15	2	20	-
7240	4050300838007	BA15d	-	21/5	12	2800	White	440/35	1	50	-
7528	4050300838069	BAY15d	P21/5W	21/5	12	2800	White	440/35	1	50	-
7528-2BL	4062172396448	BAY15d	P21/5W	21/5	12	2800	White	440/35	2	20	-
3860	4008321095756	BA9s	-	5	12	2800	White	50	1	50	-
3893	4050300838489	BA9s	T4W	4	12	2800	White	35	1	50	-
3893-2BL	4062172395984	BA9s	T4W	4	12	2800	White	35	2	20	-
2820	4008321094094	W2.1x9.5d	-	2	12	2800	White	13.5	1	50	-
2821	4050300838663	W2.1x9.5d	W3W	3	12	2800	White	22	1	50	-
2821-2BL	4062172395847	W2.1x9.5d	W3W	3	12	2800	White	22	2	20	-
2825	4050300838632	W2.1x9.5d	W5W	5	12	2800	White	50	1	50	-
2825-2BL	4062172395885	W2.1x9.5d	W5W	5	12	2800	White	50	2	20	-
2827NA ¹⁾	4052899570795	W2.1x9.5d	WY5W	5	12	2200	Amber	30	1	50	-
2827NA-2BL ¹⁾	4062172395946	W2.1x9.5d	WY5W	5	12	2200	Amber	30	2	20	-
2886X	4008321094667	W2.1x9.5d	-	6	12	2800	White	85	1	50	-
921	4008321100948	W2.1x9.5d	W16W	16	12	2800	White	310	1	50	-
921-2BL	4062172396486	W2.1x9.5d	W16W	16	12	2800	White	310	2	20	-
921NA ¹⁾	4052899230460	W2.1x9.5d	WY16W	16	12	2200	Amber	190	1	50	-
7504 ¹⁾	4008321165473	WX3x16d	WY21W	21	12	2200	Amber	280	1	50	-
7504-2BL ¹⁾	4062172396240	WX3x16d	WY21W	21	12	2200	Amber	280	2	20	-
7505	4052899324244	W3x16d	W21W	21	12	2800	White	460	1	50	-
7505-2BL	4062172396288	W3x16d	W21W	21	12	2800	White	460	2	20	-
7515	4052899324312	W3x16q	W21/5W	21/5	12	2800	White	440/35	1	50	-
7515-2BL	4062172396387	W3x16q	W21/5W	21/5	12	2800	White	440/35	2	20	-
2721	4050300838540	W2x4.6d	-	1.2	12	2800	White	7.5	1	50	-
2721-2BL	4062172395762	W2x4.6d	-	1.2	12	2800	White	7.5	2	20	-
2722	4008321094803	W2x4.6d	-	2	12	2800	White	12	1	50	-
2723	4008321094834	W2x4.6d	W2.3W	2.3	12	2800	White	18.6	1	50	-
64132	4008321094896	BAX9s	H6W	6	12	2800	White	125	1	50	-
64136	4008321095190	BAY9s	H21W	21	12	2800	White	600	1	50	-
5007	4050300838427	BA15s	R5W	5	12	2800	White	50	1	50	-
5007-2BL	4062172396028	BA15s	R5W	5	12	2800	White	50	2	20	-
5008	4050300838212	BA15s	R10W	10	12	2800	White	125	1	50	-
5008-2BL	4062172396066	BA15s	R10W	10	12	2800	White	125	2	20	-
5009 ¹⁾	4008321095442	BAU15s	RY10W	10	12	2200	Amber	75	1	50	-
6411 ²⁾	4050300891354	SV8.5-8	-	10	12	2800	White	75	1	50	-
6411-2BL ²⁾	4062172396080	SV8.5-8	-	10	12	2800	White	75	2	20	-
64111	4008321095015	BA9s	-	5	12	2800	White	80	1	50	-
64113	4008321095046	BA9s	-	10	12	2800	White	200	1	50	-
64115	4008321095077	BA9s	-	20	12	2800	White	450	1	50	-
6413	4050300891439	SV8.5-8	-	5	12	2800	White	45	1	50	-
6418	4050300838397	SV8.5-8	C5W	5	12	2800	White	45	1	50	-
6418-2BL	4062172396141	SV8.5-8	C5W	5	12	2800	White	45	2	20	-
6428	4008321094384	SV7-8	-	3	12	2800	White	29	1	50	-
6438	4008321094353	SV8.5-8	-	10	12	2800	White	120	1	50	-
6438-2BL	4062172396189	SV8.5-8	-	10	12	2800	White	120	2	20	-
6461	4008321094261	SV8.5-8	-	10	12	2800	White	105	1	50	-
6486X	4008321094292	SV8.5-8	-	6	12	2800	White	85	1	50	-

1) Amber light for clear indicator lights. 2) Also available with glass base (product reference 6411150 or 6411350).

ORIGINAL 12 V

Product Reference	EAN										
-------------------	-----	--	--	--	--	--	--	--	--	--	--

ORIGINAL 12 V – auxiliary lamps

2351MFX6	4008321096852	BX8.4d-12.5	-	1.2	12	2800	White	7.5	1	50	-
2352MFX6	4008321097149	BX8.4d-12.5	-	2	12	2800	White	11.8	1	50	-
2452MFX6	4008321097118	BX8.4d-12.5	-	1.5	12	2800	White	6.5	1	50	-
2473MFX6	4008321096821	BX8.4d-12.5	-	1.1	12	2800	White	3.6	1	50	-
2721MFX	4008321297150	BX8.5d	-	1.2	12	2800	White	6.4	1	50	-
2722MFX	4008321297181	BX8.5d	-	2	12	2800	White	10.2	1	50	-
2721MF	4050300891255	B8.5d	-	1.2	12	2800	White	6.4	1	50	-
2722MF	4008321096791	B8.5d	-	2	12	2800	White	10.2	1	50	-
828	4062172094283	PG18.5d-1	P13W	13	12	2800	White	250	1	50	-
3156	4008321090621	W2.5x16d	P27W	27	12	2800	White	402	1	50	-
3157	4052899183414	W2.5x16q	P27/7W	27/7	12	2800	White	402	1	50	-
3157A	4052899304291	W2.5x16q	-	27/7	12	2200	Amber	302/28	1	50	-
3757AK ¹⁾	4052899178731	WX2.5x16q	PY27/7W	27/7	12	2200	Amber	280/21	1	50	-
3796	4050300891309	BA9s	-	2	12	2800	White	12.5	1	50	-
5201	4052899600546	PG20-1	PS19W	19	12	2800	White	350	1	50	-
5202	4052899600584	PG20-1	PS24W	24	12	2800	White	500	1	50	-
2504	4052899600560	PG20-1	PSX24W	24	12	2800	White	500	1	50	-
6851	4062172160100	PG18.5d-3	PSX26W	26	12	2800	White	500	1	50	-

1) Amber light for clear indicator lights.

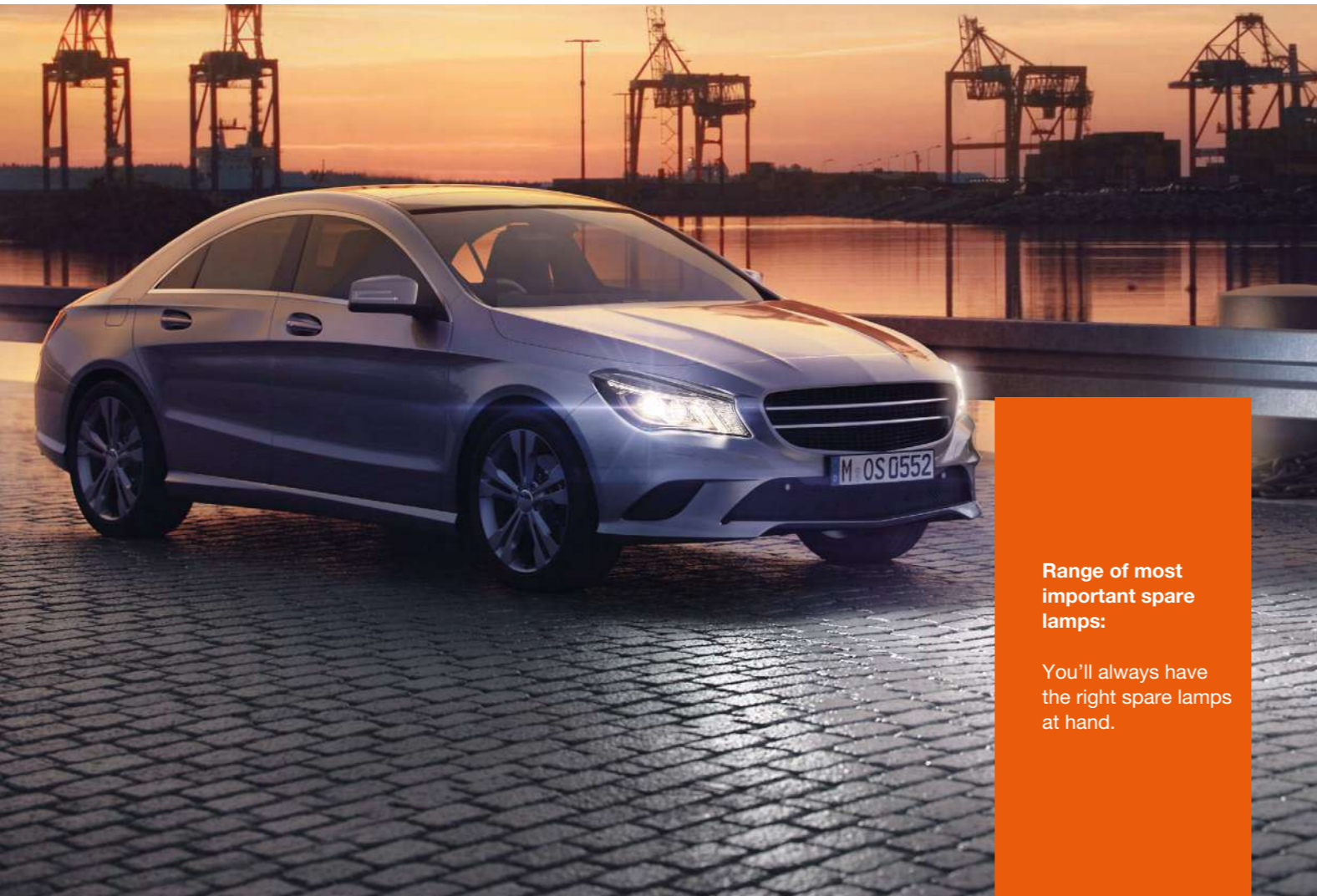

Range of most important spare lamps:

You'll always have the right spare lamps at hand.

8 MINIBOX

The cost-effective original spare parts

OSRAM ORIGINAL LINE halogen lamps offer convincing performance for standard requirements, are robust and cost-effective. They have already been successfully used in millions of new cars from renowned manufacturers, whether as standard initial equipment or original spare parts. Convince yourself of the excellent value for money, the reliable OEM quality and the wide product range of the ORIGINAL LINE.

Clear labeling and application illustration:
Easy identification.

Reserve light for cars:
Mandatory in many countries.

MINIBOX

Defects in a vehicle usually make themselves known on long journeys. The OSRAM MINIBOX saves you the trouble of searching for a suitable workshop to purchase replacement lamps. You can therefore easily fix the problem yourself.



Features

- Range of most important spare lamps
- Clear labeling and application illustration
- Original spare parts that exceed all ECE minimum standards

Benefits

- You'll always have the right spare lamps at hand
- Easy identification
- Premium quality made by OSRAM
- Mandatory in many countries

MINIBOX

Product Reference	EAN	ECE	W	V	COLOR	i		
CLK H1	4050300875217	H1	55	12	White	Headlight + five spare lamps and three flat fuses	1	10
CLK H4	4050300873398	H4	60/55	12	White	Headlight + five spare lamps and three flat fuses	1	10
CLK H7	4050300876375	H7	55	12	White	Headlight + five spare lamps and three flat fuses	1	10
CLK H1/H7	4052899522640	H1/H7	55	12	White	Headlight + five spare lamps and three flat fuses	1	10
All boxes								
7506		P21W	21	12	White	Brake and tail light		
7507 ¹⁾		PY21W	21	12	Amber	Indicator light, amber		
7528		P21/5W	21/5	12	White	Brake/tail light		
5007		R5W	5	12	White	Tail light and license plate light		
2825		W5W	5	12	White	Parking light 15 A, 20 A, 30 A flat fuses		

1) Amber light for clear indicator lights.



Please see 12 V car range which is fitting for motorcycles.

ORIGINAL SPARE PART

OEM Quality:
Tried and trusted in millions of vehicles of well-known manufacturers.

ORIGINAL MOTORCYCLE

Whether as standard initial equipment for motorcycles or as original spare parts, these lamps feature high quality and reliability. OSRAM ORIGINAL lamps have been tested for vibration resistance.



Features

- OEM Quality
- Original spare parts that exceed all ECE minimum standards
- Wide product range

Benefits

- Tried and trusted in millions of vehicles of well-known manufacturers
- Premium quality made by OSRAM
- Suitable for the most common headlights

ORIGINAL ORIGINAL MOTORCYCLE

Product Reference	EAN										
-------------------	-----	--	--	--	--	--	--	--	--	--	--

ORIGINAL – halogen lamps

64327	4052899136755	BA20d	S2	35/35	12	3200	White	650/465	1	100	-
64185	4050300439969	PX43t	HS1	35/35	12	3200	White	820/520	1	100	-

9 ORIGINAL MOTORCYCLE

The cost-effective original spare parts for motorcycles

OSRAM ORIGINAL LINE motorcycle lamps offer convincing performance for standard requirements, are robust and cost-effective. They have already been successfully used in millions of new vehicles from renowned manufacturers, whether as standard initial equipment or original spare parts. Convince yourself of the excellent value for money, the reliable OEM quality and the wide product range of the ORIGINAL LINE.

Premium quality:
Original spare parts that exceed all ECE minimum standards.

Wide product range:
Suitable for the most common headlights.

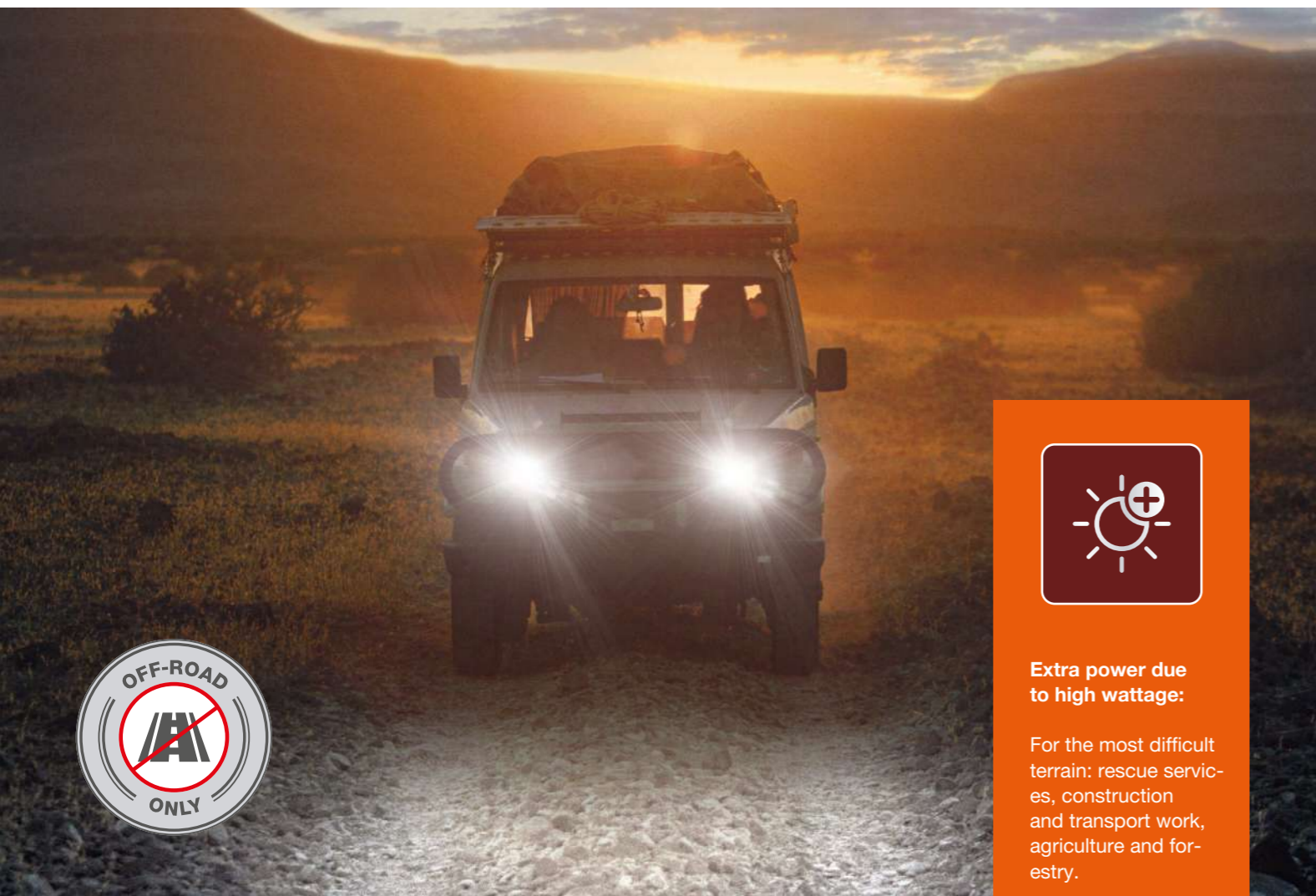

SUPER BRIGHT¹⁾ / SUPER BRIGHT PREMIUM¹⁾

With a strong portfolio of high-wattage off-road lamps with extra power, OSRAM provides solutions for even the most unusual requirements. All lamps are designed and designated for off-road use only and not permitted on public roads.



Features

- Extra power due to high wattage
- Excellent brightness
- Rugged and versatile

Benefits

- For the most difficult terrain: rescue services, construction and transport work, agriculture and forestry
- More light allows to see further and therefore react sooner
- Solution for even the most unusual requirements

SUPER BRIGHT PREMIUM / SUPER BRIGHT

Product Reference	EAN										
-------------------	-----	--	--	--	--	--	--	--	--	--	--

SUPER BRIGHT PREMIUM – halogen lamps

62200SBP	4052899126282	P14.5s	≙H1	100	12	3200	White	1150	1	100	-
62201SBP	4052899126312	PK22s	≙H3	100	12	3200	White	1600	1	100	-
62204SBP	4008321856357	P43t	≙H4	100/90	12	3200	White	1700/1075	1	100	-
62261SBP	4008321856388	PX26d	≙H7	80	12	3200	White	1500	1	100	-

SUPER BRIGHT – halogen lamps

64152SB	4050300222738	PX14.5s	≙H1	100	12	3200	White	1550	1	100	-
64153SB	4050300222837	PKY22s	≙H3	100	12	3200	White	1600	1	100	-

10 SUPER BRIGHT¹⁾ and SUPER BRIGHT PREMIUM¹⁾

The high-wattage off-road light with extra power

SUPER BRIGHT PREMIUM and SUPER BRIGHT are high-wattage off-road lamps with extra power. Those rugged and versatile lamps proved excellent brightness even on the most difficult terrain: rescue services, construction and transport work, agriculture and forestry. These products are not ECE-approved and must not be used on public roads in any exterior application. Use on public roads will invalidate both the operating license and insurance coverage. Some countries prohibit the sale and use of these products. Please contact your local distributor for information on your country.



Excellent brightness:

More light allows to see farther and therefore react sooner.



Rugged and versatile:

Solution for even the most unusual requirements.

¹⁾ These products do not have ECE approval and must not be used on public roads in any exterior application. Public roads use leads to cancellation of operating license and loss of insurance coverage. Several countries forbid sale and use of these products. Please contact your local distributor for further information.

¹⁾ These products do not have ECE approval and must not be used on public roads in any exterior application. Public roads use leads to cancellation of operating license and loss of insurance coverage. Several countries forbid sale and use of these products. Please contact your local distributor for further information.



Hyper white light for stylish LED look:

For fatigue-free and comfortable driving.

COOL BLUE® BOOST¹⁾

The COOL BLUE® BOOST product family convinces with hyper white light for LED look and high color temperatures. All lamps are designed and designated for off-road use only and not permitted on public roads.



Features

- Hyper white light for LED look
- Color temperatures of up to 5 500 K²⁾
- Enhanced brightness

Benefits

- Modern look
- High contrast
- More light allows to see farther and therefore react sooner

COOL BLUE® BOOST

Product Reference	EAN		ECE	W	V	K	COLOR	lm			GUAR-ANTEE (YEAR)
-------------------	-----	--	-----	---	---	---	-------	----	--	--	-------------------

COOL BLUE® BOOST – halogen lamps

62150CBB-2HB	4062172388047	P14.5s	≧H1	80	12	5500	White	1150	2	10	-
62193CBB-2HB	4062172388207	P43t	≧H4	100/90	12	5500	White	1600/760	2	10	-
62210CBB-2HB	4062172388221	PX26d	≧H7	80	12	5500	White	1000	2	10	-
62211CBB-2HB	4062172388245	PGJ19-2	≧H11	75	12	5500	White	1000	2	10	-

11 COOL BLUE® BOOST¹⁾

Hyper white light for LED look for off-road use

COOL BLUE® BOOST features hyper white halogen light for LED look and high color temperatures of up to 5 500 K. The lamps generate enhanced brightness. These products do not have ECE approval. This means they must not be used on public roads in any exterior application. Use on public roads leads to cancellation of operating license and loss of insurance coverage. Several countries do not allow sale and use of these products. Please contact your local distributor for information on the availability in your country.



Up to 5 500 K:¹⁾
High contrast and most stylish look.



Enhanced brightness:
More light allows to see farther and therefore react sooner.

¹⁾ These products do not have ECE approval and must not be used on public roads in any exterior application. Public roads use leads to cancellation of operating license and loss of insurance coverage. Several countries forbid sale and use of these products. Please contact your local distributor for further information.

¹⁾ These products do not have ECE approval and must not be used on public roads in any exterior application. Public roads use leads to cancellation of operating license and loss of insurance coverage. Several countries forbid sale and use of these products. Please contact your local distributor for further information. ²⁾ Measured in headlamps.

OSRAM Halogen Lamps – Measurements

(H1, \triangle H1)	(H3, \triangle H3)	(H4, \triangle H4)	(H7, \triangle H7)	(H8)	(H8B)	(P27W)	(P27/7W, 3157A)	(PY27/7W)	(PR21W)	(PR21/5W)	(PS19W)
(H9)	(H9B)	(H10)	(H11, \triangle H11)	(H11B)	(H13)	(PS24W)	(PSX24W)	(R5W, R10W, RY10W)	(T4W, 3860)	(W2.3W)	(W3W, 2820)
(H15)	H16)	(H18)	(H19)	(HB2)	(HB3)	(W5W, WY5W, 2886X)	(W16W)	(WY16W)	(W21W, WY21W)	(W21/5W)	(2341)
(HB3A)	(HB4)	(HB4A)	(HB5)	(HIR1)	(HIR2)	(2721, 2722, 2741)	(2840)	(3796)	(6411, 6413, 6421, 6424, 6429)	(6428, 6430)	(6438)
(H27W/1, H27W/2)	(S1, S2)	(HS1)	(\neq R2)			(6461)	(64111, 64113, 64115)	(2351MFX6)	(2352MFX6)	(2452MFX6)	(2473MFX6)
(C5W)	(H6W)	(H21W)	(HY21W)	(P21W, PY21W, 7529)	(P21/4W, P21/5W, 7240)	(2721MF)	(2721MFX)	(2722MF)	(2722MFX)	(2741MF, 2741MFX)	(828, 6851)



OSRAM-quality guaranteed

All OSRAM products are extensively stress tested by our quality assurance system. For information concerning guarantees, visit www.osram.com/am-guarantee or scan the QR code.

1

Inspection lights

The LEDinspect® range includes a variety of handheld, wearable, and mounted LED inspection lights.



2

Tyre care

Get the optimum performance from tyres, even in tough conditions. With our devices you can check, inflate and seal tyres, wherever and whenever you need to.



3

Battery care

With a range of BATTERYcharge, BATTERYtest, and BATTERYstart products to choose from, all your battery needs are taken care of.



4

Power inverters

Stay powered up on the road with our modified sine wave inverters.



5

Warning, safety and reading lights

Be ready for any roadside repair with the LEDguardian® warning and safety light range, and illuminate the vehicle interior with our reading lights.



Automotive Care & Equipment
Prepared for every journey



High power:
OSRAM lamps provide a brighter, uniform wide angle light output compared with conventional LEDs.

1 Inspection lights

Directing light exactly where needed

LEDinspect® PRO inspection lights are purpose-built for repairs and routine maintenance. Available in a variety of sizes and styles, from handheld and wearable to magnetic and hook-mounted lights, the range offers innovative solutions for every application. High-performance, long-lasting LEDs produce powerful cool-white light. And our ergonomic designs ensure light is delivered precisely where it's needed, illuminating the darkest corners and hard-to-reach areas.

IK09 Shock resistant:
IK09 is the maximum classification for protection provided by enclosures for electrical equipment against external impacts.

Multi-Positioning:
Allows you to easily direct light output exactly where you need it.

Hands-free:
Position light perfectly and easily using magnets, clips and hooks.

LEDinspect® WIRE-FREE PRO 600



LEDIL421

A bright inspection light with the possibility to simplify recharging via a magnetic charging pad.

Features

- Brightness: up to 600 lm (high), 100 lm (torch)
- Cool-white colour (up to 5 700 K)
- Multi-angle positioning: 180° flex
- Magnetic base, back and hanging hook
- Dust, water, and shock resistant
- Protection classes: IP65, IK08

Benefits

- Battery charge status indicator, USB-C cable included
- Battery life: up to 10 h on torch, 3 h on high, 2 h charging time
- Magnetic "Wire-Free" charging via charging pad
- 2-year guarantee¹⁾

LEDinspect® WIRE-FREE SLIM 600



LEDIL422

A bright inspection light with the possibility to simplify recharging via a magnetic charging pad.

Features

- Brightness: up to 600 lm (high), 100 lm (torch)
- Cool-white colour (up to 5 700 K)
- Multi-angle positioning: 180° flex and 270° twist
- Magnetic base, back and hanging hook
- Dust, water, and shock resistant
- Protection classes: IP65, IK08

Benefits

- Battery charge status indicator, USB-C cable included
- Battery life: up to 10 h on torch, 3 h on high, 2 h charging time
- Magnetic "Wire-Free" charging via charging pad
- 2-year guarantee¹⁾

LEDinspect® SINGLE CHARGE PAD



LEDIL423

A magnetic charging pad with one charge point to effortlessly charge one individual inspection light.

Features

- Wire-Free charging capability
- "Daisy Chain" function
- Different mounting options
- Powerful magnets
- One charging point to charge one product on a single base

Benefits

- Positive direct wire-free connection for charging
- Can link to another pad (single or duo) to charge more lamps
- Can attach to a wall or metal surface
- Can easily support inspection lamp on metal surface
- 2-year guarantee¹⁾

LEDinspect® DUAL CHARGE PAD



LEDIL424

A magnetic charging pad with two charge points to effortlessly charge two individual inspection lights.

Features

- Wire-Free charging capability
- "Daisy Chain" function
- Different mounting options
- Powerful magnets
- Two charging points to charge two products on a single base

Benefits

- Positive direct wire-free connection for charging
- Can link to another pad (single or duo) to charge more lamps
- Can attach to a wall or metal surface
- Can easily support inspection lamp on metal surface
- 2-year guarantee¹⁾

¹⁾ For precise conditions please refer to www.osram.com/am-guarantee.

LEDinspect® SLIM MAX 1000

This versatile, rechargeable work light with an integrated dimmer allows you to adjust the brightness level to your liking.

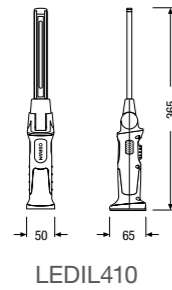

LEDIL410

Features

- Brightness: up to 1000 lm (high), 100 lm (low), 100 lm (torch)
- Cool-white colour (up to 6 000 K)
- Multi-angle positioning: 120° flexibility
- Magnetic base, back and hanging hook
- Dust, water, and shock resistant
- Protection classes: IP65, IK06

Benefits

- USB-C charging and charge status indicator
- Battery life: up to 10.5 h on low, 1.5 h on high
- 2-year guarantee¹⁾

LEDinspect® SLIM 500

An ultra-flat, rechargeable folding light with three settings (high, low, and flashlight) and a non-slip, dirt-repellent surface.

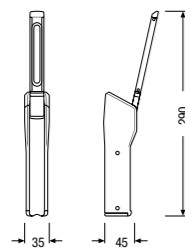

LEDIL403

Features

- Brightness: up to 500 lm (high), 250 lm (low), 70 lm (torch)
- Cool-white colour (up to 6 000 K)
- Multi-angle positioning: 180° flex and 270° twist
- Magnetic base and hanging hook
- Dust, water, and shock resistant
- Protection classes: IP54, IK07

Benefits

- USB-C charging and charge status indicator
- Battery life: up to 6 h on low, 3.5 h on high
- 2-year guarantee¹⁾

LEDinspect® POCKET 200

A slim and lightweight rechargeable light with foldable design for working in confined and hard-to-reach spaces.

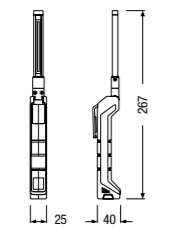

LEDIL408

Features

- Brightness: up to 200 lm (high), 80 lm (low), 40 lm (torch)
- Cool-white colour (up to 6 500 K)
- Multi-angle positioning: 180° flex and 360° twist
- Magnetic base
- Dust, water, and shock resistant
- Protection classes: IP20, IK07

Benefits

- USB-C charging and charge status indicator
- Battery life: up to 3 h on low, 1.5 h on high
- 2-year guarantee¹⁾

LEDinspect® MAX 500

A rechargeable light with two standard LED light settings as well as a UV torchlight setting for leak detection.

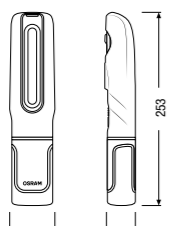

LEDIL402

Features

- Brightness: up to 500 lm (high), 250 lm (low)
- Cool-white colour (up to 6 000 K)
- Multi-angle positioning: 180° flex and 360° twist
- Magnetic base and hanging hook
- Dust, water, and shock resistant
- Protection classes: IP65, IK08

Benefits

- USB-C charging and charge status indicator
- Battery life: up to 7.5 h on low, 4.5 h on high
- UV-light function (1 LED + 1 UV LED)
- 2-year guarantee¹⁾

LEDinspect® MINI 250

A rechargeable light with three settings (high, low, and flashlight) and a non-slip, dirt-repellent surface.

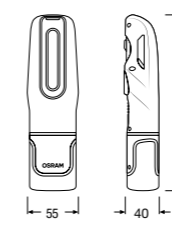

LEDIL401

Features

- Brightness: up to 250 lm (high), 130 lm (low), 70 lm (torch)
- Cool-white colour (up to 6 000 K)
- Multi-angle positioning: 180° flex
- Magnetic base and hanging hook
- Dust, water, and shock resistant
- Protection classes: IP65, IK06

Benefits

- USB-C charging and charge status indicator
- Battery life: up to 6 h on low, 3 h on high
- 2-year guarantee¹⁾

LEDinspect® TWIST 250

A lightweight and robust light with three output levels and twist function for full control over the direction of the light beam.

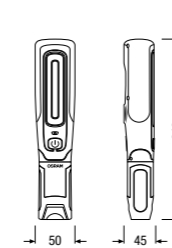

LEDIL412

Features

- Brightness: up to 250 lm (high), 125 lm (low), 80 lm (torch)
- Cool-white colour (up to 6 000 K)
- Multi-angle positioning: 120° flex and 360° twist
- Magnetic base, back and hanging hook
- Dust, water, and shock resistant
- Protection classes: IP20, IK09

Benefits

- Charging plug and cable included
- Battery life: up to 4 h on low, 3 h on high
- 2-year guarantee¹⁾

LEDinspect® UTILITY 1000

A multi-functional inspection light with varying output levels suitable for handheld, flood light, or underbonnet applications.

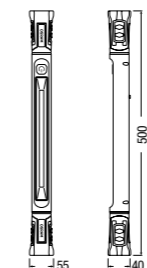

LEDIL407

Features

- Brightness: up to 1000 lm (high), 400 lm (low)
- Cool-white colour (up to 6 500 K)
- Multi-angle positioning: 180° flex and 360° twist
- Magnetic base, back and hanging hook
- Dust, water, and shock resistant
- Protection classes: IP20, IK07

Benefits

- 2 x charging plugs and charge status indicator
- Battery life: up to 5.5 h on low, 2.5 h on high
- 2-year guarantee¹⁾

LEDinspect® RECHARGEABLE UNDERBONNET LIGHT

An engine compartment light with rotating light bar, extendable mounting rod with soft padded feet, and lightweight design to avoid damage to vehicles.

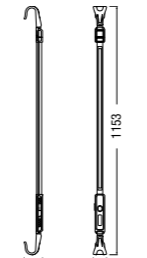

LEDIL415

Features

- Brightness: up to 1200 lm (high), 600 lm (low)
- Cool-white colour (up to 6 500 K)
- Multi-angle positioning: 360° lightbar rotation
- Extendable up to 1.8 m
- Dust, water, and shock resistant
- Protection classes: IP65, IK07

Benefits

- USB-C charging and charge status indicator
- Battery life: up to 4.5 h on low, 2 h on high
- 2-year guarantee¹⁾

¹⁾ For precise conditions please refer to www.osram.com/am-guarantee.

¹⁾ For precise conditions please refer to www.osram.com/am-guarantee.

LEDinspect® FLEXIBLE INSPECTION LIGHT

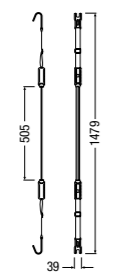

LEDIL416

A versatile inspection light, directing the light where needed. The light strip is fully flexible, allowing the light to bend around the workspace.

Features

- Brightness: up to 1000 lm (high), 400 lm (low) plus a red light option
- Multi-angle positioning: 160° twist
- Removable elasticated straps with hooks – extendable length up to 2.1 m
- Magnets offer more fixing options
- Dust, water, and shock resistant
- Protection classes: IP52, IK07

Benefits

- USB-C cable included
- Battery life: up to 20 h on low, 6.5 h on medium, 3 h high
- Flexible design
- 2-year guarantee¹⁾

LEDinspect® HEADTORCH 250

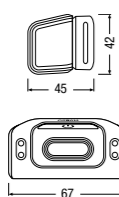

LEDIL404

A high-quality head lamp with two output levels, motion sensor, and adjustable strap with soft padding for optimal comfort.

Features

- Brightness: up to 250 lm (high), 140 lm (low)
- Cool-white colour (up to 5 700 K)
- Multi-angle positioning: 60° flex
- Dust, water, and shock resistant
- Protection classes: IP54, IK08

Benefits

- USB-C charging
- Battery life: up to 6 h on low, 3.5 h on high
- Integrated motion sensor technology
- 2-year guarantee¹⁾

LEDinspect® WEARABLE NECK LIGHT

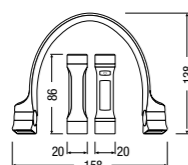

LEDIL413

A rechargeable neck light with two detachable torches, two light settings, and built-in magnet allows for convenient hands-free working.

Features

- Brightness: up to 265 lm (high), 130 lm (low)
- Cool-white colour (up to 6 500 K)
- Multi-angle positioning: 90° flex
- Built-in magnet for off-person mounting
- Dust, water, and shock resistant
- Protection classes: IP54, IK07

Benefits

- 2 x USB Micro B charging ports
- Battery life: up to 4.5 h on low, 3 h on high
- Separately powered torches with power button on each
- 2-year guarantee¹⁾

LEDinspect® FLEXIBLE HEAD TORCH

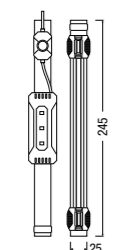

LEDIL414

A head lamp with two light levels, flashing red rear LED warning light for safety and flexible, foldable design for easy storage and transport.

Features

- Brightness: up to 115 lm (high), 50 lm (low) and flashing
- Cool-white colour (up to 6 000 K)
- Flexible and foldable
- Rear red warning light
- Dust, water, and shock resistant
- Protection classes: IP42, IK07

Benefits

- USB Micro B charging
- Battery life: up to 5.5 h on low, 4.5 h on high
- 2-year guarantee¹⁾

LEDinspect®

range



LEDinspect® WIRE-FREE PRO 600



LEDinspect® WIRE-FREE SLIM 600



LEDinspect® SINGLE CHARGE PAD



LEDinspect® DUAL CHARGE PAD

Name	LEDIL421	LEDIL422	LEDIL423	LEDIL424
Product number	LEDIL421	LEDIL422	LEDIL423	LEDIL424
EAN	4062172393126	4062172393140	4062172393164	4062172393188
No. of LED	1+1	1+1	N/A	N/A
Max lumen output (lm)	600	600	N/A	N/A
Min lumen output (lm)	N/A	N/A	N/A	N/A
Torch lumen output (lm)	100	100	N/A	N/A
Power supply	Magnetic Charge Pad, USB-C	Magnetic Charge Pad, USB-C	Magnetic Charge Pad, USB-C	Magnetic Charge Pad, USB-C
Operating time on max level (h)	Up to 3	Up to 3	N/A	N/A
Max operating time (h)	Up to 10	Up to 10	N/A	N/A
Charging time (h)	ca. 2.5	ok. 2.5	N/A	N/A
Dimming	No	No	N/A	N/A
IP rating	65	65	20	20
IK rating	08	08	08	08
Foldable	No	Yes	N/A	N/A
Adjustability	180° flex	180° flex 270° twist	N/A	N/A
Rechargeable	Yes	Yes	No	No
Charging equipment included	Lead	Lead	Lead	Lead
Product weight (g)	300	240	190	270
Battery type	Lithium	Lithium	N/A	N/A
Kelvin (K)	5700	5700	N/A	N/A

¹⁾ For precise conditions please refer to www.osram.com/am-guarantee.

LEDinspect® range												
Name	LEDinspect® SLIM MAX 1000	LEDinspect® SLIM 500	LEDinspect® POCKET 200	LEDinspect® MAX 500	LEDinspect® MINI 250	LEDinspect® TWIST 250	LEDinspect® UTILITY 1000	LEDinspect® RECHARGEABLE UNDERBONNET LIGHT	LEDinspect® FLEXIBLE INSPECTION LIGHT	LEDinspect® HEADTORCH 250	LEDinspect® WEARABLE NECK LIGHT	LEDinspect® FLEXIBLE HEAD TORCH
Product number	LEDIL410	LEDIL403	LEDIL408	LEDIL402	LEDIL401	LEDIL412	LEDIL407	LEDIL415	LEDIL416	LEDIL404	LEDIL413	LEDIL414
EAN	4062172355674	4052899623842	4052899623897	4052899623835	4052899623828	4052899623934	4062172338356	4052899631021	4062172405959	4062172354875	4052899630987	4052899630994
No. of LED	1+1	1+1	1+1	1+1 UV	1+1	1+1	1	32	1	1	1+1	1
Max lumen output (lm)	1000	500	200	500	250	250	1000	1200	1000	250	265	115
Min lumen output (lm)	100	250	80	250	130	125	400	600	100	140	130	50
Torch lumen output (lm)	100	70	40	N/A	70	80	N/A	N/A	N/A	N/A	Yes	Yes
Power supply	USB-C	USB-C	USB-C	USB-C	USB-C	DC Barrel Jack	USB-C	USB-C	USB-C	USB-C	USB Micro B	USB-C
Operating time on max level (h)	Up to 1.5	Up to 3.5	Up to 1.5	Up to 4.5	Up to 3	Up to 3	Up to 2.5	Up to 2	Up to 3	Up to 3.5	Up to 3	Up to 4.5
Max operating time (h)	Up to 10.5	Up to 6	Up to 3	Up to 7.5	Up to 6	Up to 4	Up to 5.5	Up to 4.5	Up to 20	Up to 6	Up to 4.5	Up to 5.5
Charging time (h)	ca. 3.5	ca. 3.5	ca. 2	ca. 5.5	ca. 3.5	ca. 4.5	ca. 5	ca. 3	ca. 7	ca. 3.5	ca. 1.5	ca. 1.5
Dimming	Yes	No	No	No	No	No	No	No	No	No	No	No
IP rating	65	54	20	65	65	20	20	65	52	54	54	42
IK rating	06	07	07	08	07	09	07	07	07	08	07	N/A
Foldable	No	Yes	Yes	No	No	No	No	No	Flexible	No	Yes	No
Adjustability	120° flex	180° flex 270° twist	180° flex 360° twist	180° flex 360° twist	180° flex	120° flex 360° twist	180° flex 360° twist	360° twist	160° twist on each handle	60° flex	90° flex	N/A
Rechargeable	Yes	Yes	Yes	Yes	Yes	Yes	Yes	Yes	Yes	Yes	Yes	Yes
Charging equipment included	No	Yes	Cable included	Yes	Yes	Yes	Yes	Yes	Yes	Yes	Yes	Yes
Product weight (g)	308	155	120	350	215	488	588	840	259	105	115	62
Battery type	Lithium	Lithium	Lithium	Lithium	Lithium	Lithium	Lithium	Lithium	Lithium	Lithium	Lithium	Lithium
Kelvin (K)	6000	6000	6500	6000	6000	6000	6500	6500	6200-6500	5700	6500	6000



Flexibility:

Portable tyre inflators are handy, light and, thanks to their compact dimensions, easy to store and transport.

TYREinflate

Handling the pressure of tyre maintenance

Tyres are the only point of contact a vehicle has with the road. It is vital that they are looked after correctly, providing optimum road handling and improved safety.

Ensuring the tyres are inflated to the correct pressure is an important part of regular tyre maintenance. Driving with low tyre pressure causes reduced vehicle control, 10% reduced tyre life and increased fuel costs. OSRAM's portable tyre inflators allow for at home and on the road, easy-to-use accurate tyre inflation.



2 Tyre care

Portable compressors and sealants for at home and on the go

With the tyre inflators from OSRAM, maintaining car tyres is easier than ever. Drivers can now quickly and easily check the pressure of their tyres themselves and adjust it if necessary. Maintaining tyre pressure regularly helps keeping control of the vehicle on the road. Furthermore, the optimal tyre pressure prevents increased abrasion and can therefore prolong the replacement cycles for tyres.



Wind-up cable:

Winding / unwinding mechanism for a neatly rolled up cable.



No tools required:

Inflate your tyres quickly and easily.



Including adaptors kit:

To inflate bicycles, balls and other inflatables.



TYREseal

Be back on the road within 10 minutes

The tyres, as the only point of contact of a car with the road, are susceptible to tyre punctures from time to time. While many cars are equipped with a spare tyre to help you get back on the road, more and more cars are supplied with sealant repair kits.

In fact, up to 22% of cars manufactured in 2019 were delivered with tyre sealant repair kits.

By fitting a tyre sealant kit instead of a tyre, the car manufacturer gains more space and can reduce the overall weight thereby reducing fuel consumption and protecting the environment. In most cases, it is also more convenient for drivers to use a tyre sealant kit than to change a tyre, as no tools or jack are needed.

TYREinflate 200

An analogue tyre inflator suitable to inflate a 13" tyre in 4.5 minutes.¹⁾

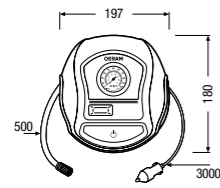

OTI200

Features

- 50 mm analogue pressure gauge
- Inflates a tyre from flat in 4.5 minutes¹⁾
- Valve cap storage compartment
- Flexible 50 cm air hose with easy access storage
- 3 m long wind-up power cable with fused 12 V DC plug

Benefits

- Easy to read with clear range indicator of the most common tyre pressures
- Complete with three-piece adaptor kit to inflate bicycles, balls and other inflatables
- Securely storing valve caps during inflation
- Designed to reduce kinks, preventing unnecessary wear and tear
- 2-year guarantee²⁾

TYREinflate 400

A digital tyre inflator suitable to inflate a 13" tyre in 3.5 minutes.¹⁾

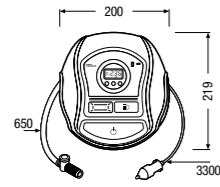

OTI400

Features

- Digital display with memory setting showing pressure readings in BAR, kPA and PSI
- Inflates a tyre from flat in 3.5 minutes¹⁾
- Valve cap storage compartment
- Flexible 50 cm air hose with easy access storage
- 3 m long wind-up power cable with fused 12 V DC plug

Benefits

- Improved reading or pressure settings with illumination in dark environments
- Complete with three-piece adaptor kit to inflate bicycles, balls and other inflatables
- Securely storing valve caps during inflation
- Designed to reduce kinks, preventing unnecessary wear and tear
- 2-year guarantee²⁾

TYREinflate 450

A digital tyre inflator with auto-stop suitable to inflate a 13" tyre in 3.5 minutes.¹⁾

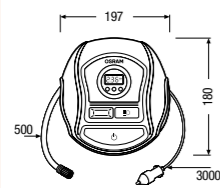

OTI450

Features

- Digital display with memory setting showing pressure readings in BAR, kPA and PSI
- Inflates a tyre from flat in 3.5 minutes¹⁾
- Auto-Stop function and valve cap storage compartment
- Flexible 50 cm air hose with easy access storage
- 3 m long wind-up power cable with fused 12 V DC plug

Benefits

- Improved reading or pressure settings with illumination in dark environments
- Complete with three-piece adaptor kit to inflate bicycles, balls and other inflatables
- Stops inflating when target pressure reached
- Designed to reduce kinks, preventing unnecessary wear and tear
- 2-year guarantee²⁾

TYREinflate 1000

A digital tyre inflator with auto-stop suitable to inflate a 13" tyre in 2 minutes.¹⁾

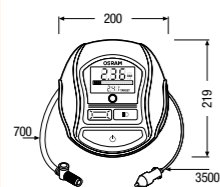

OTI1000

Features

- Digital display with status bar and memory setting showing pressure readings in BAR, kPA and PSI
- Inflates a tyre from flat in 2 minutes¹⁾
- Auto-Stop function and valve cap storage compartment
- Flexible 70 cm air hose with easy access storage
- 3.5 m long wind-up power cable with fused 12 V DC plug

Benefits

- Improved reading or pressure settings with illumination in dark environments
- Complete with three-piece adaptor kit to inflate bicycles, balls and other inflatables
- Stops inflating when target pressure reached
- Designed to reduce kinks, preventing unnecessary wear and tear
- 2-year guarantee²⁾

TYREinflate 2000

A digital, cordless and rechargeable tyre inflator with auto-stop suitable to inflate a bicycle tyre in 2 minutes.¹⁾

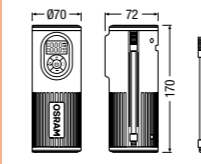

OTIR2000

Features

- Digital display with memory setting showing pressure readings in BAR, kPA and PSI
- Inflates a tyre from flat in 2 minutes¹⁾
- Auto-Stop function
- Flexible 14.5 cm air hose with easy access storage
- Rechargeable via USB power cable

Benefits

- Improved reading or pressure settings with illumination in dark environments
- Complete with two-piece adapter set, bike mount and storage bag
- Stops inflating when target pressure reached
- Designed to reduce kinks, preventing unnecessary wear and tear
- 2-year guarantee²⁾

TYREinflate 4000

A digital, cordless and rechargeable tyre inflator with auto-stop suitable to inflate a 13" tyre in 3.5 minutes.³⁾

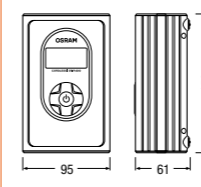

OTIR4000

Features

- Digital display with memory setting showing pressure readings in BAR, kPA and PSI
- Inflates a tyre from flat in 3.5 minutes³⁾
- Auto-Stop function
- Flexible 60 cm air hose with easy access storage
- Rechargeable via USB power cable

Benefits

- Improved reading or pressure settings with illumination in dark environments
- Complete with three-piece adaptor kit to inflate bicycles, balls and other inflatables
- Stops inflating when target pressure reached
- Designed to reduce kinks, preventing unnecessary wear and tear
- 2-year guarantee²⁾

TYREinflate 6000

A digital, cordless and rechargeable tyre inflator with auto-stop suitable to inflate a 13" tyre in 2 minutes.³⁾

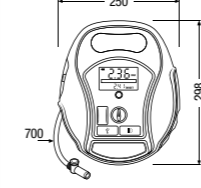

OTIR6000

Features

- Digital display with status bar and memory setting showing pressure readings in BAR, kPA and PSI
- Inflates a tyre from flat in 2 minutes³⁾
- Auto-Stop function and valve cap storage compartment
- Flexible 70 cm air hose with easy access storage
- 3.5 m long power cable with fused 12 V DC plug and additional 230 V AC power cable included for recharging

Benefits

- Improved reading or pressure settings with illumination in dark environments
- Complete with 10-piece adaptor kit, 4 spare valve caps, 1 spare fuse and 1 pair of gloves
- Stops inflating when target pressure reached
- Designed to reduce kinks, preventing unnecessary wear and tear
- 2-year guarantee²⁾

TYREinflate 830

A digital tyre inflator with auto-stop suitable to inflate a 13" tyre in 2 minutes or a 22" tyre in 5 minutes.^{1) 4)}

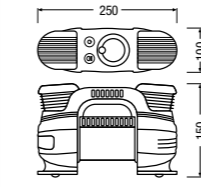

OTI830

Features









- Digital display with status bar and memory setting showing pressure readings in BAR, kPA and PSI
- Inflates a tyre from flat in 2 minutes¹⁾ / 5 minutes⁴⁾
- Auto-Stop function
- Flexible 85 cm air hose with easy access storage
- 4 m long power cable with fused 12 V DC plug

Benefits

- Improved reading or pressure settings with illumination in dark environments
- Absolute versatility for use on bikes, air beds and various other inflatables
- Stops inflating when target pressure reached
- Designed to reduce kinks, preventing unnecessary wear and tear
- 2-year guarantee²⁾

¹⁾ Measurements of the tyre pressure and inflation of the tyres to the optimum tyre pressure must always be conducted on cold tyres. Inflation time guide based on inflating a 13" tyre to 2.4 BAR.
²⁾ For precise conditions please refer to www.osram.com/am-guarantee.

¹⁾ Inflation time based on a bicycle tyre from 0 to 5.5 BAR. ²⁾ For precise conditions please refer to www.osram.com/am-guarantee. ³⁾ Measurements of the tyre pressure and inflation of the tyres to the optimum tyre pressure must always be conducted on cold tyres. Inflation time guide based on inflating a 13" tyre to 2.4 BAR. ⁴⁾ Measurements of the tyre pressure and inflation of the tyres to the optimum tyre pressure must always be conducted on cold tyres. Inflation time guide based on inflating a 22" tyre to 2.6 BAR.

TYREinflate range								
	TYREinflate 200	TYREinflate 400	TYREinflate 450	TYREinflate 1000	TYREinflate 2000	TYREinflate 4000	TYREinflate 6000	TYREinflate 830
Name	TYREinflate 200	TYREinflate 400	TYREinflate 450	TYREinflate 1000	TYREinflate 2000	TYREinflate 4000	TYREinflate 6000	TYREinflate 830
Product number	OTI200	OTI400	OTI450	OTI1000	OTIR2000	OTIR4000	OTIR6000	OTI830
EAN	4052899 620209	40621724 04617	4052899 620216	4052899 620223	4062172 198769	4062172 306294	4062172 294515	4062172 294492
Display type	Large Analogue	Digital	Digital	Large Digital	Large Digital	Large Digital	Large Digital	Digital
Inflation time	4.5 mins ¹⁾	3.5 mins ¹⁾	3.5 mins ¹⁾	2 mins ¹⁾	2 mins ²⁾	3.5 mins ¹⁾	2 mins ¹⁾	2 mins ¹⁾
Auto-Stop function	No	No	Yes	Yes	Yes	Yes	Yes	Yes
Light	No	Yes	Yes	Yes	Yes	Yes	Yes	Yes
Power supply (V)	12	12	12	12	3,7 V Li-Ion Battery	7,4 V Li-Ion Battery	12 V & Li-Ion Battery	12
Wind up cable	Yes	Yes	Yes	Yes	No	No	No	No
Case	No	No	No	Yes	Yes	Yes	Yes	Yes
Gloves & spare dust caps	No	No	No	Yes	No	No	Yes	No
Adapters	Yes	Yes	Yes	Yes	Yes	Yes	Yes	Yes

1) Measurements of the tyre pressure and inflation of the tyres to the optimum tyre pressure must always be conducted on cold tyres. Inflation time guide based on inflating a 13" tyre to 2.4 BAR.

1) Measurements of the tyre pressure and inflation of the tyres to the optimum tyre pressure must always be conducted on cold tyres. Inflation time guide based on inflating a 13" tyre to 2.4 BAR.
2) Inflation time based on a bicycle tyre from 0 to 5.5 BAR.

TYREseal KIT

A tyre sealant kit including a 450 ml TYREseal bottle as well as an analogue tyre inflator and handy storage case.

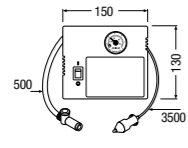

OTSK4

Features

- Flat tyre repair kit with sealant, tyre inflator & storage case
- TPMS (Tyre Pressure Monitoring System) safe
- Made to OE specification
- No tools required – no need to remove the valve core
- Can seal punctures up to 6 mm wide¹⁾

Benefits

- Quick seal solution – be on the road in 10 minutes
- Perfect replacement for the original kit that came with the vehicle
- Drive for up to 200 km
- Made with Particle Gel Sealant technology
- 2-year guarantee²⁾

TYREseal 450



OTSB450

A flat tyre sealant suitable to be used with most tyre inflators.

Features

- TPMS (Tyre Pressure Monitoring System) safe
- Made to OE specification
- No tools required – no need to remove the valve core
- Can seal punctures up to 6 mm wide¹⁾

Benefits

- Quick seal solution – be on the road in 10 minutes
- Perfect replacement for the original sealant that came with the vehicle
- Drive for up to 200 km
- Made with Particle Gel Sealant technology
- 2-year guarantee²⁾

TYREseal KIT ESSENTIAL

A tyre sealant kit including a 450 ml TYREseal bottle as well as an analogue tyre inflator and handy storage case.

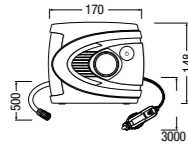

OTSK6ESN

Features

- Flat tyre repair kit with sealant, tyre inflator & storage case
- TPMS (Tyre Pressure Monitoring System) safe
- Made to OE specification
- No tools required – no need to remove the valve core
- Can seal punctures up to 6 mm wide¹⁾

Benefits

- Quick seal solution – be on the road in 10 minutes
- Perfect replacement for the original kit that came with the vehicle
- Drive for up to 200 km
- Made with Particle Gel Sealant technology
- 2-year guarantee²⁾

TYREseal ESSENTIAL

A flat tyre sealant suitable to be used with most tyre inflators.

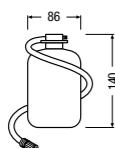

OTS4502ESN

Features

- TPMS (Tyre Pressure Monitoring System) safe
- Made to OE specification
- No tools required – no need to remove the valve core
- Can seal punctures up to 6 mm wide¹⁾

Benefits

- Quick seal solution – be on the road in 10 minutes
- Perfect replacement for the original sealant that came with the vehicle
- Drive for up to 200 km
- Made with Particle Gel Sealant technology
- 2-year guarantee²⁾

TYREseal

range



Name

TYREseal KIT

TYREseal 450

TYREseal KIT ESSENTIAL

TYREseal ESSENTIAL

Product number

OTSK4

OTSB450

OTSK6ESN

OTS4502ESN

EAN

4052899620247

4052899620230

4052899632363

4052899632370

Display type

Analogue

N/A

Analogue

N/A

Inflation time

4.5 mins¹⁾

N/A

4.5 mins¹⁾

N/A

Capacity (ml)

N/A

450

N/A

450

Made to OE specification

Yes

Yes

Yes

Yes

1) The tyre sealant cannot be used to repair damage to the sidewall of a tyre. 2) For precise conditions please refer to www.osram.com/am-guarantee.

1) Measurements of the tyre pressure and inflation of the tyres to the optimum tyre pressure must always be conducted on cold tyres. Inflation time guide based on inflating a 13" tyre to 2.4 BAR.



Start/Stop compatible:

Suitable for vehicles with Start/Stop system.

BATTERYcharge

Keeping vehicle batteries charged and ready

Automotive batteries require regular maintenance. This is especially true for cars that are not driven daily or stand parked for long periods of time, as power is discharged continuously when not in use – particularly in the cold winter months. Performing a routine inspection at least once a month can help maximize service life so you're always ready for the road.

Keep your battery charged at optimum levels with our range of premium-quality battery charging and maintenance devices. Whether with our smart chargers, solar power battery maintainers or charging cables for electric vehicles, your battery will stay in peak condition year-round.

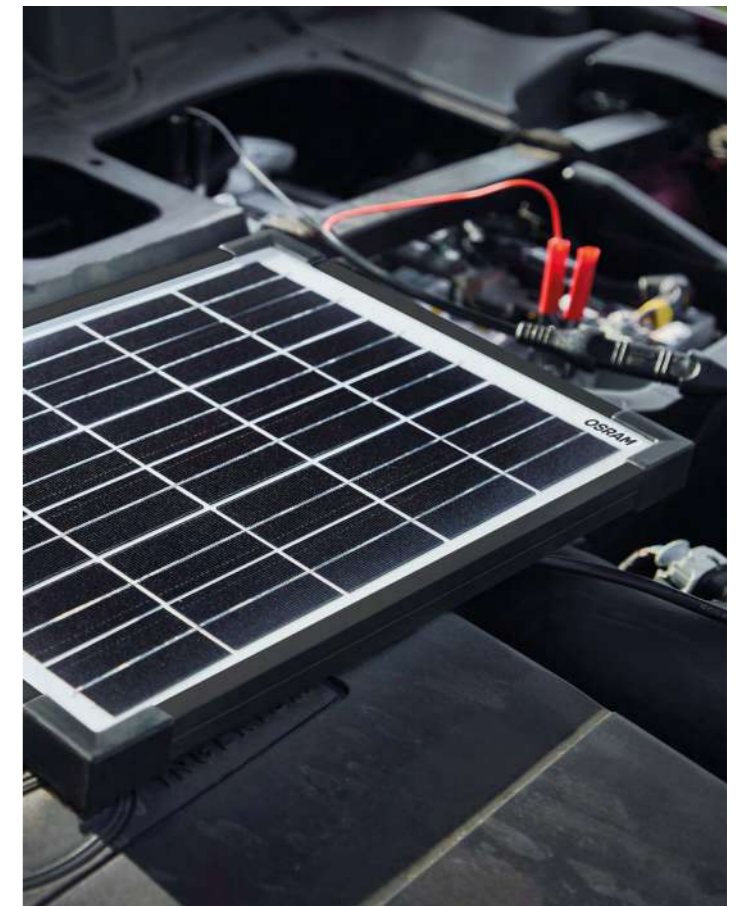

3 Battery care

Quality chargers, testers, and starters

Our OSRAM BATTERYcare product range provides the ideal conditions for a vehicle's battery. Given the advanced electronic systems in modern cars, you need high-quality chargers and sophisticated diagnostic equipment that you can rely on. Our BATTERYcharge, BATTERYtest, and BATTERYstart products cover a wide range of battery care and maintenance applications, for both 12 V and 24 V vehicles.



Rapid recharge:
A battery charging mode that reaches full charge in a few minutes.



Winter mode:
OSRAM BATTERYcharge products protect batteries at low temperatures.



Versatile:
Suitable for a wide range of battery types, including lithium, as well as for batteries in electric and hybrid vehicles.



BATTERYstart

The power to handle many situations

It's cold, you're late, and your car won't start – for most drivers, it's an all too familiar feeling. Whether caused by freezing temperatures, parking for extended periods or leaving your lights on, a dead battery always causes frustration. Don't let a dead battery spoil your day.

Our range of battery starters puts the power in your hands, so you can prevent being caught off-guard and unprepared.

BATTERYcharge 901

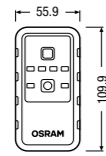

OEBCS901

A 1 A smart battery charger and maintainer suitable for providing power to recharge smaller batteries.

Features

- 1 A charging capacity
- Plugs directly into 230 V socket
- For 6 V and 12 V vehicles – ability to select the voltage to match the vehicle
- Up to 1.2 l engine size
- Start/Stop compatible

Benefits

- Automatically adjusts to long-term maintenance mode when battery is full
- 9 Stage charging process for Lead Acid/AGM, 7 Stage Lithium charge profile
- Clamps or O-Rings included in scope of supply for long term connection and difficult to access areas
- Reverse polarity and short-circuit protection
- 2-year guarantee¹⁾

BATTERYcharge 904

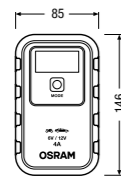

OEBCS904

A 4 A smart battery charger and maintainer suitable for providing power to recharge smaller batteries.

Features

- 4 A charging capacity with up to 2 A or 4 A charge rate selection
- Plugs directly into 230 V socket
- For 6 V and 12 V vehicles – ability to select the voltage to match the vehicle
- 90 Ah charging and 140 Ah maintenance mode – perfect for most motorbikes and small engine vehicles
- Start/Stop compatible

Benefits

- Automatically adjusts to long-term maintenance mode when battery is full
- 9 Stage charging process for Lead Acid/AGM, 7 Stage Lithium charge profile
- Clamps or O-Rings included in scope of supply for long term connection and difficult to access areas
- Reverse polarity and short-circuit protection
- 2-year guarantee¹⁾

BATTERYcharge 906

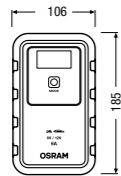

OEBCS906

A 6 A smart battery charger and maintainer suitable for providing power to recharge larger batteries.

Features

- 6 A charging capacity with up to 3 A or 6 A charge rate selection
- Plugs directly into 230 V socket
- For 6 V and 12 V vehicles – ability to select the voltage to match the vehicle
- 110 Ah charging and 160 Ah maintenance mode – suitable for most cars and vans
- Start/Stop compatible

Benefits

- Automatically adjusts to long-term maintenance mode when battery is full
- 9 Stage charging process for Lead Acid/AGM, 7 Stage Lithium charge profile
- Clamps or O-Rings included in scope of supply for long term connection and difficult to access areas
- Reverse polarity and short-circuit protection
- 2-year guarantee¹⁾

BATTERYcharge 908

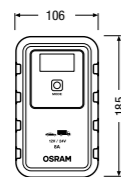

OEBCS908

A 8 A smart battery charger and maintainer suitable for providing power to recharge larger batteries.

Features

- 8 A charging capacity with up to 4 A or 8 A charge rate selection
- Plugs directly into 230 V socket
- For 12 V and 24 V vehicles – ability to select the voltage to match the vehicle
- 12 V up to 150 Ah charging and 24 V up to 70 Ah charging – suitable for most cars, vans and small trucks
- Start/Stop compatible

Benefits

- Automatically adjusts to long-term maintenance mode when battery is full
- 9 Stage charging process for Lead Acid/AGM, 7 Stage Lithium charge profile
- Clamps or O-Rings included in scope of supply for long term connection and difficult to access areas
- Reverse polarity and short-circuit protection
- 2-year guarantee¹⁾

BATTERYcharge

range



Name	BATTERYcharge 901	BATTERYcharge 904	BATTERYcharge 906	BATTERYcharge 908
Product number	OEBCS901	OEBCS904	OEBCS906	OEBCS908
EAN	4062172248563	4052899620520	4052899620537	4052899620544
Charge Rate (Up to)	1 Amps	4 Amps	6 Amps	8 Amps
Maintenance Charge (Up to)	1 Amps	2 Amps	3 Amps	4 Amps
Max battery size for charging 12 V	25 Ah	90 Ah	110 Ah	150 Ah
Max battery size for charging 24 V	x	x	x	70 Ah
Recommended to use with	Motorcycle, Car	Motorcycle, Car	Motorcycle, Car, SUV, Van	Motorcycle, Car, SUV, Van, Small Truck
Auto-Stop function	Yes	Yes	Yes	Yes
Stages: Lithium	7	7	7	7
Stages: Lead, AGM, EFB	9	9	9	9

¹⁾ For precise conditions please refer to www.osram.com/am-guarantee.

BATTERYcharge SOLAR 5W

A 5 W solar panel to maintain the vehicle's battery, perfect for vehicles that remain idle for extended periods.



Features

- Micro crystalline cell solar panels in robust aluminium frame
- Provides up to 5 W of free solar power to maintain your battery
- Superior efficient power performance to amorphous cell models
- 12 V battery charging
- Voltage (@Pmax) 18 V / Current (@Pmax) 0.28 A

Benefits

- Polarity protection
- Works best in direct sunlight but can work in sufficient daylight in overcast conditions
- IP65 Water resistant
- Supplied with 3 m length cable, 12 V DC power plug and battery clips
- 2-year guarantee¹⁾

BATTERYcharge SOLAR 10W

A 10 W solar panel to maintain the vehicle's battery, perfect for vehicles that remain idle for extended periods.



Features

- Micro crystalline cell solar panels in robust aluminium frame
- Provides up to 10 W of free solar power to maintain your battery
- Superior efficient power performance to amorphous cell models
- 12 V battery charging
- Voltage (@Pmax) 18 V / Current (@Pmax) 0.56 A

Benefits

- Polarity protection
- Works best in direct sunlight but can work in sufficient daylight in overcast conditions
- IP65 Water resistant
- Supplied with 3 m length cable, 12 V DC power plug and battery clips
- 2-year guarantee¹⁾

BATTERYcharge SOLAR 20W

A 20 W solar panel to maintain the vehicle's battery, perfect for vehicles that remain idle for extended periods.



Features

- Micro crystalline cell solar panels in robust aluminium frame
- Provides up to 20 W of free solar power to maintain your battery
- Superior efficient power performance to amorphous cell models
- 12 V battery charging
- Voltage (@Pmax) 18 V / Current (@Pmax) 1.11 A

Benefits

- Polarity protection
- Works best in direct sunlight but can work in sufficient daylight in overcast conditions
- IP65 Water resistant
- Supplied with 3 m length cable, 12 V DC power plug and battery clips
- 2-year guarantee¹⁾

BATTERYcharge Cable

A 2 m long cable for easy access to OBDII port.



Features

- Connects your solar panel to your battery via your vehicles OBDII port
- More efficient connection between solar panel and battery
- 2 A fuse
- UV Resistant cable
- Provides a permanent "On" link between a solar panel and your battery for long-term battery maintenance

Benefits

- Suitable for use with all OSRAM solar panels
- Easy to install
- Durable cable for long life
- 2-year guarantee¹⁾

BATTERYcharge SOLAR

range



Name	BATTERYcharge SOLAR 5W	BATTERYcharge SOLAR 10W	BATTERYcharge SOLAR 20W	BATTERYcharge SOLAR Cable
Product number	OSP500	OSP1000	OSP2000	OSPOBD
EAN	4062172404532	4062172404556	4062172404570	4062172404594
Wattage (W)	5	10	20	N/A
Voltage (@Pmax) (V)	18	18	18	N/A
Ampage (@Pmax) (A)	0.28	0.56	1.11	N/A
Polarity Protection	Yes	Yes	Yes	Yes
Cable length (m)	3	3	3	2

¹⁾ For precise conditions please refer to www.osram.com/am-guarantee.

BATTERYcharge
7PIN | 1PHASE | 16 AMP

A 1-phase, 16 A charging cable for electric vehicles.



Features

- 1-phase
- Type 2 to Type 2 connection
- Charging power 16 A up to 3.6 kWh
- Length 5 m
- Handles equipped with protection caps to prevent dust and water ingress
- Protection classes: IP65, IK10

Benefits

- Compliant for fully electric vehicles and for plug in hybrid vehicles
- Resistant and robust, with EVA case for easy transport, storage and protection against damage
- Up to 20 000 hours life cycle
- 2-year guarantee¹⁾

BATTERYcharge
7PIN | 1PHASE | 32 AMP

A 1-phase, 32 A charging cable for electric vehicles.



Features

- 1-phase
- Type 2 to Type 2 connection
- Charging power 32 A up to 7.2 kWh
- Length 5 m
- Handles equipped with protection caps to prevent dust and water ingress
- Protection classes: IP65, IK10

Benefits

- Compliant for fully electric vehicles and for plug in hybrid vehicles
- Resistant and robust, with EVA case for easy transport, storage and protection against damage
- Up to 20 000 hours life cycle
- 2-year guarantee¹⁾

BATTERYcharge
7PIN | 3PHASE | 32 AMP

A 3-phase, 32 A charging cable for electric vehicles.



Features

- 3-phase
- Type 2 to Type 2 connection
- Charging power 32 A up to 22 kWh
- Length 5 m
- Handles equipped with protection caps to prevent dust and water ingress
- Protection classes: IP65, IK10

Benefits

- Compliant for fully electric vehicles and for plug in hybrid vehicles
- Resistant and robust, with EVA case for easy transport, storage and protection against damage
- Up to 20 000 hours life cycle
- 2-year guarantee¹⁾

BATTERYcharge
7PIN | PORTABLE | 6/10/16 AMP

A portable, 6/10/16 A charging cable for electric vehicles to use without a wall box.



Features

- Compatible with a 2-PIN socket using the Schuko plug – charge wherever you have access to a 230 V socket
- Type 2 to Type 2 connection
- Variable charging currents of 6 A/10 A/16 A and rates of 1.3/2.2/3.6 kWh
- Length 5 m
- Handles equipped with protection caps to prevent dust and water ingress
- Protection classes: IP65, IK10

Benefits

- Compliant for fully electric and plug-in hybrid vehicles
- Resistant and robust, with EVA case for easy transport, storage and protection against damage
- Up to 20 000 hours life cycle
- 2-year guarantee¹⁾

BATTERYcharge
Charging cables for electric vehicles

range



Name	BATTERYcharge 7PIN 1PHASE 16 AMP	BATTERYcharge 7PIN 1PHASE 32 AMP	BATTERYcharge 7PIN 3PHASE 32 AMP	BATTERYcharge 7PIN PORTABLE 6/10/16 AMP
Product number	OCC21605	OCC23205	OCC23P05	OPC20A05
EAN	4052899624115	4052899624122	4052899624139	4052899624092
Current (A)	16	32	32	6/10/16
Max power (kW)	3.6	7.2	22	3.6
Voltage (V)	240	240	480	240
Number of phases	1	1	3	1
Vehicle charger type	Type 2	Type 2	Type 2	Type 2
Charging point charger type	Type 2	Type 2	Type 2	230 V Main Plug
Length (m)	5	5	5	5
Life time (up to h)	20 000	20 000	20 000	20 000

¹⁾ For precise conditions please refer to www.osram.com/am-guarantee.

**BATTERYstart
200**

Compact and powerful lithium jump starter with power bank feature to jump start vehicles with up to 3 l (petrol).

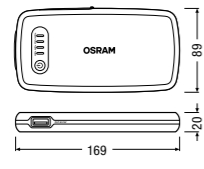

OBSL200

Features

- A compact lithium starter – easy to carry, use and store
- 6 000 mAh battery – for small to medium cars and vans up to 3 l (petrol)
- Power bank function, fast charging USB – charge a device on the go
- 2 h recharge time – have fully charged and ready to use quickly

Benefits

- Reverse polarity, short circuit and anti-spike protection
- Includes integrated LED torch with flashing function to attract attention or to illuminate engine bay in low light conditions or at night
- Intelligent clamps safely manage power between the jump starter and vehicle
- 2-year guarantee¹⁾

**BATTERYstart
300**

Compact and powerful lithium jump starter with power bank feature to jump start vehicles with up to 6 l (petrol) and 3 l (diesel).

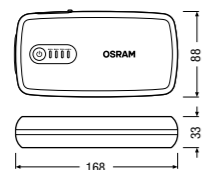

OBSL300

Features

- A compact lithium starter – easy to carry, use and store
- 13 000 mAh battery – for small to medium cars and vans up to 6 l (petrol) and 3 l (diesel)
- Power bank function, 2 x USB charging sockets – charge 2 devices on the go
- 3 h recharge time – have fully charged and ready to use quickly
- 4 cell lithium battery – delivers a higher starting voltage

Benefits

- Reverse polarity, short circuit and anti-spike protection
- Includes integrated LED torch with flashing function to attract attention or to illuminate engine bay in low light conditions or at night
- Intelligent clamps safely manage power between the jump starter and vehicle
- 2-year guarantee¹⁾

**BATTERYstart
400**

Compact and powerful lithium jump starter with power bank feature to jump start vehicles with up to 8 l (petrol) and 4 l (diesel).

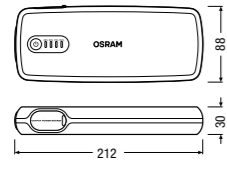

OBSL400

Features

- A compact lithium starter – easy to carry, use and store
- 16 800 mAh battery – for small to medium cars and vans up to 8 l (petrol) and 4 l (diesel)
- Power bank function, 2 x USB charging sockets – charge 2 devices on the go
- 4 h recharge time – have fully charged and ready to use quickly
- 12 V socket output – power 12 V products for leisure and work

Benefits

- Reverse polarity, short circuit and anti-spike protection
- Includes integrated LED torch with flashing function to attract attention or to illuminate engine bay in low light conditions or at night
- Intelligent clamps safely manage power between the jump starter and vehicle
- 2-year guarantee¹⁾

**BATTERYjumpstart
500**

Compact and powerful lithium jump starter with "boost"-function for fully discharged batteries to jump start vehicles with up to 3 l (petrol) and 1.5 l (diesel) from flat.

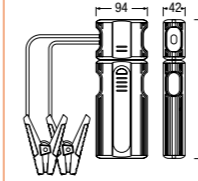

OJS010

Features

- A compact lithium starter – easy to carry, use and store
- 6 000 mAh battery – for small to medium cars and vans up to 3 l (petrol) and 1.5 l (diesel)
- Power bank function, fast charging USB – charge a device on the go
- Integrated "controlled start" boost – jump start batteries from 0V

Benefits

- Reverse polarity, short circuit and anti-spike protection
- Includes integrated LED torch with flashing function to attract attention or to illuminate engine bay in low light conditions or at night
- Intelligent clamps safely manage power between the jump starter and vehicle
- 2-year guarantee¹⁾

**BATTERYjumpstart
1000**

Compact and powerful lithium jump starter with "boost"-function for fully discharged batteries to jump start vehicles with up to 5 l (petrol) and 2 l (diesel) from flat.

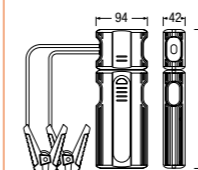

OJS020

Features

- A compact lithium starter – easy to carry, use and store
- 8 000 mAh battery – for small to medium cars and vans up to 5 l (petrol) and 2 l (diesel)
- Power bank function, fast charging USB – charge a device on the go
- Integrated "controlled start" boost – jump start batteries from 0V

Benefits

- Reverse polarity, short circuit and anti-spike protection
- Includes integrated LED torch with flashing function to attract attention or to illuminate engine bay in low light conditions or at night
- Intelligent clamps safely manage power between the jump starter and vehicle
- 2-year guarantee¹⁾

**BATTERYjumpstart
1500**

Compact and powerful lithium jump starter with "boost"-function for fully discharged batteries to jump start vehicles with up to 6 l (petrol) and 3 l (diesel) from flat.

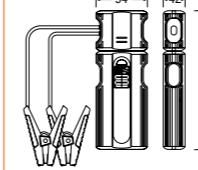

OJS030

Features

- A compact lithium starter – easy to carry, use and store
- 12 000 mAh battery – for small to medium cars and vans up to 6 l (petrol) and 3 l (diesel)
- Power bank function, fast charging USB – charge a device on the go
- Integrated "controlled start" boost – jump start batteries from 0V

Benefits

- Reverse polarity, short circuit and anti-spike protection
- Includes integrated LED torch with flashing function to attract attention or to illuminate engine bay in low light conditions or at night
- Intelligent clamps safely manage power between the jump starter and vehicle
- 2-year guarantee¹⁾

**BATTERYjumpstart
1000TI**

A versatile device perfect for jumpstarting fully discharged batteries and inflating tyres to the correct pressure.

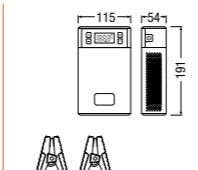

OJS020TI

Features



- Starts petrol vehicles up to 5 l and 3 l diesel with integrated "controlled start" boost – jump start batteries from 0V
- Inflates a tyre from flat in 3.5 minutes²⁾
- Integrated LED light (torch, red flashing and strobe)
- Power bank function





Benefits

- Reverse polarity, short circuit and anti-spike protection
- Rechargeable via USB-C
- Accessories included – USB-A to USB-C cable, inflator accessories and storage case
- 2-year guarantee¹⁾

¹⁾ For precise conditions please refer to www.osram.com/am-guarantee.

¹⁾ For precise conditions please refer to www.osram.com/am-guarantee. ²⁾ Measurements of the tyre pressure and inflation of the tyres to the optimum tyre pressure must always be conducted on cold tyres. Inflation time guide based on inflating a 13" tyre to 2.4 BAR.

BATTERYstart range			
			
Name	BATTERYstart 200	BATTERYstart 300	BATTERYstart 400
Product number	OBSL200	OBSL300	OBSL400
EAN	4052899620476	4052899620483	4052899620490
Petrol engine size (l)	3	6	8
Diesel engine size (l)	N/A	3	4
Battery Capacity (mAh)	6000	13000	16800
Starting Current (A)	150	300	400
Peak Current (A)	500	1500	2000
Boost function	No	No	No
Inflation time	N/A	N/A	N/A
Light	LED light	LED light	LED light
Charging time (h)	2	3	4
Power Bank Function	Yes	Yes	Yes
USB sockets	1	2	2
Storage case	Yes	Yes	Yes

BATTERYjumpstart range				
				
Name	BATTERYjumpstart 500	BATTERYjumpstart 1000	BATTERYjumpstart 1500	BATTERYjumpstart 1000TI
Product number	OJS010	OJS020	OJS030	OJS020TI
EAN	4062172408196	4062172408219	4062172408233	4062172408257
Petrol engine size (l)	3	5	6	5
Diesel engine size (l)	1.5	2	3	3
Battery Capacity (mAh)	6000	8000	12000	12000
Starting Current (A)	200	250	350	300
Peak Current (A)	500	1000	1500	1000
Boost function	Yes	Yes	Yes	Yes
Inflation time	N/A	N/A	N/A	3.5 mins ¹⁾
Light	LED light	LED light	LED light	LED light
Charging time (h)	3	2	1	4
Power Bank Function	Yes	Yes	Yes	Yes
USB sockets	1	1	1	1
Storage Case	Yes	Yes	Yes	Yes

1) Measurements of the tyre pressure and inflation of the tyres to the optimum tyre pressure must always be conducted on cold tyres. Inflation time guide based on inflating a 13" tyre to 2.4 BAR.

BATTERYstart STARTERcable 150A

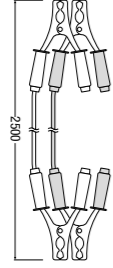

OSC060

A range of starter cables for a quick and easy solution to rapidly transfer the battery power between a donor and a receiver vehicle.

Features

- Suitable for starting vehicles with a petrol engine with capacity ≤ 1.6 l
- Peak Amps 150 A
- Continuous amp rating 75 A
- Length 2.5 m
- Cross section area 6 mm²

Benefits

- Suitable for voltages of 6 V and 12 V
- Copper Coated Aluminum
- Colour coded, insulated cable, handles and clamps
- 2-year guarantee¹⁾

BATTERYstart STARTERcable 200A

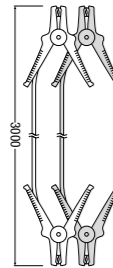

OSC101

A range of starter cables for a quick and easy solution to rapidly transfer the battery power between a donor and a receiver vehicle.

Features

- Suitable for starting vehicles with a petrol engine with capacity ≤ 2.0 l
- Peak Amps 200 A
- Continuous amp rating 100 A
- Length 3 m
- Cross section area 8.5 mm²

Benefits

- Suitable for voltages of 6 V and 12 V
- Copper Coated Aluminum
- Colour coded, insulated cable, handles and clamps
- 2-year guarantee¹⁾

BATTERYstart STARTERcable 300A

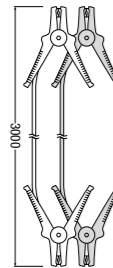

OSC160

A range of starter cables for a quick and easy solution to rapidly transfer the battery power between a donor and a receiver vehicle.

Features

- Suitable for starting vehicles with a petrol and diesel engines with capacity ≤ 3.5 l
- Peak Amps 300 A
- Continuous amp rating 150 A
- Length 3 m
- Cross section area 16 mm²

Benefits

- Suitable for voltages of 6 V and 12 V
- Copper Coated Aluminum
- Colour coded, insulated cable, handles and clamps
- 2-year guarantee¹⁾

BATTERYstart STARTERcable 700A

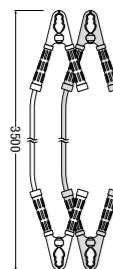

OSC250A

A range of starter cables for a quick and easy solution to rapidly transfer the battery power between a donor and a receiver vehicle.

Features

- Suitable for starting vehicles with a petrol and diesel engines with capacity ≤ 5.5 l
- Peak Amps 700 A
- Continuous amp rating 350 A
- Length 3.5 m
- Cross section area 25 mm²

Benefits

- Suitable for voltages of 12 V and 24 V
- Copper Coated Aluminum
- Colour coded, insulated cable, handles and clamps
- 2-year guarantee¹⁾

BATTERYstart STARTERcable 900A

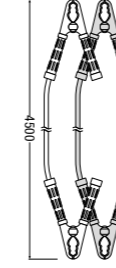

OSC350A

A range of starter cables for a quick and easy solution to rapidly transfer the battery power between a donor and a receiver vehicle.

Features

- Suitable for starting vehicles with a petrol and diesel engines with capacity ≤ 7.0 l
- Peak Amps 900 A
- Continuous amp rating 450 A
- Length 4.5 m
- Cross section area 35 mm²

Benefits

- Suitable for voltages of 12 V and 24 V
- Copper Coated Aluminum
- Colour coded, insulated cable, handles and clamps
- 2-year guarantee¹⁾

BATTERYstart STARTERcable 1200A

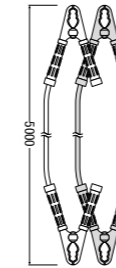

OSC500A

A range of starter cables for a quick and easy solution to rapidly transfer the battery power between a donor and a receiver vehicle.

Features

- Suitable for starting vehicles with a petrol and diesel engines with capacity ≤ 9.5 l
- Peak Amps 1200 A
- Continuous amp rating 600 A
- Length 5 m
- Cross section area 50 mm²

Benefits

- Suitable for voltages of 12 V and 24 V
- Copper Coated Aluminum
- Colour coded, insulated cable, handles and clamps
- 2-year guarantee¹⁾

¹⁾ For precise conditions please refer to www.osram.com/am-guarantee.

¹⁾ For precise conditions please refer to www.osram.com/am-guarantee.

BATTERYcharge Cable

range



Name	BATTERYstart STARTERCable 150A	BATTERYstart STARTERCable 200A	BATTERYstart STARTERCable 300A	BATTERYstart STARTERCable 700A	BATTERYstart STARTERCable 900A	BATTERYstart STARTERCable 1200A
Product number	OSC060	OSC101	OSC160	OSC250A	OSC350A	OSC500A
EAN	4062172220835	4062172220859	4062172220873	4062172220910	4062172220958	4062172220996
Peak amps (A)	150	200	300	700	900	1200
Continuous amp Rating (A)	75	100	150	350	450	600
Voltage (V)	6/12	6/12	6/12	12/24	12/24	12/24
Length (m)	2.5	3	3	3.5	4.5	5
Cross sectional area	6 mm ²	8.5 mm ²	16 mm ²	25 mm ²	35 mm ²	50 mm ²
Engine Size (l)	≤1.6	≤2.0	≤3.5	≤5.5	≤7.0	≤9.5
Engine Type	Petrol	Petrol	Petrol/Diesel	Petrol/Diesel	Petrol/Diesel	Petrol/Diesel
Storage Bag	Yes	Yes	Yes	Yes	Yes	Yes



230 V AC:

OSRAM power inverters provide the standard mains connection for powering tools and equipment.

4 Power inverters

For all your off-grid needs

With a high-quality OSRAM inverter, you are always ideally equipped to power electronics on the move. Our POWERinvert PRO range provides reliable 230 V AC power connection to power drills, laptops and other essential electrical equipment, that otherwise require a mains connection and can be operated directly from the car, van or camper. The range includes pure and modified sine wave inverters for 12 V and 24 V batteries, with power levels ranging from 600 W to 2 000 W.



Safety: All OSRAM power inverters are equipped with a residual-current device to protect against electric shock.



Low battery alarm: Alerts operators when the vehicle battery is running low on charge.



Quality guaranteed: All OSRAM inverters have a minimum guarantee period of 2-years.¹⁾

¹⁾ For precise conditions please refer to www.osram.com/am-guarantee.

POWERinvert Modified sine wave inverter 12 V DC 150 W

A compact 150 W modified sine wave inverter with adjustable voltage output, for powering simple electronic devices and tools.

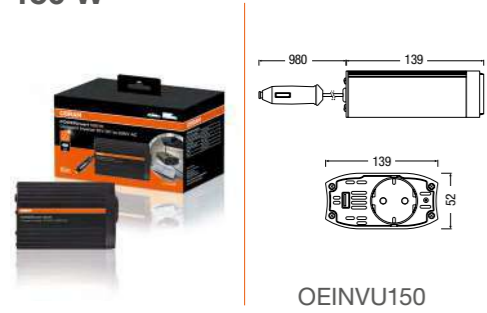

OEINVU150

Features

- 150 W modified sine wave inverter for 12 V vehicles
- Converts into 230 V AC mains power
- Surge power rating (up to 200 ms) 300 W
- Efficiency at 75% load: 89%

Benefits

- Adjustable output: 230 V AC +/- 10%
- Overload, overheating, and low/high voltage protection
- Up to 12 hours continuous use
- 2-year guarantee¹⁾

POWERinvert Modified sine wave inverter 12 V DC 300 W

A compact 300 W modified sine wave inverter with adjustable voltage output, for powering simple electronic devices and tools.

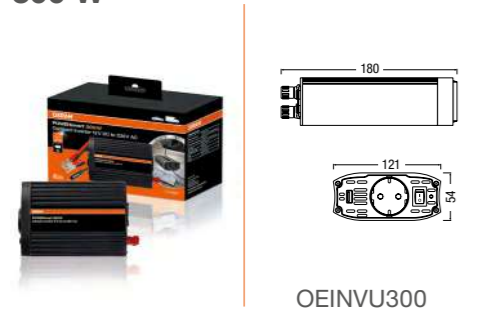

OEINVU300

Features

- 300 W modified sine wave inverter for 12 V vehicles
- Converts into 230 V AC mains power
- Surge power rating (up to 200 ms) 600 W
- Efficiency at 75% load: 89%

Benefits

- Adjustable output: 230 V AC +/- 10%
- Overload, overheating, and low/high voltage protection
- Up to 12 hours continuous use
- 2-year guarantee¹⁾

POWERinvert Modified sine wave inverter 12 V DC 500 W

A compact 500 W modified sine wave inverter with adjustable voltage output, for powering simple electronic devices and tools.



OEINVU500

Features

- 500 W modified sine wave inverter for 12 V vehicles
- Converts into 230 V AC mains power
- Surge power rating (up to 200 ms) 1 000 W
- Efficiency at 75% load: 89%

Benefits

- Adjustable output: 230 V AC +/- 10%
- Overload, overheating, and low/high voltage protection
- Up to 12 hours continuous use
- 2-year guarantee¹⁾

POWERinvert

range



	POWERinvert 150 W	POWERinvert 300 W	POWERinvert 500 W
Name	POWERinvert 150 W	POWERinvert 300 W	POWERinvert 500 W
Product number	OEINVU150	OEINVU300	OEINVU500
EAN	4062172406574	4062172406598	4062172406611
Voltage (V)	12	12	12
Cont. power rating (up to 12 hrs) (W)	150	300	500
Peak power rating (up to 200 ms) (W)	300	600	1000
Output voltage (V)	230 AC ± 10%	230 AC ± 10%	230 AC ± 10%
Output waveform	Modified sine wave	Modified sine wave	Modified sine wave
Input voltage range (V)	10 - 15 V DC	10 - 15 V DC	10 - 15 V DC
Low battery shutdown (V)	<10.5 V DC	<10.5 V DC	<10.5 V DC
Thermal protection (Celsius)	>65 °C	>65 °C	>65 °C
LCD screen	No	No	No
USB port (A)	Yes	Yes	Yes

¹⁾ For precise conditions please refer to www.osram.com/am-guarantee.



360° rotation:

The flashing amber light rotates, improving visibility and enhancing safety.

5 Warning, safety and reading lights

For roadside repairs and emergencies

OSRAM LEDguardian® lights are a valuable tool for roadside repairs in low-visibility conditions. Their compact design and magnetic base allow for easy storage and fast installation, while powerful flashing LEDs alert other road users to your position in an emergency situation.



Compact design:
For quick and easy attachment to the vehicle.



IP- & IK-Protection classes:
Tested and validated in our DIN certified environmental simulation laboratory for extreme external influences regarding water, dust, impacts, heat, cold and permanent vibration.



Guarantee:¹⁾
LEDguardian® warning and safety lights are backed by a 2-year guarantee.

Interior comfort isn't a luxury, it's a necessity

Our ONYX COPILOT® reading lights become one with your vehicle, seamlessly adapting to every space with flexibility and precision.



Multi-Positioning:
Allows you to easily direct light output exactly where you need it.



Comfort:
Pleasantly warm and glare-free light for the interior of the vehicle.

LEDguardian® TRUCK FLARE Signal TA19

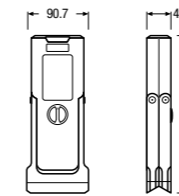

LEDSSL103

A battery powered warning light which must be carried along in the vehicle and used in the event of a break-down in Germany. This applies to all vehicles with a total weight of $\geq 3.5t$ according to §53a StVZO.

Features

- Mandatory¹⁾ in Germany for vehicles $\geq 3.5t$ recommended for other countries & vehicles $\leq 3.5t$ – GGVS/ADR certified, street legal in Germany – TA19 StVZO
- Up to 6 000 K
- LED warning light + LED torch light (2 in 1)
- Protection classes: IP54, IK06

Benefits

- Signals the position of the damaged, broken down etc. vehicle simply by positioning the truck flare next to the warning triangle
- Torch light allowing different product applications
- Non-slip, stable standing feet
- Small, compact, lightweight
- 2-year guarantee²⁾

LEDguardian® ROAD FLARE Signal TA20

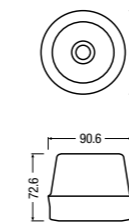

LEDSSL104

A rechargeable amber warning light with 360° flashing and magnetic base.

Features

- Officially approved for road use in Germany in accordance with § 53a section 3 TA20 StVZO¹⁾
- Officially authorized by TÜV & KBA / TA20, CE, UKCA certification
- Up to 2 000 K
- 18 high-quality longlife LEDs
- 360° flashing amber warning light
- Protection class: IP54

Benefits

- Magnetic base for easy installation on roof
- Water, dust, and high wind resistance
- Rechargeable battery, runtime up to 15 h (USB-C cable included)
- Non-slip, dirt-repellent surface
- Small, compact, lightweight
- 2-year guarantee²⁾

LEDguardian® ROAD FLARE Signal V16 IoT

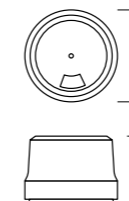

LEDSSL105

A battery-powered, long range amber warning light with 360° flashing and magnetic base. The warning light is connected to the DT 3.0 platform and is mandatory for all vehicles in Spain from January 2026.

Features

- 140 lm light output and up to 1 000 m light range
- Up to 1 900 K
- Road authorisation and mandatory in Spain from January 2026
- 360° flashing amber DGT 3.0 certified warning light
- Integrated SIM card (Connectivity service life of 12 years)
- Protection class: IP54

Benefits

- Anonymous data transfer to the DGT 3.0 platform, signaling the vehicle's position
- Quick and secure mounting on the vehicle due to the compact design and magnetic attachment
- Water, dust and shock resistant
- Battery life up to 2.5 hours (9 V battery included)
- 2-year guarantee²⁾

LEDguardian® ROAD FLARE Signal V16

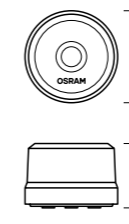

LEDSSL102

A battery-powered, long range amber warning light with 360° flashing, and magnetic base.

Features

- 140 lm light output and up to 1 000 m light range
- Up to 2 000 K
- 12 high-quality long-life LEDs
- 360° flashing amber V16 regulated warning light and CE certified
- Protection class: IP54

Benefits

- Due to the magnetic function the LED warning light can be conveniently attached to the car and other vehicles
- Water, dust, and high wind resistance
- Non-slip, stable standing feet
- Small, compact, lightweight
- 2-year guarantee²⁾

¹⁾ For precise conditions please refer to www.osram.com/am-guarantee.

¹⁾ Please observe any special requirements and laws in countries outside Germany regarding the use and operation of an additional warning light in road traffic.
²⁾ For precise conditions please refer to www.osram.com/am-guarantee.

LEDguardian® ROAD FLARE

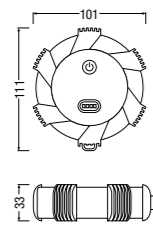

LEDSL303

A battery-powered, long range amber warning light with 360° flashing, and magnetic base.

Features

- 360° rotating bright, amber warning light¹⁾ with three different operating modes: amber warning light function, permanent amber light function and a white torch function
- Battery runtime up to 15 h, Battery status indicator
- Long lifespan and therefore energy efficient
- Protection classes: IP54, IK07

Benefits

- Improved visibility and thus increased safety for you and others in road traffic
- Signals the position of the damaged or broken-down vehicle
- Water, dust, and high wind resistance
- Non-slip, dirt-repellent surface, a practical magnetic hook for attachment
- 2-year guarantee²⁾

LEDguardian® SAVER LIGHT PLUS

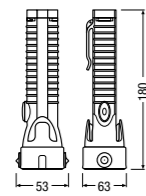

LEDSL101

A practical all-rounder with torch, work light and warning light in one product.

Features

- Be prepared for serious situations, thanks to high quality, long lasting LEDs
- Up to 6 500 K
- Multifunctional magnetic LED warning light¹⁾ with two light functions (amber flashing and white torch light), seat-belt cutter and emergency hammer
- Protection class: IP54

Benefits

- Getting out by smashing the window or cutting the seat-belt
- Flexible mounting possibilities as well as dirt-resistant
- More durability due to LED technology for a long service life
- 2-year guarantee²⁾

LIGHTsignal LED BEACON LIGHT

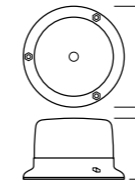

RBL102

A 360° rotating yellow LED beacon light that can be mounted on vehicles with unusual width, length or load, as well as on municipal vehicles, emergency, command and accident relief vehicles.

Features

- 360° rotating beacon light with 8 high-performance long-life LEDs
- Up to 1 200 lm and up to 1 900 K
- Certified in accordance with ECE R10 and R65, mounting method: 3 bolt fix
- Protection classes: IP65, IK08

Benefits

- Improved visibility and thus increased safety for you and others
- Mounting material included in scope of supply
- Insensitive to shocks and the ingress of dust and water
- Compact and modern design
- 2-year guarantee¹⁾

LIGHTsignal HAL BEACON LIGHT

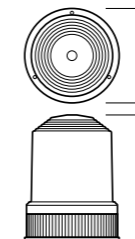

RBL101

A 360° rotating yellow halogen beacon light that can be mounted on vehicles with unusual width, length or load, as well as on municipal vehicles, emergency, command and accident relief vehicles.

Features

- 360° rotating beacon light
- Up to 1 900 lm and up to 2 200 K
- Certified in accordance with ECE R10 and R65, mounting method: 3 bolt fix
- Optimum light output, bundling and distribution due to rotating unit consisting of highly polished parabolic reflector and H1 halogen lamp
- Protection class: IP65

Benefits

- Improved visibility and thus increased safety for you and others
- Mounting material included in scope of supply
- Insensitive to shocks and the ingress of dust and water
- Robust and functional design
- 2-year guarantee¹⁾

LEDguardian® range						
Name	LEDguardian® TRUCK FLARE Signal TA19	LEDguardian® ROAD FLARE Signal TA20	LEDguardian® ROAD FLARE Signal V16 IoT	LEDguardian® ROAD FLARE Signal V16	LEDguardian® ROAD FLARE	LEDguardian® SAVER LIGHT PLUS
Product number	LEDSL103	LEDSL104	LEDSL105	LEDSL102	LEDSL303	LEDSL101
EAN	4062172185967	4062172295840	4062172397599	4062172184359	4062172295642	4052899132344
Voltage (V)	6	3.7	9	9	4.5	3
Watts (W)	3/1.5	2.2	4.5	6	1.85	1.7
Max Lumen output (lm)	100/70	140	140	140	75	105
Colour	Amber/White	Amber	Amber	Amber	Amber/White	Amber/White
Kelvin (K)	2000/6000	2000	1900	2000	2000/6500	6500

LEDsignal range	
Name	LIGHTsignal LED BEACON LIGHT
Product number	RBL102
EAN	4062172232258
Voltage (V)	7
Watts (W)	12/24
Max Lumen output (lm)	1200
Colour	Amber/White
Kelvin (K)	1900

1) Please observe any special requirements and laws in countries outside Germany regarding the use and operation of an additional warning light in road traffic.
2) For precise conditions please refer to www.osram.com/am-guarantee.

1) For precise conditions please refer to www.osram.com/am-guarantee.

ONYX COPILOT® ONYX M+7

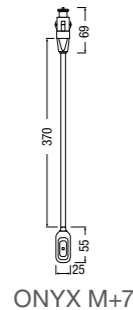

ONYX M+7

A flexible LED reading light that emits a pleasantly warm, glare-free light and is powered via a cigarette lighter.

Features

- Bright LED reading light for vehicle interior, 12 V & 24 V compatible
- Service life (LED): up to 20 000 h
- Powered via cigarette lighter
- Individual adjustment thanks to bendable neck
- Pleasant warm and glare-free LED light

Benefits

- Pleasantly look and feel, easy to grip and dirt-resistant surface
- Provides simple installation
- More durability due to LED technology for a long service life
- Light can be switched on/off and remain connected permanently
- 2-year guarantee¹⁾

ONYX COPILOT® ONYX L+7

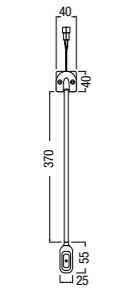

ONYX L+7

A flexible LED reading light that emits a pleasantly warm, glare-free light and comes with a plastic base for fixed connection.

Features

- Bright LED reading light for vehicle interior, 12 V & 24 V compatible
- Service life (LED): up to 20 000 h
- Light with a plastic base for fixed connection
- Individual adjustment thanks to bendable neck
- Pleasant warm and glare-free LED light

Benefits

- Pleasantly look and feel, easy to grip and dirt-resistant surface
- Provides simple installation
- More durability due to LED technology for a long service life
- Light can be switched on/off and remain connected permanently
- 2-year guarantee¹⁾

ONYX COPILOT® ONYX USB

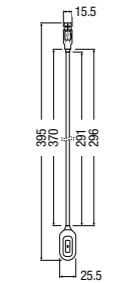

ONYX USB

A flexible LED reading light that emits a pleasantly warm, glare-free light with USB plug in.

Features

- This stylish reading light is suitable for all vehicles with USB connection
- Service life (LED): up to 20 000 h
- Powered via USB
- Individual adjustment thanks to bendable neck
- Pleasant warm and glare-free LED light

Benefits

- Pleasantly look and feel, easy to grip and dirt-resistant surface
- Provides simple installation
- More durability due to LED technology for a long service life
- Light can be switched on/off and remain connected permanently
- 2-year guarantee¹⁾

ONYX COPILOT®

range



ONYX COPILOT®
ONYX M+7



ONYX COPILOT®
ONYX L+7



ONYX COPILOT®
ONYX USB

Name	ONYX M+7	ONYX L+7	ONYX USB
Product number	ONYX M+7	ONYX L+7	ONYX USB
EAN	4062172339377	4052899414938	4052899601000
Voltage (V)	12/24	12/24	12/24
Watts (W)	0.5	0.5	0.5
Max Lumen output (lm)	20	20	20
Kelvin (K)	3200	3200	3000

¹⁾ For precise conditions please refer to www.osram.com/am-guarantee.



LED Driving Lights

High-performance LED lights for on-road use for improved visibility



OSRAM-quality guaranteed

All OSRAM products are extensively stress tested by our quality assurance system. For information concerning guarantees, visit www.osram.com/am-guarantee or scan the QR code.

1

Multifunctional series

With high-beam and LED front positioning functionality, the OSRAM Multifunctional series combines excellent light performance with stylish design elements.



2

Functional series

Get a fully ECE compliant auxiliary high beam and choose between two high beam patterns for improved far and near field illumination.



3

Slim series

Auxiliary high beam spotlights are designed with a slim and compact housing which allows for easy mounting.



4

Value series

These robust and long-lasting lights were developed with a range of lighting profiles, including spot, wide or combo beam patterns for powerful far-field and near-field illumination.



5

Accessories

To support the installation of the OSRAM LEDriving® driving lights, OSRAM has developed a special series with suitable accessories.





Multifunction:
Additional front positioning and daytime running functionality.

1 Multifunctional series

Explore further than ever before, thanks to better light

Why settle for ordinary when you can experience the extraordinary? OSRAM LEDriving® technology combines high performance with the latest innovation in direct illumination. With high-beam and LED front positioning functionality, the OSRAM Multifunctional series combines power with practicality. LEDriving® Multifunctional series offer powerful illumination. Now you can explore further than ever before, safe in the knowledge that OSRAM will light the way.

On-Road:
ECE compliant lighting function for on-road use.

IP- & IK-Protection classes:
Tested and validated in our DIN certified environmental simulation laboratory for extreme external influences regarding water, dust, impacts, heat, cold and permanent vibration.

Guarantee:
5-year OSRAM guarantee.¹⁾

¹⁾ For precise conditions please refer to www.osram.com/am-guarantee.

LEDriving® Lightbar MX250-CB



A lightbar with high-beam and LED front positioning functionality, combining excellent light performance with stylish design elements.

Features

- COMBO BEAM = Designed for both: far-field and near-field illumination
- Up to 320 m long light beam and a power level of up to 2 700 lm
- 26 high-performance OSRAM LEDs
- Protection class: IP69K

Benefits

- LED high beam with additional front positioning and daytime running functionality
- Combines power with practicality
- Robust and resistant – ensuring long life
- ECE-compliant and approved for use on roads
- 5-year guarantee¹⁾

LEDriving® Round MX180-CB



The round driving light illuminates the far and near field and ensures a modern look.

Features

- COMBO BEAM = Designed for both: far-field and near-field illumination
- Up to 300 m long light beam and a power level of up to 3 000 lm
- 12 high-performance OSRAM LEDs
- Protection class: IP69K

Benefits

- LED high beam with additional front positioning and daytime running functionality
- Combines power with practicality
- Robust and resistant – ensuring long life
- ECE-compliant and approved for use on roads
- 5-year guarantee¹⁾

LEDriving® Round MX260-CB



A round driving light that combines high performance with the latest innovation in direct illumination.

Features

- COMBO BEAM = Designed for both: far-field and near-field illumination
- Up to 350 m long light beam and a power level of up to 3 500 lm
- 36 high-performance OSRAM LEDs
- Protection class: IP69K

Benefits

- LED high beam with additional front positioning and daytime running functionality
- Combines power with practicality
- Robust and resistant – ensuring long life
- ECE-compliant and approved for use on roads
- 5-year guarantee¹⁾

LEDriving® Cube MX240-CB



The cube shaped driving light offer powerful illumination in the near and far field.

Features

- COMBO BEAM = Designed for both: far-field and near-field illumination
- Up to 430 m long light beam and a power level of up to 4 000 lm
- 16 high-performance OSRAM LEDs
- Protection class: IP69K

Benefits

- LED high beam with additional front positioning and daytime running functionality
- Combines power with practicality
- Robust and resistant – ensuring long life
- ECE-compliant and approved for use on roads
- 5-year guarantee¹⁾

¹⁾ For precise conditions please refer to www.osram.com/am-guarantee.

OSRAM LEDriving® Multifunctional series (MX)

Name	Product number	EAN	No. Of LED	V	W	Max Lumen output	(m) @1 Lux	K	IP	ECE	ECE Ref. No	Product weight net (g)
Lightbar MX250-CB	LEDDL110-CB	4062172153959	26	12/24	45/1	2700	320	6000	IP69K	R10, R7, R112	30	2000
Round MX180-CB	LEDDL111-CB	4062172153973	12	12/24	39/1	3000	300	6000	IP69K	R10, R7, R112	25	2300
Round MX260-CB	LEDDL112-CB	4062172153997	36	12/24	60/2.5	3500	350	6000	IP69K	R10, R7, R112	50	4440
Cube MX240-CB	LEDDL113-CB	4062172154017	16	12/24	70/1.5	4000	430	6000	IP69K	R10, R7, R112	50	3380



Effective:

Efficient reflector design for an appealing and modern look and reduced glare.

2 Functional series

The adventures are just beginning as the daylight ends

Get a fully ECE compliant auxiliary high beam and choose between two high beam patterns for improved far- and near-field illumination. LEDriving® Functional series offer powerful far and near field illumination. Available in a variety of performances, shapes and beam patterns, plus a choice of illumination profiles like spot and combo, these lights will cut through the darkness, no matter how though the terrain.



On-Road:
ECE compliant lighting function for on-road use.



IP- & IK-Protection classes:
Tested and validated in our DIN certified environmental simulation laboratory for extreme external influences regarding water, dust, impacts, heat, cold and permanent vibration.



Guarantee:
5-year OSRAM guarantee.¹⁾

¹⁾ For precise conditions please refer to www.osram.com/am-guarantee.

LEDiving® Lightbar FX125-SP GEN 2



Fully ECE compliant auxiliary high beam for far field illumination.

Features

- SPOT BEAM = Beam pattern for particularly focused high beam distribution
- Up to 270 m long light beam and a power level of up to 1 300 lm
- Efficient reflector lens design with 5 powerful OSRAM LEDs
- Protection classes: IP6K8 & IP6K9K

Benefits

- Superior illumination, performance, quality, design, durability, functionality
- Special reflector design for an appealing and modern look and reduced glare
- Robust and resistant – ensuring long life
- ECE-compliant and approved for use on roads
- 5-year guarantee¹⁾

LEDiving® Lightbar FX250-SP GEN 2



A medium sized lightbar with spot beam pattern for far field illumination.

Features

- SPOT BEAM = Beam pattern for particularly focused high beam distribution
- Up to 360 m long light beam and a power level of up to 2 120 lm
- Efficient reflector lens design with 10 powerful OSRAM LEDs
- Protection classes: IP6K8 & IP6K9K

Benefits

- Superior illumination, performance, quality, design, durability, functionality
- Special reflector design for an appealing and modern look and reduced glare
- Robust and resistant – ensuring long life
- ECE-compliant and approved for use on roads
- 5-year guarantee¹⁾

LEDiving® Lightbar FX250-CB GEN 2



A medium sized lightbar with combo beam pattern for both far and near field illumination.

Features

- COMBO BEAM = Designed for both: far-field and near-field illumination
- Up to 320 m long light beam and a power level of up to 2 520 lm
- Efficient reflector lens design with 10 powerful OSRAM LEDs
- Protection classes: IP6K8 & IP6K9K

Benefits

- Superior illumination, performance, quality, design, durability, functionality
- Special reflector design for an appealing and modern look and reduced glare
- Robust and resistant – ensuring long life
- ECE-compliant and approved for use on roads
- 5-year guarantee¹⁾

LEDiving® Lightbar FX500-SP SM GEN 2



Single mount certified auxiliary high beam for far field illumination.

Features

- SPOT BEAM = Beam pattern for particularly focused high beam distribution
- Up to 470 m long light beam and a power level of up to 3 930 lm
- Efficient reflector lens design with 15 powerful OSRAM LEDs
- Protection classes: IP6K8 & IP6K9K

Benefits

- Single mount certified²⁾ (2x ECE R149)
- Special reflector design for an appealing and modern look and reduced glare
- Robust and resistant – ensuring long life
- ECE-compliant and approved for use on roads
- 5-year guarantee¹⁾

LEDiving® Lightbar FX500-CB SM GEN 2



Single mount certified driving light for both far and near field illumination.

Features

- COMBO BEAM = Designed for both: far-field and near-field illumination
- Up to 380 m long light beam and a power level of up to 3 750 lm
- Efficient reflector lens design with 15 powerful OSRAM LEDs
- Protection classes: IP6K8 & IP6K9K

Benefits

- Single mount certified²⁾ (2x ECE R149)
- Special reflector design for an appealing and modern look and reduced glare
- Robust and resistant – ensuring long life
- ECE-compliant and approved for use on roads
- 5-year guarantee¹⁾

LEDiving® Lightbar FX750-CB SM GEN 2



Single mount certified driving light for both far and near field illumination.

Features

- COMBO BEAM = Designed for both: far-field and near-field illumination
- Up to 450 m long light beam and a power level of up to 5 990 lm
- Efficient reflector lens design with 25 powerful OSRAM LEDs
- Protection classes: IP6K8 & IP6K9K

Benefits

- Single mount certified²⁾ (2x ECE R149)
- Special reflector design for an appealing and modern look and reduced glare
- Robust and resistant – ensuring long life
- ECE-compliant and approved for use on roads
- 5-year guarantee¹⁾

LEDiving® Lightbar FX1000-CB SM GEN 2



Single mount certified driving light for both far and near field illumination.

Features

- COMBO BEAM = Designed for both: far-field and near-field illumination
- Up to 635 m long light beam and a power level of up to 8 000 lm
- Efficient reflector lens design with 40 powerful OSRAM LEDs
- Protection classes: IP6K8 & IP6K9K

Benefits

- Single mount certified²⁾ (2x ECE R149)
- Special reflector design for an appealing and modern look and reduced glare
- Robust and resistant – ensuring long life
- ECE-compliant and approved for use on roads
- 5-year guarantee¹⁾

LEDiving® Lightbar FX1250-CB SM GEN 2



The largest lightbar within the FX series is designed for illuminating the far-field and near-field and allows a central and individual installation.

Features

- COMBO BEAM = Designed for both: far-field and near-field illumination
- Up to 630 m long light beam and a power level of up to 11 000 lm
- Efficient reflector lens design with 45 powerful OSRAM LEDs
- Protection classes: IP6K8 & IP6K9K

Benefits

- Single mount certified²⁾ (2x ECE R149)
- Special reflector design for an appealing and modern look and reduced glare
- Robust and resistant – ensuring long life
- ECE-compliant and approved for use on roads
- 5-year guarantee¹⁾

¹⁾ For precise conditions please refer to www.osram.com/am-guarantee. ²⁾ Single mount – no pairwise installation necessary, due to two certified light sources.

¹⁾ For precise conditions please refer to www.osram.com/am-guarantee. ²⁾ Single mount – no pairwise installation necessary, due to two certified light sources.

OSRAM LEDriving® Functional series (FX)

Name	Product number	EAN	No. Of LED	V	W	Max Lumen output	(m) @1 Lux	K	IP	ECE	ECE Ref. No	Product weight net (g)
Lightbar FX125-SP GEN 2	LEDDL128-SP	4062172365543	5	12/24	18	1300	270	6000	IP6K8, IP6K9K	R10, R149	20	1076
Lightbar FX250-SP GEN 2	LEDDL129-SP	4062172366120	10	12/24	27	2120	360	6000	IP6K8, IP6K9K	R10, R149	30	1478
Lightbar FX250-CB GEN 2	LEDDL130-CB	4062172366106	10	12/24	37	2520	320	6000	IP6K8, IP6K9K	R10, R149	25	1478
Lightbar FX500-SP SM GEN 2	LEDDL131-SP SM	4062172366182	15	12/24	56	3930	470	6000	IP6K8, IP6K9K	R10, 2xR149	30+30	1878
Lightbar FX500-CB SM GEN 2	LEDDL132-CB SM	4062172366168	15	12/24	56	3750	380	6000	IP6K8, IP6K9K	R10, 2xR149	20+20	1878
Lightbar FX750-CB SM GEN 2	LEDDL133-CB SM	4062172366205	25	12/24	94	5990	450	6000	IP6K8, IP6K9K	R10, 2xR149	30+30	2658
Lightbar FX1000-CB SM GEN 2	LEDDL114-CB SM	4062172154031	40	12/24	140	8000	635	6000	IP6K8, IP6K9K	R10, 2xR112	50+50	3840
Lightbar FX1250-CB SM GEN 2	LEDDL134-CB SM	4062172366229	45	12/24	176	11000	630	6000	IP6K8, IP6K9K	R10, 2xR149	50+50	4255



Thin shape:

Slim design for a compact and sleek appearance.

3 Slim series

Powerful performance and versatile applications

Auxiliary high beam spotlights are designed with a slim and compact housing which allows for easy mounting. OSRAM LEDriving® driving lights are a striking addition to your vehicle but if you intend to use them on public roads, there are specific ECE regulations to follow regarding how and where to fit them, and how many lights you're allowed to fit. Making sure your LEDriving® lights are legal on public roads.



On-Road:
ECE compliant lighting function for on-road use.



IP- & IK-Protection classes:
Tested and validated in our DIN certified environmental simulation laboratory for extreme external influences regarding water, dust, impacts, heat, cold and permanent vibration.



Guarantee:
5-year OSRAM guarantee.¹⁾

¹⁾ For precise conditions please refer to www.osram.com/am-guarantee.

LEDDriving® Lightbar SX180-SP



A small and compact auxiliary high beam spotlight for increased far-field visibility.

Features

- SPOT BEAM = Beam pattern for particularly focused high beam distribution
- Up to 190 m long light beam and a power level of up to 1 300 lm
- 6 high-performance OSRAM LEDs
- Protection class: IP6K9K

Benefits

- Designed with a slim and compact housing which allows easy mounting
- Compact mounting dimensions mean that the LED auxiliary light can be used in a wide range of applications
- Robust and resistant – ensuring long life
- ECE-compliant and approved for use on roads
- 5-year guarantee¹⁾

LEDDriving® Lightbar SX300-SP



A small and compact auxiliary high beam spotlight for increased far-field illumination.

Features

- SPOT BEAM = Beam pattern for particularly focused high beam distribution
- Up to 270 m long light beam and a power level of up to 2 600 lm
- 12 high-performance OSRAM LEDs
- Protection class: IP6K9K

Benefits

- Designed with a slim and compact housing which allows easy mounting
- Compact mounting dimensions mean that the LED auxiliary light can be used in a wide range of applications
- Robust and resistant – ensuring long life
- ECE-compliant and approved for use on roads
- 5-year guarantee¹⁾

LEDDriving® Lightbar SX300-CB



A small and compact auxiliary high beam spotlight for increased far-field and near-field visibility.

Features

- COMBO BEAM = Designed for both: far-field and near-field illumination
- Up to 210 m long light beam and a power level of up to 2 600 lm
- 12 high-performance OSRAM LEDs
- Protection class: IP6K9K

Benefits

- Designed with a slim and compact housing which allows easy mounting
- Compact mounting dimensions mean that the LED auxiliary light can be used in a wide range of applications
- Robust and resistant – ensuring long life
- ECE-compliant and approved for use on roads
- 5-year guarantee¹⁾

LEDDriving® Lightbar SX500-SP



A small and compact auxiliary high beam spotlight for increased far-field illumination.

Features

- SPOT BEAM = Beam pattern for particularly focused high beam distribution
- Up to 370 m long light beam and a power level of up to 3 900 lm
- 18 high-performance OSRAM LEDs
- Protection class: IP6K9K

Benefits

- Designed with a slim and compact housing which allows easy mounting
- Compact mounting dimensions mean that the LED auxiliary light can be used in a wide range of applications
- Robust and resistant – ensuring long life
- ECE-compliant and approved for use on roads
- 5-year guarantee¹⁾

LEDDriving® Lightbar SX500-CB



A small and compact auxiliary high beam spotlight for increased far-field and near-field illumination.

Features

- COMBO BEAM = Designed for both: far-field and near-field illumination
- Up to 300 m long light beam and a power level of up to 3 900 lm
- 18 high-performance OSRAM LEDs
- Protection class: IP6K9K

Benefits

- Designed with a slim and compact housing which allows easy mounting
- Compact mounting dimensions mean that the LED auxiliary light can be used in a wide range of applications
- Robust and resistant – ensuring long life
- ECE-compliant and approved for use on roads
- 5-year guarantee¹⁾

OSRAM LEDDriving® Slim series (SX)

Name	Product number	EAN	No. Of LED	V	W	Max Lumen output	(m) @1 Lux	K	IP	ECE	ECE Ref. No	Product weight net (g)
Lightbar SX180-SP	LEDDL105-SP	4052899595415	6	12/24	14	1300	190	6000	IP69K	R10, R112	10	440
Lightbar SX300-SP	LEDDL106-SP	4052899595439	12	12/24	29	2600	270	6000	IP69K	R10, R112	20	700
Lightbar SX300-CB	LEDDL106-CB	4062172142083	12	12/24	29	2600	210	6000	IP69K	R10, R112	12.5	700
Lightbar SX500-SP	LEDDL107-SP	4052899595453	18	12/24	46	3900	370	6000	IP69K	R10, R112	30	1200
Lightbar SX500-CB	LEDDL107-CB	4062172142106	18	12/24	44	3900	290	6000	IP69K	R10, R112	20	1200

¹⁾ For precise conditions please refer to www.osram.com/am-guarantee.

¹⁾ For precise conditions please refer to www.osram.com/am-guarantee.

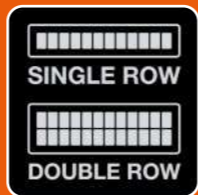

Sleek or robust design:

Available as single-row lightbar for a compact and sleek appearance and double-row lightbar for a more robust design.

4 Value series

Defy the darkness your way

The Value series is designed to offer proven quality and increased vision for forward and rear applications at an economical price. The OSRAM LEDriving® Value series lights intensely illuminate the road and surroundings with ease. These robust and long-lasting lights were developed with a range of lighting profiles, including spot, wide or combo beam patterns for powerful far-field and near-field illumination at the front, rear or side of your truck.



On-Road:
ECE compliant lighting function for on-road use.



IP- & IK-Protection classes:
Tested and validated in our DIN certified environmental simulation laboratory for extreme external influences regarding water, dust, impacts, heat, cold and permanent vibration.



Guarantee:
2-year OSRAM guarantee.¹⁾

¹⁾ For precise conditions please refer to www.osram.com/am-guarantee.

LEDriving® Round VX80-WD



A round driving light designed for near-field illumination.

Features

- WIDE BEAM = Designed for a near field illumination
- Up to 240 m long light beam and a power level of up to 1 150 lm
- 4 high-performance OSRAM LEDs
- Robust and vibration resistant - shatterproof polycarbonate lens
- Protection class: IP67

Benefits

- Combines affordability with excellent illumination, performance, quality, shape, durability and functionality
- Improved view and visibility in low light conditions
- Proven quality and increased vision at an economical price
- ECE-compliant and approved for use on roads
- 2-year guarantee¹⁾

LEDriving® Lightbar VX180-SP SR



A single-row lightbar for increased far-field illumination.

Features

- SPOT BEAM = Beam pattern for particularly focused high beam distribution
- Up to 320 m long light beam and a power level of up to 1 400 lm
- 6 high-performance OSRAM LEDs
- Robust and vibration resistant - shatterproof polycarbonate lens
- Protection classes: IP6K8 & IP6K9K

Benefits

- Brackets included for various mounting options: hanging, standing and side
- Single-row lightbar for a compact and sleek appearance
- Proven quality and increased vision at an economical price
- ECE-compliant and approved for use on roads
- 2-year guarantee¹⁾

LEDriving® Lightbar VX180-SP DR



A Double-row lightbar for a more robust design and coverage of far-field illumination.

Features

- SPOT BEAM = Beam pattern for particularly focused high beam distribution
- Up to 200 m long light beam and a power level of up to 2 100 lm
- 12 high-performance OSRAM LEDs
- Robust and vibration resistant - shatterproof polycarbonate lens
- Protection classes: IP6K8 & IP6K9K

Benefits

- Brackets included for various mounting options: hanging, standing and side
- Double-row lightbar for a more robust design
- Proven quality and increased vision at an economical price
- ECE-compliant and approved for use on roads
- 2-year guarantee¹⁾

LEDriving® Lightbar VX250-SP SR



A medium-sized lightbar in single-row design.

Features

- SPOT BEAM = Beam pattern for particularly focused high beam distribution
- Up to 318 m long light beam and a power level of up to 1 500 lm
- 9 high-performance OSRAM LEDs
- Robust and vibration resistant - shatterproof polycarbonate lens
- Protection classes: IP6K8 & IP6K9K

Benefits

- Brackets included for various mounting options: hanging, standing and side
- Single-row lightbar for a compact and sleek appearance
- Proven quality and increased vision at an economical price
- ECE-compliant and approved for use on roads
- 2-year guarantee¹⁾

¹⁾ For precise conditions please refer to www.osram.com/am-guarantee.

LEDDriving® Lightbar VX250-CB DR



This double-row lightbar features a combo beam pattern for far-field and near-field illumination.

Features

- COMBO BEAM = Designed for both: far-field and near-field illumination
- Up to 170 m long light beam and a power level of up to 2 100 lm
- 24 high-performance OSRAM LEDs
- Robust and vibration resistant
 - shatterproof polycarbonate lens
- Protection classes: IP6K8 & IP6K9K

Benefits

- Brackets included for various mounting options: hanging, standing and side
- Double-row lightbar for a more robust design
- Proven quality and increased vision at an economical price
- ECE-compliant and approved for use on roads
- 2-year guarantee¹⁾

LEDDriving® Lightbar VX500-SP SR



A single-row lightbar with spot beam pattern for increased far-field visibility.

Features

- SPOT BEAM = Beam pattern for particularly focused high beam distribution
- Up to 415 m long light beam and a power level of up to 2 800 lm
- 18 high-performance OSRAM LEDs
- Robust and vibration resistant
 - shatterproof polycarbonate lens
- Protection classes: IP6K8 & IP6K9K

Benefits

- Brackets included for various mounting options: hanging, standing and side
- Single-row lightbar for a compact and sleek appearance
- Proven quality and increased vision at an economical price
- ECE-compliant and approved for use on roads
- 2-year guarantee¹⁾

LEDDriving® Lightbar VX500-CB DR



A double-row lightbar for a more robust design and coverage of far-field and near-field illumination.

Features

- COMBO BEAM = Designed for both: far-field and near-field illumination
- Up to 238 m long light beam and a power level of up to 4 100 lm
- 48 high-performance OSRAM LEDs
- Robust and vibration resistant
 - shatterproof polycarbonate lens
- Protection classes: IP6K8 & IP6K9K

Benefits

- Brackets included for various mounting options: hanging, standing and side
- Double-row lightbar for a more robust design
- Proven quality and increased vision at an economical price
- ECE-compliant and approved for use on roads
- 2-year guarantee¹⁾

LEDDriving® Lightbar VX750-CB SR SM



A single-row lightbar with a compact and sleek appearance and combo beam pattern.

Features

- COMBO BEAM = Designed for both: far-field and near-field illumination
- Up to 410 m long light beam and a power level of up to 4 600 lm
- 27 high-performance OSRAM LEDs
- Single Mount certified
- Robust and vibration resistant
 - shatterproof polycarbonate lens
- Protection classes: IP6K8 & IP6K9K

Benefits

- Brackets included for various mounting options: hanging, standing and side
- Single-row lightbar for a compact and sleek appearance
- Proven quality and increased vision at an economical price
- ECE-compliant and approved for use on roads
- 2-year guarantee¹⁾

LEDDriving® Lightbar VX750-CB DR SM



A single-mount certified lightbar for increased far-field and near-field visibility.

Features

- COMBO BEAM = Designed for both: far-field and near-field illumination
- Up to 340 m long light beam and a power level of up to 8 000 lm
- 72 high-performance OSRAM LEDs
- Robust and vibration resistant
 - shatterproof polycarbonate lens
- Protection classes: IP6K8 & IP6K9K

Benefits

- Brackets included for various mounting options: hanging, standing and side
- Double-row lightbar for a more robust design
- Single mount certified²⁾ (2x ECE R149)
- ECE-compliant and approved for use on roads
- 2-year guarantee¹⁾

LEDDriving® Lightbar VX1000-CB SR SM



A single-row lightbar with a compact and sleek appearance and combo beam pattern.

Features

- COMBO BEAM = Designed for both: far-field and near-field illumination
- Up to 525 m long light beam and a power level of up to 6 000 lm
- 36 high-performance OSRAM LEDs
- Robust and vibration resistant
 - shatterproof polycarbonate lens
- Protection classes: IP6K8 & IP6K9K

Benefits

- Brackets included for various mounting options: hanging, standing and side
- Single-row lightbar for a compact and sleek appearance
- Single mount certified²⁾ (2x ECE R149)
- ECE-compliant and approved for use on roads
- 2-year guarantee¹⁾

LEDDriving® Lightbar VX1000-CB DR SM



A single-mount certified lightbar for increased far-field and near-field visibility.

Features

- COMBO BEAM = Designed for both: far-field and near-field illumination
- Up to 385 m long light beam and a power level of up to 10 100 lm
- 84 high-performance OSRAM LEDs
- Robust and vibration resistant
 - shatterproof polycarbonate lens
- Protection classes: IP6K8 & IP6K9K

Benefits

- Brackets included for various mounting options: hanging, standing and side
- Double-row lightbar for a more robust design
- Single mount certified²⁾ (2x ECE R149)
- ECE-compliant and approved for use on roads
- 2-year guarantee¹⁾

LEDDriving® Lightbar VX1250-CB SR SM



A single-row lightbar with a compact and sleek appearance and combo beam pattern.

Features

- COMBO BEAM = Designed for both: far-field and near-field illumination
- Up to 590 m long light beam and a power level of up to 8 000 lm
- 45 high-performance OSRAM LEDs
- Robust and vibration resistant
 - shatterproof polycarbonate lens
- Protection classes: IP6K8 & IP6K9K

Benefits

- Brackets included for various mounting options: hanging, standing and side
- Single-row lightbar for a compact and sleek appearance
- Single mount certified²⁾ (2x ECE R149)
- ECE-compliant and approved for use on roads
- 2-year guarantee¹⁾

¹⁾ For precise conditions please refer to www.osram.com/am-guarantee.

¹⁾ For precise conditions please refer to www.osram.com/am-guarantee. ²⁾ Single mount – no pairwise installation necessary, due to two certified light sources.

LEDDriving® Lightbar VX1250-CB DR SM



The largest lightbar within the VX series is designed for illuminating the far-field and near-field and allows a central and individual installation.

Features

- COMBO BEAM = Designed for both: far-field and near-field illumination
- Up to 410 m long light beam and a power level of up to 13 700 lm
- 108 high-performance OSRAM LEDs
- Single Mount certified
- Robust and vibration resistant
 - shatterproof polycarbonate lens
- Protection classes: IP6K8 & IP6K9K

Benefits

- Brackets included for various mounting options: hanging, standing and side
- Double-row lightbar for a more robust design
- Single mount certified²⁾ (2x ECE R149)
- ECE-compliant and approved for use on roads
- 2-year guarantee¹⁾

OSRAM LEDDriving® Value series (VX)

Name	Product number	EAN	No. Of LED	V	W	Max Lumen output	(m) @1 Lux	K	IP	ECE	ECE Ref. No	Product weight net (g)
Round VX80-WD	LEDDL119-WD	4062172150712	4	12/24	22	1150	240	6000	IP67	R10, R112	12,5	510
Lightbar VX180-SP SR	LEDDL122-SP SR	4062172365260	6	12/24	19	1400	320	6000	IP6K8, IP6K9K	R10, R149	25	550
Lightbar VX180-SP DR	LEDDL123-SP DR	4062172365284	12	12/24	24	2100	200	6000	IP6K8, IP6K9K	R10, R149	10	621
Lightbar VX250-SP SR	LEDDL115-SP SR	4062172141888	9	12/24	27	1500	318	6000	IP6K8, IP6K9K	R10, R112	30	640
Lightbar VX250-CB DR	LEDDL117-CB DR	4062172141932	24	12/24	30	2100	170	6000	IP6K8, IP6K9K	R10, R112	12,5	1040
Lightbar VX500-SP SR	LEDDL116-SP SR	4062172141918	18	12/24	63	2800	415	6000	IP6K8, IP6K9K	R10, R112	50	1210
Lightbar VX500-CB DR	LEDDL118-CB DR	4062172141956	48	12/24	55	4100	238	6000	IP6K8, IP6K9K	R10, R112	17,5	1920
Lightbar VX750-CB SR SM	LEDDL124-CB SR SM	4062172365307	27	12/24	85	4600	410	6000	IP6K8, IP6K9K	R10, 2xR149	25+25	1995
Lightbar VX750-CB DR SM	LEDDL125-CB DR SM	4062172365345	72	12/24	86	8000	340	6000	IP6K8, IP6K9K	R10, 2xR149	12,5+12,5	2625
Lightbar VX 1000-CB SR SM	LEDDL120-CB SR SM	4062172232159	36	12/24	108	6000	525	6000	IP6K8, IP6K9K	R10, 2xR112	37,5+37,5	2580
Lightbar VX1000-CB DR SM	LEDDL121-CB DR SM	4062172365383	84	12/24	108	10100	385	6000	IP6K8, IP6K9K	R10, 2xR149	17,5+17,5	3300
Lightbar VX1250-CB SR SM	LEDDL126-CB SR SM	4062172365444	45	12/24	153	8000	590	6000	IP6K8, IP6K9K	R10, 2xR149	40+40	3200
Lightbar VX1250-CB DR SM	LEDDL127-CB DR SM	4062172365468	108	12/24	138	13700	410	6000	IP6K8, IP6K9K	R10, 2xR149	20+20	4200



ROBUST +
VIBRATION
RESISTANT

Robust and resistant:

High quality materials, especially light and at the same time robust and vibration resistant.

5 Accessories

Accessories designed for LEDDriving® driving lights

To support the installation of the driving lights, OSRAM has specially produced a series of matching accessories for them. You will find detailed instructions for installing the OSRAM LEDDriving® driving lights inside each product package.



Easy installation:
Specially designed for easy, uncomplicated, and flexible assembly.



Compatibility:
Compatible with OSRAM driving lights.



Guarantee:
2-year OSRAM guarantee.¹⁾

¹⁾ For precise conditions please refer to www.osram.com/am-guarantee.

¹⁾ For precise conditions please refer to www.osram.com/am-guarantee.

LEDriving® Wire Harness AX 1LS



The Wire Harness AX 1LS is suitable for the installation of one light source with one lighting function of the driving light.

Features

- Wire harness for easy installation of one light source with one light function
- On/off switch included which can be mounted in the cockpit
- Suitable for 12 V vehicles

Benefits

- Compatible with all OSRAM LEDriving® driving and working lights
- Easy installation
- 2-year guarantee¹⁾

LEDriving® Wire Harness AX 2LS



The Wire Harness AX 2LS is suitable for the installation of two light sources with one lighting function of the driving light.

Features

- Wire harness for easy installation of two light sources with one light function
- On/off switch included which can be mounted in the cockpit
- Suitable for 12 V vehicles

Benefits

- Compatible with all OSRAM LEDriving® driving and working lights
- Easy installation
- 2-year guarantee¹⁾

LEDriving® License Plate Bracket AX



A practical license plate bracket and holder for the OSRAM LEDriving driving lights in one.

Features

- License plate bracket which facilitates the mounting of driving lights on the front of a vehicle
- Robust Aluminum: High quality materials, especially light and at the same time robust and resistant
- Practical license plate bracket and holder in one

Benefits

- Compatible with a wide range of the luminaires within the OSRAM LEDriving® driving lights range²⁾
- Easy installation
- 2-year guarantee¹⁾

LEDriving® Mounting Kit FX GEN 2 Back Brackets



A mounting kit for different mounting options: hanging and standing.

Features

- Mounting brackets compatible with all OSRAM LEDriving® Functional series FX GEN 2 driving lights
- Specially designed for easy, uncomplicated, and flexible assembly
- Robust and vibration-resistant

Benefits

- Enabling different mounting options: hanging and standing
- Easy installation
- 2-year guarantee¹⁾

OSRAM LEDriving® Accessories (AX)

Name	Product number	EAN	V	Product weight net (g)	Cable length (mm)
Wire Harness AX 1LS	LEDDL ACC 101	4062172147682	12	275	2550
Wire Harness AX 2LS	LEDDL ACC 102	4062172147729	12	348	3400
License Plate Bracket AX	LEDDL ACC 103	4062172147705	-	680	-
Mounting Kit FX GEN 2 Back Brackets	LEDDL FX ACC101	4062172372275	-	517	-



1) For precise conditions please refer to www.osram.com/am-guarantee. 2) Special installation regulations apply. Individual special requirements and legislation of the countries must be observed.

Check the regulations before you mount your LEDriving®

OSRAM LEDriving® driving lights are a striking addition to your vehicle, but if you intend to use them on public roads, you must follow specific ECE regulations regarding their fitting and number. Compliance with ECE regulations (R112, R7, and R23) is essential to ensure your vehicle remains lawful. Begin by choosing ECE "Approved Headlights" (all OSRAM LEDriving® driving lights are approved for on-road use) and follow the mounting instructions.

Every ECE approved headlight has a Reference Number, indicating high beam intensity; the higher the number, the brighter the headlight. Lights meeting regulations have an "E-mark" with the Reference Number next to it. Ensure the sum of Reference Numbers for your standard and additional high beams does not exceed 100.



The golden rule: Stay below 100

Under ECE 112 regulations the total value of your Reference Numbers must not exceed 100. This includes existing high beam lights and any additional mounted lights.

01 HRC PL 12.5 02A-OORL (E 9) M410

In this example, the E-mark is recognizable by an encircled E, whilst the Reference Number is 12.5. Here, the product's Reference Number refers to a single high beam light. So the vehicle will have a total of 25 (12,5 plus 12,5) as its existing total Reference Number.

Legal Regulations
Add the Reference Number of your additional LEDriving® driving lights to your calculation and make sure the sum is not exceeding 100.



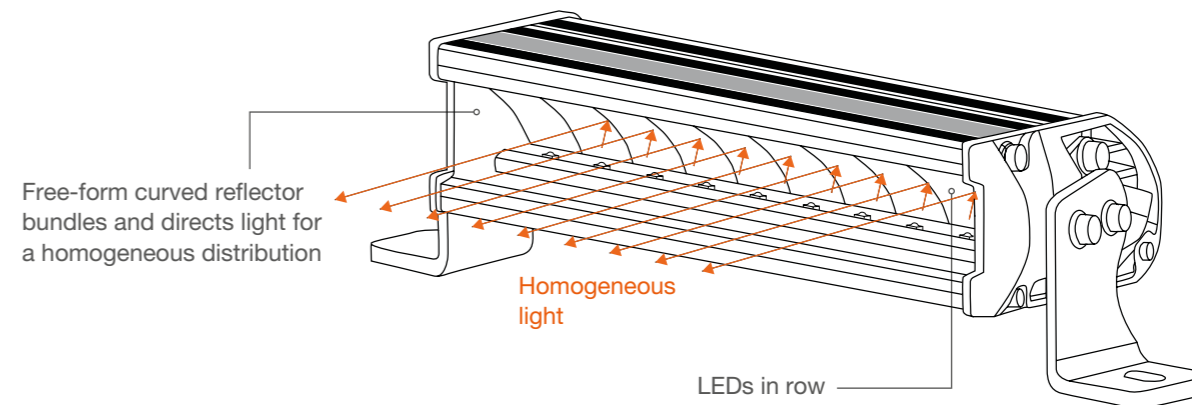

Powered by pure LED performance

We've combined high performance OSRAM LED technology with the latest innovation in indirect illumination. OSRAM's specially designed free-form curved reflector enhances optical performance by redirecting LED light outward to reduce glare and improve visibility.



Tested under extreme conditions

All OSRAM LEDriving® driving lights are rigorously tested under the most extreme environmental conditions to ensure premium quality light for everything nature throws at you.

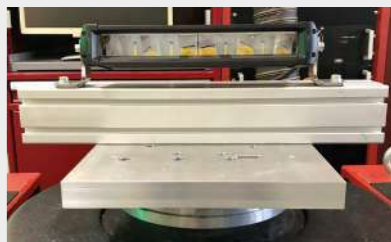
- 1 Water Resistance:**
IP protection class IP67/69K.

- 2 Cold Resistance:**
Tested under extreme temperature.

- 3 Dust Resistance:**
Resistant to the ingress of dust.

- 4 Heat Resistance:**
Tested under extreme temperature.

- 5 Corrosion Resistance:**
Salt spray tested.

- 6 Vibration and Shock Resistance:**
Proven mechanical stability.

Take control when darkness falls Trust in OSRAM

If the road and the surroundings are to be illuminated more intensively, the OSRAM LEDriving® driving lights facing this challenge with ease. Designed with a range of high beam options, including spot and combination patterns with powerful far- and near-field illumination, these robust, long-life lights are available in four different product series: Multifunctional, Functional, Slim and Value. They offer the most sophisticated LED light and electrical design on the market, and are suitable for 12 and 24 voltage vehicles.^{1) 2)}

Advantages of OSRAM Guarantee

OSRAM products are innovative and technologically high-quality products that are carefully-tested and subject to the strict monitoring undertaken by the OSRAM quality assurance system. LEDriving® driving lights are backed by up to 5-year guarantee from OSRAM.¹⁾

Guarantee claim: Step-by-step instructions

Did you experience a defect during the guarantee period? We are sorry because this does not coincide with our quality standards! To resolve the problem, you can of course approach your dealer – or optionally you may contact us. In the latter case, it takes just five simple steps to get a replacement:

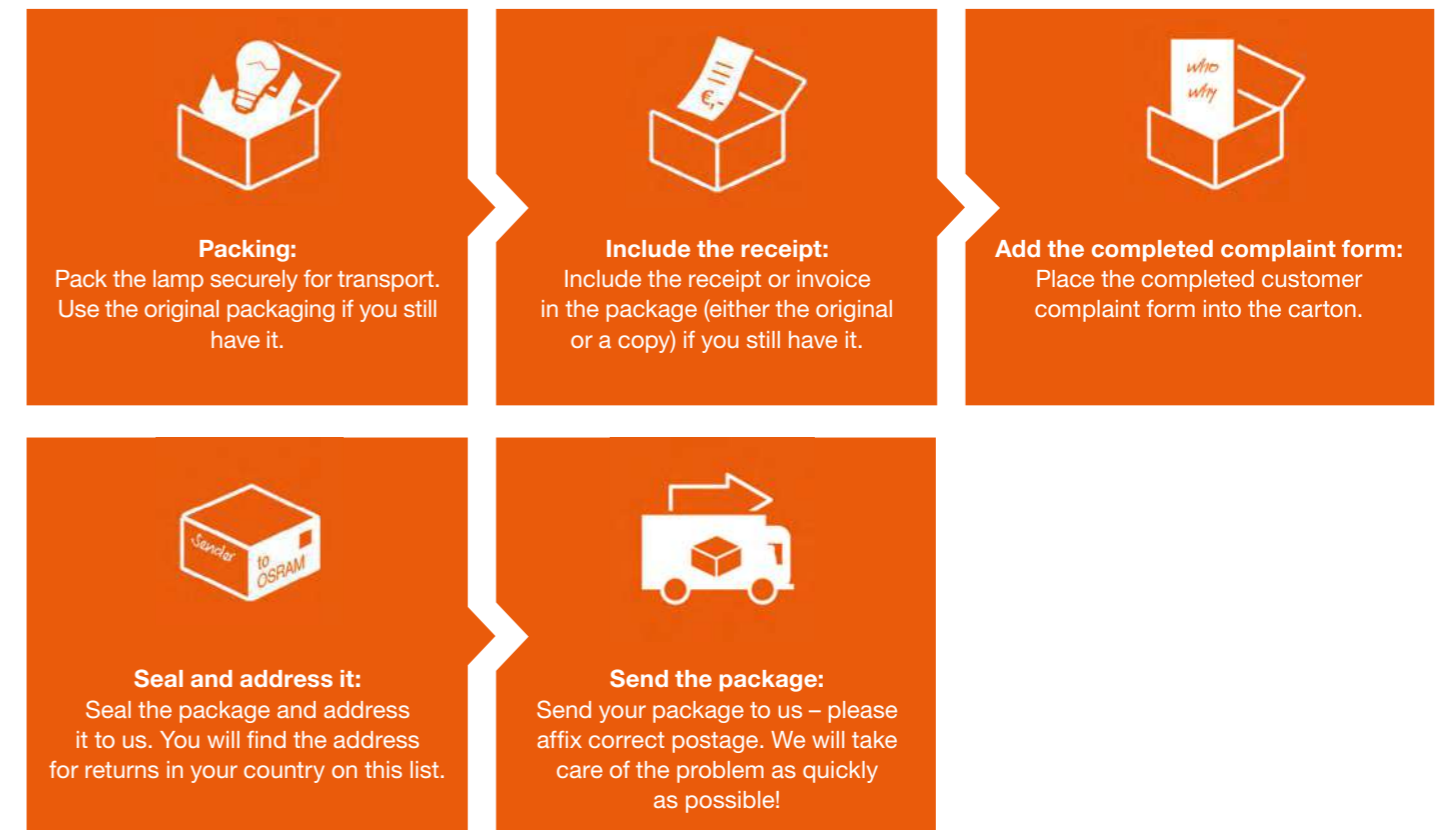

The list of the OSRAM LEDriving® Driving Lights series covered by a 5-year or 2-year guarantee can be found here:
www.osram.com/am-guarantee

1) OSRAM LEDriving® Driving Lights are approved according to ECE regulations and may therefore be installed and operated on public roads. Please note: special installation regulations apply. In addition to ECE approval of the product, individual special requirements and legislation of the countries must be observed. 2) Additional work lights without ECE approval for use as work lights are approved for use on any vehicle according to German Road Traffic Licensing Regulations (StVZO) §52 (7). However, they must not be used switched on while driving. In addition, individual special regulations and laws of countries outside Germany must be observed.

1) 5-year guarantee for FX, MX and SX series. 2-year guarantee for VX and AX series. Refer to www.osram.com/am-guarantee for precise conditions.

Useful information for end-users

OSRAM LEDriving® driving lights have been designed and engineered for a wide range of applications. Each headlight features one of five light beam types to give you maximum visibility exactly where you need it.

Product name – key to its features

Can you decipher the symbol LIGHTBAR VX750 – CB SR SM? If not, read our mini-guide and learn the meanings of the product symbols in our brochure.

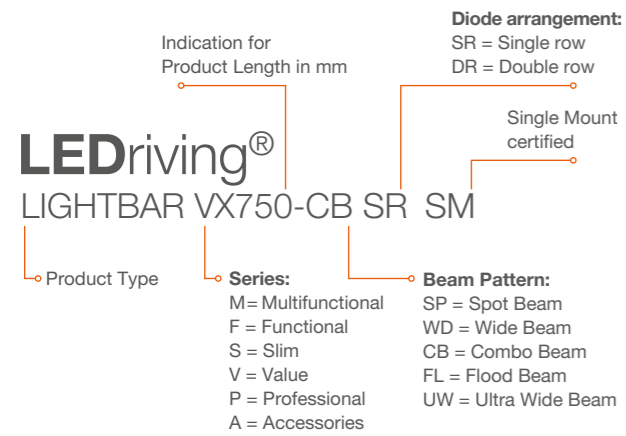

Spot beam:

A spot beam pattern is designed, manufactured and intended for far-field illumination. The reflector design focuses the light beam to a light spot in the far field of the vehicle.

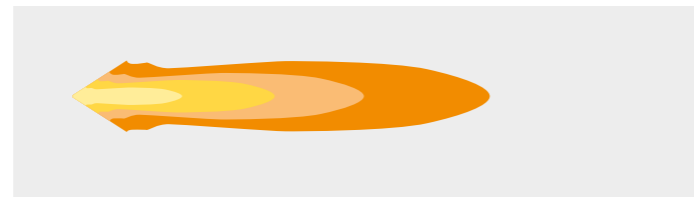

Flood Beam:

A flood beam is designed for near-field illumination. The reflector distributes the light over a large area in the near field of the vehicle.



Wide beam:

A wide beam pattern is designed, manufactured and intended for near-field illumination. The reflector distributes the light widely in the near field around the vehicle.



Ultra Wide Beam:

An Ultra Wide Beam is intended for close-range illumination. With an extra wide light cone, the reflector provides particularly extensive illumination in the vehicle's near field.

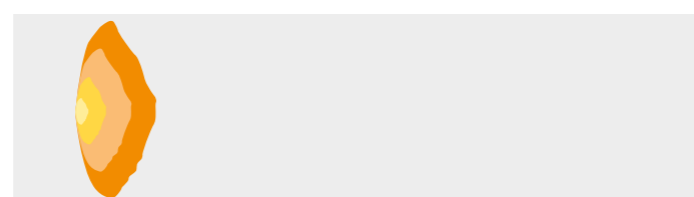

Combo beam:

A combo-beam is designed for both far-field and near-field illumination. The reflector combines a spot and wide beam to achieve wide illumination in the near field and punctual in the far field.

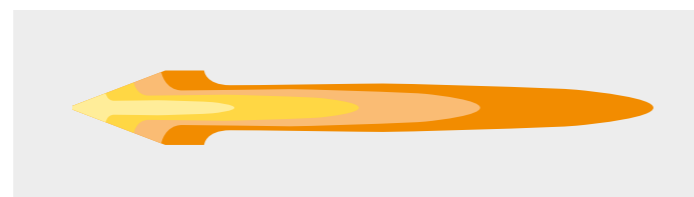

OSRAM LED Driving Lights – Measurements Multifunctional series

LEDriving® Lightbar MX250-CB
LEDDL110-CB

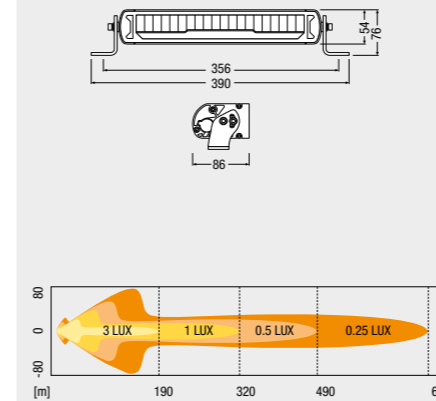

LEDriving® Round MX180-CB
LEDDL111-CB

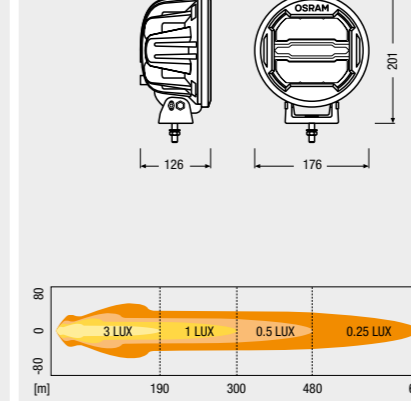

LEDriving® Round MX260-CB
LEDDL112-CB

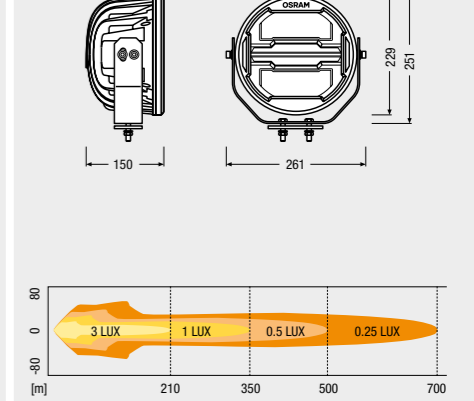

LEDriving® Cube MX240-CB
LEDDL113-CB

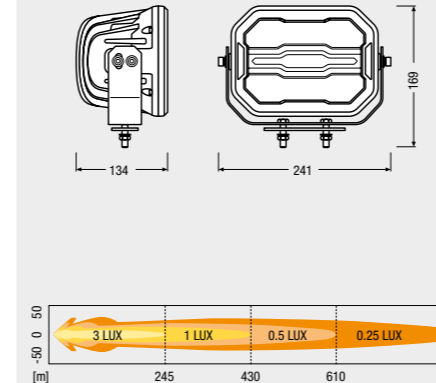

Functional series

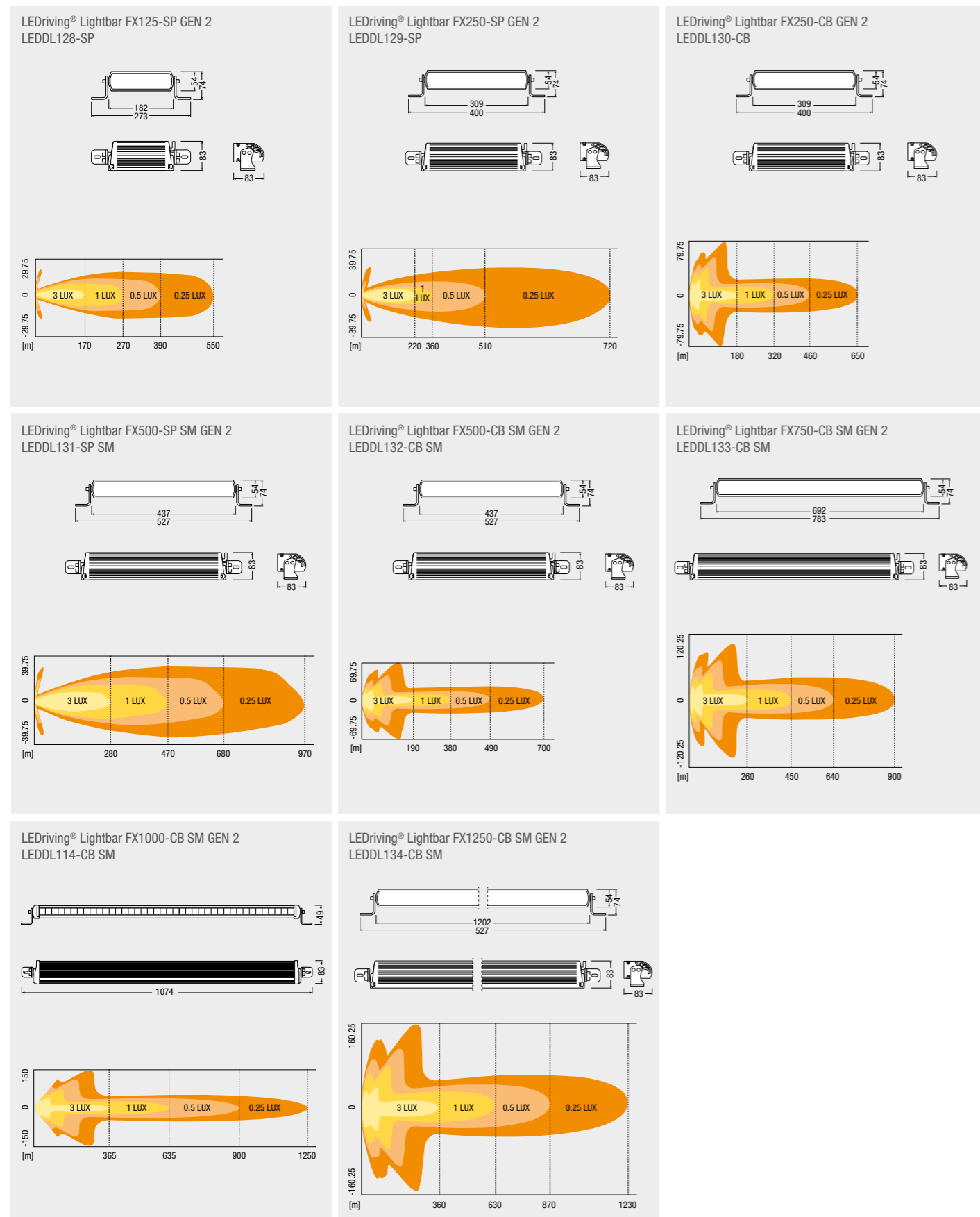

Slim series

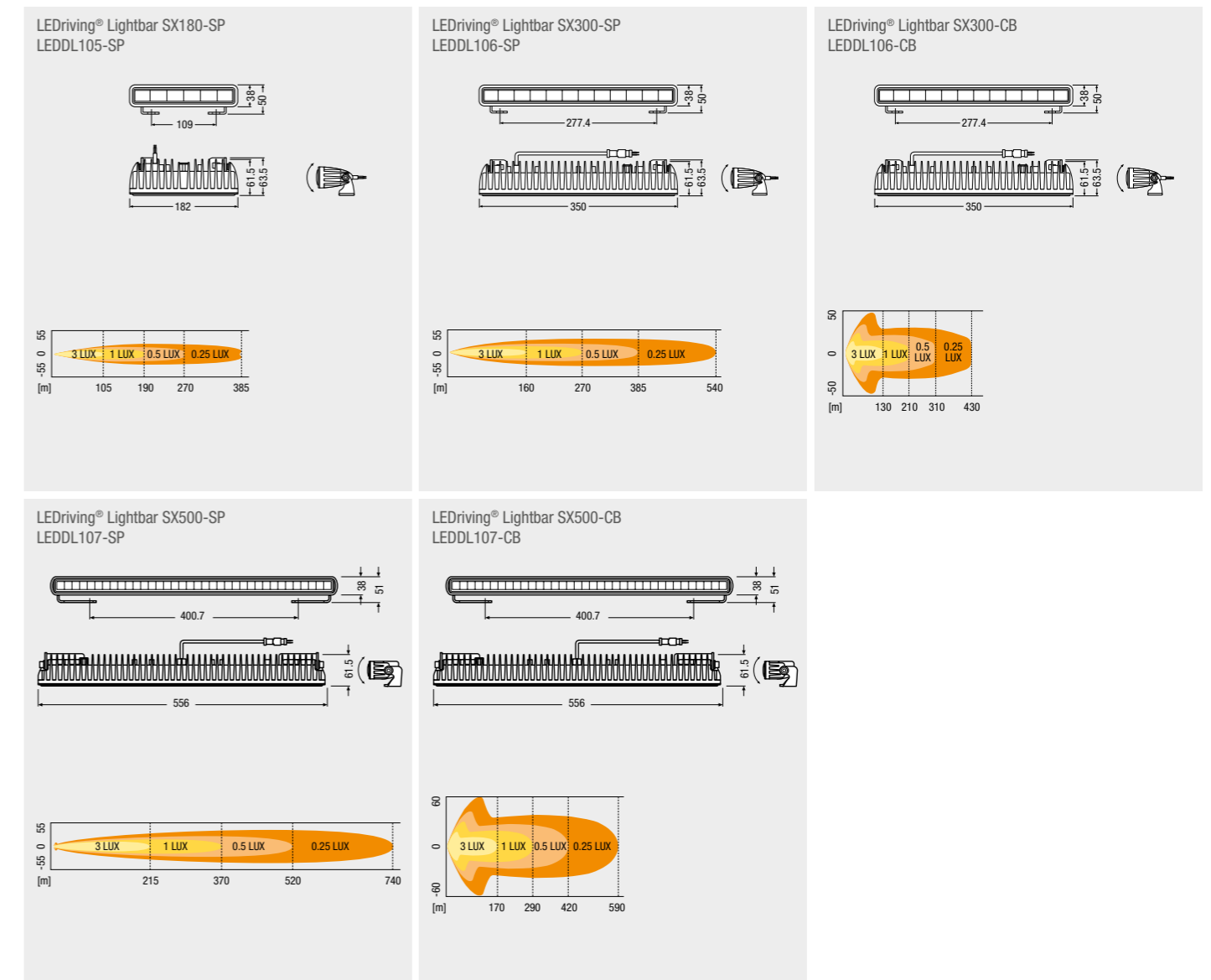

Value series

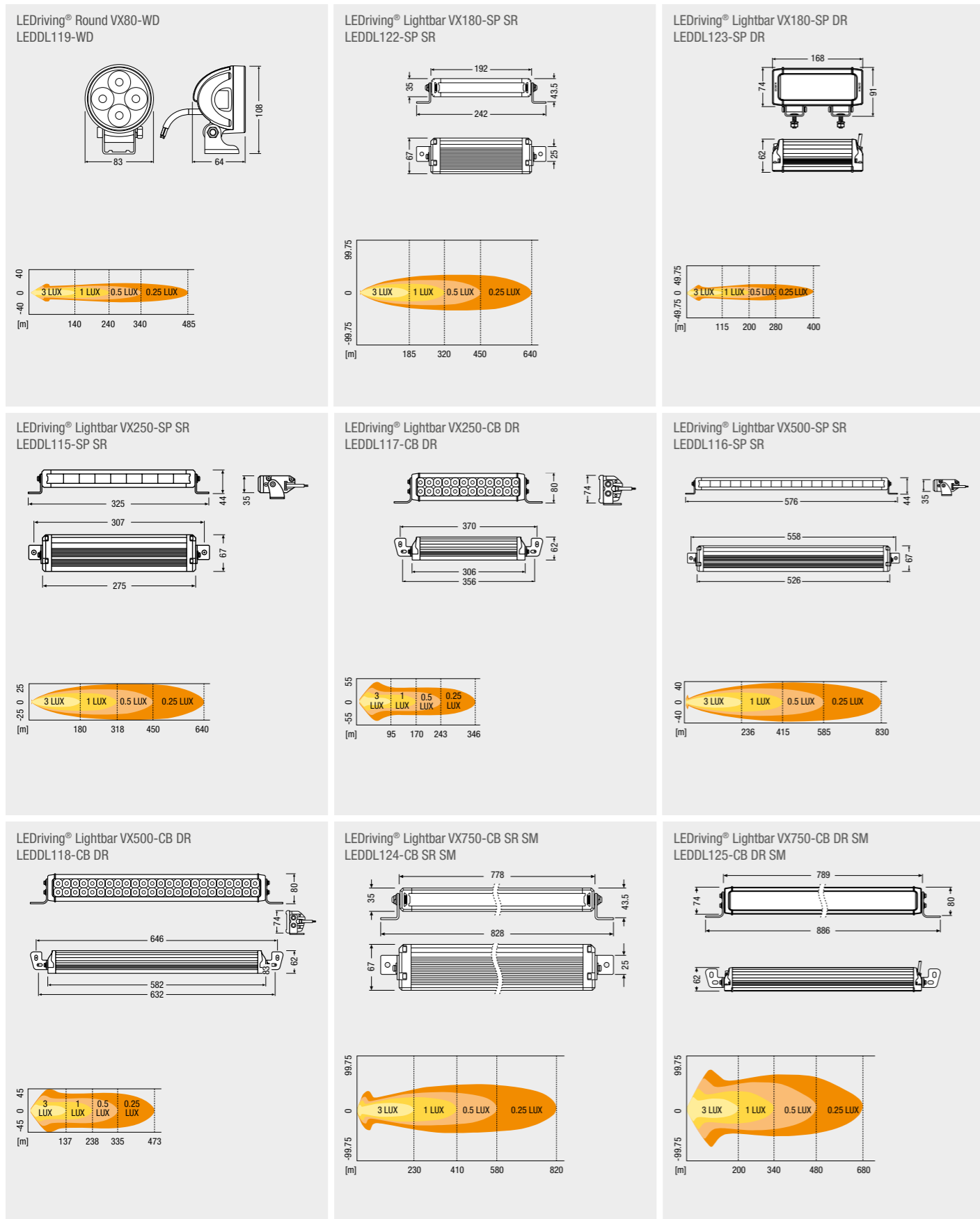

Value series

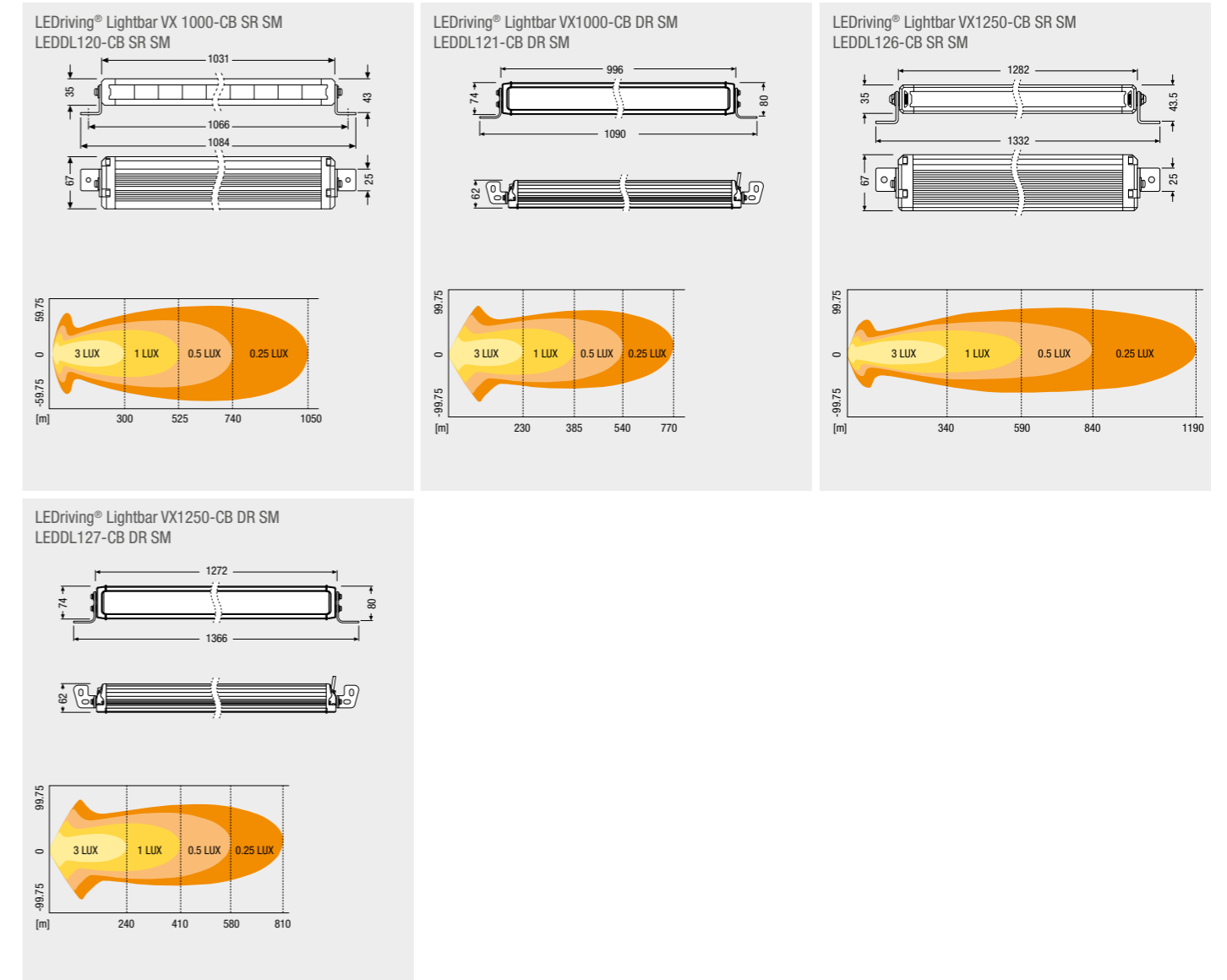

Accessories

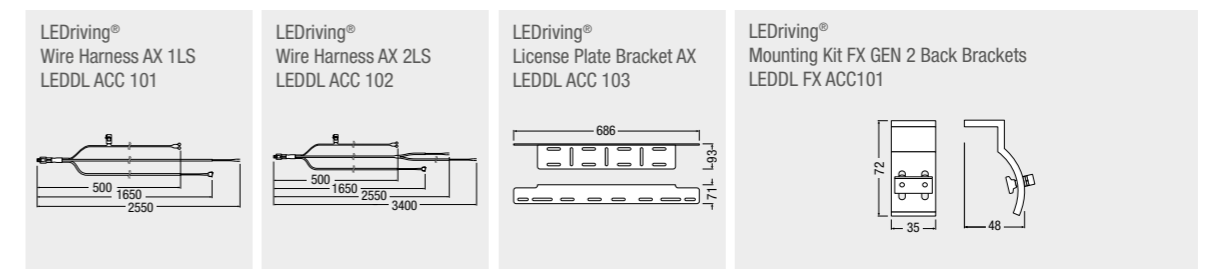



LED Working Lights

Powerful performance
and versatile applications



OSRAM-quality guaranteed

All OSRAM products are extensively stress tested by our quality assurance system. For information concerning guarantees, visit www.osram.com/am-guarantee or scan the QR code.

1

Professional series

The Professional series offers many different combination options for individual lighting needs based on a unique matrix system.



2

Value series

With the Value series, you get remarkable visibility at a reasonable price. Designed to meet the diverse needs of every task, the working lights are available in various shapes, including Cube, Round and Lightbar.



3

Multifunctional series

The Multifunctional series includes a variety of working lights with two light functions: classic working light and the stylish X shape working light.



4

Functional series

The working lights of the Functional series are versatile applicable and flexible in use – On-road as reversing light and for demanding work environments.



5

Accessories

To support the installation of the OSRAM LEDriving working lights, OSRAM has developed a special series with suitable accessories.



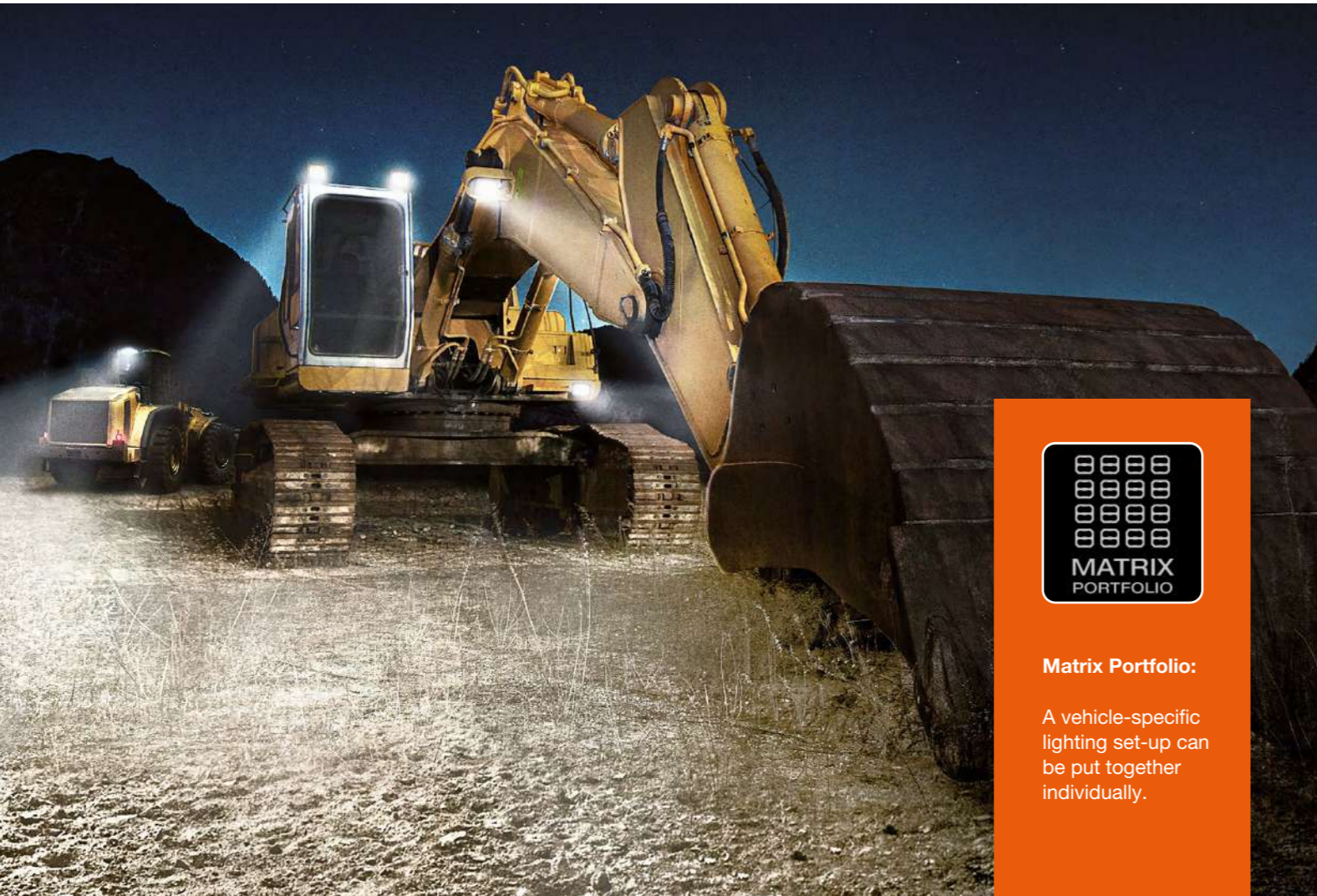

Matrix Portfolio:

A vehicle-specific lighting set-up can be put together individually.

1 Professional series

Professional light for professional work

Work doesn't have to stop when night falls. So you can stick to your deadlines, 24/7. These OSRAM LED lights are robust and compact, combining extremely high optic efficiency with even light distribution and a glare-reducing reflector design. LEDriving® Professional series is available in a variety of performances, shapes and beam patterns, plus a choice of illumination profiles like flood, spot, wide and ultra wide.

1 500 to 4 500 lumens:
Selection of 4 different power levels per beam pattern.

Robust and vibration resistant:
Specially designed for demanding work environments.

IP- & IK-Protection classes:
Tested and validated in our DIN certified environmental simulation laboratory for extreme external influences regarding water, dust, impacts, heat, cold and permanent vibration.

LEDriving® Cube PX1500 Ultra Wide



A 12 V and 24 V suitable working light that features an ultra wide beam pattern and a power level of 1 500 lm.

Features

- ULTRA WIDE BEAM = Beam pattern for particularly large-area and especially wide light distribution
- Up to 40 m long light beam and a power level of 1 500 lm
- Efficient reflector lens design with powerful OSRAM LEDs
- Protection classes: IP6K8 & IP6K9K

Benefits

- Designed to meet the highest OE standards and requirements of the automotive industry
- Various mounting options: Direct mounting, flexible standard mounting, and heavy-duty mounting
- Robust and resistant and specially developed for tough everyday working conditions
- Made in Europe and 5-year guarantee¹⁾

LEDriving® Cube PX2500 Ultra Wide



A 12 V and 24 V suitable working light that features an ultra wide beam pattern and a power level of 2 500 lm.

Features

- ULTRA WIDE BEAM = Beam pattern for particularly large-area and especially wide light distribution
- Up to 55 m long light beam and a power level of 2 500 lm
- Efficient reflector lens design with powerful OSRAM LEDs
- Protection classes: IP6K8 & IP6K9K

Benefits

- Designed to meet the highest OE standards and requirements of the automotive industry
- Various mounting options: Direct mounting, flexible standard mounting, and heavy-duty mounting
- Robust and resistant and specially developed for tough everyday working conditions
- Made in Europe and 5-year guarantee¹⁾

LEDriving® Cube PX3500 Ultra Wide



A 12 V and 24 V suitable working light that features an ultra wide beam pattern and a power level of 3 500 lm.

Features

- ULTRA WIDE BEAM = Beam pattern for particularly large-area and especially wide light distribution
- Up to 65 m long light beam and a power level of 3 500 lm
- Efficient reflector lens design with powerful OSRAM LEDs
- Protection classes: IP6K8 & IP6K9K

Benefits

- Designed to meet the highest OE standards and requirements of the automotive industry
- Various mounting options: Direct mounting, flexible standard mounting, and heavy-duty mounting
- Robust and resistant and specially developed for tough everyday working conditions
- Made in Europe and 5-year guarantee¹⁾

LEDriving® Cube PX4500 Ultra Wide



A 12 V and 24 V suitable working light that features an ultra wide beam pattern and a power level of 4 500 lm.

Features

- ULTRA WIDE BEAM = Beam pattern for particularly large-area and especially wide light distribution
- Up to 70 m long light beam and a power level of 4 500 lm
- Efficient reflector lens design with powerful OSRAM LEDs
- Protection classes: IP6K8 & IP6K9K

Benefits

- Designed to meet the highest OE standards and requirements of the automotive industry
- Various mounting options: Direct mounting, flexible standard mounting, and heavy-duty mounting
- Robust and resistant and specially developed for tough everyday working conditions
- Made in Europe and 5-year guarantee¹⁾

¹⁾ For precise conditions please refer to www.osram.com/am-guarantee.

LEDDriving® Cube PX1500 Wide

A 12 V and 24 V suitable working light that features a wide beam pattern and a power level of 1 500 lm.



Features

- WIDE BEAM = Designed for a near-field illumination
- Up to 35 m long light beam and a power level of 1 500 lm
- Efficient reflector lens design with powerful OSRAM LEDs
- Protection classes: IP6K8 & IP6K9K

Benefits

- Designed to meet the highest OE standards and requirements of the automotive industry
- Various mounting options: Direct mounting, flexible standard mounting, and heavy-duty mounting
- Robust and resistant and specially developed for tough everyday working conditions
- Made in Europe and 5-year guarantee¹⁾

LEDDriving® Cube PX2500 Wide

A 12 V and 24 V suitable working light that features a wide beam pattern and a power level of 2 500 lm.



Features

- WIDE BEAM = Designed for a near-field illumination
- Up to 45 m long light beam and a power level of 2 500 lm
- Efficient reflector lens design with powerful OSRAM LEDs
- Protection classes: IP6K8 & IP6K9K

Benefits

- Designed to meet the highest OE standards and requirements of the automotive industry
- Various mounting options: Direct mounting, flexible standard mounting, and heavy-duty mounting
- Robust and resistant and specially developed for tough everyday working conditions
- Made in Europe and 5-year guarantee¹⁾

LEDDriving® Cube PX3500 Wide

A 12 V and 24 V suitable working light that features a wide beam pattern and a power level of 3 500 lm.



Features

- WIDE BEAM = Designed for a near-field illumination
- Up to 55 m long light beam and a power level of 3 500 lm
- Efficient reflector lens design with powerful OSRAM LEDs
- Protection classes: IP6K8 & IP6K9K

Benefits

- Designed to meet the highest OE standards and requirements of the automotive industry
- Various mounting options: Direct mounting, flexible standard mounting, and heavy-duty mounting
- Robust and resistant and specially developed for tough everyday working conditions
- Made in Europe and 5-year guarantee¹⁾

LEDDriving® Cube PX4500 Wide

A 12 V and 24 V suitable working light that features a wide beam pattern and a power level of 4 500 lm.



Features

- WIDE BEAM = Designed for a near-field illumination
- Up to 60 m long light beam and a power level of 4 500 lm
- Efficient reflector lens design with powerful OSRAM LEDs
- Protection classes: IP6K8 & IP6K9K

Benefits

- Designed to meet the highest OE standards and requirements of the automotive industry
- Various mounting options: Direct mounting, flexible standard mounting, and heavy-duty mounting
- Robust and resistant and specially developed for tough everyday working conditions
- Made in Europe and 5-year guarantee¹⁾

LEDDriving® Cube PX1500 Flood

A 12 V and 24 V suitable working light that features a flood beam pattern and a power level of 1 500 lm.



Features

- FLOOD BEAM = Beam pattern for a wide and broad distribution of high beam light
- Up to 70 m long light beam and a power level of 1 500 lm
- Efficient reflector lens design with powerful OSRAM LEDs
- Protection classes: IP6K8 & IP6K9K

Benefits

- Designed to meet the highest OE standards and requirements of the automotive industry
- Various mounting options: Direct mounting, flexible standard mounting, and heavy-duty mounting
- Robust and resistant and specially developed for tough everyday working conditions
- Made in Europe and 5-year guarantee¹⁾

LEDDriving® Cube PX2500 Flood

A 12 V and 24 V suitable working light that features a flood beam pattern and a power level of 2 500 lm.



Features

- FLOOD BEAM = Beam pattern for a wide and broad distribution of high beam light
- Up to 80 m long light beam and a power level of 2 500 lm
- Efficient reflector lens design with powerful OSRAM LEDs
- Protection classes: IP6K8 & IP6K9K

Benefits

- Designed to meet the highest OE standards and requirements of the automotive industry
- Various mounting options: Direct mounting, flexible standard mounting, and heavy-duty mounting
- Robust and resistant and specially developed for tough everyday working conditions
- Made in Europe and 5-year guarantee¹⁾

LEDDriving® Cube PX3500 Flood

A 12 V and 24 V suitable working light that features a flood beam pattern and a power level of 3 500 lm.



Features

- FLOOD BEAM = Beam pattern for a wide and broad distribution of high beam light
- Up to 95 m long light beam and a power level of 3 500 lm
- Efficient reflector lens design with powerful OSRAM LEDs
- Protection classes: IP6K8 & IP6K9K

Benefits

- Designed to meet the highest OE standards and requirements of the automotive industry
- Various mounting options: Direct mounting, flexible standard mounting, and heavy-duty mounting
- Robust and resistant and specially developed for tough everyday working conditions
- Made in Europe and 5-year guarantee¹⁾

LEDDriving® Cube PX4500 Flood

A 12 V and 24 V suitable working light that features a flood beam pattern and a power level of 4 500 lm.



Features

- FLOOD BEAM = Beam pattern for a wide and broad distribution of high beam light
- Up to 105 m long light beam and a power level of 4 500 lm
- Efficient reflector lens design with powerful OSRAM LEDs
- Protection classes: IP6K8 & IP6K9K

Benefits

- Designed to meet the highest OE standards and requirements of the automotive industry
- Various mounting options: Direct mounting, flexible standard mounting, and heavy-duty mounting
- Robust and resistant and specially developed for tough everyday working conditions
- Made in Europe and 5-year guarantee¹⁾

¹⁾ For precise conditions please refer to www.osram.com/am-guarantee.

¹⁾ For precise conditions please refer to www.osram.com/am-guarantee.

LEDDriving® Cube PX1500 Spot



A 12 V and 24 V suitable working light that features a spot beam pattern and a power level of 1 500 lm.

Features

- SPOT BEAM = Beam pattern for particularly focused high beam distribution
- Up to 110 m long light beam and a power level of 1 500 lm
- Efficient reflector lens design with powerful OSRAM LEDs
- Protection classes: IP6K8 & IP6K9K

Benefits

- Designed to meet the highest OE standards and requirements of the automotive industry
- Various mounting options: Direct mounting, flexible standard mounting, and heavy-duty mounting
- Robust and resistant and specially developed for tough everyday working conditions
- Made in Europe and 5-year guarantee¹⁾

LEDDriving® Cube PX2500 Spot



A 12 V and 24 V suitable working light that features a spot beam pattern and a power level of 2 500 lm.

Features

- SPOT BEAM = Beam pattern for particularly focused high beam distribution
- Up to 140 m long light beam and a power level of 2 500 lm
- Efficient reflector lens design with powerful OSRAM LEDs
- Protection classes: IP6K8 & IP6K9K

Benefits

- Designed to meet the highest OE standards and requirements of the automotive industry
- Various mounting options: Direct mounting, flexible standard mounting, and heavy-duty mounting
- Robust and resistant and specially developed for tough everyday working conditions
- Made in Europe and 5-year guarantee¹⁾

LEDDriving® Cube PX3500 Spot



A 12 V and 24 V suitable working light that features a spot beam pattern and a power level of 3 500 lm.

Features

- SPOT BEAM = Beam pattern for particularly focused high beam distribution
- Up to 165 m long light beam and a power level of 3 500 lm
- Efficient reflector lens design with powerful OSRAM LEDs
- Protection classes: IP6K8 & IP6K9K

Benefits

- Designed to meet the highest OE standards and requirements of the automotive industry
- Various mounting options: Direct mounting, flexible standard mounting, and heavy-duty mounting
- Robust and resistant and specially developed for tough everyday working conditions
- Made in Europe and 5-year guarantee¹⁾

LEDDriving® Cube PX4500 Spot



A 12 V and 24 V suitable working light that features a spot beam pattern and a power level of 4 500 lm.

Features

- SPOT BEAM = Beam pattern for particularly focused high beam distribution
- Up to 185 m long light beam and a power level of 4 500 lm
- Efficient reflector lens design with powerful OSRAM LEDs
- Protection classes: IP6K8 & IP6K9K

Benefits

- Designed to meet the highest OE standards and requirements of the automotive industry
- Various mounting options: Direct mounting, flexible standard mounting, and heavy-duty mounting
- Robust and resistant and specially developed for tough everyday working conditions
- Made in Europe and 5-year guarantee¹⁾

OSRAM LEDDriving® Professional series (PX)

Name	Product number	EAN	No. Of LED	V	W	Max Lumen output	(m) @1 Lux	K	IP	ECE	Product weight net (g)
Cube PX1500 Ultra Wide	LEDPWL 113-UW	4062172279642	6	12/24	15	1500	40	6000	IP6K8, IP6K9K	R10	655
Cube PX2500 Ultra Wide	LEDPWL 101-UW	4062172279406	6	12/24	27	2500	55	6000	IP6K8, IP6K9K	R10	676
Cube PX3500 Ultra Wide	LEDPWL 102-UW	4062172279420	6	12/24	33	3500	65	6000	IP6K8, IP6K9K	R10	700
Cube PX4500 Ultra Wide	LEDPWL 103-UW	4062172279444	6	12/24	45	4500	70	6000	IP6K8, IP6K9K	R10	702
Cube PX1500 Wide	LEDPWL 114-WD	4062172279666	6	12/24	15	1500	35	6000	IP6K8, IP6K9K	R10	653
Cube PX2500 Wide	LEDPWL 104-WD	4062172279468	6	12/24	27	2500	45	6000	IP6K8, IP6K9K	R10	671
Cube PX3500 Wide	LEDPWL 105-WD	4062172279482	6	12/24	33	3500	55	6000	IP6K8, IP6K9K	R10	697
Cube PX4500 Wide	LEDPWL 106-WD	4062172279505	6	12/24	45	4500	60	6000	IP6K8, IP6K9K	R10	698
Cube PX1500 Flood	LEDPWL 115-FL	4062172279680	6	12/24	15	1500	70	6000	IP6K8, IP6K9K	R10	649
Cube PX2500 Flood	LEDPWL 107-FL	4062172279529	6	12/24	27	2500	80	6000	IP6K8, IP6K9K	R10	670
Cube PX3500 Flood	LEDPWL 108-FL	4062172279543	6	12/24	33	3500	95	6000	IP6K8, IP6K9K	R10	694
Cube PX4500 Flood	LEDPWL 109-FL	4062172279567	6	12/24	45	4500	105	6000	IP6K8, IP6K9K	R10	698
Cube PX1500 Spot	LEDPWL 116-SP	4062172279703	6	12/24	15	1500	110	6000	IP6K8, IP6K9K	R10	653
Cube PX2500 Spot	LEDPWL 110-SP	4062172279581	6	12/24	27	2500	140	6000	IP6K8, IP6K9K	R10	673
Cube PX3500 Spot	LEDPWL 111-SP	4062172279604	6	12/24	33	3500	165	6000	IP6K8, IP6K9K	R10	697
Cube PX4500 Spot	LEDPWL 112-SP	4062172279628	6	12/24	45	4500	185	6000	IP6K8, IP6K9K	R10	699

¹⁾ For precise conditions please refer to www.osram.com/am-guarantee.



2 Value series

For demanding work environments

The Value Series is designed to offer proven quality and increased vision for forward and rear applications at an economical price. The OSRAM LEDriving® Value series lights intensely illuminate the road and surroundings with ease. These robust and long-lasting lights were developed with a range of lighting profiles, including spot, wide or flood beam patterns for powerful far-field and near-field illumination.



Working light application:
Versatile applicable and flexible in use.



Robust and vibration resistant:
Specially designed for demanding work environments.



IP- & IK-Protection classes:
Tested and validated in our DIN certified environmental simulation laboratory for extreme external influences regarding water, dust, impacts, heat, cold and permanent vibration.

1) For precise conditions please refer to www.osram.com/am-guarantee.

LEDriving® Flush Mount WL VX100-FL



A LED Flush Mount that seamlessly integrates into the vehicle's design and is offering enhanced visibility.

Features

- FLOOD BEAM = Beam pattern for a wide and broad distribution of high beam light
- Up to 45 m long light beam and a power level of up to 600 lm
- Lightweight rugged construction and sleek shape
- Protection classes: IP6K8 & IP6K9K

Benefits

- Compact and robust - shatterproof polycarbonate lens and aluminum die-cast housing
- Standard brackets included
- 2-year guarantee¹⁾

LEDriving® Round WL VX80-WD



A 12 V and 24 V suitable working light with approved rear application.

Features

- WIDE BEAM = Designed for a near-field illumination
- Up to 43 m long light beam and a power level of up to 1 350 lm
- Approved rear application (ECE R148)
- Protection classes: IP6K8 & IP6K9K

Benefits

- Compact and robust - shatterproof polycarbonate lens and aluminum die-cast housing
- Standard brackets included
- 2-year guarantee¹⁾

LEDriving® Cube WL VX80-WD



A 12 V and 24 V suitable working light with approved rear application.

Features

- WIDE BEAM = Designed for a near-field illumination
- Up to 47 m long light beam and a power level of up to 1 350 lm
- Approved rear application (ECE R148)
- Protection classes: IP6K8 & IP6K9K

Benefits

- Compact and robust - shatterproof polycarbonate lens and aluminum die-cast housing
- Standard brackets included
- 2-year guarantee¹⁾

LEDriving® Round WL VX100-WD



A 12 V and 24 V suitable working light with approved rear application.

Features

- WIDE BEAM = Designed for a near-field illumination
- Up to 54 m long light beam and a power level of up to 2 000 lm
- Approved rear application (ECE R148)
- Protection classes: IP6K8 & IP6K9K

Benefits

- Compact and robust - shatterproof polycarbonate lens and aluminum die-cast housing
- Standard brackets included
- 2-year guarantee¹⁾

1) For precise conditions please refer to www.osram.com/am-guarantee.

**LEDDriving®
Cube WL VX100-WD**

A 12 V and 24 V suitable working light with approved rear application.



Features

- WIDE BEAM = Designed for a near-field illumination
- Up to 56 m long light beam and a power level of up to 2 000 lm
- Approved rear application (ECE R148)
- Protection classes: IP6K8 & IP6K9K

Benefits

- Compact and robust - shatterproof polycarbonate lens and aluminum die-cast housing
- Standard brackets included
- 2-year guarantee¹⁾

**LEDDriving®
Cube WL VX125-WD**

A 12 V and 24 V suitable working light for near-field illumination.



Features

- WIDE BEAM = Designed for a near-field illumination
- Up to 67 m long light beam and a power level of up to 3 000 lm
- Brilliantly white light with 6 000 K
- Protection classes: IP6K8 & IP6K9K

Benefits

- Compact and robust - shatterproof polycarbonate lens and aluminum die-cast housing
- Standard brackets included
- 2-year guarantee¹⁾

**LEDDriving®
Lightbar WL VX150-WD**

A 12 V and 24 V suitable working light for near-field illumination.



Features

- WIDE BEAM = Designed for a near-field illumination
- Up to 45 m long light beam and a power level of up to 1 500 lm
- Brilliantly white light with 6 000 K
- Protection classes: IP6K8 & IP6K9K

Benefits

- Compact and robust - shatterproof polycarbonate lens and aluminum die-cast housing
- Standard brackets included
- 2-year guarantee¹⁾

**LEDDriving®
Cube WL VX80-SP**

A 12 V and 24 V suitable working light for near-field illumination.



Features

- SPOT BEAM = Beam pattern for particularly focused high beam distribution
- Up to 114 m long light beam and a power level of up to 1 300 lm
- Brilliantly white light with 6 000 K
- Protection class: IP6K7

Benefits

- Compact and robust - shatterproof polycarbonate lens and aluminum die-cast housing
- Standard brackets included
- 2-year guarantee¹⁾

**LEDDriving®
Round WL VX70-SP**

A 12 V and 24 V suitable working light for near-field illumination.



Features

- SPOT BEAM = Beam pattern for particularly focused high beam distribution
- Up to 53 m long light beam and a power level of up to 550 lm
- Brilliantly white light with 6 000 K
- Protection class: IP6K7

Benefits

- Compact and robust - shatterproof polycarbonate lens and aluminum die-cast housing
- Standard brackets included
- 2-year guarantee¹⁾

**LEDDriving®
Cube WL VX70-WD**

A 12 V and 24 V suitable working light for near-field illumination.



Features

- WIDE BEAM = Designed for a near-field illumination
- Up to 43 m long light beam and a power level of up to 550 lm
- Brilliantly white light with 6 000 K
- Protection class: IP6K7

Benefits

- Compact and robust - shatterproof polycarbonate lens and aluminum die-cast housing
- Standard brackets included
- 2-year guarantee¹⁾

OSRAM LEDDriving® Value series (VX)

Name	Product number	EAN	No. Of LED	V	W	Max Lumen output	(m) @1 Lux	K	IP	ECE	Product weight net (g)
Flush Mount WL VX100-FL	LEDFLUSH101-FL	4062172399920	2	12/24	7	600	45	6000	IP6K8, IP6K9K	R10	230
Round WL VX80-WD	LEDWL104-WD	4062172355100	4	12/24	12	1350	43	6000	IP6K8, IP6K9K	R10, R148	244
Cube WL VX80-WD	LEDWL105-WD	4062172355124	4	12/24	12	1350	47	6000	IP6K8, IP6K9K	R10, R148	256
Round WL VX100-WD	LEDWL106-WD	4062172355148	6	12/24	20	2000	54	6000	IP6K8, IP6K9K	R10, R148	430
Cube WL VX100-WD	LEDWL107-WD	4062172355162	6	12/24	20	2000	56	6000	IP6K8, IP6K9K	R10, R148	450
Cube WL VX125-WD	LEDWL108-WD	4062172355186	9	12/24	30	3000	67	6000	IP6K8, IP6K9K	R10	670
Lightbar WL VX150-WD	LEDWL109-WD	4062172355209	6	12/24	15	1500	45	6000	IP6K8, IP6K9K	R10	358
Cube WL VX80-SP	LEDWL101-SP	4062172141970	4	12/24	20	1300	114	6000	IP6K7	R10	1090
Round WL VX70-SP	LEDWL102-SP	4062172150699	5	12/24	20	550	53	6000	IP6K7	R10	450
Cube WL VX70-WD	LEDWL103-WD	4062172142021	5	12/24	24	550	43	6000	IP6K7	R10	540

1) For precise conditions please refer to www.osram.com/am-guarantee.

1) For precise conditions please refer to www.osram.com/am-guarantee.

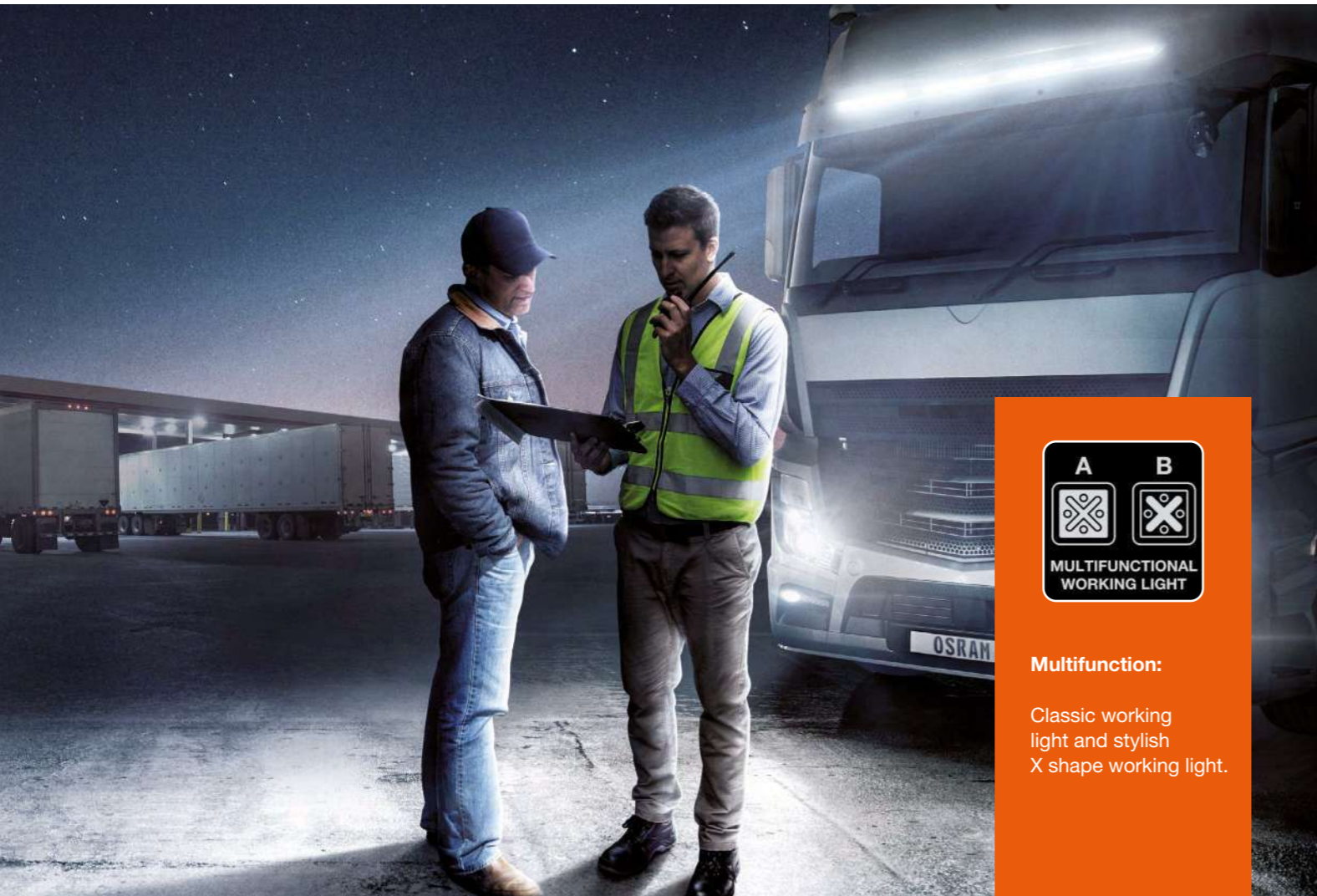

Multifunction:
Classic working light and stylish X shape working light.

3 Multifunctional series

Powerful LED working lights

With two light functions, the OSRAM Multifunctional series combines power with practicality. Choose between the classic LED working light and the stylish X shape LED working light. Now you can explore further than ever before, safe in the knowledge that OSRAM will light the way.



Working light application:
Versatile applicable and flexible in use.



Robust and vibration resistant:
Specially designed for demanding work environments.



IP- & IK-Protection classes:
Tested and validated in our DIN certified environmental simulation laboratory for extreme external influences regarding water, dust, impacts, heat, cold and permanent vibration.

LEDDriving® Cube MX85-SP



A 12 V suitable working light for far-field illumination with a stylish X shape design.

Features

- SPOT BEAM = Beam pattern for particularly focused high beam distribution
- Up to 110 m long light beam and a power level of up to 1 250 lm
- Two light functions: classic working light and the stylish X shape LED working light
- Protection class: IP6K7

Benefits

- Compact and robust - shatterproof polycarbonate lens and aluminum die-cast housing
- Improved view and visibility in low light conditions
- 5-year guarantee¹⁾

LEDDriving® Cube MX85-WD



A 12 V suitable working light for near-field illumination with a stylish X shape design.

Features

- WIDE BEAM = Designed for a near-field illumination
- Up to 55 m long light beam and a power level of up to 1 250 lm
- Two light functions: classic working light and the stylish X shape LED working light
- Protection class: IP6K7

Benefits

- Compact and robust - shatterproof polycarbonate lens and aluminum die-cast housing
- Improved view and visibility in low light conditions
- 5-year guarantee¹⁾

OSRAM LEDDriving® Multifunctional series (MX)

Name	Product number	EAN	No. Of LED	V	W	Max Lumen output	(m) @1 Lux	K	IP	ECE	Product weight net (g)
Cube MX85-SP	LEDDL101-SP	4052899595255	4	12	20	1250	110	6000	IP6K7	R10	500
Cube MX85-WD	LEDDL101-WD	4052899595279	4	12	20	1250	55	6000	IP6K7	R10	500

¹⁾ For precise conditions please refer to www.osram.com/am-guarantee.

Reversing light application:

Versatile applicable and flexible in use.

4 Functional series

For versatile applications

LEDDriving® Functional series offer powerful near field illumination and are versatile applicable. These robust working lights are approved as reversing lights and come in different shapes.



Robust and vibration resistant:
Specially designed for demanding work environments.



IP- & IK-Protection classes:
Tested and validated in our DIN certified environmental simulation laboratory for extreme external influences regarding water, dust, impacts, heat, cold and permanent vibration.



Guarantee:
5-year OSRAM guarantee.¹⁾

¹⁾ For precise conditions please refer to www.osram.com/am-guarantee.

LEDDriving® Reversing FX120R-WD



A 12 V and 24 V suitable working light for near-field illumination, that is approved as a reversing light.

Features

- WIDE BEAM = Designed for a near-field illumination
- Up to 36 m long light beam and a power level of up to 1 100 lm
- Approved reversing light (ECE R23)
- Protection class: IP69K

Benefits

- Robust and resistant and specially developed for tough everyday working conditions
- Improved view and visibility in low light conditions
- 5-year guarantee¹⁾

LEDDriving® Reversing FX120S-WD



A 12 V and 24 V suitable working light for near-field illumination, that is approved as a reversing light.

Features

- WIDE BEAM = Designed for a near-field illumination
- Up to 36 m long light beam and a power level of up to 1 100 lm
- Approved reversing light (ECE R23)
- Protection class: IP69K

Benefits

- Robust and resistant and specially developed for tough everyday working conditions
- Improved view and visibility in low light conditions
- 5-year guarantee¹⁾

OSRAM LEDDriving® Functional series (FX)

Name	Product number	EAN	No. Of LED	V	W	Max Lumen output	(m) @1 Lux	K	IP	ECE	Product weight net (g)
Reversing FX120R-WD	LEDDL108-WD	4062172105712	14	12/24	15	1100	36	6000	IP69K	R10, R23	360
Reversing FX120S-WD	LEDDL109-WD	4062172105736	13	12/24	15	1100	36	6000	IP69K	R10, R23	400

¹⁾ For precise conditions please refer to www.osram.com/am-guarantee.



Easy installation:

Specially designed for easy, uncomplicated, and flexible assembly.

5 Accessories

Accessories designed for LEDDriving® working lights

To support the installation of OSRAM working lights, OSRAM has specially produced a series of matching accessories for them.



Flexible Mounting:
Particularly flexible bracket for the installation of the working lights PX.



Heavy Duty Mounting:
Particularly strong and resistant bracket for the installation of the working lights PX.



Compatibility:
Compatible with OSRAM working lights.

LEDriving® Wire Harness AX 1LS



The Wire Harness AX 1LS is suitable for the installation of one light source with one lighting function of the driving light.

Features

- Wire harness for easy installation of one light source with one light function
- On/off switch included which can be mounted in the cockpit
- Suitable for 12 V vehicles

Benefits

- Compatible with all OSRAM LEDDriving® driving and working lights
- Easy installation
- 2-year guarantee¹⁾

LEDriving® Wire Harness AX 2LS



The Wire Harness AX 2LS is suitable for the installation of two light sources with one lighting function of the driving light.

Features

- Wire harness for easy installation of two light sources with one light function
- On/off switch included which can be mounted in the cockpit
- Suitable for 12 V vehicles

Benefits

- Compatible with all OSRAM LEDDriving® driving and working lights
- Easy installation
- 2-year guarantee¹⁾

LEDriving® Mounting Kit PX



A flexible mounting kit specially designed for the working lights of the PX series.

Features

- Compatible with all OSRAM LEDDriving® working lights Professional series
- Specially designed for easy, uncomplicated, and flexible assembly
- Mounting on the vehicle with only one central screw possible
- Vibration resistance: Min. 8 g rms, robust and resistant

Benefits

- Adjustable to the desired tilt angle by up to +/-15 degrees
- 360° flexible mounting
- All components are made of stainless steel
- 5-year guarantee¹⁾

LEDriving® Heavy Duty Mounting Kit PX



A heavy duty mounting kit specially designed for the working lights of the PX series.

Features

- Compatible with all OSRAM LEDDriving® working lights Professional series
- Especially developed for heavy duty vehicles
- Mounting on the vehicle with only one central screw possible
- Vibration resistance: Min. 15 g rms

Benefits

- Adjustable to the desired tilt angle by up to +/-30 degrees
- Particularly robust and resistant
- All components are made of stainless steel
- 5-year guarantee¹⁾

¹⁾ For precise conditions please refer to www.osram.com/am-guarantee.

LEDDriving®
Connection Cable 300 DT AX

A 3 m long connection cable to install the working lights of the PX series.



Features

- Compatible with all OSRAM LEDDriving® working lights PX and with LEDDriving® driving lights FX and SX
- Suitable for 12 V and 24 V vehicles
- DT Connector: DT06-2S
- Conductor material pure copper

Benefits

- Length: 3 m
- Easy installation
- To install appropriate lighting even on large vehicles
- 2-year guarantee¹⁾

OSRAM LEDDriving® Accessories (AX)

Name	Product number	EAN	V	ECE	Product weight net (g)	Cable length (mm)
Wire Harness AX 1LS	LEDDL ACC 101	4062172147682	12	-	275	2550
Wire Harness AX 2LS	LEDDL ACC 102	4062172147729	12	-	348	3400
Mounting Kit PX	LEDPWL ACC 101	4062172294768	-	R10	174	-
Heavy Duty Mounting Kit PX	LEDPWL ACC 102	4062172294782	-	R10	305	-
Connection Cable 300 DT AX	LEDPWL ACC 103	4062172294805	12/24	R10	249	3000

The night doesn't stand a chance
Versatility comes in all shapes and sizes

The OSRAM LEDDriving® working lights are robust and compact, combining extremely high optic efficiency with even light distribution and a glare-reducing reflector design. The working light are available in a variety of performances, shapes, and beam patterns, plus a choice of illumination profiles like flood, spot, wide and ultra-wide.¹⁾



¹⁾ For precise conditions please refer to www.osram.com/am-guarantee.

¹⁾ Additional working lights without ECE approval for use as work lights are approved for use on any vehicle according to German Road Traffic Licensing Regulations (StVZO) §52 (7). However, they must not be used and switched on while driving. In addition, individual special regulations, and laws of countries outside Germany must be observed.

Useful information for end-users

OSRAM LEDriving® working lights have been designed and engineered for a wide range of applications. Each headlight features one of five light beam types to give you maximum visibility exactly where you need it.

Product name – key to its features

Can you decipher the symbol ROUND WL VX100-WD? If not, read our mini-guide and learn the meanings of the product symbols in our brochure.

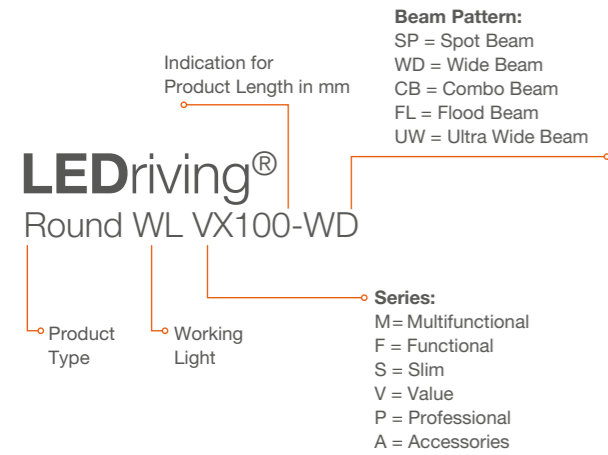

Spot beam:

A spot beam pattern is designed, manufactured and intended for far-field illumination. The reflector design focuses the light beam to a light spot in the far field of the vehicle.

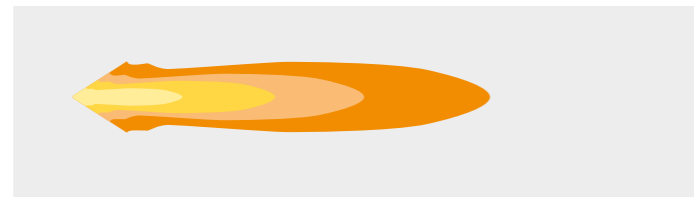

Flood Beam:

A flood beam is designed for near-field illumination. The reflector distributes the light over a large area in the near field of the vehicle.



Wide beam:

A wide beam pattern is designed, manufactured and intended for near-field illumination. The reflector distributes the light widely in the near field around the vehicle.



Ultra Wide Beam:

An Ultra Wide Beam is intended for close-range illumination. With an extra wide light cone, the reflector provides particularly extensive illumination in the vehicle's near field.

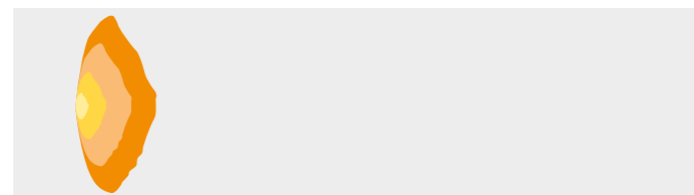

Combo beam:

A combo-beam is designed for both far-field and near-field illumination. The reflector combines a spot and wide beam to achieve wide illumination in the near field and punctual in the far field.

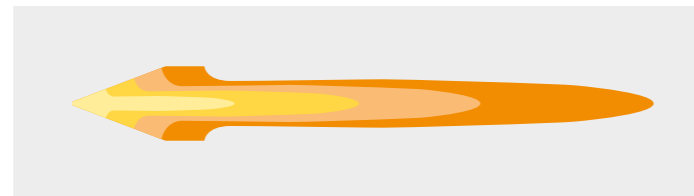

OSRAM LED Working Lights – Measurements

Professional series



Professional series

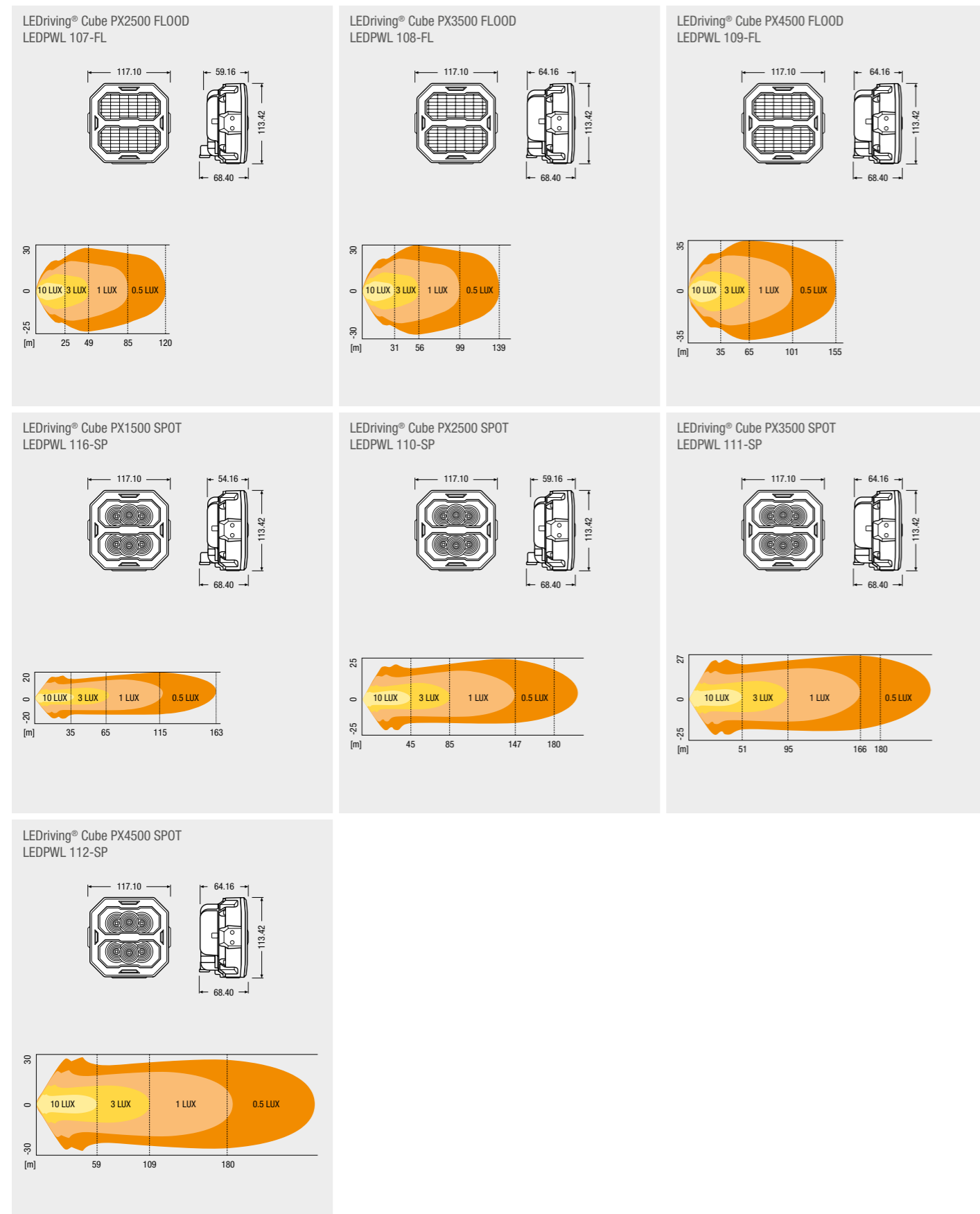

Value series

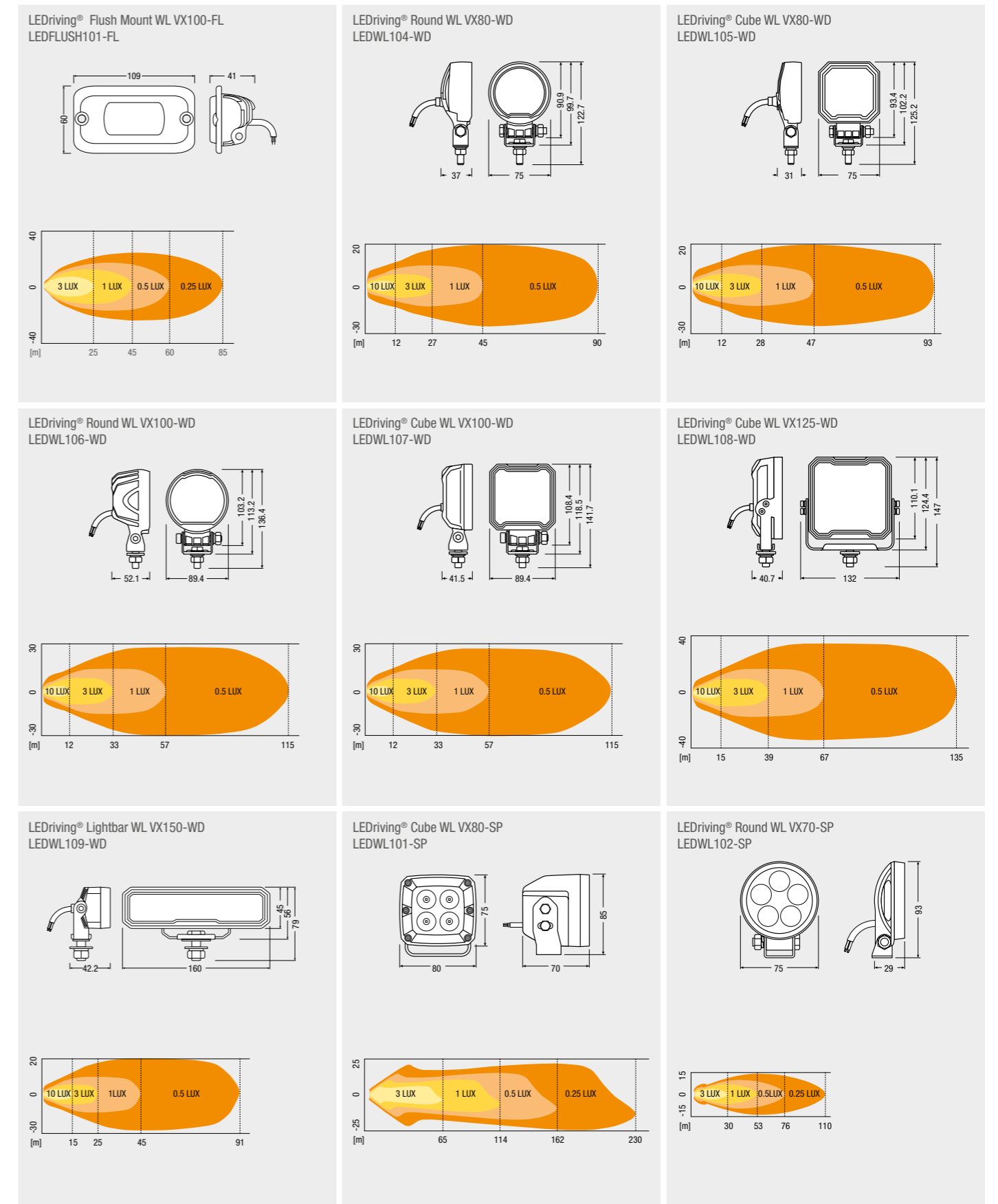

Value series

Multifunctional series

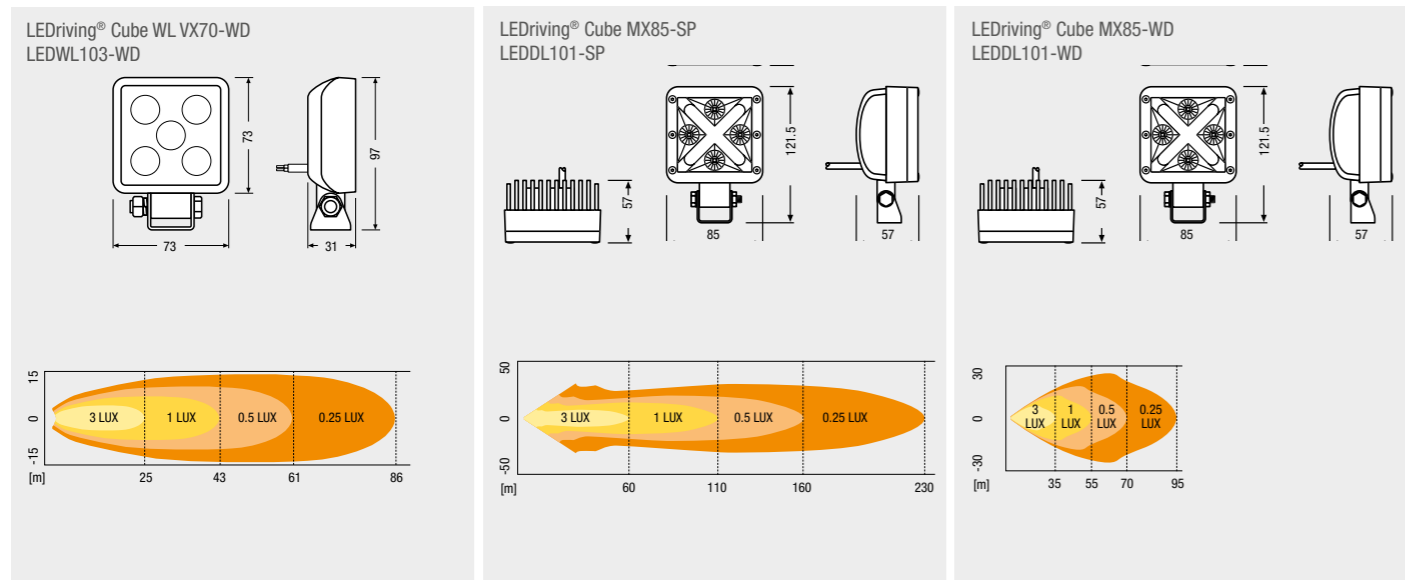

Functional series

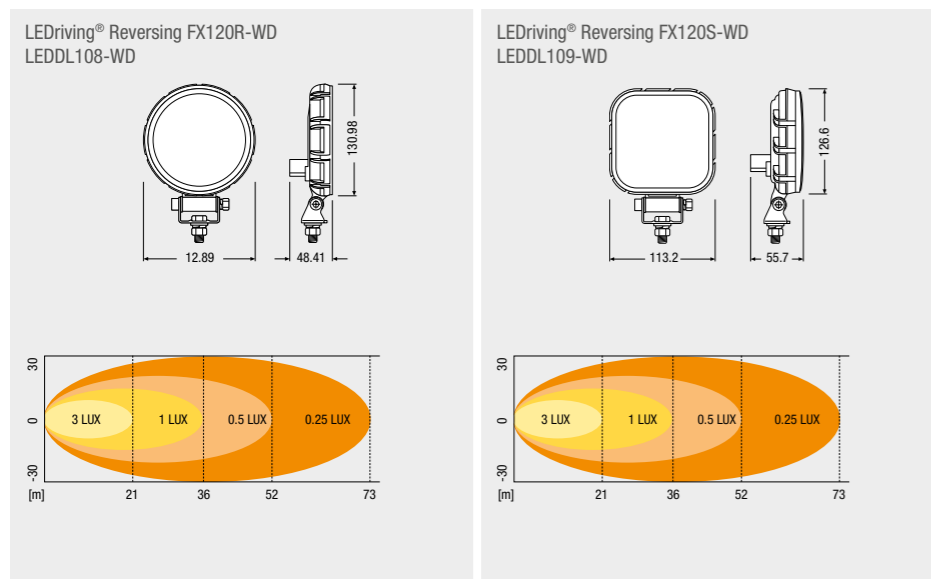

Accessories

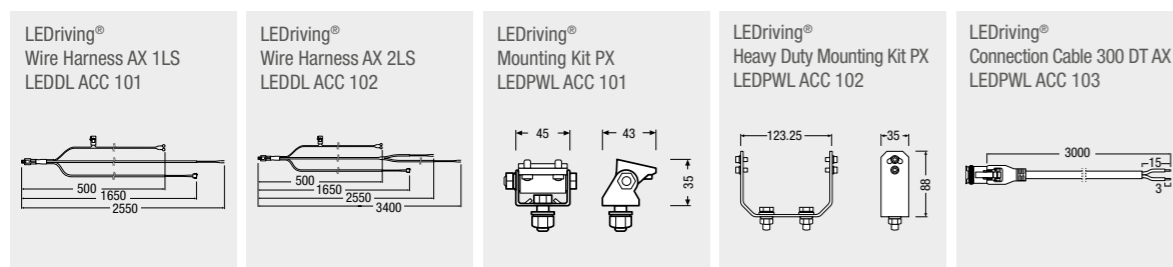

Advantages of OSRAM Guarantee

OSRAM products are innovative and technologically high-quality products that are carefully-tested and subject to the strict monitoring undertaken by the OSRAM quality assurance system. LEDiving® working lights are backed by up to 5-year guarantee from OSRAM.¹⁾

Guarantee claim: Step-by-step instructions

Did you experience a defect during the guarantee period? We are sorry because this does not coincide with our quality standards! To resolve the problem, you can of course approach your dealer – or optionally you may contact us. In the latter case, it takes just five simple steps to get a replacement:

- Packing:** Pack the lamp securely for transport. Use the original packaging if you still have it.
- Include the receipt:** Include the receipt or invoice in the package (either the original or a copy) if you still have it.
- Add the completed complaint form:** Place the completed customer complaint form into the carton.
- Seal and address it:** Seal the package and address it to us. You will find the address for returns in your country on this list.
- Send the package:** Send your package to us – please affix correct postage. We will take care of the problem as quickly as possible!

The list of the OSRAM LEDiving® Working Lights series covered by a 5-year or 2-year guarantee can be found here:
www.osram.com/am-guarantee

¹⁾ 5-year guarantee for FX, MX and PX series. 2-year guarantee for VX and AX series. Refer to www.osram.com/am-guarantee for precise conditions.



OSRAM-quality guaranteed

All OSRAM products are extensively stress tested by our quality assurance system. For information concerning guarantees, visit www.osram.com/am-guarantee or scan the QR code.

1

LEDriving® Headlights

You have a number of options for enhancement of your original OEM headlights, dependent on which model you drive. We offer full LED headlights and powerful xenon headlights combined with LED daytime running lights to replace halogen bulbs.



2

LEDriving® Dynamic Mirror Indicators

Fully dynamic LED mirror turn signal with OSRAM LEDs for different car models. There are two editions to choose from: Black and white edition.



3

LEDriving® Tail Lights

The LED tail lights feature LED position light, LED stop light and dynamic LED indicator and are available for VW Golf VI and Ford Fiesta.



LED Fixtures

Bringing style and performance to life

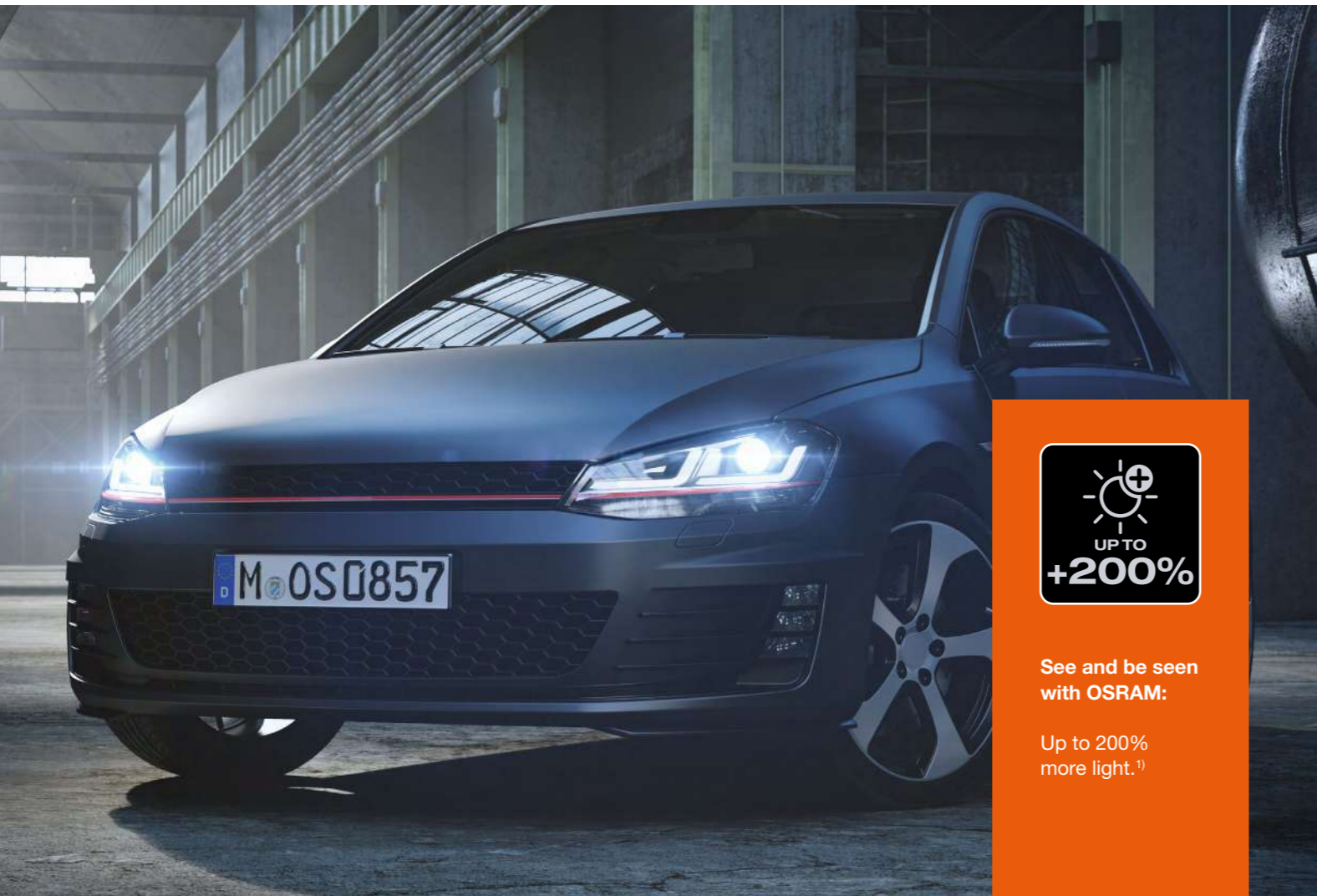

See and be seen with OSRAM:

Up to 200% more light.¹⁾

1 LEDDriving® Headlights

High efficiency meets extreme effectiveness

When it comes to quality and performance there is no compromise. Upgrading your lights also means upgrading your road safety, because you'll be able to see and be seen better. The range of options available to you includes full LED headlights as well as XENON/LED headlights – dependent on the model of car you drive. But every option gives you access to the very latest technology and increases the light performance of your vehicle – unlike traditional halogen lights that take a few seconds to reach their full potential.

UP TO 200M
Up to 200 m long light beam:
 More light allows to see farther and therefore react sooner.

6500 KELVIN
Brilliantly white light:
 Exceptional illumination, performance, quality, shape, durability and functionality.

2 YEAR OSRAM GUARANTEE
Guarantee:
 2-year OSRAM guarantee.²⁾

LEDriving® Headlights



With these headlights, OSRAM offers a solution for different car models not equipped with LED headlights. All headlights are approved for road use and are available for various car models.

Features

- OSRAM full LED head light: LED position light, LED low beam, LED high beam, LED daytime running light and dynamic LED turn indicator
- Up to 200% more light¹⁾
- Up to 100% whiter light²⁾
- Up to 200 m long light beam
- Pixel-free optics

Benefits

- Linear and homogeneous light distribution
- Plug & Play installation
- Completely legal in road traffic, ECE certified (ECE R6/R7/R48/R87/R112)
- Protection class: IP69K
- 2-year guarantee³⁾

LEDriving® Headlights

Product Reference	EAN	COLOR EDITION	W	V	IP	K	ECE	LHD/ RHD ⁴⁾			GUAR- ANTEE (YEAR)
LEDriving® Headlights for VW GOLF 7.5											
LEDHL109-BK ⁵⁾	4062172169639	Black	25	12	IP69K	6500	R06, R07, R10, R48, R87, R112	LHD	1	1	2
LEDHL109-GTI ⁵⁾	4062172169622	GTI	25	12	IP69K	6500	R06, R07, R10, R48, R87, R112	LHD	1	1	2
LEDriving® Headlights for VW GOLF VII											
LEDHL103-GTI ⁷⁾	4052899599628	GTI	36	12	IP69K	6500	R06, R07, R10, R48, R87, R112	LHD	1	1	2
LEDHL103-CM ⁷⁾	4052899599611	Chrome	36	12	IP69K	6500	R06, R07, R10, R48, R87, R112	LHD	1	1	2
LEDHL103-CM RHD ⁷⁾	4062172176026	Chrome	36	12	IP69K	6500	R06, R07, R10, R48, R87, R112	RHD	1	1	2
LEDHL103-BK ⁷⁾	4052899599598	Black	36	12	IP69K	6500	R06, R07, R10, R48, R87, R112	LHD	1	1	2
LEDHL104-GTI ⁷⁾	4052899604933	GTI	36	12	IP69K	6500	R06, R07, R10, R48, R87, R112	LHD	1	1	2
LEDHL104-CM ⁷⁾	4052899604919	Chrome	36	12	IP69K	6500	R06, R07, R10, R48, R87, R112	LHD	1	1	2
LEDHL104-BK ⁷⁾	4052899604896	Black	36	12	IP69K	6500	R06, R07, R10, R48, R87, R112	LHD	1	1	2
LEDriving® Headlights for VW Amarok											
LEDHL107-BK	4052899616240	Black	25	12	IP69K	6500	R06, R07, R10, R48, R87, R112	LHD	1	1	2
LEDHL107-BK RHD	4062172176033	Black	25	12	IP69K	6500	R06, R07, R48, R87, R98, R10	RHD	1	1	2
LEDriving® Headlights for BMW 1ER F20/F21											
LEDHL108-BK ⁸⁾	4062172120333	Black	32	12	IP69K	6500	R06, R07, R10, R48, R87, R112	LHD	1	1	2
LEDHL108-CM ⁸⁾	4062172120340	Chrome	32	12	IP69K	6500	R06, R07, R10, R48, R87, R112	LHD	1	1	2

1) Compared to ECE R 112 minimum requirements. 2) For precise conditions please refer to www.osram.com/am-guarantee.

1) Compared to minimum ECE R112 requirements. 2) Compared to standard headlights with halogen lamp. 3) For precise conditions please refer to www.osram.com/am-guarantee. 4) LHD: Left Hand Drive; RHD: Right Hand Drive. 5) Suitable for VW Golf VII Facelift with original equipment halogen headlights. 6) Not suitable for VW Golf VII Facelift with original equipment xenon headlights. 7) Only suitable for VW Golf VII car models with OEM halogen or OEM xenon-headlights with halogen daytime running light. 8) Suitable for BMW 1 Series with original equipment halogen headlights. 9) Not suitable for BMW 1 Series with original equipment xenon headlights.

LEDiving® XENARC® Headlights



With its outstanding design, the LEDiving® XENARC® headlights combine modern LED daytime running light functionality with a powerful xenon lamp.

Features

- Up to 70% more light¹⁾
- Up to 40% whiter light²⁾
- Up to 200 m long light beam
- ECE certified with extra lifetime
- More light allows to see farther and therefore react sooner thanks to pixel-free optic

Benefits

- High contrast and brilliantly cool white LED light for the most stylish look on the road
- No additional beam level adjustment and headlight cleaning system required, as well as no additional parts and no registration needed for installation
- Protection class: IP69K
- 2-year guarantee³⁾

LEDiving® XENARC® Headlights

Product Reference	EAN	COLOR EDITION	W	V	IP	K	ECE	LHD/RHD ⁴⁾			GUARANTEE (YEAR)
-------------------	-----	---------------	---	---	----	---	-----	-----------------------	--	--	------------------

LEDiving® XENARC® Headlights for Ford Focus 3

LEDHL105-BK ⁵⁾	4052899600997	Black	55	12	IP69K	6000	R06, R07, R10, R48, R87, R98	LHD	1	1	2
---------------------------	---------------	-------	----	----	-------	------	------------------------------	-----	---	---	---

LEDiving® XENARC® Headlights for VW Golf VI

LEDHL102-BK	4052899982123	Black	25	12	IP69K	6000	R06, R07, R48, R87, R98, R10	LHD	1	1	2
LEDHL102-BK RHD	4052899519404	Black	25	12	IP69K	6000	R06, R07, R48, R87, R98, R10	RHD	1	1	2
LEDHL102-GTI	4052899982123	GTI	25	12	IP69K	6000	R06, R07, R10, R48, R87, R112	LHD	1	1	2
LEDHL102-CM	4052899982147	Chrome	25	12	IP69K	6000	R06, R07, R10, R48, R87, R112	LHD	1	1	2

LEDiving® Universal Headlights



The four universal headlights in total offer superior illumination, performance, and quality. They are available for left hand drive and right hand drive.

Features

- LED high and low beam projector (LEDUHL103/104) with optional Position Light and Daytime Running Light function (LEDUHL101/102)
- Available for left-hand drive (LEDUHL101/LEDUHL103) and right-hand drive (LEDUHL102/LEDUHL104)
- Brilliantly white light with up to 6 500 K

Benefits

- Three mounting possibilities: Direct mount, with mounting plate and levelling motor
- ECE-Compliant
- For 12 V & 24 V vehicles
- Highest protection classes according to IP6K7 & IP6K9K
- Made in Europe
- 2-year guarantee³⁾

LEDiving® Universal Headlight

Product Reference	EAN	COLOR EDITION	W	V	IP	K	ECE	LHD/RHD ⁴⁾			GUARANTEE (YEAR)
LEDUHL101	4062172219358	-	34	12/24	IP6K9K, IP6K7	5400-6500	R112, R87, R10, R7	LHD	1	1	2
LEDUHL102	4062172239011	-	34	12/24	IP6K9K, IP6K7	5400-6500	R112, R87, R10, R7	RHD	1	1	2
LEDUHL103	4062172219556	-	28	12/24	IP6K9K, IP6K7	5400-6500	R112, R10	LHD	1	1	2
LEDUHL104	4062172238991	-	28	12/24	IP6K9K, IP6K7	5400-6500	R112, R10	RHD	1	1	2
LEDUHL MOUNT101	4062172302449	-	-	-	-	-	-	-	1	1	2

1) Compared to minimum ECE R112 requirements. 2) Compared to standard headlights with halogen lamp. 3) For precise conditions please refer to www.osram.com/am-guarantee. 4) LHD: Left Hand Drive; RHD: Right Hand Drive. 5) Only suitable for Ford Focus 3 cars with OEM halogen headlights.



High contrast day and night:

Fully dynamic LED mirror turn signal with OSRAM LEDs.

2 LEDiving® Dynamic Mirror Indicators

Turn heads while turning corners

Signal your intentions with the indicator lights. Integrated into your car's mirror housing, these sophisticated LED lights offer up to 200% more brightness compared to the minimum ECE R6 requirements. With high contrast in darkness and daylight, they offer uniform light distribution across the indicator surface. Best of all the Plug & Play design means they require, on average, just 15 minutes to fit. The products are approved for road use without having to be registered (ECE certified according to ECE R6/R10).



Up to 200% more brightness:¹⁾
High contrast day and night due to intensive yellow LED light.²⁾



Plug & Play:
Quick and uncomplicated modification and installation.



Synchronous to LED headlights:
For the full effect, OSRAM LEDiving® DMI indicators work synchronously with OSRAM LED headlights.

1) Compared to the minimum requirements of ECE R6. 2) Compared to other mirror indicators.

LEDiving® Dynamic Mirror Indicators

These fully dynamic LED mirror indicators offer an innovative design to impressively complement the individual look of your vehicle. They are available for different car models.



Features

- Up to 200% more brightness¹⁾
- High-performance long-life LEDs
- Plug & Play Installation
- Black & White Edition
- ECE certified (ECE R6/R10)

Benefits

- High contrast day and night due to intensive yellow LED light²⁾
- Fully dynamic LED mirror indicator with high-performance LEDs
- Protection class: IP6K9K
- 5-year guarantee³⁾

LEDiving® Dynamic Mirror Indicator

Product Reference	EAN	COLOR EDITION	W	V	IP	K	ECE	LHD/RHD ⁴⁾			GUARANTEE (YEAR)
-------------------	-----	---------------	---	---	----	---	-----	-----------------------	--	--	------------------

LEDiving® Dynamic Mirror Indicator VW Golf 7

LEDDMI 5G0 WT S ⁵⁾	4062172046534	White	2.4	12	IP6K9K	2700	R6, R10	LHD	1	4	5
LEDDMI 5G0 BK S ⁵⁾	4062172046510	Black	3.1	12	IP6K9K	2700	R6, R10	LHD	1	4	5

LEDiving® Dynamic Mirror Indicator VW Golf 6

LEDDMI 5K0 WT S ⁵⁾	4062172149105	White	4.9	12	IP6K9K	2700	R6, R10	LHD	1	4	5
LEDDMI 5K0 BK S ⁵⁾	4062172149082	Black	4.9	12	IP6K9K	2700	R6, R10	LHD	1	4	5

LEDiving® Dynamic Mirror Indicator Passat B8

LEDDMI 3G0 WT S ⁷⁾	4062172046497	White	2.64	12	IP6K9K	2700	R6, R10	LHD	1	4	5
LEDDMI 3G0 BK S ⁷⁾	4039378742805	Black	2.64	12	IP6K9K	2700	R6, R10	LHD	1	4	5

LEDiving® Dynamic Mirror Indicator BMW F20

LEDDMI F20 WT S ⁸⁾	4062172051286	White	4.8	12	IP6K9K	2700	R6, R10	LHD	1	4	5
LEDDMI F20 BK S ⁸⁾	4062172052795	Black	4.8	12	IP6K9K	2700	R6, R10	LHD	1	4	5

LEDiving® Dynamic Mirror Indicator Leon 5F

LEDDMI 5F0 WT S ⁹⁾	4062172052757	White	2.4	12	IP6K9K	2700	R6, R10	LHD	1	4	5
LEDDMI 5F0 BK S ⁹⁾	4062172052832	Black	2.4	12	IP6K9K	2700	R6, R10	LHD	1	4	5

LEDiving® Dynamic Mirror Indicator Audi A4 B9

LEDDMI 8W0 WT S ¹⁰⁾	4062172052733	White	2.64	12	IP6K9K	2700	R6, R10	LHD	1	4	5
LEDDMI 8W0 BK S ¹⁰⁾	4062172052818	Black	2.64	12	IP6K9K	2700	R6, R10	LHD	1	4	5

LEDiving® Dynamic Mirror Indicator Audi A3 8V

LEDDMI 8V0 WT S ¹¹⁾	4062172052771	White	2.4	12	IP6K9K	2700	R6, R10	LHD	1	4	5
LEDDMI 8V0 BK S ¹¹⁾	4062172052856	Black	2.4	12	IP6K9K	2700	R6, R10	LHD	1	4	5

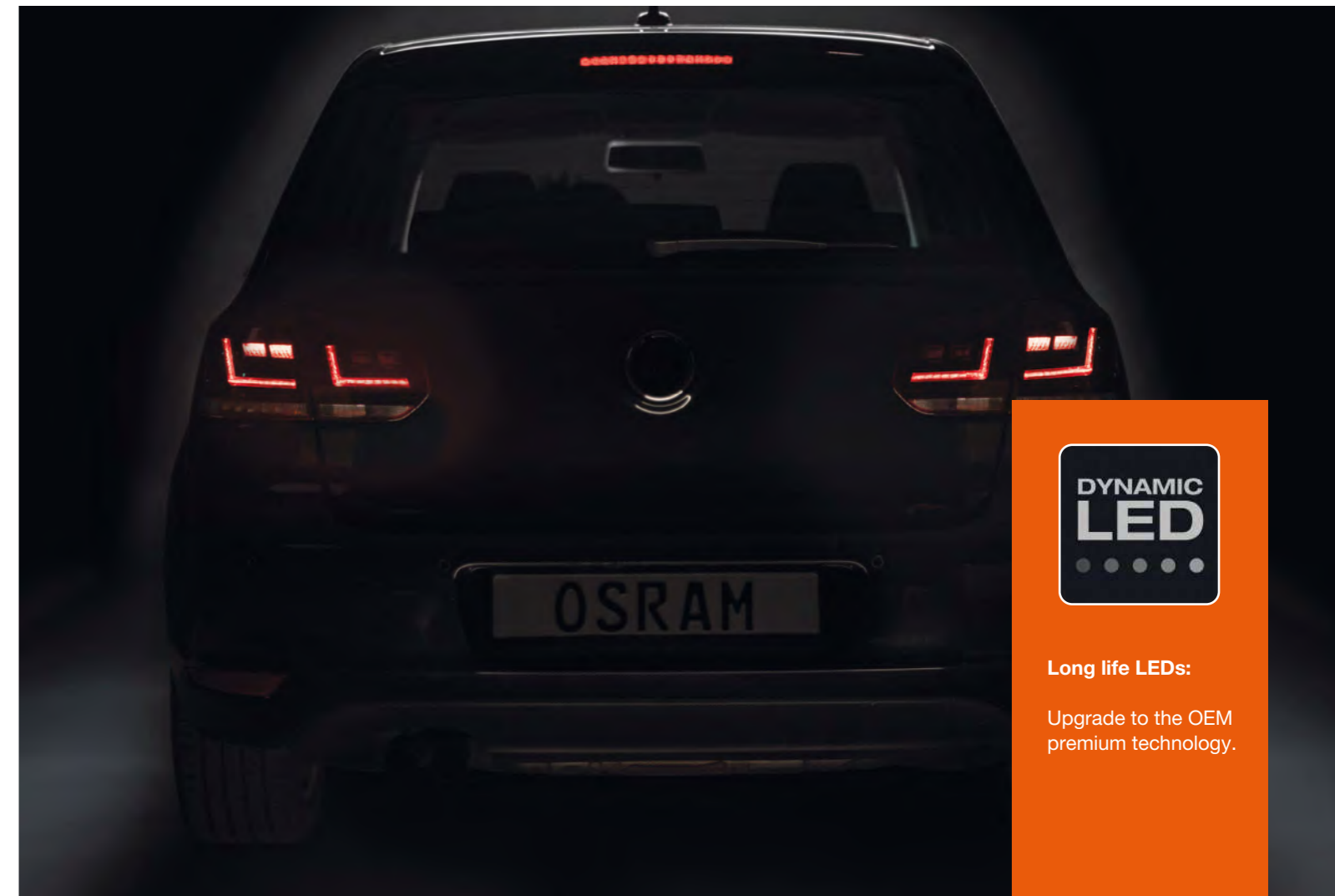

Long life LEDs:

Upgrade to the OEM premium technology.

3 LEDiving® Tail Lights

Putting your car's rear out in front

Why should the front of your car get all your attention? OSRAM's full LED tail lights¹⁾ also bring precision lighting technology to the rear of your vehicle. This fully integrated unit includes an LED position light, LED stop light, and LED indicator. With superior homogeneity thanks to its ground-breaking diffuser material, this lighting unit gives you stopping power in more ways than one.



Plug & Play:
Quick and uncomplicated modification and installation



ECE-certified:
No registration in the car documents required.



Guarantee:
2-year OSRAM guarantee.²⁾

1) Compared to minimum ECE R6 requirements. 2) Compared to other mirror indicators. 3) For precise conditions please refer to www.osram.com/am-guarantee. 4) LHD: Left Hand Drive; RHD: Right Hand Drive. 5) Suitable for Golf VII (08/2012-2016), Golf 7.5 FL (2017-), VW Touran II (05/2015-), VW Lamando (2014-2019). 6) Suitable for VW Golf VI (10/2008-08/2012), VW Touran I (5/2010-05/2015). 7) Suitable for VW Golf VIII (2019-), VW Golf VIII Var. (2019-), VW PASSAT B8 (2015-), VW Arteon (2017-), VW ID.3 (2020-), Cupra Born (2021-). 8) Suitable for BMW 1 Series: F20, F21, F52 (2011-), BMW 2 Series: F22, F23 (2014-), BMW 3 Series: F30, F31, F34, F35 (2011-2019), BMW 4 Series: F32, F33, F36 (2013-), BMW X1: E84 (2009-2015). 9) Suitable for Seat Leon 5F (2012-), Seat Ibiza KJ (2018-), Seat Arona KJ (2018-). 10) Audi A4 B9 (08/2015-), Audi S4 B9: (05/2016-), Audi RS4 B9: (09/2017-), Audi A5 F5 (10/2016-), Audi S5 F5: (07/2016-), Audi RS5 F5: (03/2017-). 11) Suitable for Audi A3 8V (08/2012-), Audi S3 8V (5/2013-), Audi RS3 8VA (4/2015-).

1) Depending on the model. 2) For precise conditions please refer to www.osram.com/am-guarantee.

LEDiving® Tail Lights

The LEDiving® tail lights bring precise lighting to the rear of your vehicle and are available for Ford Fiesta MK7 and VW Golf VI models.



Features

- OSRAM LED-tail lights
- LED position light, LED stop light, LED dynamic turn indicator
- High-performance long-life LEDs
- Up to 80% less energy consumption¹⁾
- No delayed response of the illumination

Benefits

- Easy and quick Plug & Play
- ECE certified: (ECE R6/R7/R10/R23)
- Protection class: IP69K
- 2-year guarantee²⁾

LEDiving® Tail Lights

Product Reference	EAN	COLOR EDITION	W	V	IP	K	ECE	LHD/RHD ³⁾			GUARANTEE (YEAR)
-------------------	-----	---------------	---	---	----	---	-----	-----------------------	--	--	------------------

LEDiving® Tail Lights Ford Fiesta MK7

LEDTL101-CL	4052899616257	-	27	12	IP69K	-	R6, R7, R10, R23	LHD	1	1	2
-------------	---------------	---	----	----	-------	---	------------------	-----	---	---	---

LEDiving® Tail Lights VW Golf VI

LEDTL102-CL	4052899617001	-	30	12	IP69K	-	R6, R7, R10, R23, R38, R48	LHD	1	1	2
-------------	---------------	---	----	----	-------	---	----------------------------	-----	---	---	---

OSRAM LED Fixtures – Measurements

LEDiving® Headlights
LEDHL109

LEDiving® Headlights
LEDHL103/LEDHL104

LEDiving® Headlights
LEDHL107

LEDiving® Headlights
LEDHL108

LEDiving® XENARC® Headlights
LEDDL105

LEDiving® XENARC® Headlights
LEDDL102

LEDiving® Universal Headlight
LEDUHL101/102/103/104/LEDUHL MOUNT101

LEDiving® Dynamic Mirror Indicators
LEDDMI 5G0

LEDiving® Dynamic Mirror Indicators
LEDDMI 5K0

LEDiving® Dynamic Mirror Indicators
LEDDMI 3G0

LEDiving® Dynamic Mirror Indicators
LEDDMI F20

LEDiving® Dynamic Mirror Indicators
LEDDMI 5F0

LEDiving® Dynamic Mirror Indicators
LEDDMI 8W0

LEDiving® Dynamic Mirror Indicators
LEDDMI 8V0

LEDiving® Tail Light
LEDTL101-CL

LEDiving® Tail Light
LEDTL102-CL

1) Compared to standard tail lights with halogen lamp. 2) For precise conditions please refer to www.osram.com/am-guarantee. 3) LHD: Left Hand Drive; RHD: Right Hand Drive.







Bicycle lighting, care, and equipment
Your confidence to ride, day and night

Advantages of OSRAM Guarantee

OSRAM products are innovative and technologically high-quality products that are carefully-tested and subject to the strict monitoring undertaken by the OSRAM quality assurance system. LEDSBIKE® are backed by up to 2-year guarantee from OSRAM.¹⁾

Guarantee claim: Step-by-step instructions

Did you experience a defect during the guarantee period? We are sorry because this does not coincide with our quality standards! To resolve the problem, you can of course approach your dealer – or optionally you may contact us. In the latter case, it takes just five simple steps to get a replacement:

 <p>Packing: Pack the lamp securely for transport. Use the original packaging if you still have it.</p>	 <p>Include the receipt: Include the receipt or invoice in the package (either the original or a copy) if you still have it.</p>	 <p>Add the completed complaint form: Place the completed customer complaint form into the carton.</p>
 <p>Seal and address it: Seal the package and address it to us. You will find the address for returns in your country on this list.</p>	 <p>Send the package: Send your package to us – please affix correct postage. We will take care of the problem as quickly as possible!</p>	



The list of the OSRAM LEDSBIKE® series covered by a 2-year guarantee can be found here: www.osram.com/am-guarantee

Light up your life with the leaders in light¹⁾

Brilliant brightness and premium-quality equipment

OSRAM's commitment to supporting road safety extends beyond motorists, and beyond light. Our road-ready bicycle portfolio combines automotive-quality LED lighting with a range of premium care and equipment products – giving cyclists superior vision and visibility after dark and the confidence to handle any situation. Whether it's mountain biking in low light conditions, navigating rush-hour traffic, or fixing a flat tyre on your way from work.

1

OSRAM-quality guaranteed

All OSRAM products are extensively stress tested by our quality assurance system. For information concerning guarantees, visit www.osram.com/am-guarantee or scan the QR code.



2

LEDSBIKE® lighting

Our bicycle light range includes three high-quality LED front lights, sold as a set with a rear light.



3

Care and equipment

The bicycle care and equipment portfolio includes a compact rechargeable tyre inflator and a flexible LED headband for at home and on-the-go.

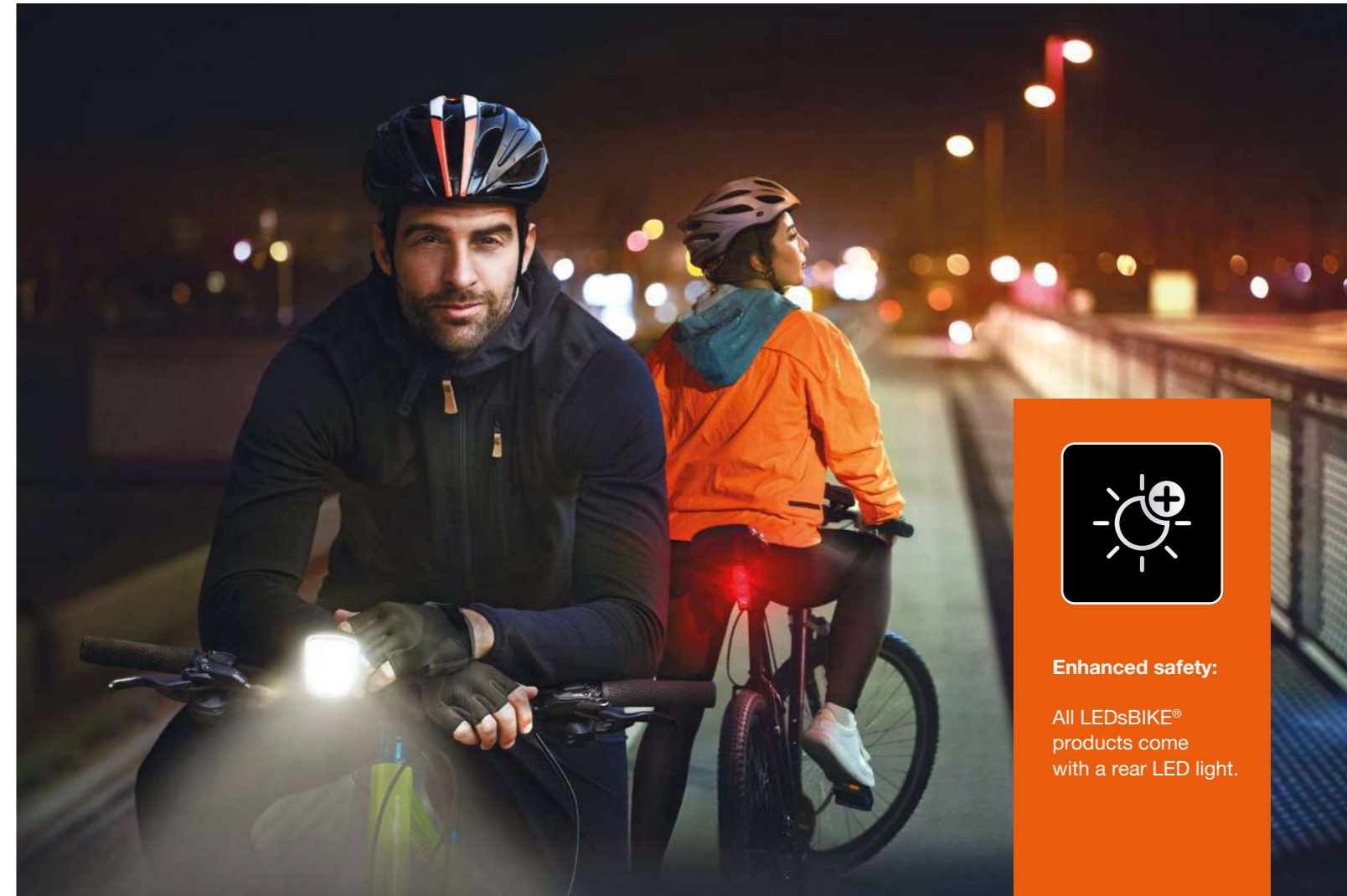

Enhanced safety:

All LEDSBIKE® products come with a rear LED light.

1 LEDSBIKE® lights

Superior vision and visibility for every ride

Whether you're a casual commuter or an avid enthusiast, high quality light is an important safety measure. LEDSBIKE® lights are equipped with a long-lasting rechargeable battery, three light settings, and the same high-performance OSRAM LED technology that we developed for cars. Their superior vision and visibility give you the confidence and freedom to keep going long after the sun goes down.



StVZO street legal:
Approved according to German StVZO with K-Mark for on-road use.



The modern side lighting:
Stands out, adding both style and improved visibility.



Weather-resistant design:
To withstand varying outdoor conditions.

¹⁾ In automotive lighting.

LEDSBIKE® RACE 50 SET



A compact, rechargeable LED front bicycle light with three brightness settings and an adjustable mounting bracket for tool-free installation.

Features

- Luminosity up to 50 Lux and up to 60 m long light beam
- Manual brightness settings: max (100%), low (50%), eco (25%)
- Usage time up to 14 hours¹⁾ (front light), 13 hours (rear light)
- Adjustable 360° bracket with rubber strap, tool-free installation on all bicycle types
- Black ABS housing and transparent polycarbonate lens

Benefits

- Weather-resistant design: protection class IP44 water-resistant
- USB-C charging, battery and charge status indicator (cable included)
- Fully approved according to German StVZO for on-road use
- Includes a rechargeable, strap-mounted LED rear light
- 2-year guarantee²⁾

LEDSBIKE® RACE 80 SET



A compact, rechargeable LED front bicycle light with three manual brightness settings, automatic mode, a function indicator, and adjustable mounting bracket.

Features

- Luminosity up to 80 Lux and up to 80 m long light beam
- Automatic and manual brightness settings with setting indicator: max (100%), low (50%), eco (25%)
- Usage time up to 13 hours³⁾ (front and rear light)
- Adjustable 360° bracket with rubber strap, tool-free installation on all bicycle types
- Black ABS housing and transparent polycarbonate lens

Benefits

- Weather-resistant design: protection class IP44 water-resistant
- USB-C charging, battery and charge status indicator (cable included)
- Fully approved according to German StVZO for on-road use
- Includes a rechargeable, strap-mounted LED rear light
- 2-year guarantee²⁾

LEDSBIKE® RACE 100 SET



Our brightest LED front bicycle light with three manual brightness settings, automatic mode, a function indicator, and adjustable mounting bracket and rear light inclusive intelligent brake light.

Features

- Luminosity up to 100 Lux and up to 100 m long light beam
- Automatic and manual brightness settings with setting indicator: max (100%), low (50%), eco (25%)
- Rear light incl. brake light
- Usage time up to 13 hours⁴⁾ (front and rear light)
- Adjustable 360° bracket with rubber strap, tool-free installation on all bicycle types
- Aluminum heat sink, black ABS housing and transparent polycarbonate lens

Benefits

- Weather-resistant design: protection class IP44 water-resistant
- USB-C charging, battery and charge status indicator (cable included)
- Fully approved according to German StVZO for on-road use
- Includes a rechargeable, strap-mounted LED rear light
- 2-year guarantee²⁾

LEDSBIKE®

range



Name	LEDSBIKE® RACE 50 SET	LEDSBIKE® RACE 80 SET	LEDSBIKE® RACE 100 SET
Product number	LEDBL101 SET	LEDBL102 SET	LEDBL103 SET
EAN	4062172403832	4062172403856	4062172403870
Voltage (V)	3.7	3.7	3.7
Lux (lx)	50	80	100
(m)@1lux	60	80	100
IP rating	44	44	44
Kelvin (K)	6300	5400	5400
Operating time on max level (h)	Up to 4 (front light)	Up to 3.5 (front light)	Up to 4 (front light)
Max operating time (h)	Up to 14 (front light) Up to 13 (rear light)	Up to 13 (front and rear light)	Up to 13 (front and rear light)
Power supply	USB-C	USB-C	USB-C
Rechargeable	Yes	Yes	Yes
Charging equipment included	Yes	Yes	Yes
Battery type	Lithium	Lithium	Lithium
StVZO	Yes	Yes	Yes
Product weight net (g)	154	154	160

1) Front light usage time varies depending on the brightness level: 25 %: 14 hours; 50 %: 7,5 hours; 100 %: 4 hours. 2) For precise conditions please refer to www.osram.com/am-guarantee. 3) Front light usage time varies depending on the brightness level: 25 %: 13 hours; 50 %: 6,5 hours; 100 %: 3,5 hours. 4) Front light usage time varies depending on the brightness level: 25 %: 13 hours; 50 %: 9 hours; 100 %: 4 hours.



2-year OSRAM guarantee:¹⁾

OSRAM products are innovative and technologically high-quality products that are carefully-tested and subject to the strict monitoring undertaken by the OSRAM quality assurance system.

2 Road-ready care and equipment

Be prepared with essential bike accessories

Whether you ride a city bike, mountain bike, trekking bike or race bike – regular maintenance and servicing makes riding safer. The OSRAM bicycle care and equipment portfolio includes a compact and portable rechargeable tyre inflator, as well as a flexible LED headband – for when you need to service on-the-go in low light conditions.



Flexible head band:
Soft padding and additional adjustable strap for optimal wearing comfort.



Fast charging:
LEDinspect® products charge up to 3x faster than standard LED inspection lamps.



Digital & Auto-Stop:
Digital backlit display and Auto-Stop function when pre-set pressure is reached.

LEDinspect® FLEXIBLE HEAD TORCH

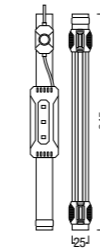

LEDIL414

This comfortable head lamp with two light levels is ideal for routine servicing and roadside repairs. It also has a flashing red rear LED warning light for added safety. The LEDinspect FLEXIBLE HEAD TORCH can also be used to enhance visibility and vision while on-the-go.

Features

- Brightness: up to 115 lm (high), 50 lm (low) and flashing
- Cool-white colour (up to 6 000 K)
- Flexible and foldable
- Rear red warning light
- Dust, water, and shock resistant
- Protection classes: IP42, IK07

Benefits

- USB Micro B charging
- Battery life: up to 5.5 h on low, 4.5 h on high
- 2-year guarantee¹⁾

TYREinflate 2000

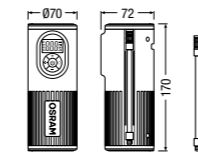

OTIR2000

This rechargeable tyre inflator is purposely designed to meet all your cycling needs. Its digital, backlit display ensures accurate pressure measurements. The TYREinflate 2000 also has an integrated LED flashlight and power bank functionality, so you can charge your cell phone in emergency situations.

Features

- Digital display with memory setting showing pressure readings in BAR, kPA and PSI
- Inflates a tyre from flat in 2 minutes²⁾
- Auto-Stop function
- Flexible 14.5 cm air hose with easy access storage
- Rechargeable via USB power cable

Benefits

- Improved reading or pressure settings with illumination in dark environments
- Complete with two-piece adapter set, bike mount and storage bag
- Stops inflating when target pressure reached
- Designed to reduce kinks, preventing unnecessary wear and tear
- 2-year guarantee¹⁾

LEDinspect®		TYREinflate	
Name	LEDinspect® FLEXIBLE HEAD TORCH	Name	TYREinflate 2000
Product number	LEDIL414	Product number	OTIR2000
EAN	4052899630994	EAN	4062172198769
No. of LED	1	Display type	Large Digital
Max lumen output (lm)	115	Inflation time	2 mins ²⁾
Min lumen output (lm)	50	Auto-Stop function	Yes
Torch lumen output (lm)	Yes	Light	Yes
Power supply	USB-C	Power supply (V)	3,7 V Li-Ion Battery
Operating time on max level (h)	Up to 4.5	Adapters	Yes
Max operating time (h)	Up to 5.5	Case	Yes

¹⁾ For precise conditions please refer to www.osram.com/am-guarantee.

¹⁾ For precise conditions please refer to www.osram.com/am-guarantee. ²⁾ Inflation time based on a bike tyre from 0 to 5.5 BAR.



Professional Automotive Care & Equipment

Workshop-approved quality



OSRAM-quality guaranteed

All OSRAM products are extensively stress tested by our quality assurance system. For information concerning guarantees, visit www.osram.com/am-guarantee or scan the QR code.

1

Inspection lights

The LEDinspect® PRO range includes a variety of handheld, wearable, and mounted LED inspection lights.



2

Battery care

With a range of BATTERYcharge PRO, BATTERYtest PRO, and BATTERYstart PRO products to choose from, all your battery needs are taken care of.



3

Power inverters

Stay powered up on the road with our pure and modified sine wave inverters.



4

Warning and safety lights

Be ready for any roadside repair with the LEDguardian® warning and safety light range.



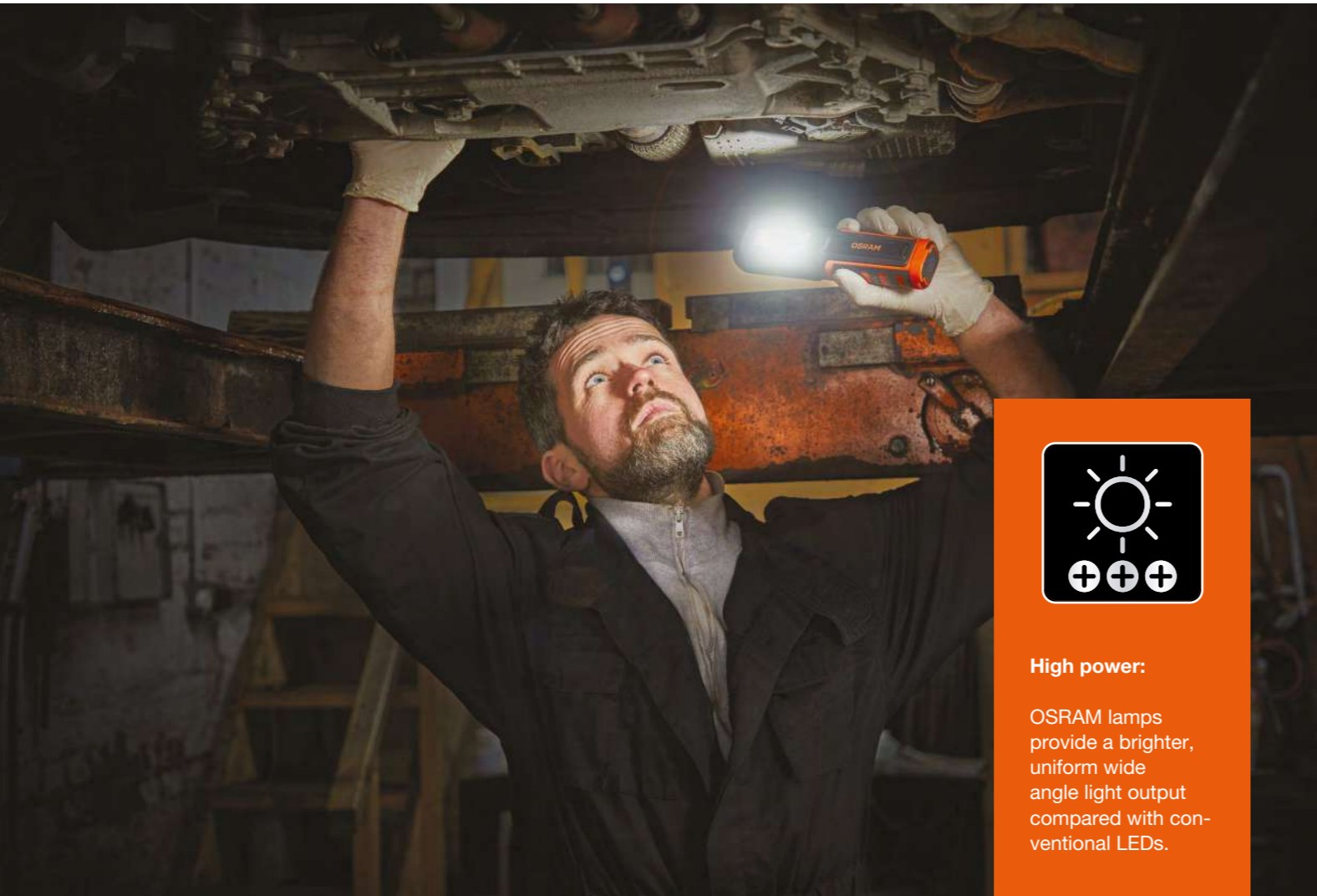

High power:

OSRAM lamps provide a brighter, uniform wide angle light output compared with conventional LEDs.

1 Inspection lights

Essential for professional work

LEDinspect® PRO inspection lights are purpose-built for repairs and routine maintenance in workshops and service centers. Available in a variety of sizes and styles, from handheld and wearable to magnetic and hook-mounted lights, the range offers innovative solutions for every application. High-performance, long-lasting LEDs produce powerful cool-white light. And our ergonomic designs ensure light is delivered precisely where it's needed, illuminating the darkest corners and hard-to-reach areas.



Shock resistant:

IK09 is the maximum classification for protection provided by enclosures for electrical equipment against external impacts.



Multi-Positioning:

Allows you to easily direct light output exactly where you need it.



Hands-free:

Position light perfectly and easily using magnets, clips and hooks.

LEDinspect® WIRE-FREE PRO 600

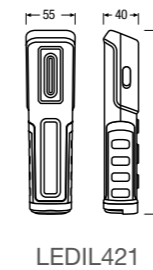

LEDIL421

A bright inspection light with the possibility to simplify recharging via a magnetic charging pad.

Features

- Brightness: up to 600 lm (high), 100 lm (torch)
- Cool-white colour (up to 5 700 K)
- Multi-angle positioning: 180° flex
- Magnetic base, back and hanging hook
- Dust, water, and shock resistant
- Protection classes: IP65, IK08

Benefits

- Battery charge status indicator, USB-C cable included
- Battery life: up to 10 h on torch, 3 h on high, 2 h charging time
- Magnetic "Wire-Free" charging via charging pad
- 2-year guarantee¹⁾

LEDinspect® WIRE-FREE SLIM 600

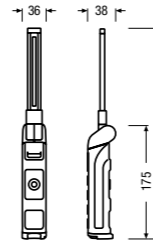

LEDIL422

A bright inspection light with the possibility to simplify recharging via a magnetic charging pad.

Features

- Brightness: up to 600 lm (high), 100 lm (torch)
- Cool-white colour (up to 5 700 K)
- Multi-angle positioning: 180° flex and 270° twist
- Magnetic base, back and hanging hook
- Dust, water, and shock resistant
- Protection classes: IP65, IK08

Benefits

- Battery charge status indicator, USB-C cable included
- Battery life: up to 10 h on torch, 3 h on high, 2 h charging time
- Magnetic "Wire-Free" charging via charging pad
- 2-year guarantee¹⁾

LEDinspect® SINGLE CHARGE PAD

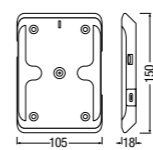

LEDIL423

A magnetic charging pad with one charge point to effortlessly charge one individual inspection light.

Features

- Wire-Free charging capability
- "Daisy Chain" function
- Different mounting options
- Powerful magnets
- One charging point to charge one product on a single base

Benefits

- Positive direct wire-free connection for charging
- Can link to another pad (single or duo) to charge more lamps
- Can attach to a wall or metal surface
- Can easily support inspection lamp on metal surface
- 2-year guarantee¹⁾

LEDinspect® DUAL CHARGE PAD

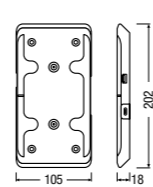

LEDIL424

A magnetic charging pad with two charge points to effortlessly charge two individual inspection lights.

Features

- Wire-Free charging capability
- "Daisy Chain" function
- Different mounting options
- Powerful magnets
- Two charging points to charge two products on a single base

Benefits

- Positive direct wire-free connection for charging
- Can link to another pad (single or duo) to charge more lamps
- Can attach to a wall or metal surface
- Can easily support inspection lamp on metal surface
- 2-year guarantee¹⁾

¹⁾ For precise conditions please refer to www.osram.com/am-guarantee.

LEDinspect® SLIM MAX 1000

This versatile, rechargeable work light with an integrated dimmer allows you to adjust the brightness level to your liking.

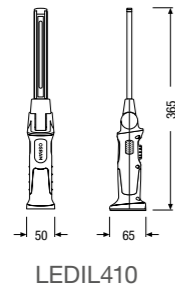

LEDIL410

Features

- Brightness: up to 1000 lm (high), 100 lm (low), 100 lm (torch)
- Cool-white colour (up to 6 000 K)
- Multi-angle positioning: 120° flexibility
- Magnetic base, back and hanging hook
- Dust, water, and shock resistant
- Protection classes: IP65, IK06

Benefits

- USB-C charging and charge status indicator
- Battery life: up to 10.5 h on low, 1.5 h on high
- 2-year guarantee¹⁾

LEDinspect® SLIM 500

An ultra-flat, rechargeable folding light with three settings (high, low, and flashlight) and a non-slip, dirt-repellent surface.

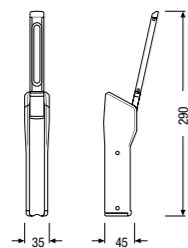

LEDIL403

Features

- Brightness: up to 500 lm (high), 250 lm (low), 70 lm (torch)
- Cool-white colour (up to 6 000 K)
- Multi-angle positioning: 180° flex and 270° twist
- Magnetic base and hanging hook
- Dust, water, and shock resistant
- Protection classes: IP54, IK07

Benefits

- USB-C charging and charge status indicator
- Battery life: up to 6 h on low, 3.5 h on high
- 2-year guarantee¹⁾

LEDinspect® POCKET 200

A slim and lightweight rechargeable light with foldable design for working in confined and hard-to-reach spaces.

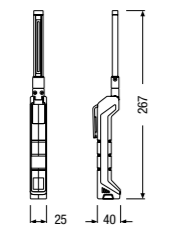

LEDIL408

Features

- Brightness: up to 200 lm (high), 80 lm (low), 40 lm (torch)
- Cool-white colour (up to 6 500 K)
- Multi-angle positioning: 180° flex and 360° twist
- Magnetic base
- Dust, water, and shock resistant
- Protection classes: IP20, IK07

Benefits

- USB-C charging and charge status indicator
- Battery life: up to 3 h on low, 1.5 h on high
- 2-year guarantee¹⁾

LEDinspect® MAX 500

A rechargeable light with two standard LED light settings as well as a UV torchlight setting for leak detection.

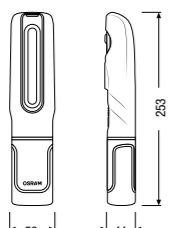

LEDIL402

Features

- Brightness: up to 500 lm (high), 250 lm (low)
- Cool-white colour (up to 6 000 K)
- Multi-angle positioning: 180° flex and 360° twist
- Magnetic base and hanging hook
- Dust, water, and shock resistant
- Protection classes: IP65, IK08

Benefits

- USB-C charging and charge status indicator
- Battery life: up to 7.5 h on low, 4.5 h on high
- UV-light function (1 LED + 1 UV LED)
- 2-year guarantee¹⁾

LEDinspect® MINI 250

A rechargeable light with three settings (high, low, and flashlight) and a non-slip, dirt-repellent surface.

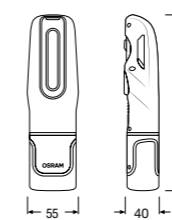

LEDIL401

Features

- Brightness: up to 250 lm (high), 130 lm (low), 70 lm (torch)
- Cool-white colour (up to 6 000 K)
- Multi-angle positioning: 180° flex
- Magnetic base and hanging hook
- Dust, water, and shock resistant
- Protection classes: IP65, IK06

Benefits

- USB-C charging and charge status indicator
- Battery life: up to 6 h on low, 3 h on high
- 2-year guarantee¹⁾

LEDinspect® TWIST 250

A lightweight and robust light with three output levels and twist function for full control over the direction of the light beam.

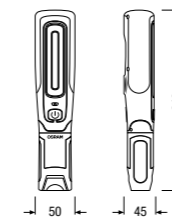

LEDIL412

Features

- Brightness: up to 250 lm (high), 125 lm (low), 80 lm (torch)
- Cool-white colour (up to 6 000 K)
- Multi-angle positioning: 120° flex and 360° twist
- Magnetic base, back and hanging hook
- Dust, water, and shock resistant
- Protection classes: IP20, IK09

Benefits

- Charging plug and cable included
- Battery life: up to 4 h on low, 3 h on high
- 2-year guarantee¹⁾

LEDinspect® UTILITY 1000

A multi-functional inspection light with varying output levels suitable for handheld, flood light, or underbonnet applications.

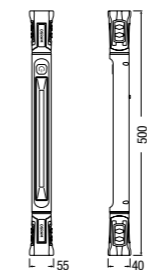

LEDIL407

Features

- Brightness: up to 1000 lm (high), 400 lm (low)
- Cool-white colour (up to 6 500 K)
- Multi-angle positioning: 180° flex and 360° twist
- Magnetic base, back and hanging hook
- Dust, water, and shock resistant
- Protection classes: IP20, IK07

Benefits

- 2 x charging plugs and charge status indicator
- Battery life: up to 5.5 h on low, 2.5 h on high
- 2-year guarantee¹⁾

LEDinspect® RECHARGEABLE UNDERBONNET LIGHT

An engine compartment light with rotating light bar, extendable mounting rod with soft padded feet, and lightweight design to avoid damage to vehicles.

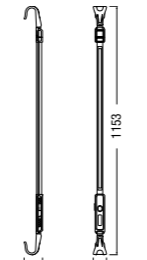

LEDIL415

Features

- Brightness: up to 1200 lm (high), 600 lm (low)
- Cool-white colour (up to 6 500 K)
- Multi-angle positioning: 360° lightbar rotation
- Extendable up to 1.8 m
- Dust, water, and shock resistant
- Protection classes: IP65, IK07

Benefits

- USB-C charging and charge status indicator
- Battery life: up to 4.5 h on low, 2 h on high
- 2-year guarantee¹⁾

¹⁾ For precise conditions please refer to www.osram.com/am-guarantee.

¹⁾ For precise conditions please refer to www.osram.com/am-guarantee.

LEDinspect® FLEXIBLE INSPECTION LIGHT

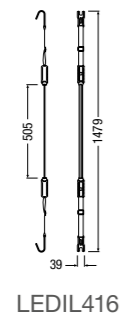

LEDIL416

A versatile inspection light, directing the light where needed. The light strip is fully flexible, allowing the light to bend around the workspace.

Features

- Brightness: up to 1000 lm (high), 400 lm (low) plus a red light option
- Multi-angle positioning: 160° twist
- Removable elasticated straps with hooks – extendable length up to 2.1 m
- Magnets offer more fixing options
- Dust, water, and shock resistant
- Protection classes: IP52, IK07

Benefits

- USB-C cable included
- Battery life: up to 20 h on low, 6.5 h on medium, 3 h high
- Flexible design
- 2-year guarantee¹⁾

LEDinspect® HEADTORCH 250

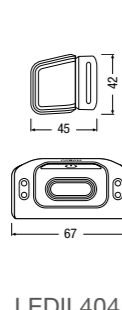

LEDIL404

A high-quality head lamp with two output levels, motion sensor, and adjustable strap with soft padding for optimal comfort.

Features

- Brightness: up to 250 lm (high), 140 lm (low)
- Cool-white colour (up to 5 700 K)
- Multi-angle positioning: 60° flex
- Dust, water, and shock resistant
- Protection classes: IP54, IK08

Benefits

- USB-C charging
- Battery life: up to 6 h on low, 3.5 h on high
- Integrated motion sensor technology
- 2-year guarantee¹⁾

LEDinspect® WEARABLE NECK LIGHT

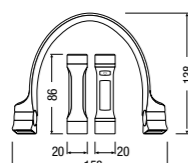

LEDIL413

A rechargeable neck light with two detachable torches, two light settings, and built-in magnet allows for convenient hands-free working.

Features

- Brightness: up to 265 lm (high), 130 lm (low)
- Cool-white colour (up to 6 500 K)
- Multi-angle positioning: 90° flex
- Built-in magnet for off-person mounting
- Dust, water, and shock resistant
- Protection classes: IP54, IK07

Benefits

- 2 x USB Micro B charging ports
- Battery life: up to 4.5 h on low, 3 h on high
- Separately powered torches with power button on each
- 2-year guarantee¹⁾

LEDinspect® FLEXIBLE HEAD TORCH

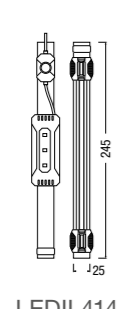

LEDIL414

A head lamp with two light levels, flashing red rear LED warning light for safety and flexible, foldable design for easy storage and transport.

Features

- Brightness: up to 115 lm (high), 50 lm (low) and flashing
- Cool-white colour (up to 6 000 K)
- Flexible and foldable
- Rear red warning light
- Dust, water, and shock resistant
- Protection classes: IP42, IK07

Benefits

- USB Micro B charging
- Battery life: up to 5.5 h on low, 4.5 h on high
- 2-year guarantee¹⁾

LEDinspect®

range



Name	LEDinspect® WIRE-FREE PRO 600	LEDinspect® WIRE-FREE SLIM 600	LEDinspect® SINGLE CHARGE PAD	LEDinspect® DUAL CHARGE PAD
Product number	LEDIL421	LEDIL422	LEDIL423	LEDIL424
EAN	4062172393126	4062172393140	4062172393164	4062172393188
No. of LED	1+1	1+1	N/A	N/A
Max lumen output (lm)	600	600	N/A	N/A
Min lumen output (lm)	N/A	N/A	N/A	N/A
Torch lumen output (lm)	100	100	N/A	N/A
Power supply	Magnetic Charge Pad, USB-C	Magnetic Charge Pad, USB-C	Magnetic Charge Pad, USB-C	Magnetic Charge Pad, USB-C
Operating time on max level (h)	Up to 3	Up to 3	N/A	N/A
Max operating time (h)	Up to 10	Up to 10	N/A	N/A
Charging time (h)	ca. 2.5	ok. 2.5	N/A	N/A
Dimming	No	No	N/A	N/A
IP rating	65	65	20	20
IK rating	08	08	08	08
Foldable	No	Yes	N/A	N/A
Adjustability	180° flex	180° flex 270° twist	N/A	N/A
Rechargeable	Yes	Yes	No	No
Charging equipment included	Lead	Lead	Lead	Lead
Product weight (g)	300	240	190	270
Battery type	Lithium	Lithium	N/A	N/A
Kelvin (K)	5700	5700	N/A	N/A

¹⁾ For precise conditions please refer to www.osram.com/am-guarantee.

LEDinspect® range												
Name	LEDinspect® SLIM MAX 1000	LEDinspect® SLIM 500	LEDinspect® POCKET 200	LEDinspect® MAX 500	LEDinspect® MINI 250	LEDinspect® TWIST 250	LEDinspect® UTILITY 1000	LEDinspect® RECHARGEABLE UNDERBONNET LIGHT	LEDinspect® FLEXIBLE INSPECTION LIGHT	LEDinspect® HEADTORCH 250	LEDinspect® WEARABLE NECK LIGHT	LEDinspect® FLEXIBLE HEAD TORCH
Product number	LEDIL410	LEDIL403	LEDIL408	LEDIL402	LEDIL401	LEDIL412	LEDIL407	LEDIL415	LEDIL416	LEDIL404	LEDIL413	LEDIL414
EAN	4062172355674	4052899623842	4052899623897	4052899623835	4052899623828	4052899623934	4062172338356	4052899631021	4062172405959	4062172354875	4052899630987	4052899630994
No. of LED	1+1	1+1	1+1	1+1 UV	1+1	1+1	1	32	1	1	1+1	1
Max lumen output (lm)	1000	500	200	500	250	250	1000	1200	1000	250	265	115
Min lumen output (lm)	100	250	80	250	130	125	400	600	100	140	130	50
Torch lumen output (lm)	100	70	40	N/A	70	80	N/A	N/A	N/A	N/A	Yes	Yes
Power supply	USB-C	USB-C	USB-C	USB-C	USB-C	DC Barrel Jack	USB-C	USB-C	USB-C	USB-C	USB Micro B	USB-C
Operating time on max level (h)	Up to 1.5	Up to 3.5	Up to 1.5	Up to 4.5	Up to 3	Up to 3	Up to 2.5	Up to 2	Up to 3	Up to 3.5	Up to 3	Up to 4.5
Max operating time (h)	Up to 10.5	Up to 6	Up to 3	Up to 7.5	Up to 6	Up to 4	Up to 5.5	Up to 4.5	Up to 20	Up to 6	Up to 4.5	Up to 5.5
Charging time (h)	ca. 3.5	ca. 3.5	ca. 2	ca. 5.5	ca. 3.5	ca. 4.5	ca. 5	ca. 3	ca. 7	ca. 3.5	ca. 1.5	ca. 1.5
Dimming	Yes	No	No	No	No	No	No	No	No	No	No	No
IP rating	65	54	20	65	65	20	20	65	52	54	54	42
IK rating	06	07	07	08	07	09	07	07	07	08	07	N/A
Foldable	No	Yes	Yes	No	No	No	No	No	Flexible	No	Yes	No
Adjustability	120° flex	180° flex 270° twist	180° flex 360° twist	180° flex 360° twist	180° flex	120° flex 360° twist	180° flex 360° twist	360° twist	160° twist on each handle	60° flex	90° flex	N/A
Rechargeable	Yes	Yes	Yes	Yes	Yes	Yes	Yes	Yes	Yes	Yes	Yes	Yes
Charging equipment included	No	Yes	Cable included	Yes	Yes	Yes	Yes	Yes	Yes	Yes	Yes	Yes
Product weight (g)	308	155	120	350	215	488	588	840	259	105	115	62
Battery type	Lithium	Lithium	Lithium	Lithium	Lithium	Lithium	Lithium	Lithium	Lithium	Lithium	Lithium	Lithium
Kelvin (K)	6000	6000	6500	6000	6000	6000	6500	6500	6200-6500	5700	6500	6000

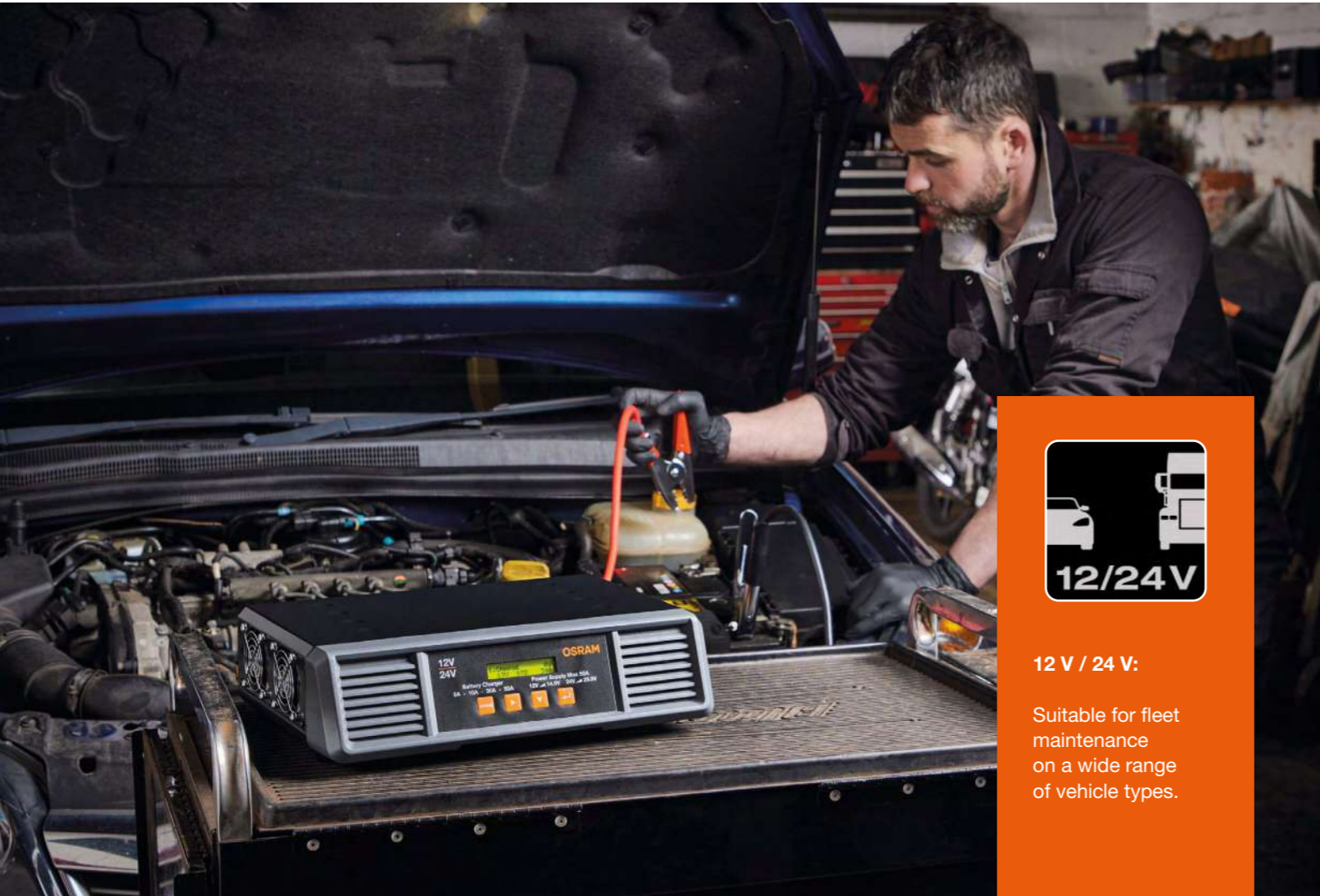

12 V / 24 V:

Suitable for fleet maintenance on a wide range of vehicle types.

2 Battery care

Quality chargers, testers, and starters

Battery testing and charging are a core part of any automotive workshop's service offering. Given the advanced electronic systems in modern cars, you need high-quality chargers and sophisticated diagnostic equipment that you can rely on. Our BATTERYcharge PRO, BATTERYtest PRO, and BATTERYstart PRO products cover a wide range of battery care and maintenance applications, for both 12 V and 24 V vehicles.



Rapid recharge:
A battery charging mode that reaches full charge in a few minutes.



Workshop-approved:
Specially developed to withstand demanding day-to-day work.



Versatile:
Suitable for a wide range of battery types, including lithium, as well as for batteries in electric and hybrid vehicles.

BATTERYcharge PRO

Made by professionals – for professionals

All BATTERYcharge PRO products are designed for intensive, long-term use in workshops and professional settings.

Suitable for 12 V and 24 V vehicles such as motorbikes, cars, vans, and trucks, they adapt to versatile requirements. Ideal for maintaining various vehicles or fleets in professional workshops. Depending on the model, products provide varying charging currents, up to 100 A.

They are suitable for lead-acid and lithium batteries, as well as batteries in vehicles with Start/Stop systems. Additionally, an integrated testing function allows for battery and alternator diagnosis.



BATTERYstart PRO

Your Go-To Emergency Solution

Our BATTERYstart PRO 1000 is lightweight and portable and offers fast jump-starting for various vehicles, including all gasoline engines and diesel engines up to 10 l. The rapid charging feature allows recharging via a PD60W charger or USB Type-C connector. Safety is paramount with built-in protocols that protect against reverse polarity, over-voltage, under-voltage, and excessive temperature.

The BATTERYstart PRO 1000 retains its charge over extended periods and can be conveniently charged in the vehicle. It includes emergency lighting with warning lights and an SOS signal.

BATTERYtest PRO

Electrical fault detection made easy

Electrical systems on vehicles have become ever more sophisticated. OSRAM's BATTERYtest PRO 600 is a multi-function automotive tester and designed specifically for finding electrical vehicle faults. Compatible with 6 V, 12 V, 24 V vehicles and up to 50 V specialist vehicles, this professional workshop tool can help mechanics find electrical faults quickly and run a more efficient garage.

This multi-function unit will test and find faults with voltage, starter test and alternator start processes. It will also run frequency and duty cycles for the testing of sensors and continuity and resistance modes for locating wiring faults.



BATTERYcharge PRO 30 A

A lightweight charger suitable for repairs and maintenance on 12 V and 24 V vehicles.



Features

- Battery support power supply function: 12-14.9 V @ 30 A and 24-28.9 V @ 30 A (incl. lead-acid, lithium, and Start/Stop batteries)
- Adjustable charging rate (5/10/20/30 A)
- Charge cycle: 7-stage (lithium), 9-stage (Lead Acid/Gel/AGM/Calcium/EFB)

Benefits

- Rapid recharge in minutes
- Pre-charge health test and battery and alternator diagnosis
- Slimline design with large LCD display, fixed clamps and power cord
- 2-year guarantee¹⁾

OSCP3024

BATTERYcharge PRO 50 A

A versatile and compact charger suitable for repairs and maintenance on 12 V and 24 V vehicles.



Features

- Battery support power supply function: 12-14.9 V 50 A and 24-28.9 V @ 50 A (incl. lead-acid, lithium, and Start/Stop batteries)
- Adjustable charging rate (5/10/30/50 A)
- Charge cycle: 7-stage (lithium), 9-stage (Lead Acid/Gel/AGM/Calcium/EFB)

Benefits

- Rapid recharge in minutes
- Pre-charge health test and battery and alternator diagnosis
- Large LCD display screen, removable insulated clamps
- 2-year guarantee¹⁾

OSCP5024

BATTERYcharge PRO 60 A

A high-performance charger with jump start function to revive flat batteries (540 A @ 12 V; 270 A @ 24 V), and handle and wheels for convenient portability.



Features

- Variable charging currents (up to 60 A at 12 V and 30 A at 24 V)
- Adjustable charging rate (5/20/60 A for 12 V; 5/20/30 A for 24 V)
- Charge cycle: 7-stage (lithium), 9-stage (Lead Acid/Gel/AGM/Calcium/EFB)
- Suitable for lead-acid, lithium, and Start/Stop batteries

Benefits

- Rapid recharge in minutes
- Pre-charge health test and battery and alternator diagnosis
- Large LCD display screen, removable insulated clamps
- 2-year guarantee¹⁾

OSCP60T

BATTERYcharge PRO 100 A

A high-performance charger that is easy to transport and suitable for all types of 12 V and 24 V batteries.



Features

- Battery support power supply function: 12-14.9 V 100 A and 24-28.9 V @ 100 A (incl. lead-acid, lithium, and Start/Stop batteries)
- Adjustable charging rate (5/10/30/50/60/100 A for 12 V & 24 V)
- Charge cycle: 7-stage (lithium), 9-stage (Lead Acid/Gel/AGM/Calcium/EFB batteries)

Benefits

- Rapid recharge in minutes
- Pre-charge health test and battery and alternator diagnosis
- Large LCD display screen, removable insulated clamps
- 2-year guarantee¹⁾

OSCP10024

¹⁾ For precise conditions please refer to www.osram.com/am-guarantee.

BATTERYtest PRO 600

A 3-in-1 automotive tester with multimeter, battery analyser and fuse test capability.



Features

- Multi-functional: battery, cranking and alternator testing
- Voltage, current, continuity and frequency testing
- Fuse testing using multi-function probes (supplied with the unit)
- Suitable for 12 V and 24 V vehicles

Benefits

- The supplied 1.2 m and 1.8 m test leads (3 m total) allow for testing from vehicle cab
- LED work light, hanging hook and stand
- Storage case
- 2-year guarantee¹⁾

OMM600

BATTERYstart PRO 1000

A compact and lightweight lithium jump starter for a wide range of vehicles.



Features

- 1 000 A start current, 1 500 A peak current
- Built-in safety protocols (reverse polarity, battery over voltage, battery under voltage, under temperature)
- Suitable for 12 V vehicles with any-size petrol engines and up to 10 l diesel engines

Benefits

- Rapid recharging via PD60W charger or standard charging via USB-C
- Powerful LED light with SOS and warning modes
- 2-year guarantee¹⁾

OEBSPL1000

¹⁾ For precise conditions please refer to www.osram.com/am-guarantee.

BATTERYcharge PRO

range



Name	BATTERYcharge PRO 30A	BATTERYcharge PRO 50A	BATTERYcharge PRO 60A	BATTERYcharge PRO 100A
Product number	OSCP3024	OSCP5024	OSCP60T	OSCP10024
EAN	4052899629073	4052899629080	4052899629141	4052899629103
Weight (g)	2800	6500	18500	6900
Wattage (W)	980	1500	1200	3000
Voltage (V)	12/24	12/24	12/24	12/24
Variable charging rates (A)	5/10/20/30	5/10/30/50	5/20/60 ¹⁾	5/10/30/50/60/100 ⁴⁾ 5/10/30/50/60/80 ⁵⁾
Continuous charge (up to) (A)	30	50	60 ²⁾ /30 ³⁾	100
Max. battery capacity (Ah)	300	500	700	1000
Min. battery capacity (Ah)	14	14	14	14
Recommended to use with	Motorcycle, Car, 4x4, Commercial Vehicle, Boat	Motorcycle, Car, 4x4, Commercial Vehicle, Boat	Motorcycle, Car, 4x4, Commercial Vehicle, Boat	Motorcycle, Car, 4x4, Commercial Vehicle, Boat
Auto-stop function	Yes	Yes	Yes	Yes
Stages: Lithium	8	7	7	7
Stages: Lead acid/Gel/AGM/Calcium/EFB	9	9	3	9

1) Variable charging rates at 24 V. 2) Continuous charge at 12 V. 3) Continuous charge at 24 V. 4) Variable charging rates at 12/24 V. 5) Variable charging rates at 12 V.

BATTERYtest PRO



Name	BATTERYtest PRO 600
Product number	OMM600
EAN	4052899631489
Test voltage (V)	6/12/24
Voltage range (V)	±2% DC 0 - 50
Current (parallel)	0-80 A ±3%, 3 A-30 A (Mini fuse), 3 A-40 A (Standard ATC fuse), 20 A-80 A (Maxi fuse)
Current (in-line)	1-999 mA ±1% (Low range), 1-30 A ±2% (High range)
Resistance (Ω)	0-1 M ±2%
Frequency (Hz)	1 Hz – 20 kHz ±1 Hz
Continuity (Ω)	0-500
LED test	Input Volts: 3.5 V (Max.)
Clamps cable length (m)	3 (total)
Operating temperature (°C)	0-50
Battery type	3 x AAA (not included)
Battery connection	Crocodile Clamps
Recommended to use with	Motorcycle, Car, Truck, Van, Boat
Duty cycle	(Peak to Peak Volts @2.8 V ~ 15.0 V Max) 1 Hz to 1 KHz ±1%, 1 KHz to 10 KHz ±2%, 10 KHz to 20 KHz ±5%

BATTERYstart PRO



Name	BATTERYstart PRO 1000
Product number	OEBSP1000
EAN	4052899630918
12 V Power socket connection	Yes
USB sockets (2.1 A)	2
Recommended Petrol Engine size (up to)	All litres
Recommended Diesel Engine size (up to)	10 litres
Efficiency	Professional
Cranking amps (A)	1000
Peak amps (A)	1500
Charging type	USB-C
Battery type	LiCo ₂
Battery capacity (Wh)	118.4
Charging time (h)	PD60 W ~1.5 USB ~4
Power bank function	Yes



230 V AC:
OSRAM power inverters provide the standard mains connection for powering tools and equipment.

3 Power inverters

For all your off-grid needs

Roadside repairs and call outs are a regular occurrence. With a high-quality OSRAM power inverter on hand, you're always fully equipped to get the job done. Specially developed for automotive field work, our POWERinvert PRO range provides reliable 230 V AC power connection to power drills, laptops, and other essential electrical equipment. The range includes pure and modified sine wave inverters for 12 V and 24 V batteries, with power levels ranging from 600 W to 2 000 W.



Safety:
All OSRAM power inverters are equipped with a residual-current device to protect against electric shock.



Low battery alarm:
Alerts operators when the vehicle battery is running low on charge.



Quality guaranteed:
All OSRAM inverters have a minimum guarantee period of 2-years.¹⁾

¹⁾ For precise conditions please refer to www.osram.com/am-guarantee.

POWERinvert PRO Pure sine wave inverter 12 V DC 600 W RCD

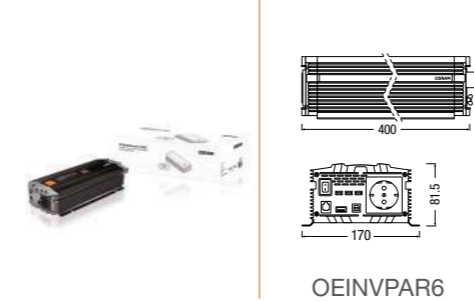

OEINVPAR6

A heavy-duty 600 W power inverter with adjustable voltage output, suitable for most passenger vehicles and select campervans.

Features

- 600 W pure sine wave inverter for 12 V vehicles
- Converts into 230-volt AC mains power
- Surge power rating (up to 200 ms) 1 200 W
- Efficiency at 75% load: 90%

Benefits

- Adjustable output: 200/220/230/240 V +/- 10%
- Overload, overheating, and low/high voltage protection
- Up to 12 hours continuous use
- 2-year guarantee¹⁾

POWERinvert PRO Pure sine wave inverter 12 V DC 1000 W RCD

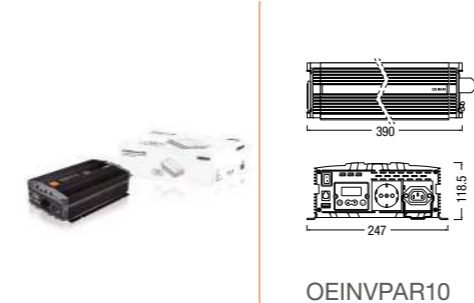

OEINVPAR10

A heavy-duty 1 000 W power inverter with adjustable voltage output, suitable for most passenger vehicles and select campervans.

Features

- 1 000 W pure sine wave inverter for 12 V vehicles
- Converts into 230-volt AC mains power
- Surge power rating (up to 200 ms) 2 000 W
- Efficiency at 75% load: 90%

Benefits

- Adjustable output: 200/220/230/240 V +/- 10%
- Overload, overheating, and low/high voltage protection
- Up to 12 hours continuous use
- 2-year guarantee¹⁾

POWERinvert PRO Pure sine wave inverter 12 V DC 2000 W RCD



OEINVPAR20

A heavy-duty 2 000 W power inverter with adjustable voltage output, suitable for most passenger vehicles and select campervans.

Features

- 2 000 W pure sine wave inverter for 12 V vehicles
- Converts into 230-volt AC mains power
- Surge power rating (up to 200 ms) 4 000 W
- Efficiency at 75% load: 90%

Benefits

- Adjustable output: 200/220/230/240 V +/- 10%
- Overload, overheating, and low/high voltage protection
- Up to 12 hours continuous use
- 2-year guarantee¹⁾

POWERinvert PRO Modified sine wave inverter 12 V DC 1000 W

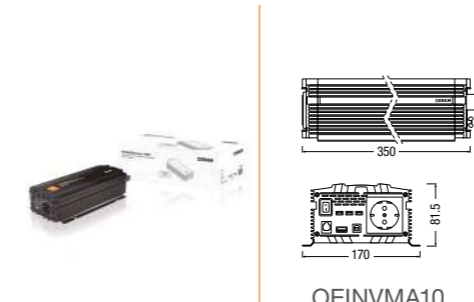

OEINVMA10

High-quality 1 000 W modified inverter with adjustable voltage output, for powering simple electronic devices and tools.

Features

- 1 000 W modified sine wave inverter for 12 V vehicles
- Converts into 230-volt AC mains power
- Surge power rating (up to 200 ms) 2 000 W
- Efficiency at 75% load: 89%

Benefits

- Adjustable output: 230 V AC +/- 10%
- Overload, overheating, and low/high voltage protection
- Up to 12 hours continuous use
- 2-year guarantee¹⁾

¹⁾ For precise conditions please refer to www.osram.com/am-guarantee.

POWERinvert PRO Modified sine wave inverter 12 V DC 2000 W

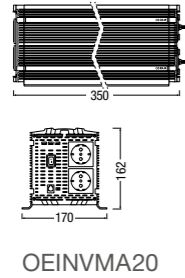

OEINVMA20

A high-quality 2 000 W modified inverter with adjustable voltage output, for powering simple electronic devices and tools.

Features

- 2 000 W modified sine wave inverter for 12 V vehicles
- Converts into 230-volt AC mains power
- Surge power rating (up to 200 ms) 4 000 W
- Efficiency at 75% load: 89%

Benefits

- Adjustable output: 230 V AC +/- 10%
- Overload, overheating, and low/high voltage protection
- Up to 12 hours continuous use
- 2-year guarantee¹⁾

POWERinvert PRO Pure sine wave inverter 24 V DC 2000 W

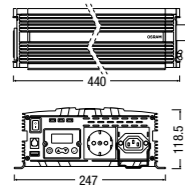

OEINVPB20

A heavy-duty 2 000 W power inverter with adjustable voltage output, suitable for 24 V vehicles.

Features

- 2 000 W pure sine wave inverter for 24 V vehicles
- Converts into 230-volt AC mains power
- Surge power rating (up to 200 ms) 2 000 W
- Efficiency at 75% load: 90%

Benefits

- Adjustable output: 200/220/230/240 V +/- 10%
- Overload, overheating, and low/high voltage protection
- Up to 12 hours continuous use
- 2-year guarantee¹⁾

POWERinvert PRO Modified sine wave inverter 24 V DC 1000 W

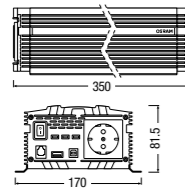

OEINVMB10

A high-quality 1 000 W modified inverter with adjustable voltage output, for powering simple electronic devices and tools.

Features

- 1 000 W modified sine wave inverter for 24 V vehicles
- Converts into 230-volt AC mains power
- Surge power rating (up to 200 ms) 2 000 W
- Efficiency at 75% load: 89%

Benefits

- Adjustable output: 230 V AC +/- 10%
- Overload, overheating, and low/high voltage protection
- Up to 12 hours continuous use
- 2-year guarantee¹⁾

LCD remote screen

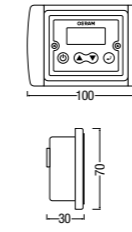

OINVLCD
EAN: 4052899631113

An auxiliary display screen for OSRAM POWERinvert PRO inverters with 6 m cable allows for easy access to readings when the inverter is fixed out of sight.

Features

- Multi-function LCD display and mounting kit (screen, frame, cable)
- Complete with fixing screws and endcaps
- Suitable for: OEINVPAR6 / OEINVMA10 / OEINVMA20

Benefits

- Complete with 6-meter cable
- 2-year guarantee¹⁾

LCD frame

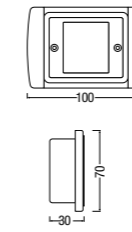

OINVFRM
EAN: 4052899631120

A protective frame that allows for fixed remote installation of the inverter's LCD screen.

Features

- Frame for mounting existing screen remotely
- Complete with fixing screws and endcaps
- Suitable for: OEINVPAR10 / OEINVPAR20

Benefits

- Complete with 6-meter cable
- 2-year guarantee¹⁾

¹⁾ For precise conditions please refer to www.osram.com/am-guarantee.

¹⁾ For precise conditions please refer to www.osram.com/am-guarantee.

POWERinvert PRO

range



Name	POWERinvert PRO Pure sine 600 W RCD	POWERinvert PRO Pure sine 1000 W RCD	POWERinvert PRO Pure sine 2000 W RCD	POWERinvert PRO Modified 1000 W	POWERinvert PRO Modified 2000 W	POWERinvert PRO Pure sine wave inverter 24 V DC 2000 W	POWERinvert PRO Modified sine wave inverter 24 V DC 1000 W
Product number	OEINVPAR6	OEINVPAR10	OEINVPAR20	OEINVMA10	OEINVMA20	OEINVPB20	OEINVMB10
EAN	4052899631045	4052899631052	4052899631069	4052899631076	4052899631083	4052899631090	4052899631106
Voltage (V)	12	12	12	12	12	24	24
Cont. power rating (up to 12 hrs) (W)	600	1000	2000	1000	2000	2000	1000
Peak power rating (up to 200 ms) (V)	1200	2000	4000	2000	4000	4000	2000
Output voltage (V)	200/220/230/240 AC ± 10%	200/220/230/240 AC ± 10%	200/220/230/240 AC ± 10%	230 AC ± 10%	230 AC ± 10%	200/220/230/240 AC ± 10%	230 AC ± 10%
Output frequency (Hz)	50/60	50/60	50/60	50	50	50/60	50
Output waveform	Pure sine wave	Pure sine wave	Pure sine wave	Modified sine wave	Modified sine wave	Pure sine wave	Modified sine wave
Input voltage range (V)	9.5-16.5 (12 V nom)	9.5-16.5 (12 V nom)	9.5-16.5 (12 V nom)	10.0-16.0 (12 V nom)	10.0-16.0 (12 V nom)	19.0 V-33.0 V (24 V nom)	20.0 V-32.0 V (24 V nom)
Max input current (A)	59	98	196	98	196	98	49
Efficiency @75% load	90%	90%	90%	89%	89%	90%	89%
No load current (A)	<1.5	<1.6	<2.0	<0.7	<0.8	<1.5	<0.45
Power saving mode	Yes	Yes	Yes	No	No	Yes	No
Power saving current (A)	>0.2	>0.2	>0.2	x	x	>0.2	x
Low battery alarm (V)	10.0-11.5 ± 0.5	10.0-11.5 ± 0.5	10.0-11.5 ± 0.5	10.5 ± 0.5	10.5 ± 0.5	20.0-23.0 ± 0.5	21.0 ± 0.5
Low battery shutdown (V)	9.5-11.0 ± 0.5	9.5-11.0 ± 0.5	9.5-11.0 ± 0.5	10.0 ± 0.5	10.0 ± 0.5	19.0-22.0 ± 0.5	20.0 ± 0.5
Thermal protection (Celsius)	60 ± 10°	60 ± 10°	60 ± 10°	60 ± 10°	60 ± 10°	60 ± 10°	60 ± 10°
LCD screen	No ¹⁾	Yes ²⁾	Yes ²⁾	No ¹⁾	No ¹⁾	Yes ²⁾	No ¹⁾
Built in RCD	Yes	Yes	Yes	No	No	No	No
USB port (A)	2.1	2.1	2.1	2.1	2.1	2.1	2.1
Display port panel	Yes	Yes	Yes	Yes	Yes	Yes	Yes
Current sensor port	Yes	Yes	Yes	Yes	Yes	Yes	Yes
Comms port	Yes	Yes	Yes	No	No	Yes	No

1) LCD remote screen OINVLCD separately available. 2) Mount existing screen remotely with frame OINVFRM.

1) LCD remote screen OINVLCD separately available. 2) Mount existing screen remotely with frame OINVFRM.

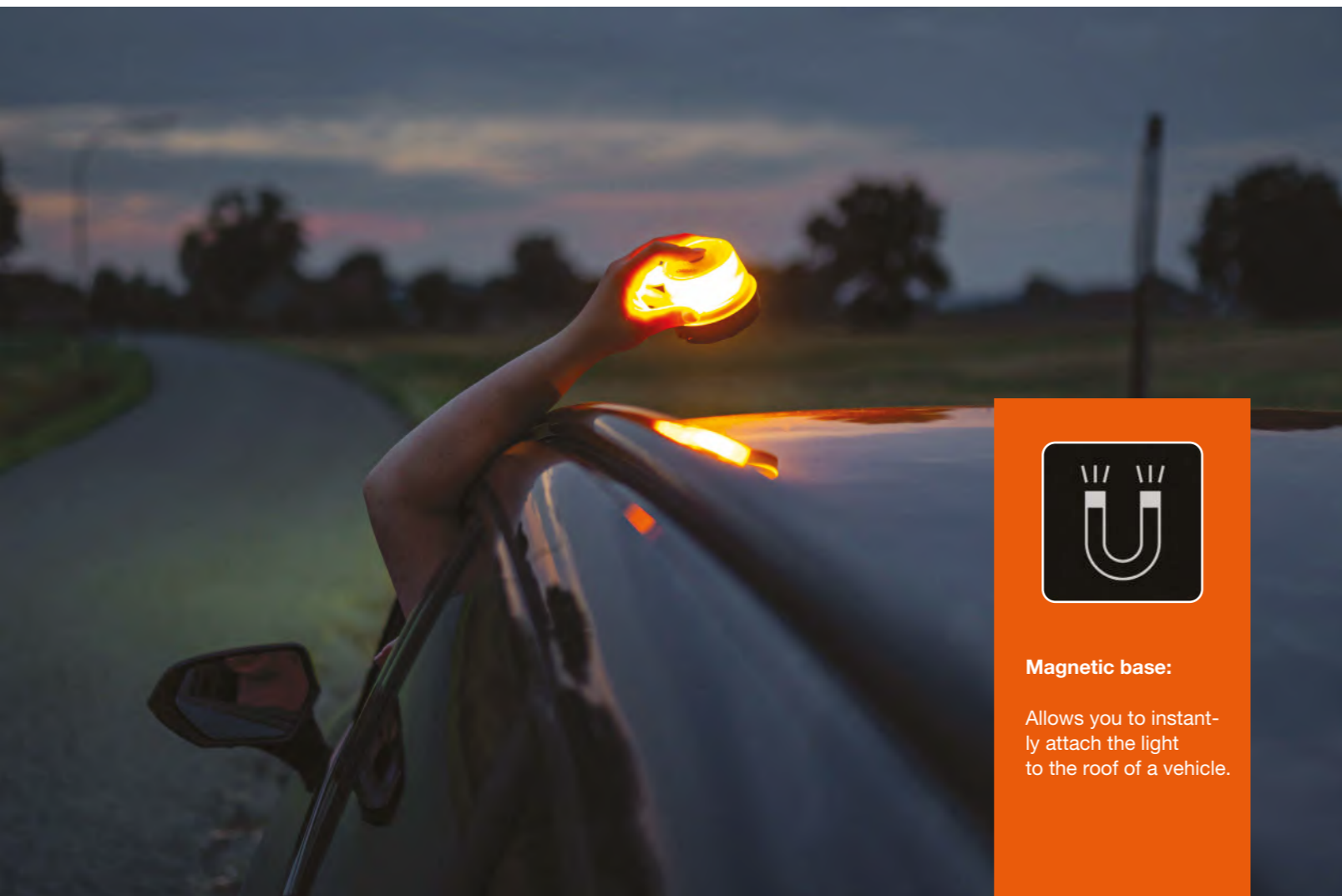

Magnetic base:

Allows you to instantly attach the light to the roof of a vehicle.

4 Warning and safety lights

For roadside repairs and emergencies

OSRAM LEDguardian® lights are a valuable tool for roadside repairs in low-visibility conditions. Their compact design and magnetic base allow for easy storage and fast installation, while powerful flashing LEDs alert other road users to your position in an emergency situation.



IP- & IK-Protection classes:
Tested and validated in our DIN certified environmental simulation laboratory for extreme external influences regarding water, dust, impacts, heat, cold and permanent vibration.



360° rotation:
The flashing orange light rotates, improving visibility and enhancing safety.



Guarantee:
LEDguardian® warning and safety lights are backed by a 2-year guarantee.¹⁾

¹⁾ For precise conditions please refer to www.osram.com/am-guarantee.

Light is safety

Be prepared – with OSRAM LEDguardian® warning and safety lights. The 360° flashing orange warning light function of the OSRAM LEDguardian® warning lights are visible from a great distance and can provide crucial information about a dangerous situation in road traffic in an emergency.

With long-lasting high-power LEDs you can draw attention to yourself by day and night and preventively make other road users aware of a dangerous situation such as a broken-down vehicle in traffic.



See and be seen with OSRAM

In contrast to a warning triangle, it alerts other road users to an unusual situation on the road by actively flashing, compared to a simple reflection such as that of a warning triangle. That's why warning lights are the ideal LED accessory for drivers who want to be equipped for any serious situation.

Always available when required

The compact design allows you to stow the warning light within easy reach in the car and, if required, it can be quickly and easily attached directly to the vehicle roof thanks to the magnetic function.

The LEDguardian® warning lights have been tested and validated in our DIN EN ISO/IEC 17025 certified environmental simulation laboratory for extreme external influences in terms of water, dust, heat, cold and impacts from falls. With the IP protection class IP54, the OSRAM LEDguardian lights are insensitive to water, dust and shocks.¹⁾



¹⁾ Please observe any special requirements and laws in countries outside Germany regarding the use and operation of an additional warning light in road traffic.

LEDguardian® ROAD FLARE Signal TA20

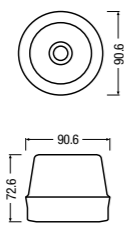

LEDSL104

A rechargeable amber warning light with 360° flashing and magnetic base.

Features

- Officially approved for road use in Germany in accordance with § 53a section 3 TA20 StVZO¹⁾
- Officially authorized by TÜV & KBA / TA20, CE, UKCA certification
- Up to 2 000 K
- 18 high-quality longlife LEDs
- 360° flashing amber warning light
- Protection class: IP54

Benefits

- Magnetic base for easy installation on roof
- Water, dust, and high wind resistance
- Rechargeable battery, runtime up to 15 h (USB-C cable included)
- Non-slip, dirt-repellent surface
- Small, compact, lightweight
- 2-year guarantee²⁾

LEDguardian® ROAD FLARE Signal V16

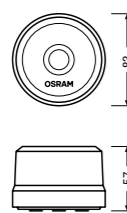

LEDSL102

A battery-powered, long range amber warning light with 360° flashing, and magnetic base.

Features

- 140 lm light output and up to 1 000 m lightrange
- Up to 2 000 K
- 12 high-quality long-life LEDs
- 360° flashing amber V16 regulated warning light and CE certified
- Protection class: IP54

Benefits

- Due to the magnetic function the LED warning light can be conveniently attached to the car and other vehicles
- Water, dust, and high wind resistance
- Non-slip, stable standing feet
- Small, compact, lightweight
- 2-year guarantee²⁾

LEDguardian®

range



Name

LEDguardian®
ROAD FLARE Signal TA20

LEDguardian®
ROAD FLARE Signal V16

Product number

LEDSL104

LEDSL102

EAN

4062172295840

4062172184359

Voltage (V)

3.7

9

Watts (W)

2.2

6

Max Lumen output (lm)

140

140

Colour

Amber

Amber

Kelvin (K)

2000

2000

1) Please observe any special requirements and laws in countries outside Germany regarding the use and operation of an additional warning light in road traffic.
2) For precise conditions please refer to www.osram.com/am-guarantee.

**Download the latest OSRAM
Automotive catalogue to see our
full range of lighting products.**
www.osram.com/am-catalog-digital



**Not sure which lamps fit your customer's
vehicle? Use our online lamp finder tool
to find out.**
www.osram.com/vehiclelamps



**Stay up to date.
Follow OSRAM Automotive on social media**

Facebook
www.facebook.com/osramautomotive



Instagram
www.instagram.com/osram.automotive



YouTube
www.osram.com/am-youtube



Distributor:

OSRAM GmbH

Head office:

Marcel-Breuer-Strasse 4
80807 Munich, Germany
Phone: +49 89 6213-0
Fax: +49 89 6213-2020
www.osram.com

OSRAM