

# CATALOG 2026

Master tools sets 



Organization and storage 



Hand sockets and accessories 



Impact sockets and accessories 



Mechanical wrenches 



Torque tools 



Driver tools 



Pliers, snips and cutters 



Striking and struck tools 



Non-sparking and insulated tools 



Pipe tools 



Pullers and vises 



Equipment, automotive tools and hydraulics 



Greaseguns, oils pumps and other 



Diagnostic and measuring tools 



Cargo handling 



Portable power tools 



Equipment 



Pneumatic tools 



Cutting and grinding tools 



Agriculture and gardening 



Construction 



Safety equipment 



Lighting and electrical equipment 



Miscellaneous tools 



Locksmithing 



Marketing products 





























**URREA**  
SUPERIOR QUALITY AFFORDABLE TOOLS

**SURTEK**  
TOOLS FOR SPECIALISTS

**Lock** Always secure

# UNITS INDEX

<b>01</b>		MASTER <b>TOOL SETS</b>	23
<b>02</b>		ORGANIZATION <b>AND STORAGE</b>	63
<b>03</b>		HAND SOCKETS <b>AND ACCESSORIES</b>	95
<b>04</b>		IMPACT SOCKETS <b>AND ACCESSORIES</b>	155
<b>05</b>		MECHANICAL <b>WRENCHES</b>	183
<b>06</b>		TORQUE <b>TOOLS</b>	223
<b>07</b>		DRIVERS <b>TOOLS</b>	229
<b>08</b>		PLIERS, <b>SNIPS AND CUTTERS</b>	281
<b>09</b>		STRIKING <b>AND STRUCK TOOLS</b>	307
<b>10</b>		NON-SPARKING <b>AND INSULATED TOOLS</b>	325
<b>11</b>		PIPE <b>TOOLS</b>	341
<b>12</b>		PULLERS <b>AND CLAMPS</b>	355
<b>13</b>		AUTOMOTIVE <b>AND HYDRAULIC TOOLS</b>	369
<b>14</b>		GREASE, GUNS, OIL PUMPS <b>AND OTHER FLUID DISPENSER</b>	413
<b>15</b>		DIAGNOSTIC <b>AND MEASURING TOOLS</b>	425
<b>16</b>		CARGO <b>HANDLING</b>	445
<b>17</b>		CORDLESS <b>ELECTRIC POWER TOOLS</b>	473
<b>18</b>		GASOLINE <b>GENERATORS</b>	477
<b>19</b>		PNEUMATIC <b>TOOLS</b>	479
<b>20</b>		CUTTING <b>AND GRINDING TOOLS</b>	513
<b>21</b>		AGRICULTURE <b>AND GARDENING</b>	565
<b>22</b>		CONSTRUCTION <b>TOOLS</b>	587
<b>23</b>		SAFETY <b>EQUIPMENT</b>	603
<b>24</b>		LIGHTNING <b>AND ELECTRIC EQUIPMENT</b>	633
<b>25</b>		MISCELLANEOUS <b>TOOLS</b>	635
<b>26</b>		<b>LOCKSMITH</b>	647
<b>27</b>		MARKETING <b>PRODUCTS</b>	695



**TABLE OF CONTENT:**

It serves as a navigational guide for readers to quickly locate specific information that includes:

1. **Product** icon chart.
2. **Product** image.
3. **On Request** Product available in Mexico.
4. **Product** part number (SKU).
5. **Primary** description and specs.
6. **Sold by quantity** (bulk or individual).
7. **Packaging**.
8. **Video** link.
9. **Related** or similar products.
10. **NEW** **New product** Confirm the release date with your sales manager.
11. **Product** highlights.
12. **IMPROVED PRODUCT** Improved product.
13. **URREA SURTEK** Brand.

**3/4" IMPACT WRENCH TWIN HAMMER SYSTEM AND METRIC SOCKET SET** **URREA**

1. **SUPER DUTY** **METRIC** **3/4"** **6** **3/4" DRIVE** **NEW** **SOCKETS** (with 15S) **10.** **9.**

2. **10 PIECES** **8.** **VIDEO**

7.

ITEM	PIECES	CHUCK	BREAKAWAY TORQUE	⊞
UP776KM	10	3/4"	1200 ft-lb	1

4. 5. 6.

**GRAY POLYPROPYLENE ROPES WITH REEL** **SURTEK** **13.**

**PROFESSIONAL USE** **ECO FRIENDLY PRODUCT** **IMPROVED PRODUCT** **12.**

11.

- Eco-friendly rope made from recycled polypropylene.
- Waterproof and resistant to mold, mildew, and rot for long-lasting performance.
- Stronger than natural fiber ropes, offering greater durability and reliability.
- Roll weight tolerance of +/-5% ensures consistent quality.

**PRICE PER KG**

ITEM	ROPE DIAMETER	WEIGHT PER LB	FT PER REEL	WEIGHT PER REEL	⊞	AVAILABLE
CUEP4	5/32"	164 ft/lb	3,248'	22 lb	1	On Request <b>3.</b>
CUEP6	1/4"	79 ft/lb	3,563'	49 lb	1	On Request
CUEP8	5/16"	51 ft/lb	2,287'	49 lb	1	✓
CUEP10	13/32"	36 ft/lb	2,001'	60 lb	1	✓
CUEP13	1/2"	19 ft/lb	1,250'	68 lb	1	✓

**Informative** video link

**Product** video link

**Content** link

**Product innovation.**

**Improved product.**

**INDEX:**

**Catalog includes**

2 types of index:

- ALPHANUMERIC **INDEX**
- ALPHABETICAL **INDEX**

Pages 705 to 732: contains all item numbers sorted by alphanumeric order. Pages 2 to 8: Contains all product descriptions sorted by alphabetical order despite their part number, where items are located.

IMAGES ARE ILLUSTRATIVE ONLY AND MAY VARY.

- Urreaprofessionaltools**
- @urraprofessionaltools**
- @urreaprofessionaltools1753**

# ALPHABETICAL INDEX

1" drive air impact wrenches	506	Air needle scaler	489	Bimaterial handle nut screwdrivers	234
1" drive hand sockets	142	Air nibbler	486	Bimaterial handle screwdrivers	232
1" drive impact sockets	175	Air polishers	510	Bimaterial handle screwdrivers combination set	234
1" drive sockets	142	Air ratchets	494	Bi-metal hacksaw blades	563
1" square composite pneumatic impact wrenches	500	Air regulators	481	Bimetal hole saws	542
1/2" drive hand sockets	128	Air sander	490	Bits	262
1/2" drive sockets	128	Air scissors	486	Black combination wrenches	198
1/2" drive air impact wrenches	497	Air screwdrivers with torque control	487	Black drill bits	528
1/2" drive impact sockets	163	Airbrush	509	Blade replacements	595
1/2" drive socket sets and air ratchets	495	Alarm padlocks	670	Blades	550
1/2" square composite pneumatic impact wrenches	501	Allen keys	248	Block and tackle	463
1/4" drive impact sockets	157	Aluminum oxide mounted bits	560	Blue handle screwdrivers	240
1-1/2" drive impact sockets	178	Aluminum oxide wheels	561	Bodywork hammers	372
18 V li-ion cordless power tools	475	Aluminum pipe wrenches	349	Bolt cutters	282
20 V li-ion cordless impact wrenches	474	Aluminum tapes	637	Booster cables	395
2-1/2" drive impact sockets	179	Amber handle nut drivers	238	Boots	629
3/4" drive hand sockets	138	Amber handle screwdriver	237	Bow saw	569
3/4" drive sockets	138	Anatomic face shield	611	Box wrenches	208
3/4" drive air impact wrenches	500	Angle air grinders	489	Brackets of steel	641
3/4" drive impact sockets	170	Annular cutters	545	Brake lining thickness gauge	375
3/4" square composite pneumatic impact wrenches	499	Anti splash funnels	419	Brake pad spreaders	376
3/8" drive hand sockets	118	Anti-pry padlocks	656	Brake spring pliers	375
3/8" drive sockets	118	Anti-slip tapes	631	Brick trowels	589
3/8" drive impact sockets	159	Anti-vibration hammers	316	Bronze hammers	318
3/8" drive socket sets and air ratchets	494	Auger drill bits	519	Bronze punches	313
3/8" square composite pneumatic impact wrenches	501	Automatic pullers	356	Brooms	566
<b>A</b> Abrasive brushes	540	Automotive multimeters	429	Brown packing tape	638
Abrasive stones	560	Automotive tool sets	30	Brushes	600
Abrasive wheels	561	Automotive tools	370	Brushes, rollers and painting accessories	601
Accessories for hand sockets	143	Aviation industrial sets	31	Bucket grease pump	422
Accessories for impact sockets	179	Aviation tin snips	305	Bucket oil extractor pump	418
Accordion-style boxes	64	Axes	569	Bucket opener	602
Adapter with pin	280	<b>B</b> Back support belts	618	Bungee cords	460
Adapters	143	Backpacks	698	Bus lug nut wrench	393
Adapters for verifier	392	Ball mounts	370	<b>C</b> Cabinet accessories	83
Adhesive tapes	638	Ball pein hammers	319	Cabinet screwdrivers	233
Adjustable wrench	184	Bar clamps	365	Cabinets	76
Adjustable wrenches	184	Barrel bolts	692	Cable and wire cutters	305
Adjustable wrenches 1000 V	328	Barrel wrench	424	Cable lock with key	669
Adjustable wrenches with handle	184	Bars	308	Cable pliers	298
Adjuster puller	356	Bastard files	553	Cable staples	634
Air drills	511	Battery chargers	475	Calipers	439
Air hammers	493	Bearing removers	376	Cape chisels	313
Air hammers and accessories	493	Bearing separator	357	Caps	698
Air hoses	482	Bicycle locks	670	Car ramps	412
Air impact wrenches	497	Bimaterial handle electronic pliers	294	Carbide wheels	561
Air impact wrenches sets	40	Bimaterial handle flexible putty knives	596	Carbon scrapers	323

Carpenter's brushes	541	Concrete drill bits	515	Double-arm utility hooks	74
Carpenter's pincers	305	Cones	632	Drain cleaners	342
Carpenter's planes and scrapes	541	Connector sets	579	Drift punches	313
Carving chisels	553	Connectors	481	Drive hand sockets 1/4"	112
Cash boxes	655	Construction line	589	Drive impact adapters	179
Caster set for jobsite boxes	64	Contractor hoses	583	Drive sliding t-handles	143
Caster wheels for trunk	64	Coples	481	Drive sockets 1/4"	112
Casters	468	Cordless angle grinder 18 V	475	Drive speed handles	144
Caulking guns	599	Cordless angle grinders	476	Drive torx bit sockets	116
Center drill bits	534	Cordless hammer drill 18 V	475	Drum brake adjusting tool	375
Center drills	534	Cordless impact driver 18 V	475	Drywall stits	646
Centering points	314	Cordless impact driver 20 V	476	Ductile iron clamps	364
Chain hooks	448	Cordless impact wrenches	476	Dumper	599
Chain pipe cutters	345	Corner brackets	641	<b>E</b> Ear protection	612
Chain safety tool set	388	Cotton gloves	628	Elastic back support belts	619
Chain turnbuckles	452	Countersinks	534	Electric chain hoists with chain brake system	463
Chain wrench replacement parts	348	Cowhide leather sleeves	623	Electric hoists	463
Chain wrenches	348	Cowhide welding gloves	625	Electrician pliers	288
Chains	446	Cranes	408	Electrician tool sets	32
Chalk line	444	Crimping pliers	299	Electronic oil extractor pumps	416
Chin straps	607	Cross lug wrench	394	Electronic repair tool set	247
Chisel holder	313	Crowfoot wrenches	127	Electronics Pliers	293
Chisels	311 y 515	Current tester	396	Electronics tools	427
Chopping axes	569	Cushion grip handle interchangeable screwdrivers	245	Endless hose clamps	636
Circle cutter	542	Cushion grip handle screwdrivers	236	Engine cleaning blowgun	390
Clamp pliers	390	Cut resistant gloves	627	Engine timing tools	392
Clamp-on multimeters	429	Cutter tile plier	596	Engine tools	384
Clamps	363	Cutters	547	Entry latches	671
Claw hammers	321	Cylindrical door knobs	681	ESD Precision Screwdriver	246
Click torque wrenches	226	Cylindrical handles	676	ESD Screwdrivers	246
Closet accessories	686	<b>D</b> Damaged thread lug nut remover	378	Expansion wrenches 1000 V	328
Closet rails	687	Dead blow hammer	318	Extensions	144
Club hammers	318	Deadbolts	677	Extensions for hand sockets	144
Coated cut resistant gloves	627	Dies for threader	354	Extra-long combination wrenches	192
Cobalt drill bits	524	Digital locks	682	Eye hooks	448
Cold chisels	311	Digital power clamp multimeter	430	<b>F</b> Face hammers	320
Combination drive socket sets	96	Displays	700	Fan puller	391
Combination lock box	655	Doble head inflator	480	F-Clamps	365
Combination padlocks	666	Dog chains	636	Feeler gauges	385
Combination sets	24	Dollies	454	Fencing plier	296
Combination tool set	32	dolly blocks	371	Files	553
Combination tool set 1000 V	326	Door guard with chain	691	Filter regulators	481
Combination wrenches	187	Door hasps	693	Fish tapes	598
Combined socket sets	96	Door seal	690	Fixed cabinets	76
Component holding clamp	295	Door stops	689	Fixed steel workbenches	74
Compressor accessories	480	Double action hinges	653	Fixed workstation	76
Concrete chisels	316	Double drive ratchets	151	Flare nut wrenches	214

Flaring tools	343	Grease pumps	423	Honing stones	560
Flat striking wrenches	219	Groove joint pliers	295	Honing tools	384
Flex head wrenches	199	Groover	599	Hook and eye turnbuckles	452
Flexible cable hoses	634	<b>H</b> Hacksaw frames	562	Hooks	448
Flexible combination wrenches	199	Hacksaws	562	Hose clamp pliers	390
Flexible oilers	414	Half cut pincers	305	Hose clamps	636
Flexible putty knives	596	Hammer pullers	358	Hose PVC cutters	573
Flexible sockets	116	Hammers	316	Hose reel	399
Flexible wrenches	199	Hammers with caps	320	Hoses	582
Floats	597	Hand impact interchangeable bit screwdriver	243	Hub center sockets	376
Flooring knife	546	Hand pallet truck spare parts	463	Hub puller	356
Fluid extractor pumps	416	Hand pallet trucks	461	Hydraulic body repair kits	372
Folding hex keys	259	Hand pullers	467	Hydraulic bottle jack	405
Forged C-clamps	364	Hand saws	564	Hydraulic door closers	688
Forged forks	566	Hand socket and accessory set	327	Hydraulic engine cranes	409
Fork separators	374	Hand sockets 1/4"	114	Hydraulic jacks	402
Fruit collector	571	Hand trowels	598	Hydropneumatic jack	405
Fuel injector clean set	389	Handcarts	454	<b>I</b> Impact adapters	179
Fuel line disconnect tools	383	Handle sets	674	Impact extensions	180
Fuel testers	392	Handle taping knives	596	Impact handles	181
Furniture for exhibition	702	Handles for impact sockets	181	Impact shock absorbers	615
<b>G</b> Galvanized chains	447	Handles for sockets	181	Impact socket extensions	180
Galvanized steel chains	447	Handles with mortise mechanism	673	Impact sockets	157
Garden brooms	566	Harmonic balancer pullers	356	Impact sockets and accessories	156
Garden hoses	582	Harness	613	Impact universal joints	181
Garden leaf broom	566	Hat hooks	693	Impact wrenches	219
Garden trowel	575	Heavy-duty fixed jaw pullers	363	Impact wrenches 18 V	475
Gardener's bow	569	Helmets	606	Impact wrenches 20 V	476
Gardening gloves	628	Hex key set	253	Industrial basic tool sets	28
Gasket scraper	401	Hex power bits	272	Industrial intermediate sets	26
Gasoline generator	478	Hexagonal bit adapter	279	Industrial master sets	24
Gate trolleys	687	Hexagonal bit sockets	117	Industrial sets	24
Gauges	380	High-leverage box-end wrenches	217	Industrial sets with modular organization system	44
Gear and bearing separator	357	High-leverage wrench bars	216	Infrared thermometer	432
Gear puller	357	High-leverage wrenches	217	Injector cleaner	389
Gear spare parts	225	High-security padlocks	656	Inspection mirrors	400
Generators	478	High-speed steel drill bits	522	Insulated tools	326
Glass and tile drill bits	534	High-speed steel taps	558	Insulating tapes	639
Glass cutter	545	Hinge handles	145	Interchangeable bit screwdriver	244
Gloves	624	Hinge handles for hand sockets	145	Interchangeable bits	276
Goat leg pulley puller	356	Hinges	652	Interchangeable cap	321
Gondola bars	704	Hinges for ironwork	654	Intermediate chest	86
Gondola shelves	703	Hoes	574	Internal pipe wrenches	184
Go-through sockets	96	Hoists	463	Irrigation accessories	577
Gouges	553	Hole saw	543	Irrigation hoses	584
Gray tapes	637	Hollow punch	324	Irrigation nozzles	579
Grease guns	419	Hones	374	Irrigation water spray guns	580

<b>J</b> Jack adapter	408	Long hooks for series	77	Metal stake	578
Jack stands	412	Long L-Type Allen keys	257	Metal tool boxes	67
Jacks	402	Long L-Type hex keys	257	Metal Toolboxes	65
Jaw pullers	360	Long reach pliers	295	Metal utility cart with drawers	72
Jaws for bench vises	367	Long tapes	434	Metal utility carts	72
Jaws for pipe wrench	351	Long T-handle Allen keys	248	Metallic fold-out toolbox	64
Jaws for Stillson wrench	351	Long wood handle shovels	590	Micrometers and vernier caliper	432
Jobsite boxes	64	Loppers	572	Mini cranes	467
Jumper cables	395	L-Shape Allen keys	257	Mini electronics pliers	294
<b>K</b> Keychains	696	L-Type hex key set	253	Mini pipe cutters	345
Keys boxes	655	L-type hex keys 1000 V	331	Mixing hoes	588
Knee pads	622	Lubricant handling equipment	414	Mobile work center	85
Knives	546 y 550	Lug nut wrench	393	Modular boxes	67
Knob locks	678	<b>M</b> Machetes	571	Modular organization sets	45
Knob sets	678	Magnetic pick-up tools	401	Modular plastic tool boxes	67
Knot wire	540	Magnetic trays	400	Morse drill bits	533
<b>L</b> Ladders	641	Magnetizer-demagnetizer	243	Mosquito netting fabrics	644
Laminated padlocks	665	Mailboxes	655	Motorcycle tire wrench	379
Laser distance meters	436	Mallets	323	Mounted points	560
Laser levels	442	Manual hoists	464	Mounted points for castings	561
Latex gloves	628	Manual staplers	640	Multimeter accessory	430
Lather tools bits	534	Marking points	314	Multimeter sets	426
Leaf rakes	567	Masking tape	602	Multimeters	427
Leather cases	92	Mason's line	589	Multimeters sets with tools	427
Leather gloves	625	Mats	697	Multipurpose case	90
Leather tool cases	92	Measures tape	436	Multipurpose movable panel	77
Letters	316	Measures tapes	436	Multi-tool knives	552
Level hoses	589	Measuring tapes	437	Multi-tool pliers	297
Levels	441	Measuring tool set	39	<b>N</b> Nail pry tools	380
Lever action oil extractor pumps	418	Measuring tool sets	39 y 442	Needle torque wrenches	226
Lever oil extractor pumps	417	Mechanic creeper casters	399	Non-sparking screwdrivers	338
L-handles	146	Mechanic creepers	398	Non-sparking adjustable wrenches	334
L-handles for hand sockets	146	Mechanic gloves	624	Non-sparking brushes	340
Lifelines	616	Mechanic stethoscope	389	Non-sparking chisels	338
Lifting straps	457	Mechanic stool	397	Non-sparking combination wrenches	335
Lifting table carts	460	Mechanic stool casters	397	Non-sparking expansion wrenches	334
Lineman belts	616	Mechanic stools	397	Non-sparking flat striking wrenches	336
Linemen's pole strap	615	Mechanic tool sets	35	Non-sparking hammers	339
Linemen's safety belt	615	Mechanic's wrenches	206	Non-sparking offset striking wrenches	336
Links	447	Mechanical jacks	404	Non-sparking pipe wrenches	337
Load trolleys	467	Mechanic's pliers	296	Non-sparking pliers	338
Loading platforms	454	Mesh screen	644	Non-sparking putty knives	340
Locking pliers	301	Mesh tarps	643	Non-sparking spline wrenches	335
Locks	671	Metal boxes	64	Non-sparking structural wrenches	337
Locks and keys for cabinets	82	Metal drill bits	522	Non-sparking tools	334
Locks for aluminum doors	683	Metal jobsite boxes	64	Non-sparking wedges	338
Locks for cabinets	82	Metal rod tyers	588	Non-sparking wrenches	334

# ALPHABETICAL INDEX

Notched hand trowels	598	Pipe threaders	353	Power drive hexagonal bits	272
Notebook	696	Pipe tools	342	Power drive slotted bits	268
Numbers	694	Pipe wrench	349	Power drive square bits	272
Nylamid socket set	377	Pipe wrench jaws	351	Power drive torx bits	272
Nylamid sockets	377	Pipe wrenches	349	Power nut driver bits	267
Nylon gloves	627	Pipe yoke vise	352	Power nut setters	267
<b>O</b> Obstruction wrenches	210	Piston ring compressor set	389	Power tools	474
Octagonal hammers	316	Pitchforks	566	Power tools batteries	474
Offset cabinet screwdriver	243	Pitman puller	357	Power tools chargers	474
Offset striking wrenches	221	Planer blades	542	Precision screwdriver sets	247
Offset wrenches	221	Plastic cover	703	Precision screwdrivers	246
Oil control guns	424	Plastic stacking bins	72	Precision vises	363
Oil extractor pumps	416	Plastic ties	636	Preset torque wrenches	226
Oil filter wrench	381	Plastic tool boxes	72	Pressure tester	391
Oil filters accessories	380	Plastic toolboxes	65	Price hooks	703
Oilers	414	Plastic utility cart	74	Promotional displays	700
One-handed pneumatic grease gun	490	Platform carts	454	Promotional items	696
Open-end wrenches	206	Pliers	283	Promotional pens	697
Open-end wrenches 1000 V	328	Pliers 1000 V	332	Promotional textiles	698
O-rings	182	Pliers sets	55	Protective equipment	604
O-rings for impact sockets	182	Plug remover	356	Pruning shears	572
<b>P</b> Packing tapes	638	Plumb bobs	593	Pullers	356
Padlocks	656	Plumbers tool set	41	Pulley holder	384
Padlocks with alarm	657	Plumbing set	353	Pulley puller	356
Paint brushes	600	Plumbing snake	342	Pulley with hook for wire	451
Paint mixers	600	Pneumatic brad nails	484	Pulleys	451
Paint roller frames	601	Pneumatic cutter	487	Pump sprayers	576
Paint spray guns	507	Pneumatic drills	511	Punches and points	313
Paint telescopic extensions	602	Pneumatic grinder	496	Punches and points	313
Paint tray	602	Pneumatic impact wrench	497	Putty knives	596
Panic bars	684	Pneumatic moto tools	496	PVC boots	631
Parking stop	632	Pneumatic nailers	483	<b>Q</b> Quick hooks	447
Pear-head ratchet	278	Pneumatic nailers and staplers	483	<b>R</b> Racks for tools	699
Personal protective equipment	604	Pneumatic polishers	510	Radiator pressure test master	391
Phosphate finish combination wrenches	198	Pneumatic riveters	510	Raffias	453
Pick mattock	593	Pneumatic staplers	485	Railroad tool sets	34
Picks	593	Pneumatic tool sets	39 y 497	Rain suits	620
Pilot drill arbors	543	Pneumatic tools	483	Raincoats	620
Pin punches	314	Pneumatic/air accessories	480	Rakes	568
Pins	182	Polish chains	446	Ratches	147
Pins for impact sockets	182	Polypropylene rope	453	Ratchet tie down strap	459
Pipe benders	347	Portable toolboxes	64	Ratchets for hand sockets	147
Pipe chain vise	352	Portable workbenches	363	Rebar tier	588
Pipe clamp	366	Post hole digger	574	Rebar wrenches	589
Pipe cutter	344	Post hole diggers	574	Reciprocating air saw	483
Pipe cutter blades	344	Power bits	268	Red handle screwdrivers	239
Pipe cutters	344	Power connectors	395	Red sandpapers	642



Reflective triangles	632	Screwdrivers 1000 V	329	Speed handles	144
Reflective vests	617	Screwdriving tools	230	Spider mesh hoses	583
Reinforced tarps	643	Screws for extractors	359	Spiral flute pipe extractors	358
Residential locks	671	Scythe stone	560	Spline combination ratcheting wrenches	205
Retaining ring pliers	283	Sds max chisels	515	Spline sockets	134
Reusable earplugs	612	Sds plus chisels	515	Split leather aprons	623
Reversible chain wrench	348	Security boxes	655	Split leather gaiters	623
Reversible jaw pullers	362	Security cable	615	Splitting axes	570
Reversible ratchets	147	Security safes	655	Spokeshave	542
Revolver type screwdriver	245	Sensor sockets	383	Spoon tire irons	380
Ribe bit sockets	126	Service wrenches	215	Sprayers	576
Rigid back support belts	618	Shackles	449	Spring clamps	366
Riveters	645	Shade nets	643	Spring compressor	388
Rivets	646	Sharpening stones	560	Sprinklers	577
Roll door padlocks	667	Shears	572	Square drive screwdrivers	144
Roller cabinets	79	Shelf brackets	641	Squares	440
Roller refills	601	Short combination wrenches	187	Stainless steel straps	636
Ropes	453	Short L-Shape Allen keys	255	Staples for manual stapler	640
Roughing end mills	544	Short L-Type hex keys	258	Staples for pneumatic stapler	486
Round files	556	Short T-handle Allen keys	250	Steel drill bits	522
Router drill bits	520	Short T-handle hex keys	250	Steel drum dollies	454
R-series handle screwdriver	239	Shovels	590	Steel fish tapes	598
Rubber head mallet	323	Sidewalk groover	599	Steel knives	546
Rubber straps	460	Silicone tapes	639	Steel padlock sets	661
<b>S</b> Sae industrial railroad maintenance tool sets	34	Slide hammer pullers	358	Steel padlocks	662
Safety boots	629	Sliding t-handles	143	Steel wire ropes	446
Safety clothing	623	Slings	457	Steel wire ropes with thimbles	446
Safety cones	632	Slip joint pliers	296	Steering tools	374
Safety footwear	629	Snap ring pliers	283	Step drill bits	533
Safety glasses	607	Snips	305	Stiff putty knives	596
Safety gloves	624	Socket clips	93	Stillson	349
Safety goggles	611	Socket rail and clips	93	Straight jaw pullers	361
Safety helmets	606	Socket rails	93	Straight oilers	414
Safety knee pads	622	Socket sets and accessories	96	Straps	460
Safety toolboxes	65	Socket sets and hand accessories	96	Striking points	310
Safety vests	617	Sockets and accessories 1000 V	327	Structural box-end wrenches	222
Safety waterproof tool boxes	65	Sockets for removing oil	383	Structural wrenches	337
Safety wire twist plier	295	Sockets with neoprene	387	S-type hooks	448
Sanders	490	Solid brass padlocks	658	Suction cups	594
Sandpaper	642	Spade drill bits	519	Suspension sockets	396
Satin finish combination wrenches	193	Spare parts for ratchets	153	Swivel chains	447
Satin finish jumbo combination wrenches	194	Spare parts for reversible ratchets	153	Swivel eye pulley	448
Satin-finish sae service wrenches	215	Spark plug pliers	387	Swivel pulleys	451
Scrapers	575	Spark plug sockets	387	<b>T</b> Tampers	593
Screw extractors	358	Specialty hammers	322 y 372	Tap sets	559
Screwdriver socket	144	Specialty tool sets	30	Tape dispensers	638
Screwdrivers	230	Specialty wrenches	214	Tapes	637

# ALPHABETICAL INDEX

Taps	558	Tray for components	45	Wheels	468
Tarps	643	Trays	588	Winch straps	460
Terminal pliers	396	Tree pruners	569	Window trolley	687
Tester for gasoline motors	393	Triangular files	554	Wire and cable cutter 1000 V	333
T-handle Allen keys	248	Trim pad remover	402	Wire brushes	540
T-handle hexagonal keys	248	Trimaterial screwdrivers 1000 V	329	Wire cup brushes	535
Thermos	698	Trolley	467	Wire cutting shears	305
Thimbles	449	Trowels	598	Wire rope clips	450
Thirfors	467	Truck wheel impact sockets	378	Wire stripper	298
Thread chaser	387	Truck wheel sockets	377	Wire utility carts	72
Thread seal tape	640	Truck wrench	381	Wire wheel brushes	537
Threaders	353	Tube benders	347	Wood chisels	553
Threading die	354	Tubular door knobs	680	Wood drill bits	518
Threading dies	354	Tubular handles	674	Wood handle flexible putty knives	597
Thunder torque wrenches	226	Tumbuckles	452	Wood sandpaper	642
Tie-downs	459	Twist socket set with punch	359	Work center	85
Tile cutters	594	Two-dimensional hinges	653	Work stool	343
Tile sets	594	<b>U</b> Universal joints	154	Workbench vises	368
Tile spacers	596	Universal joints for hand sockets	154	Workbenches	363
Timing-advance testers	390	Universal joints for impact sockets	181	Workstation	74
Tin snips	306	Universal tripod	343	Wrenches	184
Tire iron	380	Universal wrenches	348	<b>Y</b> Yellow handle striking screwdrivers	241
Tire wrenches	393	Utility cart	67	Yoke vises	352
Tool bags	91	Utility knives	550	<b>Z</b> Z-type screwdrivers	243
Tool gondola	702	<b>V</b> Valve compressors	388		
Tool holder	90	Valve lapping tool	392		
Tool sets	24	Valve tools	379		
Tool sets for mechanics	35	Vertical cutters	544		
Tool sets in tool pouch or tote	32	Vertical oil extractor pumps	417		
Toolboxes	64	Victor-type chains	446		
Top chest with drawers	79	Vise stands	343		
Torque multipliers	225	Voltage tester	430		
Torque screwdrivers	228	<b>W</b> Walking chains	636		
Torque spare parts	225	Warning tapes	631		
Torque tools	225	Waste oil drain by gravity	381		
Torx bit sockets	123	Waterproof padlock set	664		
Torx female sockets	123	Waterproof padlocks	664		
Torx sockets	116	Waterproof ponchos	621		
Tow hooks	371	Waterproof sandpaper	642		
Tow ropes	371	Waterproof toolboxes	65		
Towing accessories	370	Waterproof trench coat	620		
Tpr caster	471	Welder's kit	604		
Trailer balls	370	Welding helmets	605		
Trailer couplers	370	Welding lens spare	605		
Trailer hook	371	Wheel tools	377		
Transfer pump	418	Wheel weight pliers	379		
Transparent tape	637	Wheelbarrows	588		



# GOOD, BETTER, BEST

We are the **complete solution in tools** where you will find the best of Grupo Urrea all in one place.

Thinking of you and your various needs, we offer a wide range of possibilities with **Good, Better & Best** options within our extensive product catalog.

*Get to know them in detail:*

**GOOD-** General and domestic use tools: **Foy**

**BETTER-** Tools for professional use: **Surtek**

**BEST-** Tools with superior quality, performance and durability: **Urrea**



## GOOD

Wide variety, availability and accessibility.



## BETTER

















Wide variety, availability, accessibility and performance, with an excellent price-quality ratio.











## BEST

Wide variety, availability, technology and innovation, excellent performance, high quality and superior performance.

Choose better, choose quality with our  
**new 2026 catalog**

BRAND	TARGET MARKET	FREQUENCY OF USE	PERFORMANCE	USE
	 <b>INDUSTRIAL USE</b> We offer tools that provide superior performance exceeding industry standards by using the highest quality in all materials we use for the production of our tools. Likewise, we employ the latest technology, innovation, and design processes that ensure the best quality and tool performance for industrial use.	<b>CONTINUOUS</b> 8 to 12 hours of daily use.	12	 MEGA DUTY
			11	 EXTRA DUTY
			10	 HEAVY DUTY
			9	 INDUSTRIAL DUTY
	 <b>PROFESSIONAL USE</b> We provide tool solutions that address all needs due to their extensive variety, performance, accessibility, and availability. Our products exceed expectations, designed for rough and frequent use.	<b>FREQUENT</b> Up to 6 hours of daily use.	7	 MASTER USE
			6	 PROFESSIONAL USE
			5	 GENERAL USE
			4	 GENERAL USE
	 <b>DOMESTIC USE</b> Special tools for light and occasional work, focused on satisfying the needs of all homes.	<b>OCCASIONAL</b> Up to 2 hours of daily use.	3	 GENERAL USE
			2	 DOMESTIC USE
			1	 DOMESTIC USE

 <b>MEGA DUTY</b> For extreme and continuous usage situations. Tools and equipment that withstand the toughest and prolonged use.	 <b>SUPER DUTY</b> For continuous usage and tough applications. Products with high power, performance, and comfort capabilities.	 <b>HEAVY DUTY</b> For situations requiring greater power in frequently used applications. Products that guarantee durability, longevity, and safety.	 <b>INDUSTRIAL DUTY</b> For usage situations where precision, quality, and durability are needed. Products that exceed the most demanding international standards.
 <b>MASTER USE</b> High-strength tools designed for structural maintenance, professional and industrial machinery and tools. Not suitable for use in production lines.	 <b>PROFESSIONAL USE</b> High-strength tools designed for frequent use, providing a great user experience, comfort, and performance.	 <b>GENERAL USE</b> Tools for workshop supplementation. Highlighted by a good balance of design and material quality, offering performance, durability, and ease of use. Ideal for light and everyday tasks.	 <b>DOMESTIC USE</b> Tools with a great price-to-quality ratio. Designed for light and occasional tasks, focusing on covering basic household needs.



**Store**  
CONCEPT



WHY HAVE A

# Store?

MAKE YOUR BUSINESS  
**Profitable**

Have a business model that allows you to **offer and manage your sales** with improved performance, developing the economic potential of your business.

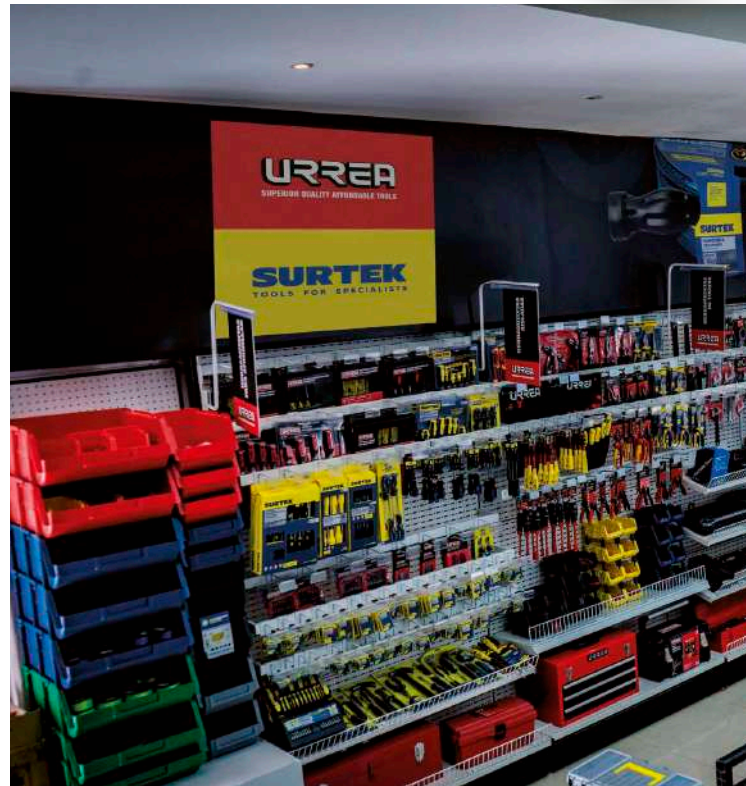

ENCOURAGE

## cross-selling

Increase in sales after its opening.



IMPROVE THE SHOPPING

## experience

100% satisfied customers.



INCREASE TRAFFIC ON THE

## sales floor

20% increase.



INCREASE BRAND

## recognition

and differentiate our brands from competitors.



1907



“Valvulas Carroll” is founded (Carroll faucets).

1963



The tools division is established.

1986



Urrea is established as a commercial brand.

1999



Surtek is launched as a brand.

2003



Development of the STORE concept.

2005



Manufacturing facility for construction tools settled.

2014

GREAT PLACE TO WORK®

1st place in the GPTW ranking for Mexico Center & West region as the “best place to work”.

2015



An extension of the Distribution Center is built and Distribution Center in San Antonio, TX is established.

2016



Another extension of main Distribution Center is built.

2017



Fully automated section with pick to light, conveyors and improved processes implemented.

2019



-Certification as “Clean Industry” was accomplished.

-40% increase in picking automated process.

With more than **119 years**, and based on a clear strategy of growth through **quality, innovation, technology and diversification** focus as the added value for our customers, distributors and employees, today we have **presence in more than 25 countries**.

We continue with commitment seeing the future with optimism and trying always to maintain our **values of integrity, honesty and leadership** to keep being the best company in the hand tools market.

Urrea Group has 2 divisions: “Valves faucets and ceramics” and “Total solution in tools”.

+Simpler  
+Faster  
+Safer

**2006**



**Lock** brand is acquired.

**2007**



Urrea completes its first **100 years**.

**2008**



Acquisition of three new plants: **chisels, hoses, and metal boxes**.

**2010**



The **Test and Innovation Center** is inaugurated.

**2012**



**Prolok and Proforza** brands are purchased from Locksmith business.

**2020**



**New distribution center** inaugurated in Southern Mexico.

**2021**



-**Surtek** brand was introduced into the USA market.

-Achievement of the **Great Culture to Innovate** as founder partnership, highlighting it as one of the top 15 most innovative companies in Mexico and ranked first in the Western region.

**2022**



Opening of new distribution centers in **Bogotá and San Antonio TX USA**.

**2023**



Three plants are inaugurated: **sheets, extrusion, and packaging**.

**2025**



New distribution center for **exports and big boxes stores**.

## WHO WE ARE?

GRUPO URREA IS THE ONLY COMPANY THAT MANUFACTURES  
"MECHANICAL TOOLS IN MEXICO"

  
More than **2,200**  
employees

  
**3 leading** brands  
in the market

  
**16,200**  
products in  
our portfolio

  
More than **700**  
releases per  
year

  
**1,100,000**  
tools produced  
per month

  
**387,500 SQF**  
of production  
area

  
We have presence  
in more than **25**  
countries world wide

  
**1.6 MSQF**  
of facilities

  
**7 manufacturing**  
facilities

  
**5 distribution**  
centers

  
**57 production**  
lines

## MANUFACTURING FACILITIES



MANUFACTURING & TRANSFORMATION WITH MORE THAN 1.5 MILLION FT<sup>2</sup>

  
**MECHANICAL TOOLS**  
FACILITY

  
**METAL BOXES & WHEELBARROW**  
FACILITY

  
**INJECTION MOLDING**  
FACILITY

  
**WOOD CONDITIONING**  
FACILITY

  
**ASSEMBLING**  
FACILITY

  
**HOSES MANUFACTURING**  
FACILITY

  
**PAINT CANNING**  
FACILITY

OUR **5 DISTRIBUTION CENTERS** ARE LOCATED IN:

 **EL SALTO**  
JALISCO, MEXICO

**a.** DISTRIBUTION  
CENTER  
**b.** EXPORTS AND  
BIG BOXES STORES

 **VILLAHERMOSA**  
TABASCO, MEXICO

 **BOGOTA**  
COLOMBIA

 **SAN ANTONIO**  
TEXAS, USA

MORE THAN 54,000 FT<sup>2</sup> **OFFICE SPACE, CORPORATE** & WITHIN MFG. PLANT



**4 CORPORATE**  
OFFICES







## VISION

Be the best company with **innovative solutions for our customers, distributors, employees and shareholders.**

## VALUE PROPOSITION

To be the **simplest, fastest and safest provider** for omnichannel business, offering a total solution in tools and hardware products market with the best combination of quality, price, and availability.

## BUSINESS ETHICS

We believe that to achieve the transformation and growth of our country we must start with ourselves. We carry out good corporate governance practices, acting with honesty and transparency in each and every one of our transactions under the legal framework that governs us and in accordance with our code of ethics and business, which points out the behavioral and behavioral norms under those that are governed by the company and our collaborators inside and outside the company.

## ENVIRONMENTAL POLICY

We continuously improve and innovate our processes and products to make them simpler, faster, and safer, while promoting prevention, legal compliance, and the preservation and protection of the environment, with the goal of exceeding the expectations of our stakeholders.

## WE STRENGTHEN THE WORK CULTURE

### BUSINESS MANAGEMENT



**15 YEARS**



**8 YEARS**



**14 YEARS**

### SOCIAL RESPONSABILITY



**15 YEARS**



**5 YEARS**



**2 YEARS**



**12 YEARS**

# ADVANTAGES AND BENEFITS

Greatness is built  
*on smallest details*

We take care of every detail to always offer you the greatest advantages and benefits as our distributor.

## 1 THE GREATEST EXPERIENCE AND INFRASTRUCTURE IN THE HARDWARE SECTOR

You have the support of one of the most important companies in the sector, with more than **119 years** of experience and global presence exporting to more than **25 countries**.

## 2 MARKET AND INDUSTRY KNOWLEDGE

We offer the best tools to develop your channel.

- We conduct market analysis and user demonstrations in different industries.
- Our unique concept of exclusive **STORES**, with multiple advantages and tools such as site analysis and geomarketing research.

## 3 THE MOST PRESTIGIOUS BRANDS AND THE MOST INNOVATIVE PRODUCTS

**16,000+** product portfolio for all needs.



**GOOD**

Wide variety, availability and accessibility.



**BETTER**

Wide variety, availability, accessibility and performance, with an excellent price-quality ratio.



**BEST**

Wide variety, availability, technology and innovation, excellent performance, high quality and superior performance.

**119 years**  
OF HISTORY.

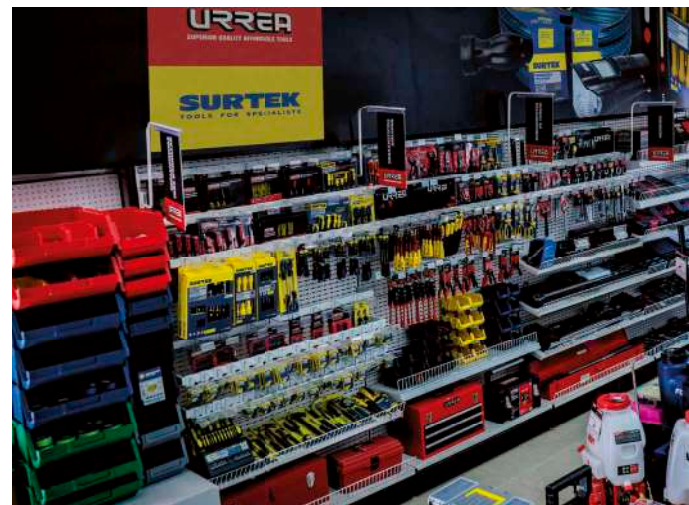

## 4 EXPERTS ALWAYS AT YOUR SERVICE

Expert consultants and a dedicated team. We have the most **innovative tools and platforms** so you can check your sales performance at any time through Urreanet.

  
urreeanet  
DISTRIBUTOR SERVICE

 [usa.urrea.com](http://usa.urrea.com)



**5 WE BOOST YOUR BUSINESS GROWTH**

You maintain complete freedom, we guarantee **the maximum profit margin** and growth that adapts to your needs.

**6 COMPLETE AND TIMELY ORDERS**

We offer you **the most efficient service** throughout the entire logistics chain.

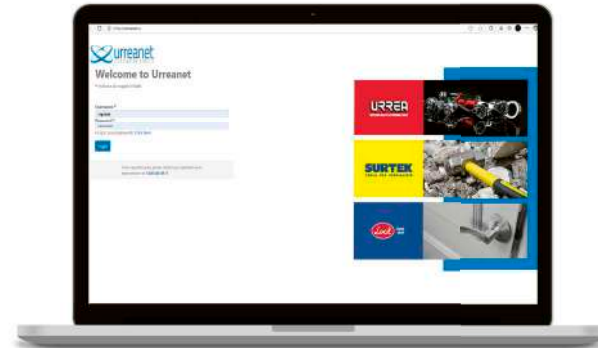

**7 THE STRONGEST WARRANTY ON THE MARKET**

Products with a **100-year warranty** for general hand tools.



**WARRANTED TOOLS**

**8 DIGITAL TRANSFORMATION SUPPORT SERVICES**

We have **extensive experience** in digital marketing, social media, e-commerce, and more.



**9 OUR VALUES**

Together, we develop a lasting business relationship based on our core values:

**RESPECT:**

We offer personalized service based on trust and mutual respect.

**LOYALTY:**

We design business programs and policies to establish strong and lasting relationships that ensure consistency, fairness, and mutual benefit.

**OPENNESS:**

Your suggestions and comments are always welcome; we operate in a culture of continuous improvement.

**COMMITMENT:**

We do not allow the company, our shareholders, or our employees to be distributors. We operate with a conflict-free policy.



## TEST AND INNOVATION CENTER



## COMMITTED WITH INNOVATION

At Grupo Urrea, we are committed to offering the safest tools on the market and keeping our product portfolio at the forefront. That is why we have consolidated the functions of product innovation and development—covering components and raw materials—within our Urrea Test and Innovation Center. This facility, spanning more than 700 m<sup>2</sup>, includes specialized laboratories dedicated to ensuring the quality of every product across our brands, enabling us to provide the best warranty and after-sales service in the market.

All our products are backed by worldwide quality certification bodies and strictly adhere to applicable regulations and standards, supported by certifications and quality management systems such as ISO 9001:2015.

### GENERAL TEST AREA

Tests are carried out on our products in accordance with national and international standards. These include mechanical strength tests, moisture resistance, corrosion resistance, and high-voltage resistance. We also perform mechanical performance tests on bottle-type hydraulic jacks, and measuring tapes, based on applicable Official Mexican Standards (NOM).

### METALURGIC LAB

We test the compliance with specifications for raw materials and product in process, doing metallographic studies such as chemical composition of metals, hardness and analysis of the molecular structure of steels in its different phases.

### CHEMICAL LAB

The quality of the chrome plating, phosphating, and bluing processes is continuously monitored by performing detailed analyses of the chemical concentrations at each stage of these processes, and validating them through accelerated corrosion testing in a salt-spray chamber.

### METROLOGY LAB

Metrological control is maintained for all measurement and testing equipment used across Grupo Urrea by implementing calibration and verification programs that ensure equipment reliability and, consequently, the quality of our products.

In addition, specialized dimensional evaluations are performed thanks to the availability of high-precision and highly versatile equipment.

### PROTOTYPING LAB

New products and innovations go through a prototyping process that leverages 3D printing technology, ensuring that each development meets the defined user functional requirements in terms of efficiency, safety, and durability.

### PACKAGING LAB RESISTANCE TEST

The integrity of product packaging is ensured through validation tests that measure resistance to vibration and oscillation, as well as resistance to external compression forces and free-fall impacts. Additionally, the composition of corrugated materials is analyzed. These evaluations simulate over-the-road shipments from our distribution centers to our distributors, guaranteeing the quality and durability of our packaging throughout the logistics process.





**We continuously improve and innovate** our processes and products to make them simpler, faster, and safer, allowing us to exceed the expectations of our customers, distributors, employees, and shareholders.

Aligned with this commitment to continuous improvement, we received ISO 9001:1994 certification in 1998, followed by ISO 9001:2000 certification in 2004 and ISO 9001:2008 certification in 2010. In 2017, we obtained the ISO 9001:2015 certification and more recently the ISO 14001 in 2023. This certification reflects our constant dedication to maintaining high operational and manufacturing standards, enabling us to offer our customers tools with the best combination of price, quality, and ease of purchase.

## THE NORMS FOR TOOLS ARE STANDARD SPECIFICATIONS CONTAINED IN DOCUMENTS THAT DESCRIBE:

- General aspects of product design.
- General aspects of materials for manufacturing the product.
- Hardness.
- General and critical dimensions.
- Load tests (torsion, flexion, tension, cut, etc.).
- Required marks (such as an indelible markstating country of origin).

Below are the standards-issuing organizations whose requirements Urrea tools and equipment meet or exceed.



**ANCE (Mexico)**  
The Certification and Standardization Association for the Electric Sector.

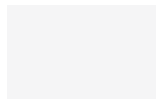

**ASME (USA)**  
ASME - American Society of Mechanical Engineers.



**DIN (Germany)**  
The German Institute for Normalization.



**ANSI (USA)**  
The American National Standards Institute (ANSI).



**Mexican Government**  
The Standards General Office (DGN - Dirección General de Normas) is a branch of the Secretariat of Economy (SE) of the Mexican Government.



**SAE (USA)**  
SAE - Society of Automotive Engineers.



**EMA (Mexico)**  
EMA certifies testing and calibration laboratories in accordance with the Federal Law on Metrology and Standardization and the ISO-IEC-17025-IMNC-2000 standard. Our testing laboratories have been accredited by EMA for compliance with the Mexican standard NMX-EC-17025-IMNC-2000 since October 2003.



**United States Federal Government**  
The General Services Administration (GSA) develops and issues Federal Standards from the United States Government.



**VDE (Germany)**  
Germany's Association for Electrical, Electronic and Information Technologies (Verband der Elektrotechnik, Elektronik und Informationstechnik).

## AFFILIATIONS

**Grupo Urrea** is affiliated with the following internationally recognized organizations.



**(USA)**  
Hand Tools Institute.



**(USA)**  
Specialty Tools and Fasteners Distributors Association.



**(Mexico)**  
National Association for hand tools manufacturers (Asociación Nacional de Fabricantes de Herramientas).

**All warranties are subject to the following conditions:**

The tool must be originally identified with the permanent **Urrea** or **Surtek** brand marking.

The failure must be the result of a **manufacturing defect, either in workmanship or materials.**

The warranty does not apply if the tool has been:

- **Abused, overloaded, modified, tampered with, or misused.**
- **Used without the maintenance specified in the user manual.**
- **Used in highly corrosive environments.**

**Urrea and Surtek reserve the right to evaluate the failure through their engineering department. Urrea and Surtek may choose to either repair or replace the defective tool. The repair or replacement will be carried out through the distributor.**

Some products, such as torque wrenches and torque multipliers, are subject to wear from normal use or excessive torque. Therefore, **the user must provide proper maintenance** as specified for the tool or equipment.

Grupo Urrea is **not responsible for damages or personal injuries** resulting from improper use, abuse, alteration, or use beyond the expected life of its products.

**Important Note:**

**The stamped warranty policy or the purchase invoice must be presented, and the product must be returned complete, undamaged, with all its accessories, and in its original packaging.**



## WARRANTY CHART

Use			Brand	Performance level	Hand Tools	Portable Power Tools	Hydraulic Equipment	Stationary Electrical Equipment	Pneumatic Tools	Torque Tools	Gasoline-powered Equipment
Market	Frequency	Using level									
Factory	CONTINUOUS	MEGA DUTY	URREA <small>EXPERIENCE DUTY TOOLS</small>	12	100 YEAR WARRANTY	3 YEAR WARRANTY					1 YEAR WARRANTY
		SUPER DUTY		11							
		HEAVY DUTY		10							
		INDUSTRIAL DUTY		9							
		MASTER USE		8							
Person	FREQUENT	PROFESSIONAL USE	SURTEK <small>TOOLS FOR SPECIALISTS</small>	7	100 YEAR WARRANTY	2 YEAR WARRANTY					1 YEAR WARRANTY
		GENERAL USE		6							
				5							
				4							
				4							

\*Warranty against manufacturing defects (workmanship and materials).

Warranty valid unless otherwise specified on the product packaging.

\*48 hours on gasoline tools, 4-stroke engines only.

The following products are not covered by the warranty: Thin-wall impact sockets, Thin-wall impact wrenches, Hand and impact adapters, Universal joints, and Non-sparking tools.

\*Does not apply to power tool consumables.



## HAND TOOLS

**Urrea and Surtek, guarantee that the products they offer are free from defects in workmanship and materials.** They commit to repairing or replacing any tool that fails during its useful life under normal conditions of use, in accordance with the specific warranty for each product, at no cost, directly through any authorized distributor.

**Urrea and Surtek, tools are designed to deliver precision, quality, and durability.** They are made from the finest materials, processed with state-of-the-art technology, and manufactured by highly skilled, trained, and experienced personnel.

Surtek's manufacturing processes comply with international standards, ensuring consistency in meeting the strictest specifications. For this reason, **Urrea and Surtek hand tools are guaranteed for 100 years** (Warranty valid except in cases where a special warranty is indicated and/or something different is specified on the packaging and/or product).



**HAND TOOLS**  
IN GENERAL  
(Except where a specific warranty is indicated)

- **Mechanical hand tools**  
Wrenches, pliers, screwdrivers, sockets, etc.
- **For pipes**  
Pipe wrenches, pipe cutters, dies, etc.



## POWER TOOLS



**PNEUMATIC, HYDRAULIC, GASOLINE-POWERED, PRECISION AND MEASURING EQUIPMENT, STATIONARY ELECTRICAL EQUIPMENT**

### 1-YEAR WARRANTY.

Valid in case of defects in workmanship and materials during manufacturing. To claim the warranty, you must go to any Authorized Distributor.

Urrea and Surtek warranty does not cover parts or components subject to natural wear from use, including: lances, hoses, connectors, pressure gauges, wheels, spark plugs, among others.

### 48-HOUR WARRANTY.

The end user may exchange a machine if it presents a verified fault within the first 48 hours after purchase, provided they present the stamped warranty policy or purchase invoice and return the product undamaged, with all accessories and in its original packaging. This warranty can be claimed at any Authorized Distributor.

Urrea is not liable for issues caused by improper use or incorrect mixing of lubricants and fuel in two-stroke engines. For optimal performance and durability, always follow the instructions in the user manual to select the right lubricant.



**PORTABLE POWER TOOLS**

### 48-HOUR WARRANTY.

The end user may exchange a machine if it presents a verified fault within the first 48 hours after purchase. This warranty is valid at any Authorized Distributor. The stamped warranty policy or purchase invoice must be presented, and the product must be returned complete, undamaged, with all accessories and in its original packaging.

### 90-DAY TOTAL SATISFACTION GUARANTEE

If for any reason you're not satisfied with the machine you purchased, you can exchange it for another of a higher level within 90 days, simply paying the price difference. This guarantee is valid at any Authorized Distributor.

**Please note:** Urrea Tools does not provide cash refunds at any time. The guarantee only applies to replacing tools within the same family or type, and only if a higher-level model is available. The machine must be in good condition, returned with its original packaging and accessories, within 90 days of purchase.

### 3-YEAR WARRANTY (URREA) AND 2-YEAR WARRANTY (SURTEK).

Valid in case of defects in workmanship and materials during manufacturing. To claim the warranty, you must visit any Authorized Distributor.



**TORQUE WRENCHES**

The end user may exchange a torque wrench if it presents a verified fault within the first 48 hours after purchase. This benefit is valid at any Authorized Distributor.

Urrea torque wrenches are factory-calibrated, and calibration is guaranteed for one year from the date of purchase.

**90 DAYS**  
TOTAL  
SATISFACTION

**3 YEAR**  
WARRANTY  
URREA

**2 YEAR**  
WARRANTY  
SURTEK

• Portable power tools.



## WHAT IS NOT COVERED BY WARRANTY?

### CONSUMABLES AND ACCESSORIES





The following items are never covered by warranty: drill bits, ratchets, hacksaw blades, saws, sandpaper, knives, screwdriver bits, blades, threading dies and taps, cutting and grinding discs, filters, circle cutters, wire brushes, files, stones, taps, carbon brushes, hoses, screwdriver tips, cabinet accessories, compressors, pressure washers, wheelbarrows, brush cutters, bearings, and irrigation components. Products listed in the catalog as consumables, accessories, and spare parts are not covered by warranty because they contain components subject to natural wear or breakage due to use. Their durability is significantly lower compared to other tools that meet the standard 1-year warranty specifications, such as products with internal electronic components like multimeters and distance meters.



### PRODUCTS WITHOUT WARRANTY

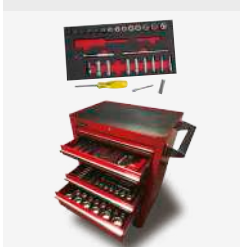
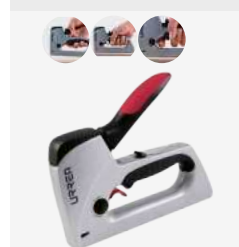

Non-sparking tools, impact sockets with tips, thin-wall impact sockets, thin-wall striking wrenches, adapters, and universal joints are made with special materials and designed for specific applications. Therefore, the warranty is only valid in case of manufacturing or material defects and if the tool shows no evidence of abuse, alteration, or overload. These items are not guaranteed against wear, fractures, or breakage due to normal use, as their resistance is significantly lower compared to other tools that meet standard specifications.

# PRODUCT HIGHLIGHTS AND INNOVATIONS

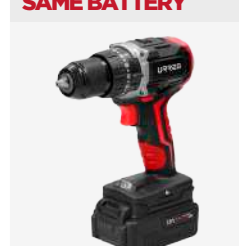
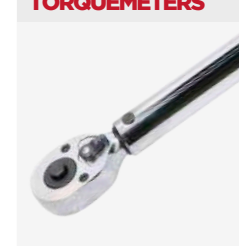
Always looking for improvement in its products, it has developed the following innovations.

2016	2017	2018	2019	2020
<b>CUSTOMIZED TRAYS FOR TOOLS</b> 	<b>STAPLER-NAILER</b> 	<b>CHOPPING AXES</b> 	<b>DUCTILE IRON PIPE WRENCHES</b> 	<b>MULTI-FUNCTIONAL CROSS WRENCH</b> 
URREA <small>GROUP ONLY APPROVED TOOL</small>	URREA <small>GROUP ONLY APPROVED TOOL</small>	URREA <small>GROUP ONLY APPROVED TOOL</small>	URREA <small>GROUP ONLY APPROVED TOOL</small>	URREA <small>GROUP ONLY APPROVED TOOL</small>

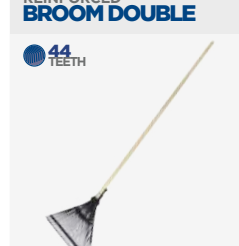
2021	2022	2023	2024	2025
<b>ERGONOMIC CLAMPS</b> 	<b>WIRELESS LINE SAME BATTERY</b> 	<b>THUNDER TORQUEMETERS</b> 	<b>URREA TOOL CABINET INDUSTRIAL USE</b> 	<b>20 V CORDLESS IMPACT WRENCHES</b> 
URREA <small>GROUP ONLY APPROVED TOOL</small>	URREA <small>GROUP ONLY APPROVED TOOL</small>	URREA <small>GROUP ONLY APPROVED TOOL</small>	URREA <small>GROUP ONLY APPROVED TOOL</small>	URREA <small>GROUP ONLY APPROVED TOOL</small>

2016	2017	2018	2019	2020
<b>ANTI SLIP HANDLES</b> 	<b>REINFORCED BROOM DOUBLE</b> 	<b>SUMERSIBLE WATER PUMP</b> 	<b>INVERTER WELDING MACHINE</b> 	<b>PLASTIC DRAWERS</b> 
SURTEK <small>TOOLS FOR SPECIALISTS</small>	SURTEK <small>TOOLS FOR SPECIALISTS</small>	SURTEK <small>TOOLS FOR SPECIALISTS</small>	SURTEK <small>TOOLS FOR SPECIALISTS</small>	SURTEK <small>TOOLS FOR SPECIALISTS</small>

2021	2022	2023	2024	2025
<b>SHOVELS WITH METAL HANDLE AND GRIP</b> 	<b>METAL WALL-MOUNTED HOSE HOLDER</b> 	<b>TOOL BOXEZ PLASTIC 100%</b> 	<b>SHOVELS WITH PLASTIC HANDLE AND FIT</b> 	<b>HOES WITH FIBERGLASS HANDLE</b> 
SURTEK <small>TOOLS FOR SPECIALISTS</small>	SURTEK <small>TOOLS FOR SPECIALISTS</small>	SURTEK <small>TOOLS FOR SPECIALISTS</small>	SURTEK <small>TOOLS FOR SPECIALISTS</small>	SURTEK <small>TOOLS FOR SPECIALISTS</small>





CLASS	TYPE	PAGE	BRAND	
			URREA	SURTEK
Industrial master tool sets	Master sets	24	•	
	Industrial intermediate sets	26	•	
	Industrial basic sets	28	•	
Specialty tool sets	Automotive tool sets	30	•	•
	Aviation tool sets	31	•	
	Tool sets for electrician and electronics	32	•	•
	Combination tool sets in case	33	•	
	Railway maintenance tool set	34	•	
	Combination tool sets	35	•	•
	Mechanic's tool set	35	•	•
	Measurement tool	39	•	
	Pneumatic tool set	39	•	
	Plumber tool sets	41	•	
	Tool set with modular organization	Modular organization tool sets	44	•
Trays for components		45	•	

[usa.urrea.com](http://usa.urrea.com)

We are constantly improving our products, that is why the information, characteristics and availability of them can change without prior notice.

## SYMBOLY

Organization and storage	Hand/impact sockets and accessories	Mechanical wrenches	Torque tools	Driver tools	Pliers, snips and cutters	Striking and struck tools	Pipe tools	Pullers	Vises and C-clamps	Automotive tools	Diagnostic and measuring tools	Cutting and grinding tools	Grease guns, oil and other fluids	Miscellaneous tools	Safety equipment	Marketing products

### INDUSTRIAL MASTER TOOL SETS

#### INDUSTRIAL MASTER TOOL SETS

HEAVY DUTY

INCHES METRIC

940 PIECES 99820

936 PIECES 99822

EX27M6 EX27M5 EX27S6



QR CODES

CONTENT

99820 99822

URREA

ITEM	PIECES	EX27M5	EX27M6	EX27S6																		AVAILABLE
99820	940	1	1	2	2	466	156	4	135	46	63	9	25	4	10	5	3	6	2	1	On Request	
99822	936	-	-	-	2	466	156	4	135	46	63	9	25	4	10	5	3	6	2	1	✓	

#### INDUSTRIAL MASTER TOOL SET WITHOUT CABINET

HEAVY DUTY

INCHES METRIC

787 PIECES



QR CODE

CONTENT

URREA

ITEM	PIECES																	AVAILABLE
99742	787	460	120	2	90	37	37	9	6	1	On Request							

For better storage of this sets we recommend URREA cabinets X41M11 and X41S8 or X27M7, X27I3 and X27S9

#### INDUSTRIAL MASTER TOOL SETS

HEAVY DUTY

INCHES METRIC

437 PIECES 99721

435 PIECES 99720

EX27M5 EX27S6



QR CODES

CONTENT

99721 99720

URREA

ITEM	PIECES	EX27M5	EX27S6																		AVAILABLE
99721	437	1	1	2	189	100	1	55	33	34	4	11	2	1	3	1	On Request				
99720	435	-	-	2	189	100	1	55	33	34	4	11	2	1	3	1	On Request				

INDUSTRIAL MASTER TOOL SETS

INDUSTRIAL MASTER TOOL SETS



**397**  
PIECES  
99622

**396**  
PIECES  
99621

**395**  
PIECES  
99620



CONTENT  
99622



CONTENT  
99621



CONTENT  
99620



MASTER TOOL SETS

ITEM	PIECES	EX27M5	EX27S6	EX27M6	📁	🗑️	🔧	🔩	🔪	🔨	🔩	🔩	🔩	🔩	🔩	🔩	🔩	🔩	AVAILABLE
99622	397	1	1	-	1	169	86	1	46	36	35	4	11	2	1	3	1	1	On Request
99621	396	-	-	1	1	169	86	1	46	36	35	4	11	2	1	3	1	1	On Request
99620	395	-	-	-	1	169	86	1	46	36	35	4	11	2	1	3	1	1	On Request

INDUSTRIAL MASTER TOOL SETS



**397**  
PIECES  
99521

**396**  
PIECES  
99520



CONTENT  
99521



CONTENT  
99520



ITEM	PIECES	EX27M6	📁	🗑️	🔧	🔩	🔪	🔨	🔩	🔩	🔩	🔩	🔩	🔩	🔩	🔩	🔩	🔩	AVAILABLE
99521	397	1	1	179	83	1	47	31	34	3	11	2	1	3	1	1	1	1	✓
99520	396	-	1	179	83	1	47	31	34	3	11	2	1	3	1	1	1	1	On Request

INDUSTRIAL MASTER TOOL SETS



**258**  
PIECES



CONTENT



ITEM	PIECES	📁	🗑️	🔧	🔩	🔪	🔨	🔩	🔩	🔩	🔩	🔩	🔩	🔩	🔩	🔩	🔩	AVAILABLE
99712B	258	3	124	43	1	29	26	13	4	10	1	1	3	1	1	1	1	On Request

For better storage of this sets we recommend URREA cabinets X27M7 or H27M6.

usa.urrea.com

**SUPERIOR**  
**Capability**

INDUSTRIAL MASTER TOOL SETS

## INTERMEDIATE INDUSTRIAL SETS

### INTERMEDIATE INDUSTRIAL TOOL SET

HEAVY DUTY INCHES METRIC

**234** PIECES



ITEM	PIECES																AVAILABLE	
997T2	234	1	109	42	1	20	8	31	1	5	7	1	3	1	2	2	1	On Request

For better storage of this sets we recommend URREA cabinet H41M12.

### INTERMEDIATE INDUSTRIAL TOOL SET

HEAVY DUTY INCHES METRIC

**186** PIECES



ITEM	PIECES																AVAILABLE
997T1	186	1	91	34	22	4	12	1	5	7	1	3	1	2	2	1	On Request

For better storage of this sets we recommend URREA cabinet H41M12.

### INTERMEDIATE INDUSTRIAL TOOL SET

HEAVY DUTY INCHES METRIC

**163** PIECES 99731B

**162** PIECES 99730

**EX27M6**



ITEM	PIECES	EX27M6															AVAILABLE
99731B	163	1	3	57	40	13	23	14	3	5	2	1	1	1	1	1	On Request
99730	162	-	3	57	40	13	23	14	3	5	2	1	1	1	1	1	✓

### IMPACT INTERMEDIATE INDUSTRIAL TOOL SET

HEAVY DUTY INCHES METRIC

**120** PIECES



ITEM	PIECES			AVAILABLE		
98152	120	114	5	1	1	On Request

For better storage of this sets we recommend URREA cabinets X30U5 or H27W3

INDUSTRIAL INTERMEDIATE SETS

SAE INDUSTRIAL MASTER TOOL SETS

HEAVY DUTY INCHES

216 PIECES 99512

215 PIECES 99510

EX27S6



QR CODES

CONTENT 99512

CONTENT 99510

URREA

ITEM	PIECES	EX27S6	📁	🗑️	🔧	🔪	🔗	🔨	🔩	⚙️	🔧	🔪	🔩	🔩	🔩	AVAILABLE
99512	216	1	3	94	38	33	21	14	1	5	2	1	3	1	On Request	
99510	215	-	3	94	38	33	21	14	1	5	2	1	3	1	On Request	

SAE INDUSTRIAL MASTER TOOL SETS

HEAVY DUTY INCHES

210 PIECES 99711A

209 PIECES 99710

EX27M6



QR CODES

CONTENT 99711A

CONTENT 99710

URREA

ITEM	PIECES	EX27M6	📁	🗑️	🔧	🔪	🔗	🔨	🔩	⚙️	🔧	🔪	🔩	🔩	🔩	AVAILABLE
99711A	210	1	4	92	41	1	19	24	14	4	6	2	1	1	1	On Request
99710	209	-	4	92	41	1	19	24	14	4	6	2	1	1	1	On Request

METRIC INDUSTRIAL MASTER TOOL SETS

HEAVY DUTY METRIC

202 PIECES 99552

201 PIECES 99550

EX27S6



QR CODES

CONTENT 99552

CONTENT 99550

URREA

ITEM	PIECES	EX27S6	📁	🗑️	🔧	🔪	🔗	🔨	🔩	⚙️	🔧	🔪	🔩	🔩	🔩	AVAILABLE
99552	202	1	1	102	40	19	15	15	1	5	1	1	3	1	On Request	
99550	201	-	0	102	40	19	15	15	1	5	1	1	3	1	On Request	

METRIC INDUSTRIAL MASTER TOOL SETS

HEAVY DUTY METRIC

155 PIECES 99431M

154 PIECES 99430M

EX27S6



QR CODES

CONTENT 99431M

CONTENT 99430M

URREA

ITEM	PIECES	EX27S6	📁	🗑️	🔧	🔪	🔗	🔨	🔩	⚙️	🔧	🔪	🔩	🔩	🔩	AVAILABLE
99431M	155	1	1	79	27	15	12	12	5	1	3	1	1	1	On Request	
99430M	154	-	1	79	27	15	12	12	5	1	3	1	1	1	✓	

## INDUSTRIAL BASIC TOOL SETS

### SAE INDUSTRIAL BASIC TOOL SET

**HEAVY DUTY** **INCHES** **II**

**124**  
PIECES



ITEM	PIECES										AVAILABLE
99500	124	3	62	17	15	9	12	5	1	1	On Request

For better storage of this sets we recommend URREA cabinets X27S9 or H27S6.

### SAE INDUSTRIAL BASIC TOOL SETS

**HEAVY DUTY** **INCHES** **II**

**86**  
PIECES  
99401

**85**  
PIECES  
99400

**D7**



ITEM	PIECES	D7									AVAILABLE
99401	86	1	2	39	17	8	6	12	1	1	✓
99400	85	-	2	39	17	8	6	12	1	1	On Request

### SAE INDUSTRIAL BASIC TOOL SETS

**HEAVY DUTY** **INCHES** **II**

**72**  
PIECES  
99301

**71**  
PIECES  
99300

**D7**



ITEM	PIECES	D7									AVAILABLE
99301	72	1	1	30	17	8	5	10	1	1	On Request
99300	71	-	1	30	17	8	5	10	1	1	On Request

### SAE INDUSTRIAL BASIC TOOL SETS

**HEAVY DUTY** **INCHES** **II**

**56**  
PIECES  
99201

**55**  
PIECES  
99200

**D6**



ITEM	PIECES	D6									AVAILABLE
99201	56	1	1	22	11	6	5	10	1	1	On Request
99200	55	-	1	22	11	6	5	10	1	1	✓

INDUSTRIAL BASIC TOOL SETS

SAE INDUSTRIAL BASIC TOOL SET FOR HEAVY-DUTY MAINTENANCE

HEAVY DUTY INCHES

**44** PIECES



ITEM	PIECES											AVAILABLE
98300	44		24		16		3		1		1	On Request

For better storage of this sets we recommend URREA cabinets X27M6 or H27M4.

METRIC INDUSTRIAL BASIC TOOL SET

HEAVY DUTY METRIC

**137** PIECES



ITEM	PIECES											AVAILABLE
99540M	137	4	69	17	8	14	12	10	1	3	1	On Request

For better storage of this sets we recommend URREA cabinets X27S9 or H27S6.

METRIC INDUSTRIAL BASIC TOOL SETS FOR HEAVY-DUTY MAINTENANCE

HEAVY DUTY METRIC

**98** PIECES 98322M

**97** PIECES 98320M

X27S9



ITEM	PIECES	X27S9										AVAILABLE
98322M	98	1		50	24	4	9	9	1	1	1	On Request
98320M	97			50	24	4	9	9	1	1	1	On Request

For better storage of this sets we recommend URREA cabinets X27S9 or H27S6

METRIC INDUSTRIAL BASIC TOOL SETS

HEAVY DUTY METRIC

**68** PIECES 99211M

**67** PIECES 99210M

CPU20A



ITEM	PIECES	CPU20A										AVAILABLE
99211M	68	1	1	28	11	6	8	10	1	2	1	On Request
99210M	67	-	1	28	11	6	8	10	1	2	1	✓

## AUTOMOTIVE COMBINATION TOOL SETS

### AUTOMOTIVE COMBINATION TOOL SET, FOR OIL CHANGE

HEAVY DUTY INCHES METRIC

**73**  
PIECES



ITEM	PIECES									AVAILABLE
98051	73	29	20	10	3	4	1	6	1	✓

### AUTOMOTIVE COMBINATION TOOL SETS, FOR MAINTENANCE

HEAVY DUTY INCHES METRIC

**71**  
PIECES  
9910

**70**  
PIECES  
9911



9910



9911



ITEM	PIECES	D6									AVAILABLE
9910	71	1	25	26	5	4	7	1	2	1	On Request
9911	70	-	25	26	5	4	7	1	2	1	On Request

### AUTOMOTIVE COMBINATION TOOL SET, FOR TRANSMISSION REPAIR

HEAVY DUTY INCHES METRIC

**58**  
PIECES



ITEM	PIECES	D3									AVAILABLE
98052	58	1	37	11	1	6	2	1	1	✓	

### SAE AUTOMOTIVE MASTER TOOL SETS

HEAVY DUTY INCHES

**137**  
PIECES  
9906

**136**  
PIECES  
9907

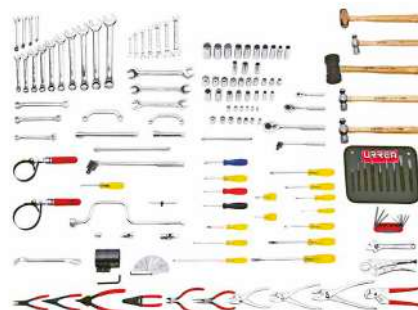

9906



9907



ITEM	PIECES	9992									AVAILABLE
9906	137	1	59	30	17	11	14	5	1	On Request	
9907	136	-	59	30	17	11	14	5	1	On Request	



**AUTOMOTIVE COMBINATION TOOL SETS**

**METRIC AUTOMOTIVE MASTER TOOL SETS**



**143**  
PIECES  
9906M

**142**  
PIECES  
9907M



9992

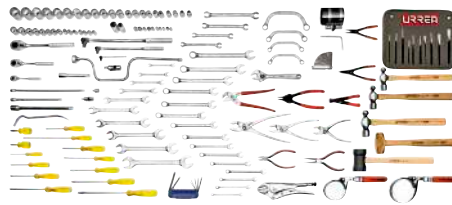

CONTENT  
9906M



CONTENT  
9907M

URREA



CONTENT  
9906M

CONTENT  
9907M



ITEM	PIECES	9992										AVAILABLE
9906M	143	1	64	34	13	11	15	5	1			On Request
9907M	142	-	64	34	13	11	15	5	1			On Request

**SAE AUTOMOTIVE STARTER TOOL SETS**



**54**  
PIECES  
9915



URREA



ITEM	PIECES	D6									AVAILABLE
9915	54	27		10	6	2	7	2	1		On Request

**METRIC AUTOMOTIVE STARTER TOOL SETS**



**58**  
PIECES  
9914M

**57**  
PIECES  
9915M

**58**  
PIECES  
9914M

**57**  
PIECES  
9915M



D6



URREA



CONTENT  
9914M



CONTENT  
9915M



ITEM	PIECES	D6									AVAILABLE
9914M	58	1	26	15	6	6	2	1			On Request
9915M	57	-	26	15	6	6	2	1			On Request

**PORTABLE USB PORT JUMP STARTER SET**

PROFESSIONAL USE LED WORK LIGHT 1 USB PORT

**6 000 mAh**  
BATTERY CAPACITY

**200 A**  
START

Content  
6,000 mAh battery starter 1  
battery terminal cleaner 1  
Small multipurpose case 1



SURTEK



CONTENT  
JA3



ITEM	PIECES	D6	AVAILABLE
JA3	3	1	On Request

**AVIATION INDUSTRIAL SETS**

**SAE INDUSTRIAL AVIATION TOOL SETS**



**70**  
PIECES  
98241

**69**  
PIECES  
98240

D6



CONTENT  
98241



CONTENT  
98240

URREA



CONTENT  
98241

CONTENT  
98240



ITEM	PIECES	D6									AVAILABLE
98241	70	1	1	24	9	20	7	8	1		On Request
98240	69	-	1	24	9	20	7	8	1		On Request

## TOOL SETS IN TOOL POUCH OR TOTE

### SAE BASIC INDUSTRIAL ELECTRICIAN TOOL SET WITH METAL BOX



INCHES



**65**  
PIECES



URREA



NEW



ITEM	PIECES	D7C20										AVAILABLE
98166	65	1	12	36	7	2	1	3	2	1	1	✓

### COMBINATION ELECTRICIAN TOOL SET WITH BACKPACK



**31**  
PIECES



URREA



NEW



ITEM	PIECES										AVAILABLE
JMH05	31	1	1	16	5	1	4	3	1	1	✓

### ELECTRICIAN TOOL SET WITH 4 POCKET POLYESTER POUCH



**11**  
PIECES



URREA



ITEM	PIECES	BN140					AVAILABLE
JE11	11	1	4	5	1	1	✓

### COMBINATION ELECTRICIAN TOOL SET 1000 V



**6**  
PIECES



Content	
Tool pouch 6 pockets leather	1
1000 V plier 8" universal	1
1000 V plier 8" long nose	1
Yellow screwdriver phillips 1000 V #2 x 4"	1
Yellow screwdriver cabinet 1000 V 1/4" x 6"	1
Voltage tester non-contact 90 V to 1000 V	1

ITEM	PIECES	AVAILABLE
JE6A	6	1 On Request

SURTEK



CONTENT



VIDEO



### COMBINATION ELECTRICIAN TOOL SET



**6**  
PIECES



Content	
Mini side cutting pliers 4-3/4"	1
Mini electrician's pliers 4-1/2"	1
Mini bent nose pliers 4-3/4"	1
Mini diagonal cutting pliers 4-5/16"	1
Mini round nose pliers 4-3/4"	1
Small multi-purpose pouch	1

ITEM	PIECES	AVAILABLE
JE6	6	1 On Request

SURTEK



CONTENT



VIDEO



TOOL SETS IN TOOL POUCH OR TOTE

BASIC TOOL SAMPLER SET WITH CARRYING CASE



30  
PIECES



ITEM	PIECES	PTR10									AVAILABLE
10A	30	•	1	8	5	4	3	1	1	1	✓

INNOVATION TOOL SAMPLER SET WITH CARRYING CASE



27  
PIECES



ITEM	PIECES	PTR10										AVAILABLE
10B	27	•	10	7	1	3	1	1	1	1	1	✓

BASIC TOOL SET WITH CARRYING CASE



10  
PIECES



ITEM	PIECES	PTR2						AVAILABLE
7A	10	•	4	2	3	1	1	✓

BASIC TOOL SET WITH BIMATERIAL HANDLES



9  
PIECES



ITEM	PIECES	PTR2					AVAILABLE
7B	9	•	4	2	3	1	✓

## SAE INDUSTRIAL RAILROAD MAINTENANCE TOOL SETS

### SAE INDUSTRIAL RAILROAD MAINTENANCE TOOL SET

HEAVY DUTY INCHES

**135**  
PIECES



D7



ITEM	PIECES	D7										AVAILABLE
98101	135	1	61	33	8	10	17	2	1	2	1	On Request

### SAE INDUSTRIAL RAILROAD MAINTENANCE TOOL SET

HEAVY DUTY INCHES

**102**  
PIECES



D7



ITEM	PIECES	D7										AVAILABLE
98111	102	1	60	18	5	2	6	10	1			On Request

### SAE INDUSTRIAL RAILROAD MAINTENANCE TOOL SET

HEAVY DUTY INCHES

**78**  
PIECES



D7



ITEM	PIECES	D7										AVAILABLE
98131	78	1	28	1	8	25	6	5	2	1		On Request

### SAE INDUSTRIAL RAILROAD MAINTENANCE TOOL SET

HEAVY DUTY INCHES

**68**  
PIECES



D7



ITEM	PIECES	D7										AVAILABLE
98121	68	1	28	18	6	4	8	1	2	1		✓

TOOL SETS

COMBINATION TOOL SET IN BLOW MOLDED CASE

PROFESSIONAL USE F4458A INCHES  
F4458AM METRIC

70 PIECES

Common content for both sets

1/4" & 1/2" Drive ratchets	2
1/4" x 3" & 1/2" x 5" extensions	2
1/4" Square drive screwdriver	1
1/4" & 1/2" Universal joint	2
13/16" & 5/8" Spark plug sockets	2
8oz ball-pein hammer	1
10" Locking plier	1
8" Pipe plier	1
7" Linesmen plier	1
Ph2 phillips stubby screwdriver	1
1/4" Slotted stubby screwdriver	1
1/4" x 4" phillips screwdriver	1
1/4" x 4" & 5/16" x 8" slotted screwdrivers	2
Phillips® bits	3
Slotted bits: 3 mm, 4 mm, 5 mm, 6 mm y 7 mm	5
Hex bits 2 mm, 2.5 mm, 3 mm y 5 mm	4
Ton® bits	2
L-bit	1
Bit adaptor	1

**Content - F4458A -**

1/4" Drive sockets (5/32" to 1/2")	10
1/4" Drive deep sockets (5/16" to 9/16")	5
1/2" Drive sockets (3/8" to 1-1/8")	13
5/16" To 3/4" combination wrenches	8

**Content - F4458AM -**

1/4" Drive sockets (4 - 13 mm)	10
1/4" Drive deep sockets (Ø - 14 mm)	5
1/2" Drive sockets (10 - 32 mm)	13
9 - 19 mm combination wrenches	8



ITEM	PIECES	📦	AVAILABLE
F4458A	70	1	✓
F4458AM	70	1	✓

COMBINATION TOOL SET IN BLOW MOLDED CASE

PROFESSIONAL USE F4458 INCHES  
F4458M METRIC

50 PIECES

Common content for both sets

1/4" & 1/2" Ratchets	2
1/4" x 3", 1/2" x 5" & 1/2" x 10" extensions	3
1/4" Hex bit screwdriver	1
1/4" & 1/2" Universal joint	2
13/16" Spark plug socket	1
1/4" & 1/2" Sliding t-handle	2
Phillips® bits: ph1, ph2, ph3	3
Slotted bits: 4, 5, 6 and 7 mm	4
Hex bits: 2, 2.5 And 3 mm	3
Ton® bits: t10, t15 and t20	3
L-bit	1
Couple	1
1/4" Bit adaptor	1

**Content - F4458 -**

1/4" Drive sockets: 5/32" to 1/2"	10
1/2" Drive sockets: 3/8" to 1-1/4"	13

**Content - F4458A -**

1/4" Drive sockets: 4 to 13 mm	10
1/2" Drive sockets: 10 - 30 mm	13



ITEM	PIECES	📦	AVAILABLE
F4458	50	1	On Request
F4458M	50	1	✓

TOOL SETS FOR MECHANICS

COMBINATION MECHANIC TOOL SET WITH PLASTIC CASE

INDUSTRIAL DUTY INCHES  
METRIC

12 8 6 12 6

450 PIECES



NEW

ITEM	PIECES	📦	🔩	🔧	🔪	🔧	🔪	📦	AVAILABLE
JCB01	450	Plastic case	191	16	56	187	1	1	On Request

## TOOL SETS FOR MECHANIC

### COMBINATION MECHANIC TOOL SET WITH PLASTIC CASE

INDUSTRIAL DUTY

INCHES METRIC

1/4" 3/8" 1/2"

12 6 12 6

**230** PIECES



ITEM	PIECES	Case	Socket	Wrench	Screwdriver	Other	Availability
JCB02	230	Plastic case	116	7	46	61	1 AVAILABLE On Request

### 1/4" AND 3/8" COMBINATION SOCKET AND ACCESSORIES SET, IN METALLIC TOOL BOX

INDUSTRIAL DUTY

INCHES METRIC

1/4" 3/8" 12 12

**178** PIECES



ITEM	PIECES	Case	Socket	Wrench	Screwdriver	Other	Availability
JCM01	178	Metal box	45	4	4	9 116	1 AVAILABLE ✓

### COMBINATION TOOL SET WITH PLASTIC CASE

HEAVY DUTY

INCHES METRIC

1/4" 3/8" 1/2"

12 6 12 6

**170** PIECES



ITEM	PIECES	Case	Socket	Wrench	Screwdriver	Other	Availability
JCB03	170	Plastic case	91	7	12	60	1 AVAILABLE ✓

### 1/4" AND 3/8" COMBINATION SOCKET AND ACCESSORIES SET, IN METALLIC TOOL BOX

INDUSTRIAL DUTY

INCHES METRIC

1/4" 3/8" 12 12

**130** PIECES



ITEM	PIECES	Case	Socket	Wrench	Screwdriver	Other	Availability
JCM02	130	Metal box	46	4	5	75	1 AVAILABLE On Request

TOOL SETS FOR MECHANIC

COMBINATION MECHANIC TOOL SET WITH BACKPACK



102  
PIECES



ITEM	PIECES													AVAILABLE
JMH02	102	1	66	17	7	6	6	6	1	1	1	1	1	✓

SAE BASIC INDUSTRIAL MECHANIC TOOL SET WITH METAL BOX



93  
PIECES



ITEM	PIECES	D7C20												AVAILABLE
98165	93	1	20	17	28	4	11	1	4	2	3	2	1	✓

COMBINATION TOOL SET WITH BACKPACK



39  
PIECES



ITEM	PIECES													AVAILABLE
JMH01	39	1	15	9	5	2	1	3	2	1	1	1	1	✓

COMBINATION MECHANIC TOOL SET WITH PLASTIC CASE



214  
PIECES



ITEM	PIECES												AVAILABLE
JCM1S	214	Plastic case	103	16	12	9	74	1	1	1	1	1	✓

## TOOL SETS FOR MECHANIC

### COMBINATION MECHANIC TOOL SET WITH PLASTIC CASE

PROFESSIONAL USE **INCHES** **METRIC**

1/2" 3/4" 9/16" 1/4"

6 12 12

**169**  
PIECES



**SURTEK**  
TOOLS FOR SPECIALISTS



**NEW**



ITEM	PIECES								AVAILABLE
JCM2S	169	Plastic case	102	15	8		44	1	✓

### COMBINATION MECHANIC TOOL SET WITH PLASTIC CASE

PROFESSIONAL USE **INCHES** **METRIC**

**107**  
PIECES

Content		Content	
1/4" square drive screwdriver	1	1/4" square drive screwdriver	1
6-point sockets, 1/2" drive (from 1/2" to 3/4")	4	3/8" spark plug sockets	2
6-point sockets, 1/2" drive (from 13 mm to 19 mm)	7	Flat bits (sizes 5-6 to 10-12)	4
Long 6-point sockets, 1/2" drive (from 1/2" to 3/4")	4	Phillips® bits (from PH0 to PH3)	11
Long 6-point sockets, 1/2" drive (from 13 mm to 19 mm)	6	Pozidriv® bits (from PZ0 to PZ3)	4
12-point sockets, 3/8" drive (from 3/8" to 5/8")	5	Hex bits (from 3/32" to 1/4")	6
12-point sockets, 3/8" drive (from 9 mm to 19 mm)	8	Torx® bits (from T10 to T40)	6
Standard combination wrenches (from 1/4" to 15/16")	8	Square bits (from S1 to S3)	3
Metric combination wrenches (from 7 mm to 15 mm)	8	Standard hex keys (from 1/16" to 1/4")	7
Ratchets (3/8" and 1/2" drive)	2	Metric hex keys (from 1.5 mm to 6 mm)	7
Extensions (3/8" x 3", 1/2" x 2-1/2", and 1/2" x 5")	3	Metal box	1



**SURTEK**  
TOOLS FOR SPECIALISTS



**NEW**



ITEM	PIECES								AVAILABLE	
125412	107	Metal box	34	6	16	14	34	2	1	✓

### COMBINATION MECHANIC TOOL SET WITH PLASTIC CASE

PROFESSIONAL USE **INCHES** **METRIC**

1/2" 3/4" 1/4"

6 12 12

**106**  
PIECES



**SURTEK**  
TOOLS FOR SPECIALISTS



**NEW**



ITEM	PIECES								AVAILABLE
JCM3S	106	Plastic case	74	11	4		17	1	✓

### COMBINATION MECHANIC TOOL SET WITH PLASTIC CASE

PROFESSIONAL USE **INCHES** **METRIC**

1/2" 3/4" 1/4"

6 12 12 C

**84**  
PIECES



**SURTEK**  
TOOLS FOR SPECIALISTS



**NEW**



ITEM	PIECES								AVAILABLE
JCM4S	84	Plastic case	43	13	10	1	17	1	✓



COMBINATION PROFESSIONAL MEASURING TOOL SET

COMBINATION PROFESSIONAL MEASURING TOOL SET



5 PIECES

Content	
Waterproof case 20.5"	1
Semi-auto laser level, 2 lines	1
Laser square level, 2 lines	1
Tripod 51.2" for laser level	1
9" torpedo level	1



NEW



ITEM	PIECES	AVAILABLE
JMP5	5	On Request



SUPERIOR Impact



1/2" COMPOSITE IMPACT WRENCH TWIN HAMMER SYSTEM AND SAE SOCKET SET

usa.urrea.com

AIR IMPACT WRENCHES SETS

1/2" COMPOSITE IMPACT WRENCH TWIN HAMMER SYSTEM AND SAE SOCKET SET



INCHES



13 PIECES

Item	Size
7412H	3/8"
7414H	7/16"
7416H	1/2"
7418H	9/16"
7420H	5/8"
7422H	11/16"
7424H	3/4"
7426H	13/16"
7428H	7/8"
7430H	15/16"

Content	
Accessories	
PC731A	1/2" impact wrench
7181P	1/2 x 5" extension
CPUC20	21" compact box



ITEM	PIECES	AVAILABLE
UPC731K	13	✓

1/2" COMPOSITE IMPACT WRENCH TWIN HAMMER SYSTEM AND METRIC SOCKET SET



METRIC



13 PIECES

Item	Size
7410M	10 mm
7412M	12 mm
7413M	13 mm
7414M	14 mm
7415M	15 mm
7416M	16 mm
7417M	17 mm
7418M	18 mm
7419M	19 mm
7421M	21 mm

Content	
Accessories	
PC731A	1/2" impact wrench
7181P	1/2 x 5" extension
CPUC20	21" compact box



ITEM	PIECES	AVAILABLE
UPC731KM	13	✓

1/2" IMPACT WRENCH TWIN HAMMER SYSTEM AND SAE SOCKET SET



INCHES



13 PIECES

Item	Size
7412H	3/8"
7414H	7/16"
7416H	1/2"
7418H	9/16"
7420H	5/8"
7422H	11/16"
7424H	3/4"
7426H	13/16"
7428H	7/8"
7430H	15/16"

Content	
Accessories	
7181P	5" extension
P731B	1/2" impact wrench
CPUC20	21" compact box



ITEM	PIECES	AVAILABLE
UP731K	13	On Request

1/2" IMPACT WRENCH TWIN HAMMER SYSTEM AND METRIC SOCKET SET



METRIC



13 PIECES

Item	Size
7410M	10 mm
7412M	12 mm
7413M	13 mm
7414M	14 mm
7415M	15 mm
7416M	16 mm
7417M	17 mm
7418M	18 mm
7419M	19 mm
7421M	21 mm

Content	
Accessories	
7181P	5" extension
P731B	1/2" impact wrench
CPUC20	21" compact box



ITEM	PIECES	AVAILABLE
UP731KM	13	✓

1/2" IMPACT WRENCH PIN CLUTCH SYSTEM AND SAE SOCKET SET



INCHES



13 PIECES

Item	Size
7412H	3/8"
7414H	7/16"
7416H	1/2"
7418H	9/16"
7420H	5/8"
7422H	11/16"
7424H	3/4"
7426H	13/16"
7428H	7/8"
7430H	15/16"

Content	
Accessories	
7181P	5" extension
P734HA	1/2" impact wrench
CPUC20	21" compact box



ITEM	PIECES	AVAILABLE
UP734HK	13	✓

1/2" IMPACT WRENCH PIN CLUTCH SYSTEM AND METRIC SOCKET SET



METRIC



13 PIECES

Item	Size
7410M	10 mm
7412M	12 mm
7413M	13 mm
7414M	14 mm
7415M	15 mm
7416M	16 mm
7417M	17 mm
7418M	18 mm
7419M	19 mm
7421M	21 mm

Content	
Accessories	
7181P	5" extension
P734HA	1/2" impact wrench
CPUC20	21" compact box



ITEM	PIECES	AVAILABLE
UP734HKM	13	✓

## AIR IMPACT WRENCHES SETS

### 1/2" IMPACT WRENCH TWIN HAMMER SYSTEM AND SAE SOCKET SET

**HEAVY DUTY** INCHES 1/2" 6

**7** PIECES



Content	
Item	Size
7416H	1/2"
7420H	5/8"
7424H	3/4"
7428H	7/8"
7430H	15/16"

Content	
Accessories	
P731C	1/2" impact wrench
CPUC20	21" compact box



ITEM	PIECES	☐	AVAILABLE
UP731AK	7	1	✓

### 1/2" IMPACT WRENCH PIN CLUTCH SYSTEM AND METRIC SOCKET SET

**HEAVY DUTY** METRIC 1/2" 6

**7** PIECES



Content	
Item	Size
7414M	14 mm
7416M	16 mm
7417M	17 mm
7419M	19 mm
7422M	22 mm

Content	
Accessories	
P731C	1/2" impact wrench
CPUC20	21" compact box



ITEM	PIECES	☐	AVAILABLE
UP731AKM	7	1	✓

### 3/4" IMPACT WRENCH TWIN HAMMER SYSTEM AND SAE SOCKET SET

**SUPER DUTY** INCHES 3/4" 6

**10** PIECES



Content	
Item	Size
7512	3/4"
7513	13/16"
7515	15/16"
7516	1"
7517	1-1/16"
7518	1-1/8"
7519	1-3/16"
7520	1-1/4"

Content	
Accessories	
P776A	3/4" impact wrench
CPUC20	21" compact box



ITEM	PIECES	☐	AVAILABLE
UP776K	10	1	✓

### 3/4" IMPACT WRENCH PIN CLUTCH SYSTEM AND METRIC SOCKET SET

**SUPER DUTY** METRIC 3/4" 6

**10** PIECES



Content	
Item	Size
7519M	19 mm
7521M	21 mm
7524M	24 mm
7525M	25 mm
7527M	27 mm
7529M	29 mm
7530M	30 mm
7532M	32 mm

Content	
Accessories	
P776A	3/4" impact wrench
CPUC20	21" compact box



ITEM	PIECES	☐	AVAILABLE
UP776KM	10	1	✓

### 3/4" COMPOSITE IMPACT WRENCH TWIN HAMMER SYSTEM AND SAE SOCKET SET

**SUPER DUTY** INCHES 3/4" 6

**10** PIECES



Content	
Item	Size
7512	3/4"
7513	13/16"
7515	15/16"
7516	1"
7517	1-1/16"
7518	1-1/8"
7519	1-3/16"
7520	1-1/4"

Content	
Accessories	
PC776A	3/4" impact wrench
CPUC20	21" compact box



ITEM	PIECES	☐	AVAILABLE
UPC776K	10	1	✓

### 3/4" COMPOSITE IMPACT WRENCH TWIN HAMMER SYSTEM AND METRIC SOCKET SET

**SUPER DUTY** METRIC 3/4" 6

**10** PIECES



Content	
Item	Size
7519M	19 mm
7521M	21 mm
7524M	24 mm
7525M	25 mm
7527M	27 mm
7529M	29 mm
7530M	30 mm
7532M	32 mm

Content	
Accessories	
PC776A	3/4" impact wrench
CPUC20	21" compact box



ITEM	PIECES	☐	AVAILABLE
UPC776KM	10	1	✓

AIR IMPACT WRENCHES SETS

3/4" IMPACT WRENCH TWIN HAMMER SYSTEM AND SAE SOCKET SET



INCHES



10  
PIECES

Item	Size
7512	3/4"
7513	13/16"
7515	15/16"
7516	1"
7517	1 1/16"
7518	1 1/8"
7519	1 3/16"
7520	1 1/4"

Content	
Accessories	
P772HB	3/4" impact wrench
CPUC20	21" compact box



ITEM	PIECES	📦	AVAILABLE
UP772HK	10	1	✓

3/4" IMPACT WRENCH TWIN HAMMER SYSTEM AND METRIC SOCKET SET



METRIC



10  
PIECES

Item	Size
7519M	19 mm
7521M	21 mm
7524M	24 mm
7525M	25 mm
7527M	27 mm
7529M	29 mm
7530M	30 mm
7532M	32 mm

Content	
Accessories	
P772HB	3/4" impact wrench
CPUC20	21" compact box



ITEM	PIECES	📦	AVAILABLE
UP772HKM	10	1	✓

3/4" IMPACT WRENCH TWIN HAMMER SYSTEM AND SAE SOCKET SET



INCHES



7  
PIECES

Item	Size
7514	7/8"
7515	15/16"
7516	1"
7517	1-1/16"
7518	1-1/8"

Content	
Accessories	
PC776A	3/4" impact wrench
CPUC20	21" compact box



ITEM	PIECES	📦	AVAILABLE
UP772HAK	7	1	On Request

3/4" IMPACT WRENCH TWIN HAMMER SYSTEM AND METRIC SOCKET SET



METRIC



7  
PIECES

Item	Size
7524M	24 mm
7527M	27 mm
7530M	30 mm
7532M	32 mm
7536M	36 mm

Content	
Accessories	
PC776A	3/4" impact wrench
CPUC20	21" compact box



ITEM	PIECES	📦	AVAILABLE
UP772HAKM	7	1	✓

COMBINATION TOOL SET FOR PLUMBER

COMBINATION TOOL SET FOR PLUMBER WITH CARRYING CASE



25  
PIECES



CONTENT



NEW



ITEM	PIECES	📦	🔧	🔪	✂️	🔩	🔌	🌀	🔬	📦	AVAILABLE
JPH04	25	1	2	9	2	6	4	3	2	1	✓

## TRAY FOR COMPONENTS

Urrea offers **4 ways** to customize the **organization of your tools**, using trays that are made of EVA foam with cut-outs for each tool.

### 01 MODULAR ORGANIZATION SYSTEM

- 95 different kits.
- 3 sizes of trays are available, which can be adapted to multiple working areas. Urrea 27" cabinets can be equipped as required with 1/3, 2/3 or 3/3 trays.
- Immediate availability.
- More than 17,000 different combinations of tools sets can be configured by drawer.

Recommended for users who can meet their needs with our available sets and require immediate solution.

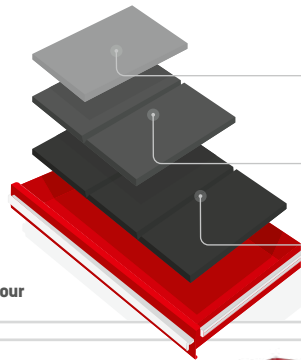

**SMALL TRAY**



7" x 14"  
(1/3 of 27"  
cabinet's drawer)

**MEDIUM TRAY**



14" x 14"  
(2/3 of 27"  
cabinet's drawer)

**LARGE TRAY**



21" x 14"  
(one 27"  
cabinet's  
drawer)

Follow these steps to order:

1. Check available sets in our valid price list or at: [www.urreaprofessionaltools.com](http://www.urreaprofessionaltools.com)
2. Contact an authorized distributor to get the price.
3. Order the selected sets.
4. Soon you will receive your sets.

### 02 TRAY CUSTOMIZATION WITH URREA TOOLS

Urrea helps you to create a new set that includes:

- Your selected Urrea tools.
- Customized one or more cabinets (can be optional).
- EVA foam trays.

Recommended where there are some users with same or similar functions and require the same tool content (example: auto workshop, production lines, etc).



Follow these steps to order:

1. Ask your Urrea Customer Service Representative (UCSR) for our "TRAY CUSTOMIZATION FORM".
2. Select the tool cabinet or area where tools will be stored.
3. Select the item No. required.
4. Send TRAY CUSTOMIZATION FORM to your Urrea customer service representative to receive quotation and shipment date within 48 hours.
5. Review and approve quotation and confirm your purchase order to your UCSR.
6. In maximum 10 working days you will receive the design for your approval and we will define the delivery time.
7. You will receive your sets at the defined delivery date.

CONDITIONS:

- Minimum order quantity: 1 set
- No cancellations or returns allowed once design is accepted by distributor and purchase order has been confirmed.
- Tray designs for Urrea tools only.

### 03 TRAY CUSTOMIZATION WITHOUT TOOLS

Urrea offers the service of customization only the trays to accommodate your Urrea tools, we adapt the trays to fit your cabinets.

Recommended for users who already have URREA tools and needs a better way to organize them avoiding additional investment.

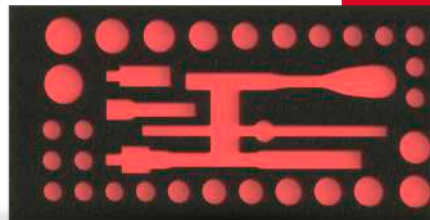

Follow these steps to order:

1. Ask your Urrea customer service representative (UCSR) for our "TRAY CUSTOMIZATION FORM".
2. Indicate the tool cabinet or area where tools will be stored.
3. Indicate the item No. which you intend to accommodate.
4. Send TRAY CUSTOMIZATION FORM to your Urrea customer service representative to receive quotation and shipment date within 48 hours.
5. Review and approve quotation and confirm your Purchase Order to your UCSR.
6. In maximum 10 working days you will receive the design for your approval and we will define the delivery time.
7. You will receive your sets at the defined delivery date.

CONDITIONS:

- Minimum order quantity: 1 tray.
- No cancellations or returns allowed once design is accepted by distributor and purchase order has been confirmed.
- Tray designs for Urrea tools only.

### 04 TRAY CUSTOMIZATION WITH TOOLS AND LASER MARKING

It is a combination of custom sets in EVA foam trays plus personalization of laser engraving on tools.



Follow these steps to order:

1. Ask your Urrea customer service representative (UCSR) for our TRAY CUSTOMIZATION FORM
2. Indicate the tool cabinet or area where tools will be stored. Indicate the item No. which you intend to accommodate and de logo or text to engrave.
3. Send TRAY CUSTOMIZATION FORM to your Urrea customer service representative to receive quotation and shipment date.
4. Review and approve quotation and confirm your Purchase Order to your UCSR.

CONDITIONS:

- Minimum order quantity: 1 tray.
- No cancellations or returns allowed.
- once design is accepted by distributor and purchase order has been confirmed.
- Tray designs for Urrea tools only.

## TRAY FEATURES



EVA foam  
Resist tears, strains  
and most chemicals



0.70" and 1.18" in  
thickness



Exact profile  
of your tools



Double  
color tray



Laminated tray  
(optional)



Etching  
size in tray

## BENEFITS



Organized tools  
for the job



Identify  
misplaced tools



Protect tools  
of contact friction

usa.urrea.com • customerservice@urrea.com • 7042 Industrial Way, suite 135 San Antonio, TX, 78252. Fax: (210) 734-8715. Phone: (800) 366-6911.

MODULAR ORGANIZATION SYSTEM



## MODULAR ORGANIZATION SYSTEM

### WHAT IS IT?

It is a tool organization system based in trays **made of EVA foam** that have specific inlays for each kind of tool.

**3 sizes of trays** are available, which can be adapted to multiple work spaces. Urrea 27" cabinets can be equipped as required with 1/3, 2/3 or 3/3 trays. Sizes available are:

<b>SMALL TRAY</b>	<b>S</b>	7" x 14" (1/3 of 27" cabinet's drawer)
<b>MEDIUM TRAY</b>	<b>M</b>	14" x 14" (2/3 of 27" cabinet's drawer)
<b>LARGE TRAY</b>	<b>L</b>	21" x 14" (one 27" cabinet's drawer)

### BENEFITS:

High level of control, organization and security, protects high-grade, expensive tools from damage and is ideal wherever large numbers of tools are prone to "disappear".

Each tool has a defined position, ensuring:

- Have only the necessary tools.
- Find easily and quickly the required tool.
- Identify missing or misplaced tools.
- Protect tools from constant friction.

Build cabinet drawer's with more than 17,000 different combinations of tool sets. It gives great flexibility when assembling your own cabinet as needed.

### ADVANTAGES OF THE TRAY:

1. The inlays are made of EVA foam that are chemical-resistant and extremely flexible.
2. The sculpted cut-outs enable you to see at a glance each tools position.
3. The sculpted cut-outs for each tool are individually shaped using CNC technology to provide each tool with a secure place.
4. Easy to remove thanks to different additional recesses.

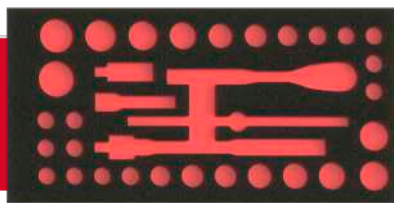
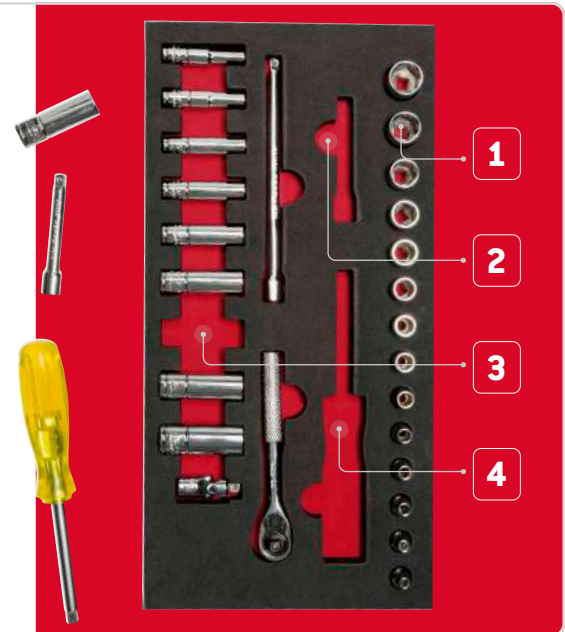

### EVA - EVA OPTION

Its a 0.63" (16 mm) 2-layer EVA foam tray. First layer is 0.24" (6 mm) red color and second layer is 0.39" (10 mm) black color. For sets CH301, CH308, CH220, CH309 and CH223, the tray's thickness is 26 mm to prevent tools move their position.

Product's size is engraved on each product's position for easy identification. EVA foam resists scratches, chemicals and other industrial solvents.

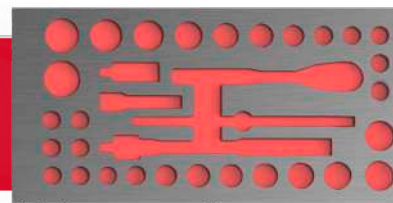

### EVA - LAMINATED PLASTIC COVER OPTION

Same EVA – EVA tray reinforced with a 0.06" (1.6 mm) laminated plastic cover that brings more durability and resistance, mainly to blows.

Product's size is engraved on each product's position for easy identification.

Easy to clean.

Rounded edges to prevent injuries.

## INDUSTRIAL SETS WITH MODULAR ORGANIZATION SYSTEM

### INDUSTRIAL SET WITH 7 DRAWER MODULAR ORGANIZATION SYSTEM



**194**  
PIECES



EX27M7



CH308

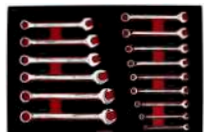

CH304



CH212



CH307



CH303



CH223



CH203



CH114



CH104



CH120

URREA



CONTENT



ITEM	PIECES										AVAILABLE
J1194	194	1	76	46	48	7	5	3	8	1	On Request

### INDUSTRIAL SET WITH 6 DRAWER MODULAR ORGANIZATION SYSTEM



**112**  
PIECES



EX27M6



CH308

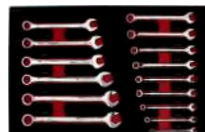

CH304



CH127



CH309



CH303



CH130



CH115



CH122



CH120



CH126

URREA



CONTENT



ITEM	PIECES									AVAILABLE
J1112	112	1	75	6	13	13	5	1	1	On Request

### INDUSTRIAL SET WITH 3 DRAWER MODULAR ORGANIZATION SYSTEM



**50**  
PIECES



I27M3



CH308



CH211



CH126



CH130



CH115



CH127

URREA



CONTENT



ITEM	PIECES						AVAILABLE
J150	50	1	6	13	31	1	On Request

TRAY FOR COMPONENTS

LARGE TRAY FOR COMPONENTS

HEAVY DUTY EVA COVER L LARGE TRAY

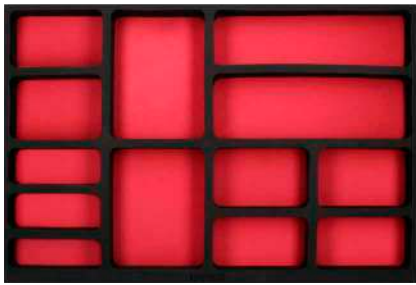

ITEM	DIVISIONS	LENGTH	WIDTH	THICKNESS	AVAILABILITY
BAG3	13	550 mm	360 mm	30 mm	1 On Request

SMALL TRAY FOR COMPONENTS

HEAVY DUTY EVA COVER S SMALL TRAY



ITEM	DIVISIONS	LENGTH	WIDTH	THICKNESS	AVAILABILITY
BAC5	10	360 mm	180 mm	54 mm	1 On Request

SMALL TRAY FOR COMPONENTS

HEAVY DUTY EVA COVER S SMALL TRAY



ITEM	DIVISIONS	LENGTH	WIDTH	THICKNESS	AVAILABILITY
BAC3	10	360 mm	180 mm	30 mm	1 On Request

1/4" DRIVE SOCKET SETS WITH ACCESSORIES WITH EVA TRAY

1/4" DRIVE SHORT SOCKET SET WITH ACCESSORIES SAE AND METRIC 6 POINT

HEAVY DUTY 1/4" 6 6

EVA COVER S SMALL TRAY

31 PIECES



CONTENT



ITEM	PIECES	DESCRIPTION	AVAILABILITY
CH101	31	Socket set with accessories	1 ✓
CH101-C	1	EVA	1 On Request

1/4" DRIVE SHORT AND DEEP SOCKET SET WITH ACCESSORIES METRIC 6 POINT

HEAVY DUTY 1/4" 6

EVA COVER S SMALL TRAY

28 PIECES



CONTENT



ITEM	PIECES	DESCRIPTION	AVAILABILITY
CH103	28	Socket set with accessories	1 ✓
CH103-C	1	EVA	1 On Request

1/4" DRIVE SHORT AND DEEP SOCKET SET WITH ACCESSORIES SAE 6 POINT

HEAVY DUTY 1/4" 6

EVA COVER S SMALL TRAY

26 PIECES



CONTENT



ITEM	PIECES	DESCRIPTION	AVAILABILITY
CH102	26	Socket set with accessories	1 ✓
CH102-C	1	EVA	1 On Request

3/8" DRIVE SOCKET SETS WITH ACCESSORIES WITH EVA LAMINATED PLASTIC COVER TRAY

3/8" DRIVE SAE SHORT AND DEEP SOCKET SET WITH ACCESSORIES 12 POINT AND 6 POINT

HEAVY DUTY 3/8" 12 6 LAMINATED COVER M MEDIUM TRAY

35 PIECES



CONTENT



ITEM	PIECES	DESCRIPTION	AVAILABILITY
CH201L	35	Socket set with accessories	1 ✓
CH201L-C	1	EVA laminated plastic cover	1 On Request

3/8" DRIVE METRIC SHORT AND DEEP SOCKET SET WITH ACCESSORIES 12 POINT AND 6 POINT

HEAVY DUTY 3/8" 12 6 LAMINATED COVER M MEDIUM TRAY

35 PIECES



CONTENT



ITEM	PIECES	DESCRIPTION	AVAILABILITY
CH202L	35	Socket set with accessories	1 ✓
CH202L-C	1	EVA laminated plastic cover	1 On Request

## 3/8" DRIVE SOCKET SETS WITH ACCESSORIES WITH EVA LAMINATED PLASTIC COVER TRAY

### 3/8" DRIVE SAE AND METRIC SHORT SOCKET SET WITH ACCESSORIES 6 POINT

**URREA**  
SUPERIOR QUALITY AFFORDABLE TOOLS

INDUSTRIAL DUTY **3/8"** **6** **6**

LAMINATED COVER

**S** SMALL TRAY

**34** PIECES

CONTENT

ITEM	PIECES	DESCRIPTION	☑	AVAILABLE
CH104L	34	Socket set with accessories	1	On Request
CH104L-C	1	EVA laminated plastic cover	1	On Request

### 3/8" DRIVE SAE SHORT AND DEEP SOCKET SET 6 POINT

**URREA**  
SUPERIOR QUALITY AFFORDABLE TOOLS

HEAVY DUTY **3/8"** **6**

LAMINATED COVER

**S** SMALL TRAY

**26** PIECES

CONTENT

ITEM	PIECES	DESCRIPTION	☑	AVAILABLE
CH106L	26	Socket set with accessories	1	On Request
CH106L-C	1	EVA laminated plastic cover	1	On Request

### 3/8" DRIVE METRIC SHORT AND DEEP SOCKET SET 6 POINT

**URREA**  
SUPERIOR QUALITY AFFORDABLE TOOLS

HEAVY DUTY **3/8"** **6**

LAMINATED COVER

**S** SMALL TRAY

**24** PIECES

CONTENT

ITEM	PIECES	DESCRIPTION	☑	AVAILABLE
CH107L	24	Socket set with accessories	1	On Request
CH107L-C	1	EVA laminated plastic cover	1	On Request

### 3/8" DRIVE SOCKET BIT SAE HEXAGONAL, METRIC HEXAGONAL AND TORX TIPS SET

**URREA**  
SUPERIOR QUALITY AFFORDABLE TOOLS

HEAVY DUTY **3/8"** **6** **6** **6**

LAMINATED COVER

**S** SMALL TRAY

**22** PIECES

CONTENT

ITEM	PIECES	DESCRIPTION	☑	AVAILABLE
CH108L	22	Socket set with accessories	1	✓
CH108L-C	1	EVA laminated plastic cover	1	On Request

### 3/8" DRIVE SOCKET SETS WITH ACCESSORIES WITH EVA TRAY

**URREA**  
SUPERIOR QUALITY AFFORDABLE TOOLS

HEAVY DUTY **3/8"** **12** **6**

EVA COVER

**M** MEDIUM TRAY

**35** PIECES

CONTENT

ITEM	PIECES	DESCRIPTION	☑	AVAILABLE
CH201	35	Socket set with accessories	1	✓
CH201-C	1	EVA	1	On Request

### 3/8" DRIVE METRIC SHORT AND DEEP SOCKET SET WITH ACCESSORIES 12 POINT AND 6 POINT

**URREA**  
SUPERIOR QUALITY AFFORDABLE TOOLS

HEAVY DUTY **3/8"** **12** **6**

EVA COVER

**M** MEDIUM TRAY

**35** PIECES

CONTENT

ITEM	PIECES	DESCRIPTION	☑	AVAILABLE
CH202	35	Socket set with accessories	1	✓
CH202-C	1	EVA	1	On Request

### 3/8" DRIVE SAE AND METRIC SHORT SOCKET SET WITH ACCESSORIES 6 POINT

**URREA**  
SUPERIOR QUALITY AFFORDABLE TOOLS

HEAVY DUTY **3/8"** **6** **6**

EVA COVER

**S** SMALL TRAY

**34** PIECES

CONTENT

ITEM	PIECES	DESCRIPTION	☑	AVAILABLE
CH104	34	Socket set with accessories	1	On Request
CH104-C	1	EVA	1	On Request

### 3/8" DRIVE SAE SHORT AND DEEP SOCKET SET 6 POINT

**URREA**  
SUPERIOR QUALITY AFFORDABLE TOOLS

HEAVY DUTY **3/8"** **6**

EVA COVER

**S** SMALL TRAY

**26** PIECES

CONTENT

ITEM	PIECES	DESCRIPTION	☑	AVAILABLE
CH106	26	Socket set with accessories	1	✓
CH106-C	1	EVA	1	On Request



3/8" DRIVE SOCKET SETS WITH ACCESSORIES WITH EVA TRAY

3/8" DRIVE METRIC SHORT AND DEEP SOCKET SET 6 POINT



**EVA COVER**  
**S SMALL TRAY**

**24**  
PIECES

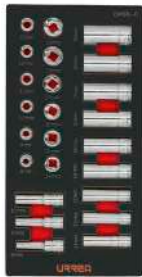

**CONTENT**



3/8" DRIVE SAE AND METRIC SOCKET SET HEXAGONAL AND TORX TIP BITS



**EVA COVER**  
**S SMALL TRAY**

**22**  
PIECES

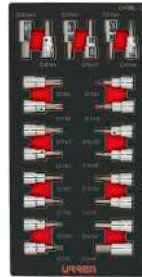

**CONTENT**



3/8" DRIVE ACCESSORIES SET



**EVA COVER**  
**S SMALL TRAY**

**9**  
PIECES



**CONTENT**



ITEM	PIECES	DESCRIPTION	🔗	AVAILABLE
CH107	24	Socket set with accessories	1	✓
CH107-C	1	EVA	1	On Request

ITEM	PIECES	DESCRIPTION	🔗	AVAILABLE
CH108	22	Socket set with accessories	1	✓
CH108-C	1	EVA	1	On Request

ITEM	PIECES	DESCRIPTION	🔗	AVAILABLE
CH105	9	Socket set with accessories	1	✓
CH105-C	1	EVA	1	On Request

1/2" DRIVE SOCKET SETS WITH ACCESSORIES WITH EVA LAMINATED PLASTIC COVER TRAY

1/2" DRIVE SAE AND METRIC SHORT SOCKET SET WITH ACCESSORIES 12 POINT



**42**  
PIECES



**CONTENT**



1/2" DRIVE METRIC SHORT AND DEEP SOCKETS SET WITH ACCESSORIES 12 POINT AND 6 POINT



**37**  
PIECES



**CONTENT**



ITEM	PIECES	DESCRIPTION	🔗	AVAILABLE
CH203L	42	Socket set with accessories	1	✓
CH203L-C	1	EVA laminated plastic cover	1	On Request

ITEM	PIECES	DESCRIPTION	🔗	AVAILABLE
CH311L	37	Socket set with accessories	1	✓
CH311L-C	1	EVA laminated plastic cover	1	On Request

1/2" DRIVE SAE SHORT AND DEEP SOCKETS SET WITH ACCESSORIES 12 POINT AND 6 POINT



**32**  
PIECES



**CONTENT**



1/2" DRIVE SAE AND METRIC SOCKET SET HEXAGONAL AND TORX TIP BITS



**S SMALL TRAY**  
**20**  
PIECES



**CONTENIDO**



ITEM	PIECES	DESCRIPTION	🔗	AVAILABLE
CH310L	32	Socket set with accessories	1	✓
CH310L-C	1	EVA laminated plastic cover	1	On Request

ITEM	PIECES	DESCRIPTION	🔗	AVAILABLE
CH110L	20	Socket set with accessories	1	✓
CH110L-C	1	EVA laminated plastic cover	1	On Request

## 1/2" DRIVE SOCKET SETS WITH ACCESSORIES WITH EVA TRAY

### 1/2" DRIVE SAE AND METRIC SHORT SOCKET SET WITH ACCESSORIES 12 POINT



**42**  
PIECES



CONTENT



ITEM	PIECES	DESCRIPTION	☑	AVAILABLE
CH203	42	Socket set with accessories	1	✓
CH203-C	1	EVA	1	On Request

### 1/2" DRIVE METRIC SHORT AND DEEP SOCKET SET 12 POINT AND 6 POINT



**39**  
PIECES



CONTENT



ITEM	PIECES	DESCRIPTION	☑	AVAILABLE
CH207	39	Socket set with accessories	1	✓
CH207-C	1	EVA	1	On Request

### 1/2" DRIVE METRIC SHORT AND DEEP SOCKET SET WITH ACCESSORIES 12 POINT AND 6 POINT



**37**  
PIECES



CONTENT



ITEM	PIECES	DESCRIPTION	☑	AVAILABLE
CH311	37	Socket set with accessories	1	✓
CH311-C	1	EVA	1	On Request

### 1/2" DRIVE SAE SHORT AND DEEP SOCKET SET WITH ACCESSORIES 12 POINT AND 6 POINT



**32**  
PIECES

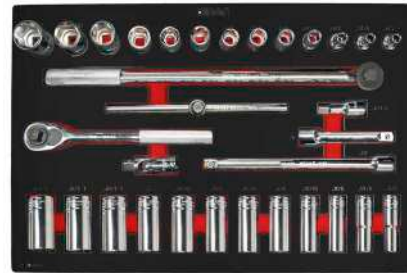

CONTENT



ITEM	PIECES	DESCRIPTION	☑	AVAILABLE
CH310	32	Socket set with accessories	1	✓
CH310-C	1	EVA	1	On Request

### 1/2" DRIVE SAE SHORT AND DEEP SOCKET SET 12 POINT AND 6 POINT



**31**  
PIECES



CONTENT



ITEM	PIECES	DESCRIPTION	☑	AVAILABLE
CH206	31	Socket set with accessories	1	✓
CH206-C	1	EVA	1	On Request

### 1/2" DRIVE SAE AND METRIC SOCKET SET HEXAGONAL AND TORX TIP BITS



**20**  
PIECES



CONTENT



ITEM	PIECES	DESCRIPTION	☑	AVAILABLE
CH110	20	Socket set with accessories	1	✓
CH110-C	1	EVA	1	On Request

### 1/2" DRIVE ACCESSORIES SET



**8**  
PIECES



CONTENT



ITEM	PIECES	DESCRIPTION	☑	AVAILABLE
CH109	8	Socket set with accessories	1	✓
CH109-C	1	EVA	1	On Request

3/4" DRIVE SOCKET SETS WITH ACCESSORIES WITH EVA TRAY

3/4" DRIVE SAE SHORT SOCKET SET WITH ACCESSORIES 12 POINT



27  
PIECES



3/4" DRIVE METRIC SHORT SOCKET SET WITH ACCESSORIES 12 POINT



27  
PIECES



ITEM	PIECES	DESCRIPTION	🔒	AVAILABLE
CH301	27	Socket set with accessories	1	✓
CH301-C	1	EVA	1	On Request

ITEM	PIECES	DESCRIPTION	🔒	AVAILABLE
CH302	27	Socket set with accessories	1	On Request
CH302-C	1	EVA	1	On Request

1/2" DRIVE IMPACT SOCKET SETS WITH EVA TRAY

3/4" DRIVE METRIC SHORT AND DEEP SOCKET SET 6 POINT



M MEDIUM  
TRAY  
30  
PIECES



3/4" DRIVE SAE SHORT AND DEEP SOCKET SET 6 POINT



M MEDIUM  
TRAY  
29  
PIECES



ITEM	PIECES	DESCRIPTION	🔒	AVAILABLE
CH219	30	Socket set with accessories	1	On Request
CH219-C	1	EVA	1	On Request

ITEM	PIECES	DESCRIPTION	🔒	AVAILABLE
CH218	29	Socket set with accessories	1	✓
CH218-C	1	EVA	1	On Request

ADJUSTABLE WRENCHES SETS WITH EVA LAMINATED PLASTIC COVER TRAY

CHROME ADJUSTABLE WRENCH SET



S SMALL  
TRAY  
3  
PIECES

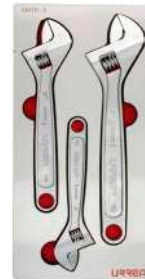

ITEM	PIECES	DESCRIPTION	🔒	AVAILABLE
CH111L	3	Wrenches set	1	✓
CH111L-C	1	EVA laminated plastic cover	1	On Request

BLACK ADJUSTABLE WRENCH SET



S SMALL  
TRAY  
3  
PIECES



ADJUSTABLE WRENCH SETS WITH EVA TRAY

CHROME ADJUSTABLE WRENCH SET



S SMALL  
TRAY  
3  
PIECES



ITEM	PIECES	DESCRIPTION	🔒	AVAILABLE
CH111	3	Wrenches set	1	✓
CH111-C	1	EVA	1	On Request

BLACK ADJUSTABLE WRENCH SET



S SMALL  
TRAY  
3  
PIECES



ITEM	PIECES	DESCRIPTION	🔒	AVAILABLE
CH114	3	Wrenches set	1	On Request
CH111-C	1	EVA	1	On Request

## COMBINATION WRENCH SETS WITH EVA-LAMINATED PLASTIC COVER TRAY

### FULL POLISH METRIC COMBINATION WRENCH SET

HEAVY DUTY 12 C LAMINATED COVER L LARGE TRAY

15 PIECES



ITEM	PIECES	DESCRIPTION	☐	AVAILABLE
CH304L	15	Wrenches set	1	✓
CH304L-C	1	EVA laminated plastic cover	1	On Request

### BLACK METRIC COMBINATION WRENCH SET

HEAVY DUTY 12 C LAMINATED COVER L LARGE TRAY

ZINC PHOSPHATE FINISH  
15 PIECES



ITEM	PIECES	DESCRIPTION	☐	AVAILABLE
CH306L	15	Wrenches set	1	✓
CH306L-C	1	EVA laminated plastic cover	1	On Request

### FULL POLISH METRIC COMBINATION WRENCH SET

HEAVY DUTY 12 C LAMINATED COVER L LARGE TRAY

14 PIECES



ITEM	PIECES	DESCRIPTION	☐	AVAILABLE
CH303L	14	Combination wrenches set	1	✓
CH303L-C	1	EVA laminated plastic cover	1	On Request

### BLACK METRIC COMBINATION WRENCH SET

HEAVY DUTY 12 C LAMINATED COVER L LARGE TRAY

ZINC PHOSPHATE FINISH  
14 PIECES



ITEM	PIECES	DESCRIPTION	☐	AVAILABLE
CH305L	14	Combination wrenches set	1	✓
CH305L-C	1	EVA laminated plastic cover	1	On Request

## COMBINATION WRENCH SETS WITH EVA TRAY

### FULL POLISH METRIC COMBINATION WRENCH SET

HEAVY DUTY 12 C EVA COVER L LARGE TRAY

15 PIECES

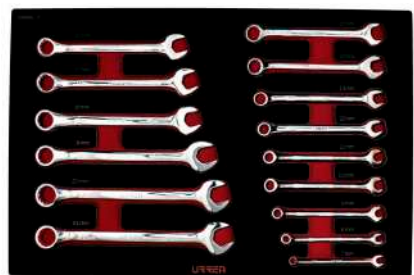

ITEM	PIECES	DESCRIPTION	☐	AVAILABLE
CH304	15	Combination wrenches set	1	✓
CH304-C	1	EVA	1	On Request

### BLACK METRIC COMBINATION WRENCH SET

HEAVY DUTY 12 C EVA COVER L LARGE TRAY

ZINC PHOSPHATE FINISH  
15 PIECES



ITEM	PIECES	DESCRIPTION	☐	AVAILABLE
CH306	15	Combination wrenches set	1	✓
CH304-C	1	EVA	1	On Request

COMBINATION WRENCH SETS WITH EVA TRAY

FULL POLISH SAE COMBINATION WRENCH SET



14  
PIECES



CONTENT



ITEM	PIECES	DESCRIPTION	☑	AVAILABLE
CH303	14	Combination wrenches set	1	✓
CH303-C	1	EVA	1	On Request

BLACK SAE COMBINATION WRENCH SET



14  
PIECES

ZINC PHOSPHATE FINISH



CONTENT



ITEM	PIECES	DESCRIPTION	☑	AVAILABLE
CH305	14	Combination wrenches set	1	On Request
CH303-C	1	EVA	1	On Request

FULL POLISH METRIC COMBINATION WRENCH SET



12  
PIECES



CONTENT



ITEM	PIECES	DESCRIPTION	☑	AVAILABLE
CH316	12	Combination wrenches set	1	On Request
CH316-C	1	EVA	1	On Request

FULL POLISH SAE COMBINATION WRENCH SET



11  
PIECES



CONTENT



ITEM	PIECES	DESCRIPTION	☑	AVAILABLE
CH314	11	Combination wrenches set	1	On Request
CH314-C	1	EVA	1	On Request

OPEN-END WRENCH SETS WITH EVA TRAY

SAE OPEN-END WRENCH SET



10  
PIECES



CONTENT



ITEM	PIECES	DESCRIPTION	☑	AVAILABLE
CH215	10	Combination wrenches set	1	On Request
CH215-C	1	EVA	1	On Request

METRIC OPEN-END WRENCH SET



10  
PIECES



CONTENT



ITEM	PIECES	DESCRIPTION	☑	AVAILABLE
CH216	10	Combination wrenches set	1	On Request
CH216-C	1	EVA	1	On Request

## 45° BOX-END WRENCH SETS WITH EVA TRAY

### SAE 45° BOX-END WRENCH

HEAVY DUTY 12 EVA COVER M MEDIUM TRAY

7 PIECES



URREA



CONTENT



### METRIC 45° BOX-END WRENCH

HEAVY DUTY 12 EVA COVER M MEDIUM TRAY

7 PIECES



URREA



CONTENT



ITEM	PIECES	DESCRIPTION	☐	AVAILABLE
CH213	7	Combination wrenches set	1	On Request
CH213-C	1	EVA	1	On Request

ITEM	PIECES	DESCRIPTION	☐	AVAILABLE
CH214	7	Combination wrenches set	1	On Request
CH214-C	1	EVA	1	On Request

## COMBINATION RATCHET WRENCH SETS WITH EVA LAMINATED PLASTIC COVER

### METRIC COMBINATION RATCHET WRENCH SET

HEAVY DUTY 12 C LAMINATED COVER L LARGE TRAY

15 PIECES



URREA



CONTENT



### SAE COMBINATION RATCHET WRENCH SET

HEAVY DUTY 12 C LAMINATED COVER L LARGE TRAY

12 PIECES



URREA



CONTENT



ITEM	PIECES	DESCRIPTION	☐	AVAILABLE
CH313L	15	Combination wrenches set	1	✓
CH313L-C	1	EVA laminated plastic cover	1	On Request

ITEM	PIECES	DESCRIPTION	☐	AVAILABLE
CH312L	12	Combination wrenches set	1	✓
CH312L-C	1	EVA laminated plastic cover	1	On Request

## COMBINATION RATCHET WRENCH SETS WITH EVA TRAY

### METRIC COMBINATION RATCHET WRENCH SET

HEAVY DUTY 12 C EVA COVER L LARGE TRAY

15 PIECES



URREA



CONTENT



### SAE COMBINATION RATCHET WRENCH SET

HEAVY DUTY 12 C EVA COVER L LARGE TRAY

12 PIECES



URREA



CONTENT



ITEM	PIECES	DESCRIPTION	☐	AVAILABLE
CH313	15	Combination wrenches set	1	✓
CH313-C	1	EVA	1	On Request

ITEM	PIECES	DESCRIPTION	☐	AVAILABLE
CH312	12	Combination wrenches set	1	✓
CH312-C	1	EVA	1	On Request

OFFSET RATCHETING BOX-END WRENCH SETS WITH EVA TRAY

**FULL POLISH METRIC OFFSET RATCHETING BOX-END WRENCH SETS WITH EVA TRAY**

URREA

HEAVY DUTY 12

EVA COVER

S SMALL TRAY

7 PIECES

CONTENT

**FULL POLISH SAE OFFSET RATCHETING BOX-END WRENCH SETS WITH EVA TRAY**

URREA

HEAVY DUTY 12

EVA COVER

S SMALL TRAY

6 PIECES

CONTENT

STRIKING SCREWDRIVER SET WITH EVA TRAY

**BIMATERIAL STRIKING SCREWDRIVERS SET WITH EVA TRAY**

URREA

HEAVY DUTY

EVA COVER

S SMALL TRAY

7 PIECES

CONTENT

ITEM	PIECES	DESCRIPTION	AVAILABLE
CH113	7	Combination wrenches set	On Request
CH113-C	1	EVA	On Request

ITEM	PIECES	DESCRIPTION	AVAILABLE
CH112	6	Combination wrenches set	On Request
CH112-C	1	EVA	On Request

ITEM	PIECES	DESCRIPTION	AVAILABLE
CH128	7	Striking screwdriver set	On Request
CH128-C	1	EVA	On Request

BIMATERIAL SCREWDRIVER SETS WITH EVA LAMINATED PLASTIC COVER TRAY

**BIMATERIAL SCREWDRIVERS SET TIP FLAT, PHILLIPS AND CABINET WITH TRAY LAMINATED**

URREA

HEAVY DUTY

LAMINATED COVER

L LARGE TRAY

19 PIECES

CONTENT

**METRIC BIMATERIAL NUT DRIVER WITH TRAY LAMINATED**

URREA

HEAVY DUTY

LAMINATED COVER

M MEDIUM TRAY

9 PIECES

CONTENT

ITEM	PIECES	DESCRIPTION	AVAILABLE
CH307L	19	Screwdrivers set	✓
CH307L-C	1	EVA laminated plastic cover	On Request

ITEM	PIECES	DESCRIPTION	AVAILABLE
CH210L	9	Screwdrivers set	✓
CH210L-C	1	EVA laminated plastic cover	On Request

**BIMATERIAL SCREWDRIVER TIP FLAT, PHILLIPS AND CABINET WITH TRAY LAMINATED**

URREA

HEAVY DUTY

LAMINATED COVER

S SMALL TRAY

6 PIECES

CONTENT

**SAE BIMATERIAL NUT DRIVERS WITH TRAY LAMINATED**

URREA

HEAVY DUTY

LAMINATED COVER

S SMALL TRAY

6 PIECES

CONTENT

ITEM	PIECES	DESCRIPTION	AVAILABLE
CH115L	6	Screwdrivers set	✓
CH115L-C	1	EVA laminated plastic cover	On Request

ITEM	PIECES	DESCRIPTION	AVAILABLE
CH118L	6	Screwdrivers set	✓
CH118L-C	1	EVA laminated plastic cover	On Request

## BIMATERIAL SCREWDRIVER SETS WITH EVA TRAY

### BIMATERIAL SCREWDRIVERS SET TIP FLAT, PHILLIPS AND CABINET



**19**  
PIECES



### METRIC BIMATERIAL NUT DRIVERS



**9**  
PIECES



ITEM	PIECES	DESCRIPTION	📦	AVAILABLE
CH307	19	Juego de destornilladores	1	✓
CH307-C	1	EVA	1	On Request

ITEM	PIECES	DESCRIPTION	📦	AVAILABLE
CH210	9	Screwdriver set	1	✓
CH210-C	1	EVA	1	On Request

### CABINET AND FLAT TIP BIMATERIAL SCREWDRIVERS



**7**  
PIECES



### CABINET, PHILLIPS AND FLAT TIP BIMATERIAL SCREWDRIVERS



**6**  
PIECES



### PHILLIPS TIP BIMATERIAL SCREWDRIVERS



**6**  
PIECES



ITEM	PIECES	DESCRIPTION	📦	AVAILABLE
CH117	7	Screwdriver set	1	✓
CH117-C	1	EVA	1	On Request

ITEM	PIECES	DESCRIPTION	📦	AVAILABLE
CH115	6	Screwdriver set	1	✓
CH115-C	1	EVA	1	On Request

ITEM	PIECES	DESCRIPTION	📦	AVAILABLE
CH116	6	Screwdriver set	1	On Request
CH116-C	1	EVA	1	On Request

### SAE BIMATERIAL NUT DRIVERS



**6**  
PIECES



### TORX TIP BIMATERIAL SCREWDRIVERS



**6**  
PIECES



### 1000 V TRIMATERIAL SCREWDRIVERS SET WITH EVA LAMINATED PLASTIC COVER TRAY



**8**  
PIECES



ITEM	PIECES	DESCRIPTION	📦	AVAILABLE
CH118	6	Screwdriver set	1	✓
CH118-C	1	EVA	1	On Request

ITEM	PIECES	DESCRIPTION	📦	AVAILABLE
CH129	6	Screwdriver set	1	On Request
CH129-C	1	EVA	1	On Request

ITEM	PIECES	DESCRIPTION	📦	AVAILABLE
CH119L	8	Screwdriver set	1	On Request
CH119L-C	1	EVA laminated plastic cover	1	On Request



1000 V TRIMATERIAL SCREWDRIVERS SET

1000 V PHILLIPS AND FLAT TIP TRIMATERIAL SCREWDRIVERS



**EVA COVER**  
**S SMALL TRAY**

**8 PIECES**



ITEM	PIECES	DESCRIPTION	🔒	AVAILABLE
CH119	8	Screwdriver set	1	✓
CH119-C	1	EVA	1	On Request

HEXAGONAL KEY SET WITH EVALAMINATED PLASTIC COVER TRAY

SAE AND METRIC HEXAGONAL AND TORX KEYS



**INDUSTRIAL DUTY**  
**LAMINATED COVER**  
**S SMALL TRAY**

**46 PIECES**



ITEM	PIECES	DESCRIPTION	🔒	AVAILABLE
CH120L	46	SAE & metric hex & Torx keys set	1	✓
CH120L-C	1	EVA laminated plastic cover	1	On Request

HEXAGONAL KEY SET WITH EVA TRAY

SAE AND METRIC HEXAGONAL AND TORX KEYS



**INDUSTRIAL DUTY**  
**EVA COVER**  
**S SMALL TRAY**

**46 PIECES**



ITEM	PIECES	DESCRIPTION	🔒	AVAILABLE
CH120	46	SAE & metric hex & Torx keys set	1	✓
CH120-C	1	EVA	1	On Request

LOCKING PLIERS SET WITH EVALAMINATED PLASTIC COVER TRAY

LOCKING PLIERS



**S SMALL TRAY**

**4 PIECES**



ITEM	PIECES	DESCRIPTION	🔒	AVAILABLE
CH127L	4	Locking pliers set	1	✓
CH127L-C	1	EVA laminated plastic cover	1	On Request

LOCKING PLIERS SET WITH EVA TRAY

LOCKING PLIERS SET



**S SMALL TRAY**

**4 PIECES**



ITEM	PIECES	DESCRIPTION	🔒	AVAILABLE
CH127	4	Locking pliers set	1	On Request
CH127-C	1	EVA	1	On Request

BIMATERIAL PLIER SET WITH EVALAMINATED PLASTIC COVER TRAY

BIMATERIAL PLIERS SET WITH LAMINATED TRAY



**M MEDIUM TRAY**

**7 PIECES**



ITEM	PIECES	DESCRIPTION	🔒	AVAILABLE
CH212L	7	Bimaterial pliers set	1	✓
CH212L-C	1	EVA laminated plastic cover	1	On Request

BIMATERIAL PLIER SET WITH EVA TRAY

BIMATERIAL PLIERS SET



**M MEDIUM TRAY**

**7 PIECES**



ITEM	PIECES	DESCRIPTION	🔒	AVAILABLE
CH212	7	Bimaterial pliers set	1	✓
CH212-C	1	EVA	1	On Request

ELECTRICIAN PLIERS SET WITH EVA LAMINATED PLASTIC COVER TRAY

ELECTRICIAN PLIERS SET



**S SMALL TRAY**

**4 PIECES**



ITEM	PIECES	DESCRIPTION	🔒	AVAILABLE
CH126L	4	Electrician plier set	1	✓
CH126L-C	1	EVA laminated plastic cover	1	On Request

ELECTRICIAN PLIERS SET WITH EVA TRAY

ELECTRICIAN PLIERS SET



**S SMALL TRAY**

**4 PIECES**



ITEM	PIECES	DESCRIPTION	🔒	AVAILABLE
CH126	4	Electrician plier set	1	✓
CH126-C	1	EVA	1	On Request

## WIRE STRIPPING PLIERS SET WITH EVA TRAY

### WIRE STRIPPING PLIERS SET



**S** SMALL TRAY

**5** PIECES



CONTENT



ITEM	PIECES	DESCRIPTION	🔒	AVAILABLE
CH130	5	Juego de pinzas	1	On Request
CH130-C	1	EVA	1	On Request

## HAMMER SET WITH EVA TRAY

### BALL-PEIN HAMMERS, PLASTIC AND RUBBER HAMMERS AND MALLET



**5** PIECES



CONTENT



ITEM	PIECES	DESCRIPTION	🔒	AVAILABLE
CH308	5	Hammers set	1	✓
CH308-C	1	EVA	1	On Request

## CHISEL, PUNCH AND DRIFT PIN SETS WITH EVA LAMINATED PLASTIC COVER TRAY

### GOLD CHISEL SET WITH EVA LAMINATED TRAY



**S** SMALL TRAY

**8** PIECES

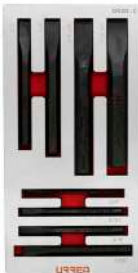

CONTENT



ITEM	PIECES	DESCRIPTION	🔒	AVAILABLE
CH122L	8	Chisels set	1	✓
CH122L-C	1	EVA laminated plastic cover	1	On Request

## CHISEL, PUNCH AND DRIFT PIN SETS

### CHISEL, PUNCH AND DRIFT PIN SET



**26** PIECES

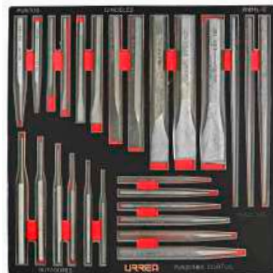

CONTENT



ITEM	PIECES	DESCRIPTION	🔒	AVAILABLE
CH211	26	Drift pins, punches & chisels	1	On Request
CH211-C	1	EVA	1	On Request

### PUNCH, DRIZZLE AND CENTER POINT SET



**12** PIECES



CONTENT



ITEM	PIECES	DESCRIPTION	🔒	AVAILABLE
CH123	12	Pin punches & center punches	1	✓
CH123-C	1	EVA	1	On Request

## FIXED RETAINING RING PLIERS SET WITH EVA TRAY

### FIXED RETAINING RING PLIERS SET



**S** SMALL TRAY

**4** PIECES

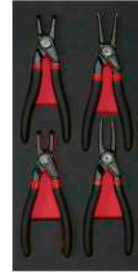

CONTENT



ITEM	PIECES	DESCRIPTION	🔒	AVAILABLE
CH131	4	Fixed retaining ring pliers	1	✓
CH131-C	1	EVA	1	On Request

## CHISEL, PUNCH AND DRIFT PIN SETS WITH EVA LAMINATED PLASTIC COVER TRAY

### CHISEL, PUNCH AND DRIFT PIN SETS



**26** PIECES

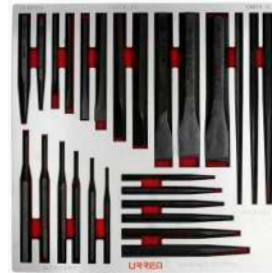

CONTENT



ITEM	PIECES	DESCRIPTION	🔒	AVAILABLE
CH211L	26	Drift pins, punches & chisels	1	✓
CH211L-C	1	EVA laminated plastic cover	1	On Request

CHISEL, PUNCH AND DRIFT PIN SETS

PUNCH AND CHISEL SET

HEAVY DUTY EVA COVER S SMALL TRAY

10 PIECES



CONTENT



ITEM	PIECES	DESCRIPTION	🔒	AVAILABLE
CH121	10	Chisels and pin punches	1	On Request
CH121-C	1	EVA	1	On Request

COLD CHISEL SET

HEAVY DUTY EVA COVER S SMALL TRAY

8 PIECES



CONTENT



ITEM	PIECES	DESCRIPTION	🔒	AVAILABLE
CH122	8	Chisels	1	✓
CH122-C	1	EVA	1	On Request

LONG TAPERED DRIFT PUNCHES SET

HEAVY DUTY EVA COVER S SMALL TRAY

7 PIECES



CONTENT



ITEM	PIECES	DESCRIPTION	🔒	AVAILABLE
CH124	7	Long drift punches	1	✓
CH124-C	1	EVA	1	On Request

1000 V PLIERS AND ADJUSTABLE WRENCH SET WITH EVA TRAY

1000 V PLIERS AND ADJUSTABLE WRENCH SET

SUPER DUTY EVA COVER M MEDIUM TRAY

5 PIECES



CONTENT



ITEM	PIECES	DESCRIPTION	🔒	AVAILABLE
CH220	5	1000 V pliers and adjustable wrench	1	On Request
CH220-C	1	EVA	1	On Request

PIPE TOOL SETS WITH EVA TRAY

PIPE TOOL SETS

SUPER DUTY EVA COVER L LARGE TRAY

5 PIECES



CONTENT



ITEM	PIECES	DESCRIPTION	🔒	AVAILABLE
CH309	5	Pipe wrenches, pipe cutters and flaring tool	1	✓
CH309-C	1	EVA	1	On Request

PIPE WRENCH, PIPE CUTTER AND FLARING TOOL SET

SUPER DUTY EVA COVER S SMALL TRAY

3 PIECES



CONTENT



ITEM	PIECES	DESCRIPTION	🔒	AVAILABLE
CH125	3	Pipe wrenches, pipe cutters and flaring tool	1	On Request
CH125-C	1	EVA	1	On Request

PULLER SETS WITH EVA TRAY

PULLER SET 10 TON

HEAVY DUTY EVA COVER M MEDIUM TRAY

14 PIECES



CONTENT



ITEM	PIECES	DESCRIPTION	🔒	AVAILABLE
CH221	14	10 Ton straight jaw puller	1	✓
CH221-C	1	EVA	1	On Request

REVERSIBLE JAW PULLERS AND BEARING SEPARATORS SET

INDUSTRIAL DUTY EVA COVER M MEDIUM TRAY

5 PIECES



CONTENT



ITEM	PIECES	DESCRIPTION	🔒	AVAILABLE
CH222	5	Reversible jaw pullers and bearing separators	1	✓
CH222-C	1	EVA	1	On Request

## STRAIGHT FLUTE EXTRACTOR SET WITH EVA TRAY

### STRAIGHT FLUTE EXTRACTOR SET

INDUSTRIAL DUTY EVA COVER S SMALL TRAY

9 PIECES



URREA



CONTENT



ITEM	PIECES	DESCRIPTION	AVAILABLE
CH132	9	Straight flute extractor set	1 ✓
CH132-C	1	EVA	1 On Request

## MISCELLANEOUS TOOL SET WITH EVA TRAY

### MISCELLANEOUS TOOL SET

INDUSTRIAL DUTY EVA COVER L LARGE TRAY

12 PIECES



URREA



CONTENT



ITEM	PIECES	DESCRIPTION	AVAILABLE
CH315	12	Tool set	1 ✓
CH315-C	1	EVA	1 On Request

## MEASURING TOOL SET WITH EVA TRAY

### MEASURING TOOL SET

INDUSTRIAL DUTY EVA COVER M MEDIUM TRAY

8 PIECES



URREA



CONTENT



ITEM	PIECES	DESCRIPTION	AVAILABLE
CH223	8	Tool set	1 ✓
CH223-C	1	EVA	1 On Request

**URREA**  
SUPERIOR QUALITY AFFORDABLE TOOLS

SUPERIOR  
Extraction

usa.urrea.com      STRAIGHT FLUTE EXTRACTOR SET

## MODULAR WALL ORGANIZATION SYSTEM

### WHAT IS IT?

A modular tool organization system with trays that can be mounted on a wall or panel.

### ADVANTAGES:

- Made of EVA foam.
- Two modular sizes available.
- Ideal for lightweight tools.
- All trays have a thickness of 1-3/16".
- Equipped with holes for wall mounting.



TRAY – EVA

This is a tray made of EVA foam with a thickness of 1-3/16 inches [30 mm]. The tray features a dual-color design for better organization and tool control. It includes engraved size markings for easy identification. EVA foam is resistant to tearing and to a wide range of chemicals.

COMBINATION TOOL SETS WITH WALL-MOUNT EVA TRAY

COMBINATION TOOL SET



8 PIECES



ITEM	PIECES	DESCRIPTION	☑	AVAILABLE
CH213P	8	Basic tool set	1	✓
CH213P-C	1	EVA	1	✓

1000 V INSULATED COMBINATION TOOL SET



L LARGE TRAY  
9 PIECES



ITEM	PIECES	DESCRIPTION	☑	AVAILABLE
CH214P	9	1000 V Insulated tool set	1	✓
CH214P-C	1	EVA	1	✓

1/4" DRIVE SOCKET AND HAND ACCESSORY SET WITH WALL-MOUNT EVA TRAY

1/4" DRIVE COMBINATION SOCKET AND ACCESSORY SET



S SMALL TRAY  
48 PIECES



ITEM	PIECES	DESCRIPTION	☑	AVAILABLE
CH111P	48	1/4" Drive combination socket and accessory set	1	✓
CH111P-C	1	EVA	1	✓

3/8" DRIVE SOCKET AND HAND ACCESSORY SET WITH WALL-MOUNT EVA TRAY

3/8" DRIVE COMBINATION SOCKET AND ACCESSORY SET



L LARGE TRAY  
35 PIECES

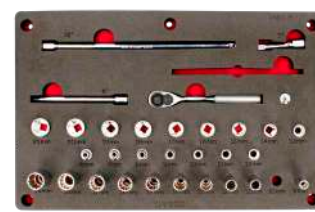

ITEM	PIECES	DESCRIPTION	☑	AVAILABLE
CH212P	35	3/8" Drive combination socket and accessory set	1	✓
CH212P-C	1	EVA	1	✓

1/2" DRIVE SOCKET AND HAND ACCESSORY SETS WITH WALL-MOUNT EVA TRAY

1/2" DRIVE METRIC SOCKET SET



L LARGE TRAY  
39 PIECES



ITEM	PIECES	DESCRIPTION	☑	AVAILABLE
CH232P	39	1/2" Drive metric socket set	1	✓
CH232P-C	1	EVA	1	✓

1/2" DRIVE SAE SOCKET SET



L LARGE TRAY  
32 PIECES



ITEM	PIECES	DESCRIPTION	☑	AVAILABLE
CH231P	32	1/2" Drive SAE socket set	1	✓
CH231P-C	1	EVA	1	✓

1/2" DRIVE COMBINATION SOCKET SET



EVA COVER  
L LARGE TRAY  
20 PIECES



ITEM	PIECES	DESCRIPTION	☑	AVAILABLE
CH211P	20	1/2" Drive combination socket set	1	✓
CH211P-C	1	EVA	1	✓

## 1/2" DRIVE IMPACT SOCKET SETS WITH WALL-MOUNT EVA TRAY

### 1/2" DRIVE IMPACT METRIC SOCKET SET

**HEAVY DUTY** **METRIC** **1/2"** **6** **EVA COVER**

**L** **LARGE TRAY**

**30** **PIECES**

**URREA**  
SUPERIOR QUALITY AFFORDABLE TOOLS

**NEW**

**CONTENT**

### 1/2" DRIVE IMPACT SAE SOCKET SET

**HEAVY DUTY** **INCHES** **1/2"** **6** **EVA COVER**

**L** **LARGE TRAY**

**29** **PIECES**

**URREA**  
SUPERIOR QUALITY AFFORDABLE TOOLS

**NEW**

**CONTENT**

ITEM	PIECES	DESCRIPTION	☑	AVAILABLE
CH242P	30	1/2" Drive impact metric socket set	1	✓
CH242P-C	1	EVA	1	✓

ITEM	PIECES	DESCRIPTION	☑	AVAILABLE
CH241P	29	1/2" Drive impact SAE socket set	1	✓
CH241P-C	1	EVA	1	✓

## RATCHET WRENCH SETS WITH WALL-MOUNT EVA TRAY

### METRIC FULL POLISH COMBINATION RATCHET WRENCH SET

**HEAVY DUTY** **METRIC** **C** **12** **EVA COVER**

**L** **LARGE TRAY**

**RATCHET SYSTEM**

**15** **PIECES**

**URREA**  
SUPERIOR QUALITY AFFORDABLE TOOLS

**NEW**

**CONTENT**

### SAE FULL POLISH COMBINATION RATCHET WRENCH SET

**HEAVY DUTY** **INCHES** **C** **12** **EVA COVER**

**L** **LARGE TRAY**

**RATCHET SYSTEM**

**12** **PIECES**

**URREA**  
SUPERIOR QUALITY AFFORDABLE TOOLS

**NEW**

**CONTENT**

ITEM	PIECES	DESCRIPTION	☑	AVAILABLE
CH256P	15	Metric combination ratchet wrench set	1	✓
CH256P-C	1	EVA	1	✓

ITEM	PIECES	DESCRIPTION	☑	AVAILABLE
CH255P	12	SAE combination ratchet wrench set	1	✓
CH255P-C	1	EVA	1	✓

## COMBINATION WRENCH SETS WITH WALL-MOUNT EVA TRAY

### SAE FULL POLISH COMBINATION WRENCH SET

**HEAVY DUTY** **INCHES** **C** **12** **EVA COVER**

**L** **LARGE TRAY**

**13** **PIECES**

**URREA**  
SUPERIOR QUALITY AFFORDABLE TOOLS

**NEW**

**CONTENT**

### SAE FULL POLISH EXTRA LONG COMBINATION WRENCH SET

**HEAVY DUTY** **INCHES** **C** **12** **EVA COVER**

**L** **LARGE TRAY**

**XL** **EXTRA LARGE**

**11** **PIECES**

**URREA**  
SUPERIOR QUALITY AFFORDABLE TOOLS

**NEW**

**CONTENT**

ITEM	PIECES	DESCRIPTION	☑	AVAILABLE
CH252P	13	SAE Combination wrench set	1	✓
CH252P-C	1	EVA	1	✓

ITEM	PIECES	DESCRIPTION	☑	AVAILABLE
CH251P	11	SAE Extra long combination wrench set	1	✓
CH251P-C	1	EVA	1	✓

## OPEN-END WRENCH SETS WITH WALL-MOUNT EVA TRAY

### SAE FULL POLISH OPEN-END WRENCH SET

**HEAVY DUTY** **INCHES** **C** **EVA COVER**

**L** **LARGE TRAY**

**10** **PIECES**

**URREA**  
SUPERIOR QUALITY AFFORDABLE TOOLS

**NEW**

**CONTENT**

### METRIC FULL POLISH OPEN-END WRENCH SET

**HEAVY DUTY** **METRIC** **C** **EVA COVER**

**L** **LARGE TRAY**

**10** **PIECES**

**URREA**  
SUPERIOR QUALITY AFFORDABLE TOOLS

**NEW**

**CONTENT**

ITEM	PIECES	DESCRIPTION	☑	AVAILABLE
CH253P	10	SAE open-end wrench set	1	✓
CH253P-C	1	EVA	1	✓

ITEM	PIECES	DESCRIPTION	☑	AVAILABLE
CH254P	10	Metric open-end wrench set	1	✓
CH254P-C	1	EVA	1	✓

ADJUSTABLE WRENCH SET WITH WALL-MOUNT EVA TRAY

ADJUSTABLE WRENCH SET

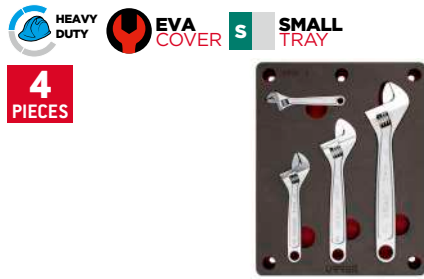

ITEM	PIECES	DESCRIPTION	☑	AVAILABLE
CH151P	4	Adjustable wrench set	1	✓
CH151P-C	1	EVA	1	✓

IMPACT SCREWDRIVER SET WITH WALL-MOUNT EVA TRAY

COMBINATION IMPACT BIMATERIAL SCREWDRIVER SET

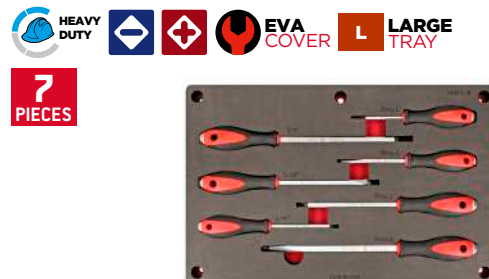

ITEM	PIECES	DESCRIPTION	☑	AVAILABLE
CH273P	7	Combination impact screwdriver set	1	✓
CH273P-C	1	EVA	1	✓

BIMATERIAL SCREWDRIVER SET WITH WALL-MOUNT EVA TRAY

COMBINATION BIMATERIAL SCREWDRIVER SET

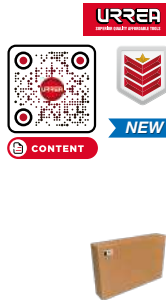

ITEM	PIECES	DESCRIPTION	☑	AVAILABLE
CH271P	10	Combination bimaterial screwdriver set	1	✓
CH271P-C	1	EVA	1	✓

COMBINATION BIMATERIAL NUT DRIVER SET

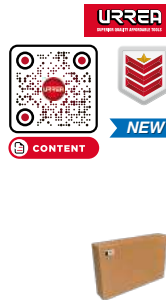
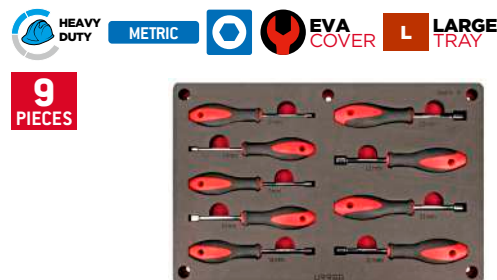

ITEM	PIECES	DESCRIPTION	☑	AVAILABLE
CH275P	9	Bimaterial nut driver set	1	✓
CH275P-C	1	EVA	1	✓

1000 V INSULATED TRIMATERIAL SCREWDRIVER SET WITH WALL-MOUNT EVA TRAY

1000 V INSULATED TRIMATERIAL COMBINATION SCREWDRIVER SET

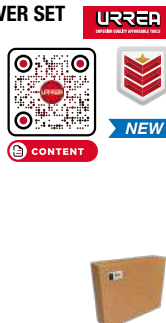

ITEM	PIECES	DESCRIPTION	☑	AVAILABLE
CH171P	6	1000 V Insulated screwdriver set	1	✓
CH171P-C	1	EVA	1	✓

HEX KEY AND FOLDING HEX KEY SETS WITH WALL-MOUNT EVA TRAY

T-HANDLE SAE HEX KEY SET

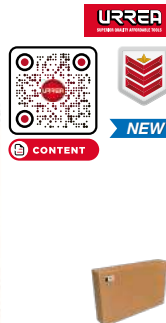

ITEM	PIECES	DESCRIPTION	☑	AVAILABLE
CH272P	8	T-Handle SAE hex key set	1	✓
CH272P-C	1	EVA	1	✓

T-HANDLE METRIC HEX KEY SET

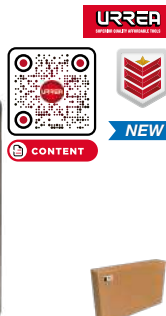
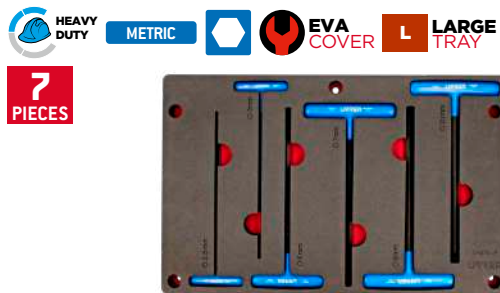

ITEM	PIECES	DESCRIPTION	☑	AVAILABLE
CH274P	7	T-Handle metric hex key set	1	✓
CH274P-C	1	EVA	1	✓

T-HANDLE TORX HEX KEY SET



ITEM	PIECES	DESCRIPTION	☑	AVAILABLE
CH276P	9	T-Handle Torx hex key set	1	✓
CH276P-C	1	EVA	1	✓

## HEX KEY AND FOLDING HEX KEY SETS WITH WALL-MOUNT EVA TRAY

### COMBINATION HEX KEY AND FOLDING HEX KEY SET

HEAVY DUTY INCHES TORX® METRIC

EVA COVER S SMALL TRAY

46 PIECES



URREA



NEW



CONTENT



ITEM	PIECES	DESCRIPTION	☐	AVAILABLE
CH172P	46	Hex key set	1	✓
CH172P-C	1	EVA	1	✓

## COMBINATION PLIERS SETS WITH WALL-MOUNT EVA TRAY

### COMBINATION PLIERS SET

HEAVY DUTY EVA COVER L LARGE TRAY

7 PIECES

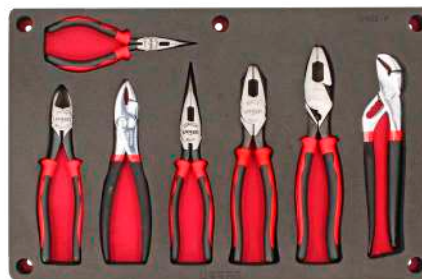

URREA



NEW



CONTENT



ITEM	PIECES	DESCRIPTION	☐	AVAILABLE
CH282P	7	Combination pliers set	1	✓
CH282P-C	1	EVA	1	✓

### COMBINATION PLIERS SET

HEAVY DUTY EVA COVER L LARGE TRAY

10 PIECES



URREA



NEW



CONTENT



ITEM	PIECES	DESCRIPTION	☐	AVAILABLE
CH283P	10	Combination pliers set	1	✓
CH283P-C	1	EVA	1	✓

### COMBINATION PLIERS SET

HEAVY DUTY EVA COVER L LARGE TRAY

6 PIECES



URREA



NEW



CONTENT



ITEM	PIECES	DESCRIPTION	☐	AVAILABLE
CH281P	6	Combination pliers set	1	✓
CH281P-C	1	EVA	1	✓

## LOCKING PLIERS SET WITH WALL-MOUNT EVA TRAY

### LOCKING PLIERS SET

HEAVY DUTY EVA COVER S SMALL TRAY

4 PIECES



URREA



NEW



CONTENT



ITEM	PIECES	DESCRIPTION	☐	AVAILABLE
CH181P	4	Locking pliers set	1	✓
CH181P-C	1	EVA	1	✓

**URREA**  
SUPERIOR QUALITY AFFORDABLE TOOLS

SUPERIOR  
Protection

COMBINATION HEX KEY AND FOLDING HEX KEY SET

usa.urrea.com





CLASS	TYPE	PAGE	BRAND	
			URREA	SURTEK
Jobsite boxes	Metal storage trunk	64	•	
	Metal boxes	64	•	•
Tool boxes	Plastic boxes	65	•	•
	Plastic drawers	72		•
Tool utility cart	Sheet metal utility carts	72	•	•
	Wire utility carts	73	•	
	Plastic utility carts	74	•	
Load accessories	Double-arm utility hooks	74		•
Workbench	Workstations	74	•	
	Fixed cabinets	76	•	
Cabinets	Coat hooks	77	•	
	Mobile cabinets	79	•	•
	Tool cases	90	•	•
Tool holders	Tool bags	91	•	
	Leather tool holder	92	•	•
	Polyester tool holder	93	•	•
Rails and socket clips	Plumber tool sets	93	•	
	Socket rails and clips	93	•	

[usa.urrea.com](http://usa.urrea.com)

We are constantly improving our products, that is why the information, characteristics and availability of them can change without prior notice.

## JOBSITE BOXES



High strength steel hinges.



Heavy-duty handle.



Base has a hole to secure box to the floor if required.



Contoured bends on the lid prevent water entering caused by runoff.



Anti-theft security system keeps the padlock hidden and out of reach of a saw, drill, bolt cutter or pry bars.

• Heavy-duty 16-gauge steel frame with electrostatic paint finish for superior weather resistance.

### METAL JOBSITE BOXES



**1,323 LB**  
MAXIMUM CAPACITY

**60"**



JSB60

**1,102 LB**  
MAXIMUM CAPACITY

**48"**



JSB48

**661 LB**  
MAXIMUM CAPACITY

**36"**



JSB36

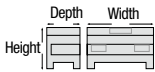

• Ideal for safe and organized storage of tools and equipment at work.

ITEM	JSB60	JSB48	JSB36
WIDTH	60"	48"	36"
DEPTH	24-7/32"	24-3/16"	17"
HEIGHT	28-11/32"	28-5/16"	21-5/16"
☞	1	1	1
AVAILABLE	On Request	On Request	On Request

### CASTER SET FOR JOBSITE BOXES



**1,764 LB**  
LOAD CAPACITY

**4**  
PIECES



• Supports up to 200 kg per wheel.  
• Includes 2 fixed wheels and 2 swivel wheels with brakes.



ITEM	DIMENSION	☞	AVAILABLE
JBREF1	5"	1	On Request

### METALLIC FOLD-OUT TOOLBOX

#### BLACK METAL FOLD-OUT TOOLBOX

**HEAVY DUTY** **24 STEEL GAUGE**

**55 LB**  
TOTAL LOAD CAPACITY

**5**  
TRAYS

**18"**



VIDEO



• Double lifting handles  
• Fold-out drawers for maximum space utilization.  
• Includes padlock hasps.

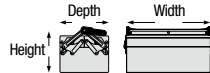

ITEM	CMA4
WIDTH	18"
DEPTH	7-7/8"
HEIGHT	7-3/4"
TOTAL LOAD CAPACITY	55 lb
☞	1
AVAILABLE	On Request

### RED METAL FOLD-OUT TOOLBOX



**24 STEEL GAUGE**

**44 LB**  
TOTAL LOAD CAPACITY

**5**  
TRAYS

**21"**



CMA3

**33 LB**  
TOTAL LOAD CAPACITY

**5**  
TRAYS

**16"**



CMA2

**33 LB**  
TOTAL LOAD CAPACITY

**3**  
TRAYS

**16"**



CMA1

• Fold-out drawers for maximum space utilization.  
• Includes padlock hasps.

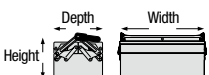

ITEM	CMA3	CMA2	CMA1
WIDTH	21-1/4"	16"	16"
DEPTH	7-7/8"	7-7/8"	7-7/8"
HEIGHT	8"	8"	6"
TOTAL LOAD CAPACITY	44 lb	33 lb	33 lb
☞	1	1	1
AVAILABLE	On Request	On Request	On Request



**SAFETY WATERPROOF TOOL BOXES**



# SAFETY WATERPROOF TOOL BOXES



Polyurethane foam designed to protect various materials and equipment.

## TOTAL PROTECTION

against impacts, vibration and shocks due to the polyurethane foam (1.09 lb / ft<sup>3</sup> (min)).



CPI16



Safety system for padlocks.



Purge valve for atmospheric pressure changes.

ORGANIZATION AND STORAGE

**SAFETY WATERPROOF PLASTIC TOOLBOXES**



**1,100 LB** MAXIMUM CAPACITY



• Polyurethane foam designed to protect various materials and equipment.



• Safety system for padlocks.



• Purge valve for atmospheric pressure changes.



VIDEO

**24"**



CPI24R  
With wheels

**20"**



CPI20

**16"**



CPI16

**10"**



CPI10

**9"**



CPI9

• Full protection against impacts, vibrations, and shocks thanks to high-density polyurethane foam.

ITEM	CPI24R	CPI20	CPI16	CPI10	CPI9
WIDTH	24"	20"	16"	10"	9"
DEPTH	19"	16"	12"	9"	7"
HEIGHT	9"	8"	6"	6"	4"
STORAGE CAPACITY	67 L / 17.7 gal	42 L / 11.1 gal	19 L / 5 gal	9 L / 2.4 gal	4 L / 1.1 gal
☑	1	1	1	1	1
AVAILABLE	On Request	On Request	On Request	On Request	On Request

**METAL TOOL BOXES**

**BLACK METAL TOOLBOXES**



**20 STEEL GAUGE**



VIDEO

**26"**



D9C20

**24"**



D8C20

**25"**



D7C20

**20"**



D6C20

**18"**



D4C20

**16"**



D3C20

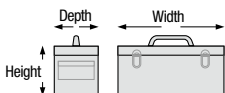

- Durable electrostatic paint provides excellent resistance to rust and abrasion.
- Chrome-plated metal safety clasps with padlock hasps.
- Includes metal organizer tray.

ITEM	D9C20	D8C20	D7C20	D6C20	D4C20	D3C20
WIDTH	26"	23-3/4"	24-5/8"	20-1/16"	17-15/16"	16-1/8"
DEPTH	8-5/8"	10"	9-5/8"	8-7/16"	7-11/16"	7-5/16"
HEIGHT	9"	11-1/8"	9-5/8"	9-7/16"	7-11/16"	7-1/2"
STORAGE CAPACITY	33 L / 8.7 gal	43 L / 11.4 gal	37 L / 9.8 gal	26 L / 6.9 gal	17 L / 4.5 gal	14 L / 3.7 gal
☑	1	1	1	1	1	1
AVAILABLE	✓	✓	On Request	✓	✓	On Request

## METAL TOOL BOXES

### RED METAL TOOLBOXES WITH PLASTIC HANDLE



D8



D7



D6



D5



D4



D3



D2



D1

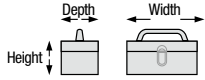

• High-resistance PVC plastic handle.

- Chrome plated metallic latches.
- Deep side slots for easy handling.
- Central clasp for padlock design.
- Metallic tray included.
- Durable electrostatic paint ensures resistance to rust and abrasion.
- Full-width piano hinge.

ITEM	D8	D7	D6	D5	D4	D3	D2	D1
WIDTH	23-3/4"	24-5/8"	20-1/16"	20-1/16"	17-15/16"	16-1/8"	14-3/16"	11-13/16"
DEPTH	10"	9-5/8"	8-7/16"	7-7/8"	7-11/16"	7-5/16"	6-5/16"	6-5/16"
HEIGHT	11-1/8"	9-5/8"	9-7/16"	7-7/8"	7-11/16"	7-1/2"	6-7/8"	5-11/16"
STORAGE CAPACITY	43 L / 11.4 gal	37 L / 9.8 gal	26 L / 6.9 gal	29 L / 7.7 gal	17 L / 4.5 gal	14 L / 3.7 gal	10 L / 2.6 gal	7 L / 1.8 gal
☑	1	1	1	1	1	1	1	1
AVAILABLE	✓	On Request	✓	On Request	✓	✓	On Request	On Request

### YELLOW AND GRAY METAL TOOLBOXES WITH DRAWERS



NEW

3 DRAWERS  
18"



125111

CM3G

2 DRAWERS  
19"



125107

CM2G

Yellow 125111  
125107  
Gray CM3G  
CM2G

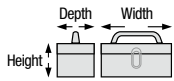

- Heat-cured electrostatic powder coating provides excellent wear resistance.
- Metal safety latches.
- Padlock-ready security hasp.
- Ergonomic plastic handle.
- Easy-access top drawer.

ITEM	125111	CM3G	125107	CM2G
WIDTH	18"	18"	18-1/2"	18-1/2"
DEPTH	11-3/4"	11-3/4"	9-7/16"	9-7/16"
HEIGHT	9"	9"	11"	11"
STORAGE CAPACITY	31 L / 8.2 gal	31 L / 8.2 gal	31 L / 8.2 gal	31 L / 8.2 gal
☑	1	1	1	1
AVAILABLE	✓	On Request	✓	On Request

### YELLOW AND GRAY METAL TOOLBOXES WITH TRAY



NEW

16"



CM16

CM16G

Yellow CM24  
CM20  
CM16  
Gray CM24G  
CM20G  
CM16G

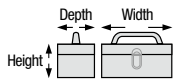

- Includes organizing tray.
- Heat-cured electrostatic powder coating for wear resistance.
- Metal safety latches.
- Padlock-compatible security hasp.
- Durable plastic handle.

ITEM	CM24	CM24G	CM20	CM20G	CM16	CM16G
WIDTH	23-7/8"	23-7/8"	19-7/8"	19-7/8"	16"	16"
DEPTH	9-3/16"	9-3/16"	7-3/16"	7-3/16"	7-3/16"	7-3/16"
HEIGHT	7-1/2"	7-1/2"	6-7/16"	6-7/16"	6-7/16"	6-7/16"
STORAGE CAPACITY	27 L / 23 gal	27 L / 23 gal	27 L / 23 gal	27 L / 23 gal	12 L / 3.170 gal	12 L / 3.170 gal
☑	1	1	1	1	1	1
AVAILABLE	✓	✓	✓	✓	✓	✓

### YELLOW METAL TOOLBOXES WITHOUT TRAY



NEW

14"



TB08

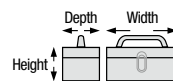

- Heat-cured electrostatic powder coating provides excellent wear resistance.
- Metal safety latches.
- Durable plastic handle.

ITEM	TB12	TB08	TB09
WIDTH	17"	14-3/16"	9-13/16"
DEPTH	6-1/4"	6-1/4"	5-3/4"
HEIGHT	6-1/4"	6"	6"
STORAGE CAPACITY	11 L / 3 gal	9 L / 2 gal	5.55 L / 1.5 gal
☑	1	1	1
AVAILABLE	On Request	On Request	On Request

**METAL TOOL BOXES**

**RED GENERAL-PURPOSE METAL BOXES**

**INDUSTRIAL DUTY** **24 STEEL GAUGE**



ORGANIZATION AND STORAGE



- Weather-resistant electrostatic powder coating designed for extreme conditions.
- Durable plastic handle.



ITEM	5896	5696	5495	5493	5496	5396	4725	4019
DESCRIPTION	-	-	-	-	-	-	-	For pullers
WIDTH	35-1/8"	23-1/2"	19-1/2"	17-15/16"	18-3/4"	115"	9-11/16"	12-5/8"
DEPTH	11-3/4"	9-1/16"	8-11/16"	4-3/4"	5-15/16"	6-11/16"	4-15/16"	11-13/16"
HEIGHT	4-7/8"	3-1/2"	1-15/16"	4-3/4"	3-9/16"	2-5/32"	1-3/8"	2-3/16"
STORAGE CAPACITY	32 L / 8.5 gal	12 L / 3.2 gal	5 L / 1.3 gal	6.5 L / 1.7 gal	6 L / 1.6 gal	3.5 L / 0.9 gal	1 L / 0.3 gal	5 L / 1.3 gal
☞	1	1	1	1	1	1	1	1
AVAILABLE	✓	✓	✓	✓	✓	✓	✓	✓

**MODULAR PLASTIC TOOLBOXES**

**SUPER DUTY** **MODULAR DESIGN** **IP66 PROTECTION**

**MODULAR TOOL BOXES**

**COMPATIBLE** with the Urrea Modular Storage System.

- Mobile separators.
- Polyamide clips and connectors.
- Graduated cover.
- Transparent polycarbonate cover.
- Reinforced design.
- Mobile separators.
- Aluminum handle.

**MODULAR PLASTIC TOOLBOXES WITH COMPARTMENTS**

**SUPER DUTY** **MODULAR DESIGN** **IP66 PROTECTION** **110 LB TOTAL LOAD CAPACITY**



**23" WIDTH**

**27" HEIGHT**

**16" HEIGHT**

**12" HEIGHT**

**7" HEIGHT**

- Mobile separators.
- Graduated cover.
- Transparent polycarbonate cover.
- Polyamide clips and connectors.
- Reinforced design.
- Compatible with the Urrea Modular Storage System.

ITEM	CPM27	CPM16	CPM12	CPM7
WIDTH	23"	23"	23"	23"
DEPTH	18"	15"	15"	15"
HEIGHT	27"	16"	12"	7"
STORAGE CAPACITY	50 L / 13.2 gal	52 L / 13.7 gal	38 L / 10 gal	15.4 L / 4 gal
☞	1	1	1	1
AVAILABLE	✓	On Request	✓	✓

## MODULAR PLASTIC TOOLBOXES

### MODULAR PLASTIC ORGANIZER BOXES



• Transparent polycarbonate cover.



• Polyamide clips and connectors.



• Mobile separators.



• Reinforced design.

URREA



**92 LB**  
TOTAL LOAD CAPACITY

**23"**



CPOR23

**83 LB**  
TOTAL LOAD CAPACITY

**21"**



CPOR21

**26 LB**  
TOTAL LOAD CAPACITY

**10"**



CPOR10



ITEM	CPOR23	CPOR21	CPOR10
WIDTH	23"	21"	10"
DEPTH	15"	14"	14"
HEIGHT	5"	3"	3"
STORAGE CAPACITY	13.5 L / 3.57 gal	6 L / 1.6 gal	2.5 L / 0.66 gal
☒	1	1	1
AVAILABLE	✓	✓	On Request

### PLASTIC MODULAR TOOL BOXES WITH ORGANIZER COMPARTMENTS



• Mobile separators.



• Aluminum handle.



• Reinforced design.



• Modular storage system.

URREA



**132 LB**  
TOTAL LOAD CAPACITY

**25"**



CP025

**132 LB**  
TOTAL LOAD CAPACITY

**21"**



CP021

**110 LB**  
TOTAL LOAD CAPACITY

**18"**



CP018



ITEM	CP025	CP021	CP018
WIDTH	25"	21"	18"
DEPTH	10"	10"	10"
HEIGHT	10"	9"	9"
STORAGE CAPACITY	29 L / 7.7 gal	22 L / 5.8 gal	14 L / 3.7 gal
☒	1	1	1
AVAILABLE	On Request	On Request	✓

### MODULAR TOOLBOXES ACCESSORIES



• Reinforced design.



• Modular storage system.



• Modular storage system.

URREA



**110 LB**  
TOTAL LOAD CAPACITY

**22"**



CPS9

**220 LB**  
MAX. STAKING CAPACITY

**29"**



PTMOV

Modular plastic box with dividers		Modular mobile platform	
ITEM	CPS9	ITEM	PTMOV
WIDTH	22"	WIDTH	29"
DEPTH	14"	DEPTH	20"
HEIGHT	9"	HEIGHT	7"
STORAGE CAPACITY	35 L / 9.2 gal	STAKING CAPACITY	100 kg / 220 lb
☒	1	☒	1
AVAILABLE	✓	AVAILABLE	✓

**PLASTIC TOOL BOXES**

**RED AND BLACK METAL-PLASTIC TOOLBOXES**

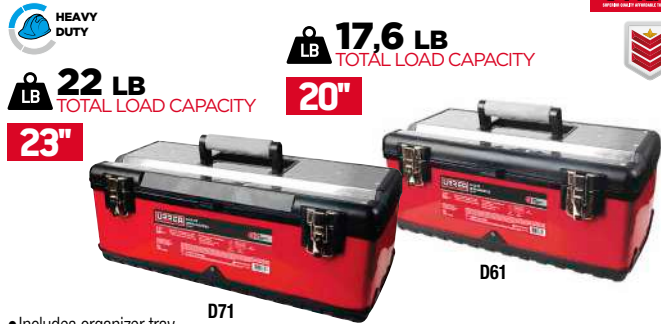

- Includes organizer tray.
- Durable 25-gauge sheet steel construction.
- Ergonomic plastic handle for improved grip.
- Metal latches and padlock hole for added security.
- Spacious steel body to store more tools.
- Multi-purpose "V" groove on the lid, ideal for holding pipes or profiles during cutting.

ITEM	D71	D61
WIDTH	23"	20"
DEPTH	11"	11"
HEIGHT	8-5/8"	8-5/8"
STORAGE CAPACITY	36 L / 9.5 gal	31 L / 8.2 gal
☑	1	1
AVAILABLE	On Request	On Request

**METAL-PLASTIC TOOLBOXES 99 SERIES**



- Includes tray.
- Strategic corner reinforcements.
- High-resistance metal latches.
- Made from high-resistance polyurethane.

ITEM	9921	9920
WIDTH	25"	20"
DEPTH	11"	11"
HEIGHT	10-1/2"	10-1/2"
STORAGE CAPACITY	23 L / 6.1 gal	19 L / 5 gal
☑	1	1
AVAILABLE	On Request	On Request

**PLASTIC TOOL BOXES WITH METAL LATCHES**



- Side-handle body design.



- Side-handle body design.



- Compact design fits tight spaces, with enough length to store long-handled tools.

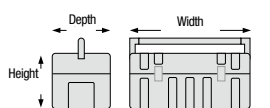

- High-strength metal latches with padlock hasps.
- 110° lid opening for easy access.
- Reinforced ribbed design and metal handle for added durability.
- Full-length hinge for extended service life.

ITEM	CPU26AR	CPU26A	CPU20AR	CPU20A	CPU20	CPUC20R	CPUC20	CPU17AR	CPU17A	CPU17
LID COLOR	Red	Black	Red	Black	Black	Red	Black	Red	Black	Black
WITH TRAY	•	•	•	•	-	-	-	•	•	-
WIDTH	26"	26"	21"	21"	21"	21"	21"	17"	17"	17"
DEPTH	10-3/4"	10-3/4"	10-3/4"	10-3/4"	10-3/4"	10-3/4"	10-3/4"	9-1/2"	9-1/2"	9-1/2"
HEIGHT	10-1/2"	10-1/2"	10-1/2"	10-1/2"	10-1/2"	7-1/2"	7-1/2"	8-1/2"	8-1/2"	8-1/2"
COMPACT						•	•			
STORAGE CAPACITY	41 L / 10.8 gal	41 L / 10.8 gal	31.5 L / 8.3 gal	31.5 L / 8.3 gal	31.5 L / 8.3 gal	22 L / 5.8 gal	22 L / 5.8 gal	15 L / 4.0 gal	15 L / 4.0 gal	15 L / 4.0 gal
☑	1	1	1	1	1	1	1	1	1	1
AVAILABLE	On Request	✓	✓	✓	✓	✓	✓	✓	✓	✓

## PLASTIC TOOL BOXES

ORGANIZATION AND STORAGE

### DISPLAY DISPENSERS FOR PLASTIC BOXES



**8**  
PIECES  
CPS20E

**10**  
PIECES  
CPSC20E



CPS20E

- Pre-cut box designed for use as dispenser.
- Includes label holder for front panel.

ITEM	DESCRIPTION	☐	AVAILABLE
CPS20E	8 tool boxes per display box	1	✓
CPSC20E	10 tool boxes per display box	1	On Request

### PLASTIC TOOLBOXES SET



**6**  
PIECES  
20"



CPS6C

**2**  
PIECES  
21"  
17"



CPS2C

ITEM	CPS6C		CPS2C	
CONTENT				
	125074	x 1	CPSC20	x 1
	GAVA1	x 4	CPSC17	x 1
	GAVPIN	x 1 (bag with 12 pieces)		
		1		1
☐ AVAILABLE	On Request			✓

### PLASTIC TOOLBOXES WITH METAL LATCHES



**88 LB**  
TOTAL LOAD CAPACITY

**26"**



CPS26

- Tray with 7 divisions.

**21"**



CPS20

- Tray with 7 divisions.

**21"**  
COMPACT



CPSC20

- Suitable for storing long-handled tools.
- Plastic tray is not included.

**17"**



CPS17

- Tray with 6 divisions.



CPS17K

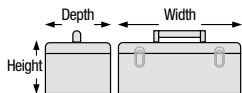

- High-strength plastic with reinforced body.
- Metal clasps with padlock hasps.
- Integrated side handles for easy carrying.
- Lid opens 110° for easy access.
- Durable long-life hinge.
- Non-slip lid supports standing.

ITEM	CPS26	CPS20	CPSC20	CPS17	CPS17K
WIDTH	26"	21"	21"	17"	17"
DEPTH	10-3/4"	10-3/4"	10-3/4"	9-1/2"	9-1/2"
HEIGHT	10-1/2"	10-1/2"	7-1/2"	8-1/2"	8-1/2"
COMPACT			•		
STORAGE CAPACITY	39 L / 10.3 gal	31.5 L / 8.3 gal	22 L / 5.8 gal	15 L / 4.0 gal	15 L / 4.0 gal
☐ AVAILABLE	1	1	1	1	1
AVAILABLE	✓	✓	✓	✓	✓

**BULK**



**PLASTIC TOOL BOXES**

**PLASTIC TOOLBOX WITH PLASTIC LATCHES AND TRAY**

**INDUSTRIAL DUTY**  
**99 LB**  
 TOTAL LOAD CAPACITY

**19"**



**URRERA**  
 MADE FOR PROFESSIONALS

**NEW**

VIDEO

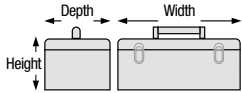

- 100% virgin plastic lid; durable post-industrial plastic body.
- Full-length hinge for long-lasting use.
- Metal-free design.
- Tray with 8 compartments.
- Includes padlock hasp.

**BULK**

ITEM	CPU19P
WIDTH	19"
DEPTH	10 1/2"
HEIGHT	10"
STORAGE CAPACITY	23 L / 6.1 gal
☞	1
AVAILABLE	✓

**PLASTIC TOOLBOXES SET WITH LATCHES AND TRAY**

**INDUSTRIAL DUTY**

**15**  
PIECES



**URRERA**  
 MADE FOR PROFESSIONALS

**NEW**

• Stackable presentation for efficient shipping and storage.

ITEM	CONTENT	WIDTH	DEPTH	HEIGHT	☞	AVAILABLE
CPU19T	15	43-5/16"	22-3/16"	24-7/16"	1	✓

**PLASTIC TOOLBOX WITH PLASTIC LATCHES AND TRAY**

**PROFESSIONAL USE**  
**88 LB**  
 TOTAL LOAD CAPACITY

**19"**



**SURTEK**  
 MADE FOR PROFESSIONALS

**NEW**

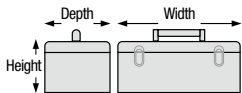

- Durable post-industrial plastic body.
- Full-length hinge for long-lasting use.
- Metal-free design.
- Tray with 8 compartments.
- Includes padlock hasp.

**BULK**

ITEM	CPS19P
WIDTH	19"
DEPTH	10-1/2"
HEIGHT	10"
STORAGE CAPACITY	23 L / 6.1 gal
☞	1
AVAILABLE	✓

**PLASTIC TOOLBOXES SET WITH PLASTIC LATCHES AND TRAY**

**PROFESSIONAL USE**

**15**  
PIECES



**SURTEK**  
 MADE FOR PROFESSIONALS

**NEW**

• Stackable presentation for efficient shipping and storage.

ITEM	CONTENT	WIDTH	DEPTH	HEIGHT	☞	AVAILABLE
CPS19T1	15	43-5/16"	22-3/16"	24-7/16"	1	On Request

**BLACK PLASTIC TOOLBOX WITH PLASTIC LATCHES**

**GENERAL USE**  
**66 LB**  
 TOTAL LOAD CAPACITY

**19"**



**SURTEK**  
 MADE FOR PROFESSIONALS

**NEW**

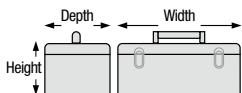

- Medium resistance plastic body.
- Full-length hinge for long-lasting use.
- Metal-free design.
- Includes padlock hasp.

**BULK**

ITEM	CPS19NP
WIDTH	19"
DEPTH	10-1/2"
HEIGHT	10"
STORAGE CAPACITY	23 L / 6.1 gal
☞	1
AVAILABLE	On Request

**SET BLACK PLASTIC TOOLBOXES WITH PLASTIC LATCHES**

**GENERAL USE**

**15**  
PIECES



**SURTEK**  
 MADE FOR PROFESSIONALS

**NEW**

• Stackable presentation for efficient shipping and storage.

ITEM	CONTENT	WIDTH	DEPTH	HEIGHT	☞	AVAILABLE
CPS19NT	15	43-5/16"	22-3/16"	24-7/16"	1	On Request

## PLASTIC TOOL BOXES

# STACKING PLASTIC BINS



Rear tab for rails.



Side locks for assembling blocks and structures with enhanced stability and security.



Front slot for label holder.

### SPACE SAVING



Stackable units with internal rails for two stacking configurations. Compatible with the previous design.

### EXTENSION POLE



GAVPIN

Provides an additional 2" space between drawers

Facilitates drawer stacking while keeping work area clear.

## VERSATILE SOLUTION

Practical for handling, storage, and organization of all types of parts.

## PLASTIC STACKING BINS

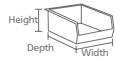
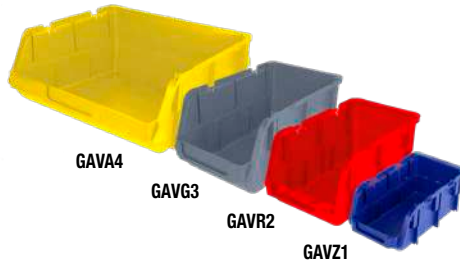

• Made from high-strength polypropylene.

ITEM	GAVA1	GAVA2	GAVA3	GAVA4	GAVZ1	GAVZ2	GAVZ3	GAVZ4	GAVG1	GAVG2	GAVG3	GAVG4
LOAD CAPACITY	6.6 lb	15.4 lb	33.1 lb	55.1 lb	6.6 lb	15.4 lb	33.1 lb	55.1 lb	6.6 lb	15.4 lb	33.1 lb	55.1 lb
COLOR	[Color swatches]											
DEPTH	7-1/2"	11"	14-1/2"	17"	7-1/2"	11"	14-1/2"	17"	7-1/2"	11"	14-1/2"	17"
HEIGHT	3"	5"	6-1/2"	7"	3"	5"	6-1/2"	7"	3"	5"	6-1/2"	7"
WIDTH	4"	6-1/2"	8-1/2"	16-1/2"	4"	6-1/2"	8-1/2"	16-1/2"	4"	6-1/2"	8-1/2"	16-1/2"
☞	12	4	3	3	12	4	3	3	12	4	3	3
AVAILABLE	On Request	On Request	On Request	On Request	✓	✓	✓	✓	✓	✓	✓	✓

ITEM	GAVR1	GAVR2	GAVR3	GAVR4	GAVV1	GAVV2	GAVV3	GAVV4	GAVN1	GAVN2	GAVN3	GAVN4
LOAD CAPACITY	55.1 lb	15.4 lb	33.1 lb	55.1 lb	6.6 lb	15.4 lb	33.1 lb	55.1 lb	6.6 lb	6.6 lb	33.1 lb	55.1 lb
COLOR	[Color swatches]											
DEPTH	7-1/2"	11"	14-1/2"	17"	7-1/2"	11"	14-1/2"	17"	7-1/2"	11"	14-1/2"	17"
HEIGHT	3"	5"	6-1/2"	7"	3"	5"	6-1/2"	7"	3"	5"	6-1/2"	7"
WIDTH	4"	6-1/2"	8-1/2"	16-1/2"	4"	6-1/2"	8-1/2"	16-1/2"	4"	6-1/2"	8-1/2"	16-1/2"
☞	12	4	3	3	12	4	3	3	12	4	3	3
AVAILABLE	✓	✓	On Request	On Request	✓	✓	✓	✓	✓	On Request	On Request	On Request

## EXTENSION POLE FOR STACKING BINS



NEW



GAVPIN

- Compatible with all drawer models.
- Extension pole suggested to be used at half of load capacity
- Patented design by Grupo Urrea.

BULK

ITEM	GAVPIN
DESCRIPTION	Extension pole
☞	12
AVAILABLE	✓

## METAL UTILITY CARTS



### METAL UTILITY CART WITH DRAWERS



**88 LB**  
TOTAL LOAD CAPACITY

**22 STEEL GAUGE**

**30"**

**5 DRAWERS**

21-1/8"

20"

30"



Ball-bearing drawer slides.

Four 5" x 2" casters.

Push handles both sides.

ITEM	DRAWERS	WIDTH	DEPTH	HEIGHT	☞	AVAILABLE
X30U5	2	17-11/16"	11-5/8"	2-3/8"	1	On Request
	1	17-11/16"	11-5/8"	5"		
	1	24-5/8"	17-11/16"	3-1/8"		
	1	24-5/8"	17-11/16"	5"		
	1	23-3/16"	11"	4"		

### TOOL UTILITY 4 LEVELS FOLDING CART



**22 STEEL GAUGE**

**27"**

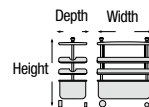

- Collapsible to a height of 19".
- Exclusive design allowing easy storage of cabinet.
- Chromed poles offer better esthetics and easier sliding of the top trays.
- Large strong bin for placing tools from the top compartments when collapsing it to put away.
- The swivel casters feature brakes that are applied with the foot.
- Rubber casters featuring a double ball bearing rolling system, including dust and lint protectors.



ITEM	WIDTH	DEPTH	HEIGHT	☞	AVAILABLE
9982	27-1/2"	15-3/4"	35-7/16"	1	On Request

**METAL UTILITY CARTS**

**METAL UTILITY CART WITH DRAWER**

**HEAVY DUTY** **485 LB** **TOTAL LOAD CAPACITY** **BALL BEARING** **DRAWER SLIDES**

**30"** **22 STEEL GAUGE**

**1** **DRAWERS**

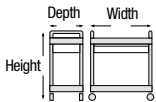

ITEM	WIDTH	DEPTH	HEIGHT	☑	AVAILABLE
9983	30"	16"	35"	1	On Request

**METAL UTILITY CART WITH COMPARTMENT**

**INDUSTRIAL DUTY** **485 LB** **TOTAL LOAD CAPACITY**

**33"**

**1** **DRAWERS**

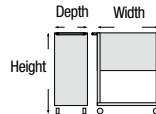

ITEM	WIDTH	DEPTH	HEIGHT	☑	AVAILABLE
9981	33-1/4"	17-3/4"	37-9/16"	1	✓

**METAL UTILITY CART WITH COMPARTMENT**

**INDUSTRIAL DUTY** **485 LB** **TOTAL LOAD CAPACITY** **22 STEEL GAUGE**

**30"**

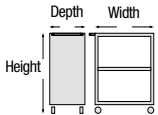

- Double shelf.
- 22 gauge sheet steel for frame.

ITEM	WIDTH	DEPTH	HEIGHT	☑	AVAILABLE
9980	30"	18"	38-1/2"	1	On Request

**METAL UTILITY CART WITH SHELVES**

**INDUSTRIAL DUTY** **485 LB** **TOTAL LOAD CAPACITY** **22 STEEL GAUGE**

**30"**

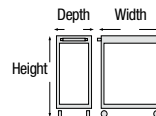

ITEM	WIDTH	DEPTH	HEIGHT	☑	AVAILABLE
44180	30"	16"	35"	1	On Request

**METAL UTILITY CART WITH DOUBLE SHELF**

**PROFESSIONAL USE** **24 STEEL GAUGE** **176 LB** **TOTAL LOAD CAPACITY**

**25"**



<span style="color: yellow;">●</span> Yellow	<span style="color: gray;">●</span> Gray
125108	CU2G

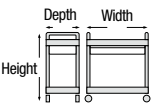

- Thermoset electrostatic paint.

ITEM	WIDTH	DEPTH	HEIGHT	☑	AVAILABLE
125108	25-3/16"	16-17/32"	32-11/16"	1	✓
CU2G	25-3/16"	16-17/32"	32-11/16"	1	On Request

**WIRE UTILITY CARTS**

**WIRE UTILITY CARTS WITH SHELVES**

**INDUSTRIAL DUTY** **992 lb** **TOTAL LOAD CAPACITY** **ADJUSTABLE HEIGHT** **NSF**



- 5" Polyurethane casters, 2 with brakes.

- Adjustable height of the shelves in increments of 1".
- Easy and quick assembly.
- No tool required.
- Chrome finish.
- Available accessories, sold separately.

ITEM	44185
WIDTH	36"
HEIGHT	18"
DEPTH	41"
SHELVES	2
☑	1
AVAILABLE	On Request



44185



## PLASTIC UTILITY CART

### PLASTIC UTILITY CART WITH SHELVES

**INDUSTRIAL DUTY**  
**397 LB**  
 TOTAL LOAD CAPACITY

**35"**

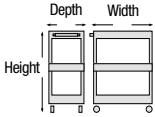

- Made of high-density polyethylene.
- Resistant to solvents, petroleum liquids, and battery acid.
- TPR-covered wheels for smooth, durable handling.



ITEM	WIDTH	DEPTH	HEIGHT	☐	AVAILABLE
9980P	35-1/4"	18"	36-1/4"	1	✓

## DOUBLE-ARM UTILITY HOOKS

### DOUBLE-ARM UTILITY HOOKS

**GENERAL USE** **CARBON STEEL**  
**66 LB**  
 TOTAL LOAD CAPACITY



- Made out of carbon steel with an electrostatic powder-coated finish.
- PVC covering to protect items from damage.
- Easy to install.



ITEM	WIDTH	HEIGHT	LOAD CAPACITY	☐	AVAILABLE
GMU10	3-15/16"	5-1/2"	5-1/2"	1	✓
GMU13	5-1/8"	5-1/2"	66.1 lb	1	✓
GMU18	7-1/16"	6-1/2"	66.1 lb	1	✓

## FIXED STEEL WORKBENCHES

**INDUSTRIAL DUTY**

**BALL BEARING DRAWER SLIDES**



Tubular high security lock and key.



Large surface for more work space.



Lower shelf for more storage capacity.

Sheet Thickness:  
 Frame: 2 mm = 5/64"  
 Cover: 2 mm = 5/64"  
 Drawer: 18 gauge

### STEEL WORKBENCH WITH DRAWERS – H SERIE

**INDUSTRIAL DUTY**  
**1,323 LB**  
 MAXIMUM CAPACITY **77 LB**  
 DRAWER LOAD CAPACITY

**BALL BEARING DRAWER SLIDES**



**59"**  
**2**  
 DRAWERS

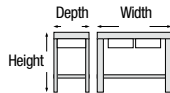

- 14 gauge sheet steel for frame.
- 2 drawers with ball-bearing system.

ITEM	WIDTH	DEPTH	HEIGHT	☐	AVAILABLE
I59W2	59"	25-1/2"	34-3/4"	1	On Request



**INDUSTRIAL DUTY**



Extended edge around table cover.



Large surface for more work space.



Lower shelf for more storage capacity.

Sheet Thickness:  
 Frame: 2 mm  
 Cover: 2 mm

### STEEL WORKBENCH – H SERIES

**INDUSTRIAL DUTY**  
**882 LB**  
 TOTAL LOAD CAPACITY



**59"**

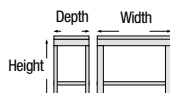

- 14 gauge sheet steel for frame.

ITEM	WIDTH	DEPTH	HEIGHT	☐	AVAILABLE
I59W	59"	27-1/2"	37"	1	On Request



# MODULAR CABINET SETUP.

CUSTOMIZE AREA TO SUIT YOUR NEEDS.



X35G2

35" wide cabinet with 2 adjustable shelves each 1-31/32" with large storage capacity ranging from components to work tools. Compatible with XGAC2 and XGAC1 drawers.

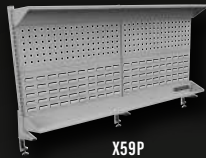

X59P

Easy installation panel for 59" fixed workstation with perforated and slotted sections for better use of work space as well as storage.



X35G4

35" wide cabinet with 4 adjustable shelves each 1-31/32" with large storage capacity ranging from components to work tools. Compatible with XGAC2 and XGAC1 drawers.

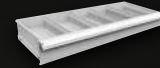

XGAC1

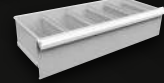

XGAC2



X35F4



X35F7

Fixed 35" wide cabinet with 7 drawers with Antitrollover/tipping system and separators for better organization. 1,102 lb of load capacity and anti-tip base. It can be replaced by the X35F4 model with a single compartment.

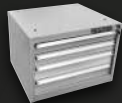

X22W4

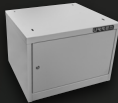

X22W1

Cabinet with 4 drawers with a high security block system and a large load capacity. It can be replaced by the X22W1 model with a single compartment.

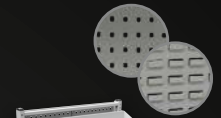

X35PM

34" multipurpose mobile panel with perforated and slotted section for better use of work space as well as storage.

CPOR10

CPOR21

CPOR23



## ORGANIZER BOXES

Compatible with the Urrea modular storage system.



X59WF

Fixed work station with a work surface of 12.1 ft<sup>2</sup>. Great gauge sheet steel and adjustable feet for better surface support.



CPM7



180 cm (70.86")

### SETTING EXAMPLES

	X35F7		X35F4	
FIXED CABINET				
HANGING CABINET	X22W4	X22W1	X22W4	X22W1
DRAWERS	11	8	8	5
COMPARTMENTS	-	1	-	1
MAXIMUM LOAD	5,975 lb	5,843 lb	5,975 lb	5,843 lb
LENGTH	10.83 ft			
WIDTH	2.46 ft			
HEIGHTS	5.9 ft			
HEIGHTS	8			



X35G4



X35G2

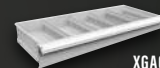

XGAC1

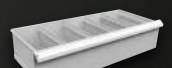

XGAC2

### MAXIMUM COMBINATIONS

CABINETS	XGAC1	XGAC2
X35G4	6	-
	5	1
	3	2
	1	3
X35G2	-	3
	2	-
	-	1
	1	1

## MODULAR FIXED CABINETS

ORGANIZATION AND STORAGE

**SUPER DUTY MODULAR DESIGN**



Security tubular locking system.



Concealed safety hook prevents drawers from being opened accidentally.



Bearing single rail.



Includes dividers to improve the organization.



Includes anti-tipping unit.

Sheet steel gauge:  
-Frame: 23 gauge.  
-Drawers: 22 gauge.

### FIXED MODULAR CABINET WITH DRAWERS – X SERIES

**SUPER DUTY** **165 LB** DRAWER LOAD CAPACITY

**35"**  
**7** DRAWERS

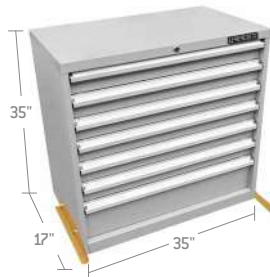

X35F7

Dimensions: 35" H, 17" D, 35" W

**SUPER DUTY** **165 LB** DRAWER LOAD CAPACITY

**35"**  
**4** DRAWERS



X35F4

Dimensions: 35" H, 17" D, 35" W

ITEM	DRAWERS	WIDTH	DEPTH	HEIGHT	⊞	AVAILABLE
X35F7	6	30-1/2"	13"	4"	1	On Request
X35F4	4	30-1/2"	13"	7-7/8"	1	On Request

**SUPER DUTY MODULAR DESIGN**



With double rod security system.



Adjustable shelves.



Sheet steel gauge:  
-Frame: 22 gauge.  
-Doors: 19 gauge.  
-Shelves: 22 gauge.

**SUPER DUTY MODULAR DESIGN**



Heavy-duty sliding rail.



Sheet steel gauge:  
-Drawers: 23 gauge.

### MODULAR STORAGE CABINET WITH SHELVES - X SERIES

**SUPER DUTY** **331 LB** SHELVES LOAD CAPACITY

**35"**  
**4** SHELVES



X35G4

Dimensions: 70-7/8" H, 17-11/16" D, 35-7/16" W

**SUPER DUTY** **331 LB** SHELVES LOAD CAPACITY

**35"**  
**2** SHELVES



X35G2

Dimensions: 35-7/16" H, 17-11/16" D, 35-7/16" W

ITEM	SHELVES	WIDTH	DEPTH	HEIGHT	⊞	AVAILABLE
X35G4	4	35-7/16"	17-11/16"	70-7/8"	1	On Request
X35G2	2	35-7/16"	17-11/16"	35-7/16"	1	On Request

### DRAWERS FOR MODULAR STORAGE CABINET WITH SHELVES - X SERIES

**SUPER DUTY** **165 LB** DRAWER LOAD CAPACITY

**30"**



XGAC2



XGAC1

• Easy to install in X35G4 and X35G2 cabinets.

Dimensions: 30" H, 17" D, 30" W

ITEM	XGAC2	XGAC1
WIDTH	30-1/2"	30-1/2"
DEPTH	13"	13"
HEIGHT	7-7/8"	4"
⊞	1	1
AVAILABLE	On Request	On Request

**SUPER DUTY MODULAR DESIGN**



Adjustable legs.



Large surface for more work space, board with a PVC coating.



Made of 16 gauge steel sheet.

### FIXED WORKSTATION – X SERIES

**SUPER DUTY** **2,205 LB** TOTAL LOAD CAPACITY

**59"**



X59WF

Dimensions: 59" W, 29-1/2" D, 39-3/8" H

ITEM	WIDTH	DEPTH	HEIGHT	⊞	AVAILABLE
X59WF	59"	29-1/2"	39-3/8"	1	On Request

**MODULAR FIXED CABINETS**

**SUPER DUTY MODULAR DESIGN**

Sheet steel gauge:  
-Panel: 16 gauge.  
-Shelves: 18 gauge.

Includes screw lever to ensure the panel to the work table.

Louvered steel panel for mounting bins.

CPM7

Square holes for hooks.

XGAL XGAD XGAT

**PANEL FOR FIXED WORKSTATION – X SERIES**

**SUPER DUTY** **661 LB** MAXIMUM CAPACITY **66 LB** SHELF LOAD CAPACITY

**59"**  
**2 SHELVES**

1-1/2" (38,1 mm)  
1-31/32" (80 mm)  
13-15" (21 mm)

Depth Width  
Height

ITEM	TOTAL LOAD CAPACITY	WIDTH	DEPTH	HEIGHT	AVAILABLE
X59P	661 lb	59"	8"	32-1/2"	1 On Request

**LONG HOOKS FOR SERIES X CABINETS**

**HEAVY DUTY**

XGAL XGAD XGAT

- Ideal for hanging brushes, hammers, pliers, and gardening tools.
- Made of stainless steel.
- Long hook for modular cabinets X59P and X35PM.
- Enhances and simplifies tool organization.

ITEM	WIDTH	DEPTH	HEIGHT	AVAILABLE
XGAL	6-5/16"	2-3/16"	2-3/8"	50 On Request
XGAD	6-5/16"	2-3/16"	2-3/8"	50 On Request
XGAT	6-1/2"	2-3/16"	2-3/8"	50 On Request

**SUPER DUTY MODULAR DESIGN**

Security tubular locking system.

Bearing single rail - design.

With mounting slots for assembly to X59WF table.

Sheet steel gauge:  
-Frame: 23 gauge.  
-Drawers: 22 gauge.

**HANGING CABINETS FOR FIXED WORKSTATION – X SERIES**

**SUPER DUTY** **88 LB** DRAWER LOAD CAPACITY

**22"**  
**4 DRAWERS**

17-23/32"  
22-13/16"  
22-1/4"

X22W4

Depth Width  
Height

• Triple sections bearing system.

**SUPER DUTY** **88 LB** DRAWER LOAD CAPACITY

**22"**  
**1 COMPARTMENT**

17-23/32"  
22-13/16"  
22-1/4"

X22W1

Depth Width  
Height

• They include accessories to assemble the X59WF table.

ITEM	DRAWERS	COMPARTMENT	WIDTH	DEPTH	HEIGHT	AVAILABLE
X22W4	2	-	18-5/32"	17-3/4"	3"	1 On Request
X22W1	-	1	18-5/32"	17-3/4"	4"	1 On Request

**SUPER DUTY MODULAR DESIGN**

Includes slotted panel with flanges.

Compatible hooks:  
XGAL  
XGAD  
XGAT

Compatible bins:  
CPOR10  
CPOR21  
CPOR23  
CPM7

2 fixed wheels 5" x 1-1/2"  
2 giratory wheels 5" x 1-1/2" with 360° rotation and brake.

Sheet steel gauge:  
-Panel: 16 gauge.  
-Top shelf: 18 gauge.  
-Middle and lower shelves: 20 gauges.

**MULTIPURPOSE MOVABLE PANEL – X SERIES**

**SUPER DUTY** **661 LB** MAXIMUM CAPACITY **44 LB** SHELF LOAD CAPACITY

**34"**  
**3 SHELVES**

1-1/2" (38,1 mm)  
1-31/32" (80 mm)  
13-15" (21 mm)

Depth Width  
Height

**URREA**

ITEM	TOTAL LOAD CAPACITY	WIDTH	DEPTH	HEIGHT	AVAILABLE
X35PM	661 lb	34-7/8"	25-9/16"	55-5/16"	1 On Request

## MODULAR FIXED CABINETS

ORGANIZATION AND STORAGE



- Double wall design structure.
- Anti-rollover/tipping system.
- Only one drawer can be opened at a time.
- Note: Only one drawer can be open at a time.



Cabinet drawers with sealed ball bearing drawer slides.



Full length individual secure per drawer.



Tubular high security locking key.



Slotted drawers on the sides of each drawer to facilitate placement of spacers.

### FIXED CABINETS WITH DRAWERS – X SERIES



**220 LB**  
DRAWER LOAD CAPACITY



**28"**  
**10**  
DRAWERS



X28F10

**28"**  
**9**  
DRAWERS



X28F9

**28"**  
**7**  
DRAWERS



X28F7

**28"**  
**6**  
DRAWERS



X28F6

**28"**  
**5**  
DRAWERS



X28F5

ITEM	X28F10			X28F9			X28F7			X28F6			X28F5		
DRAWERS	8	1	1	4	4	1	2	3	2	4	1	1	2	2	1
WIDTH	24"	24"	24"	24"	24"	24"	24"	24"	24"	24"	24"	24"	24"	24"	24"
DEPTH	24"	24"	24"	24"	24"	24"	24"	24"	24"	24"	24"	24"	24"	24"	24"
HEIGHT	3"	4"	7"	3"	4"	7"	3"	4"	6"	3"	6"	7"	3"	4"	10"
☑	1			1			1			1			1		
AVAILABLE	On Request			On Request			On Request			On Request			On Request		

### DRAWER SEPARATOR SETS - X SERIES



• Compatible with all Urrea fixed cabinets series X drawers.



**15**  
PIECES

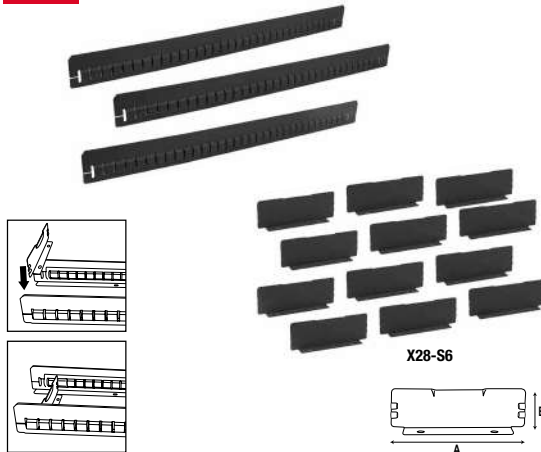

X28-S6

• Drawers can be organized with sections or groups of similar objects in the same compartment.

**BAG**

ITEM	DRAWER HEIGHT	LARGE SEPARATOR (IN)		SMALL SEPARATOR (IN)		☑	AVAILABLE
		A	B	A	B		
X28-S3	3"	23-15/16"	1-13/16"	5-7/8"	1-13/16"	1	On Request
X28-S4	4"	23-15/16"	2-13/16"	5-7/8"	2-13/16"	1	On Request
X28-S6	6"	23-15/16"	4-3/4"	5-7/8"	4-3/4"	1	On Request
X28-S8	8"	23-15/16"	6-3/4"	5-7/8"	6-3/4"	1	On Request
X28-S10	10"	23-15/16"	8-11/16"	5-7/8"	8-11/16"	1	On Request



Sheet Thickness:  
Structure: 3 mm  
Drawers: 1.5 mm



Plastic supports on the base help prevent structural damage and slipping.



Articulated cover to protect the drawers

Heavy-duty hinges and security bolts help avoid unforeseen closures.

### ON-SITE SERVICE CABINETS WITH DRAWERS



**794 LB**  
TOTAL LOAD CAPACITY



**661 LB**  
TOTAL LOAD CAPACITY



**66 LB**  
SHELF LOAD CAPACITY



**66 LB**  
SHELF LOAD CAPACITY

**30"**  
**7**  
DRAWERS



JSB307

**30"**  
**6**  
DRAWERS



JSB306

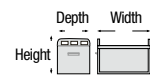

• Ideal for storing and organizing tools for transportation in trucks or vans in a secure manner.

ITEM	DRAWERS	WIDTH	DEPTH	HEIGHT	☑	AVAILABLE
JSB307	3	7"	16"	2-1/2"	1	On Request
	3	22"	16"	2-1/2"		
	1	22"	16"	6-1/2"		
JSB306	3	7"	16"	2-1/2"	1	On Request
	2	22"	16"	2-1/2"		
	1	22"	16"	6-1/2"		



## ROLLER CABINETS



Heavy-duty handles on top chest (M56S7).



Heavy-duty rubberized push handle (X56M8).



Full-length aluminium drawer pulls.



Ball-bearing drawer slides



Heavy-duty 6" x 2" roller bearing casters with 551 lb weight capacity per caster.



Full extension gas shock absorbers to facilitate opening and closing.



Tubular high security locking key.

M56M8 + M56S7



Sheet steel gauge:  
-Frame: 16 gauge  
-Drawers: 18 gauge

### ROLLER CABINET WITH DRAWERS – M SERIES



**99 LB**  
DRAWER LOAD CAPACITY



**56"**

**8**  
DRAWERS

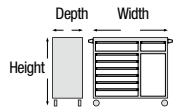

ITEM	DRAWERS	WIDTH	DEPTH	HEIGHT	☑	AVAILABLE
M56M8	1	29-1/4"	19-3/4"	6-1/4"		On Request
	1	19-7/8"	19-3/4"	6-1/4"	1	
	6	29-1/4"	19-3/4"	3-1/4"		

### TOP CHEST WITH DRAWERS – M SERIES



**99 LB**  
DRAWER LOAD CAPACITY



**56"**

**7**  
DRAWERS

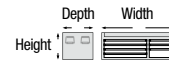

ITEM	DRAWERS	WIDTH	DEPTH	HEIGHT	☑	AVAILABLE
M56S7	4	29-1/4"	20"	2"		On Request
	2	18-1/2"	20"	2"	1	
	1	18-1/2"	20"	4"		



Sealed ball-bearing drawer slides



Heavy-duty tubular push handle.



Internal security system that secures the drawers.



Auto locking drawer system keeps drawers closed while in motion.



Heavy-duty 5" x 1-1/4" casters with 331 lb weight capacity per caster.

- Anti-rollover/tipping system.
- Only one drawer can be opened at a time.
- 5 dotted security locking key.
- Each drawer opens completely to find tools.

Sheet steel gauge:  
-Frame: 18 gauge.  
-Drawers: 20 gauge.

### ROLLER CABINETS WITH DRAWERS – MP SERIES



**220 LB**  
DRAWER LOAD CAPACITY



**220 LB**  
DRAWER LOAD CAPACITY



**28"**

**5**  
DRAWERS

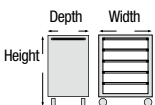

ITEM	DRAWERS	WIDTH	DEPTH	HEIGHT	☑	AVAILABLE
MP28M5	5	24"	17-23/32"	5-29/32"	1	On Request

**23"**

**4**  
DRAWERS

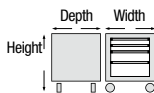

ITEM	DRAWERS	WIDTH	DEPTH	HEIGHT	☑	AVAILABLE
MP23M4	2	18"	17-11/16"	2-15/16"		On Request
	1	18"	17-11/16"	4-15/16"	1	
	1	18"	17-11/16"	6-7/8"		

## ROLLER CABINETS



Ball-bearing drawers slides.



Full-extension drawers for convenient tool access.



Heavy-duty tubular push handle.



Full length aluminium drawer pulls.



Internal security system that secures the drawers.



Heavy-duty 5" x 1/4" casters with 331 lb weight capacity per caster.

Sheer steel gauge:  
-Frame: 20 and 18 gauge.  
-Drawers: 22 gauge.

### ROLLER CABINETS WITH DRAWERS - EX SERIES



**77 LB**  
DRAWER LOAD CAPACITY

**27"**  
**6**  
DRAWERS

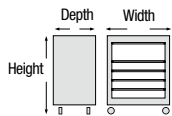

EX27M6



ITEM	DRAWERS	WIDTH	DEPTH	HEIGHT	☑	AVAILABLE
EX27M6	2	22-5/8"	14-13/16"	4"	1	✓
	4	22-5/8"	14-13/16"	6"		



**77 LB**  
DRAWER LOAD CAPACITY

**27"**  
**5**  
DRAWERS

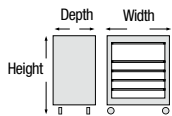

EX27M5



ITEM	DRAWERS	WIDTH	DEPTH	HEIGHT	☑	AVAILABLE
EX27M5	1	22-5/8"	14-13/16"	7-7/8"	1	✓
	4	22-5/8"	14-13/16"	4"		



### TOP CHEST WITH DRAWERS - EX SERIES



**55 LB**  
DRAWER LOAD CAPACITY

**27"**  
**6**  
DRAWERS

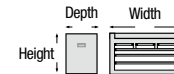

ITEM	DRAWERS	WIDTH	DEPTH	HEIGHT	☑	AVAILABLE
EX27S6	2	23"	11-13/16"	2-61/64"		
	1	23"	11-13/16"	2"	1	On Request
	3	7"	11-13/16"	2"		



Heavy-duty handles on top chest (X2713, X27S9, X27S4 and X41S8).



Heavy-duty rubberized push handle (X41S8, X41M11, X27M7 and X27M6).



Full-length aluminium drawer pulls.



Ball-bearing drawer slides.



Locking lid hinges on top chests.



Heavy-duty 5" x 2" casters with 331 lb weight capacity per caster.



Tubular high security lock and key.

Sheet steel gauge:  
-Frame: 19 gauge.  
-Drawers: 22 gauge.

### ROLLER CABINET WITH DRAWERS - X SERIES



**88 LB**  
DRAWER LOAD CAPACITY

**41"**  
**11**  
DRAWERS

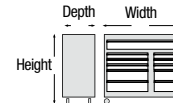

ITEM	DRAWERS	WIDTH	DEPTH	HEIGHT	☑	AVAILABLE
X41M11	1	37-3/4"	15-7/8"	5"		
	3	22-1/4"	15-7/8"	3"		
	2	22-1/4"	15-7/8"	6"	1	On Request
	3	12-1/4"	15-3/4"	3"		
	2	11-7/8"	15-7/8"	6"		



**ROLLER CABINETS**

**ROLLER CABINETS WITH DRAWERS – X SERIES**

**SUPER DUTY** **77 LB** DRAWER LOAD CAPACITY

**27"**  
**7**  
DRAWERS



**Red** **Blue** **Black**  
X27M7 X27M7A X27M7N

**SUPER DUTY** **77 LB** DRAWER LOAD CAPACITY

**27"**  
**6**  
DRAWERS



**Red** **Blue** **Black**  
X27M6 X27M6A X27M6N

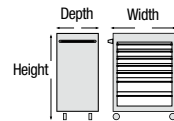
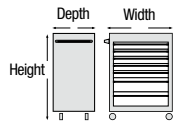

ITEM	DRAWERS	WIDTH	DEPTH	HEIGHT	⊞	AVAILABLE
X27M7	5	23-1/4"	14-3/4"	2"	1	On Request
	2	23-1/4"	14-3/4"	6"	1	On Request
X27M7A	5	23-1/4"	14-3/4"	2"	1	On Request
	2	23-1/4"	14-3/4"	6"	1	On Request
X27M7N	5	23-1/4"	14-3/4"	2"	1	On Request
	2	23-1/4"	14-3/4"	6"	1	On Request

ITEM	DRAWERS	WIDTH	DEPTH	HEIGHT	⊞	AVAILABLE
X27M6	5	23-1/4"	14-1/2"	2"	1	On Request
	1	23-1/4"	14-1/2"	6"	1	On Request
X27M6A	5	23-1/4"	14-1/2"	2"	1	On Request
	1	23-1/4"	14-1/2"	6"	1	On Request
X27M6N	5	23-1/4"	14-1/2"	2"	1	On Request
	1	23-1/4"	14-1/2"	6"	1	On Request

**TOP CHEST WITH DRAWERS – X SERIES**

**SUPER DUTY** **88 LB** DRAWER LOAD CAPACITY

**41"**  
**8**  
DRAWERS



**27"**  
**9**  
DRAWERS



**Red** **Blue** **Black**  
X27S9 X27S9A X27S9N

**SUPER DUTY** **77 LB** DRAWER LOAD CAPACITY

**27"**  
**4**  
DRAWERS



**Red** **Blue** **Black**  
X27S4 X27S4A X27S4N

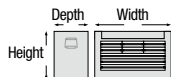
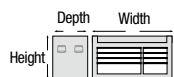

ITEM	DRAWERS	WIDTH	DEPTH	HEIGHT	⊞	AVAILABLE
X41S8	3	12-1/4"	15-3/4"	2-5/8"	1	On Request
	1	12-1/4"	15-3/4"	5-3/4"	1	On Request
	3	22-1/2"	15-3/4"	2-5/8"	1	On Request
	1	22-1/2"	15-3/4"	5-3/4"	1	On Request

ITEM	DRAWERS	WIDTH	DEPTH	HEIGHT	⊞	AVAILABLE
X27S9	9	7"	10"	2"	1	On Request
X27S9A	9	7"	10"	2"	1	On Request
X27S9N	9	7"	10"	2"	1	On Request
X27S4	4	22-3/4"	10"	6"	1	On Request
X27S4A	4	22-3/4"	10"	2"	1	On Request
X27S4N	4	22-3/4"	10"	2"	1	On Request

## ROLLER CABINETS

### INTERMEDIATE CHEST WITH DRAWERS – X SERIES

**77 LB** DRAWER LOAD CAPACITY

**27"**  
**3** DRAWERS

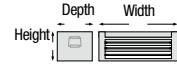

### CASTER SET FOR CABINETS – X SERIES

**243 LB** LOAD CAPACITY PER CASTER

**4** PIECES



- Wheels made of polypropylene (PP) with metal wheel axle.
- Includes nuts and screws for installation.
- 2 mobile casters with brakes.



ITEM	DRAWERS	WIDTH	DEPTH	HEIGHT	☐	AVAILABLE
X2713	2	22-3/4"	10"	2"	1	On Request
	1	22-3/4"	10"	2-1/2"		

ITEM	FOR MODELS				☐	AVAILABLE
RGRF1	X41M11	X27M7	X27M7A	X27M7N	1	On Request
		X27M7A	X27M7A	X27M7N		
		X27M7N	X27M7N	X27M7N		

### LOCKS AND KEYS FOR CABINETS



\*For M56M8 door.  
\*\*For M56M8 top drawer.



• All locks include a set of keys.

ITEM	GIRO	M56M8	M56S7	X41S8	X27S9	X27S4	H41S8	LOCK FOR H27S6	X41M11	X27M6	X27M7	H41M12	H27M6	H27M4	☐	AVAILABLE
CGREF1	90°	•*	•												1	On Request
CGREF2	90°			•											1	On Request
CGREF3	90°				•	•									1	On Request
CGREF4	90°						•								1	On Request
CGREF5	90°							•							1	On Request
CGREF6	180°	•**							•	•	•	•	•	•	1	On Request



Made of 430 grade stainless steel sheet (only exterior).

Sheet steel gauge:  
-Frame: 20 gauge.  
-Drawers: 22 gauge.

2 fixed casters.

2 mobile casters with brakes.

High resistance polyurethane caster wheels.

Tubular high security lock and key.

Large push handle for easy mobility.

Ball bearing drawer slides.

### STAINLESS STEEL ROLLER CABINET WITH DRAWERS - H SERIES

**55 LB** DRAWER LOAD CAPACITY

**27"**  
**7** DRAWERS

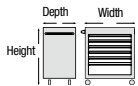

### STAINLESS STEEL TOP CHEST WITH DRAWERS – H SERIES

**55 LB** DRAWER LOAD CAPACITY

**27"**  
**7** DRAWERS

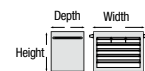

- Great resistance to corrosion.
- Easy to clean.
- With no outside coating, there is no risk of contamination or polluting particles.

• Recommended for industries that require higher standards, of cleanliness, especially food, beverage and pharmaceutical.

ITEM	DRAWERS	WIDTH	DEPTH	HEIGHT	☐	AVAILABLE
H27M7S	6	22-7/16"	16-1/8"	3-5/16"	1	✓
	1	22-7/16"	16-1/8"	6-11/16"		

ITEM	DRAWERS	WIDTH	DEPTH	HEIGHT	☐	AVAILABLE
H27S7S	3	6-11/16"	16-1/8"	2-1/8"	1	✓
	2	22-7/16"	16-1/8"	2-1/8"		
	2	22-7/16"	16-1/8"	3-5/16"		

## ROLLER CABINETS



**BALL BEARING DRAWER SLIDES**



Full-length aluminium drawer pulls.



Drawer rails with ball bearing slides on both sides.



Concave top area.



Perforated panels on the side.



High resistance polyurethane caster wheels (one with brake).



Corner protections against shocks.



Automatic closing system.



Corrosion resistant epoxy paint.

Sheet steel gauge:  
-Frame: 21 gauge.  
-Side panel: 23 gauge.

-Drawers: 22 gauge.  
-Frame: 21 gauge.

### ROLLER CABINETS WITH DRAWERS - HD SERIES



**55 LB DRAWER LOAD CAPACITY**

**38"**

**8 DRAWERS**



**55 LB DRAWER LOAD CAPACITY**

**35"**

**8 DRAWERS**



**55 LB DRAWER LOAD CAPACITY**

**28"**

**6 DRAWERS**



**55 LB DRAWER LOAD CAPACITY**

**28"**

**4 DRAWERS**

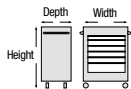

ITEM	DRAWERS	COMPARTMENT	WIDTH	DEPTH	HEIGHT	🔒	AVAILABLE
HD38M8	6	-	21"	15-3/4"	2-5/32"		On Request
	2	-	21"	15-3/4"	5"	1	
	-	1	8-3/4"	17-1/2"	27-1/2"		
HD35M8	6	-	27"	15-3/4"	2-5/32"	1	On Request
	2	-	27"	15-3/4"	5"		

ITEM	DRAWERS	COMPARTMENT	WIDTH	DEPTH	HEIGHT	🔒	AVAILABLE
HD28M6	3	-	21"	15-3/4"	2-5/32"		On Request
	2	-	21"	15-3/4"	5"	1	
	1	-	21"	15-3/4"	7-21/32"		
HD28M4	4	-	21"	15-3/4"	2-5/32"		On Request
	-	1	22-13/32"	17-5/8"	16-7/32"	1	

### TOP CHEST WITH DRAWERS - HD SERIES



**55 LB DRAWER LOAD CAPACITY**

**28"**

**4 DRAWERS**



### PERFORATED PANEL FOR CABINETS - HD SERIES



**28"**

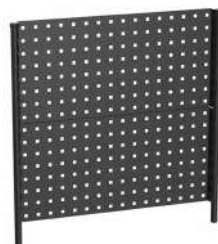

### CAN HOLDER FOR CABINETS - HD SERIES



ITEM	WIDTH	DEPTH	HEIGHT	🔒	AVAILABLE
HD28S4	28"	18"	14"	1	On Request

ITEM	DESCRIPTION	CAPACITY	🔒	AVAILABLE
HDAC1	Perforated panel	44 lb	1	On Request

ITEM	CAPACITY	🔒	AVAILABLE
HDAC2	11 lb	1	On Request

## ROLLER CABINETS

### DOCUMENT HOLDER FOR CABINETS – HD SERIES



**BAG**

ITEM	CAPACITY	⊞	AVAILABLE
HDAC3	11 lb	1	On Request

### SHELF WITH PAPER TOWEL HOLDER – HD SERIES



**BAG**

ITEM	CAPACITY	⊞	AVAILABLE
HDAC4	11 lb	1	On Request

### TRASH COLLECTION BIN FOR CABINETS – HD SERIES



**BAG**

ITEM	CAPACITY	⊞	AVAILABLE
HDAC5	11 lb	1	On Request

### SECURITY BAR FOR CABINETS – HD SERIES



- Cabinet locking system that provides greater user safety.
- 1/32" cold bent steel sheet.
- Standard central lock.

ITEM	GAUGE	⊞	AVAILABLE
HDAC6	19	1	On Request

### CASTER SET FOR CABINETS – HD SERIES



**4**  
PIECES



**BAG**

ITEM	DIAMETER	⊞	AVAILABLE
HDFEF1	5"	1	On Request

- For HD series cabinets.
- Manufactured of polyurethane.
- Includes nut and screws for installation.

### CABINET LOCK AND KEY SET – HD SERIES



**BAG**

- Includes three keys.

ITEM	DESCRIPTION	⊞	AVAILABLE
HDFEF2	HD Cabinet Lock	1	On Request



Full extension gas shock absorbers to facilitate opening and closing (H41S8).



Locking lid hinges on top chests (H27S6).



Large push handle for easy mobility (H27M4 and H27M6).



Full length aluminium drawer pulls.



Ball bearing drawers slides.



Heavy-Duty lift handles on top chest (H41S8).



Tubular high security lock and key.



Heavy-duty rubberized push handle item (H41M12).



Deep inset handles items (H27S6 and H27I2).



Heavy duty 5"x 2" casters with 331 lb weight capacity per caster.

Sheet steel gauge (models H41M12 y H41S8):  
-Frame: 19 gauge.  
-Drawers: 20 gauge.

Sheet steel gauge in other models:  
-Frame: 20 gauge.  
-Drawers: 22 gauge.

### ROLLER CABINET WITH DRAWERS – H SERIES



**55 LB**  
DRAWER LOAD CAPACITY

**41"**

**12**  
DRAWERS

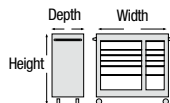

ITEM	DRAWERS	WIDTH	DEPTH	HEIGHT	⊞	AVAILABLE
H41M12	2	23-3/8"	15-7/8"	4-15/16"	1	✓
	3	23-3/8"	15-7/8"	3-1/8"		
	1	23-3/8"	15-7/8"	8-5/8"		
	2	10-3/8"	15-7/8"	4-15/16"		
	3	10-3/8"	15-7/8"	3-1/8"		
	1	10-3/8"	15-7/8"	8-5/8"		

**ROLLER CABINETS**

**ROLLER CABINETS WITH DRAWERS – H SERIES**



**55 LB**  
DRAWER LOAD CAPACITY

**27"**

**6**  
DRAWERS



**H27M6**

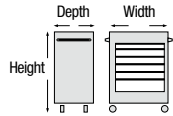

ITEM	DRAWERS	WIDTH	DEPTH	HEIGHT	☑	AVAILABLE
<b>H27M6</b>	1	23"	16"	2-1/2"		
	4	23"	16"	3-1/2"	1	✓
	1	23"	16"	5-1/16"		



**55 LB**  
DRAWER LOAD CAPACITY

**27"**

**4**  
DRAWERS



**H27M4**

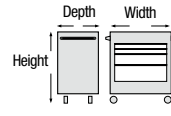

ITEM	DRAWERS	WIDTH	DEPTH	HEIGHT	☑	AVAILABLE
<b>H27M4</b>	2	23"	15"	2-1/4"		
	1	23"	15"	4-1/2"	1	✓
	1	23"	15"	7-1/4"		



- Multifunctional top design
- Full extension gas shock absorbers to facilitate opening and closing.
- Full length aluminium drawer pulls
- Ball-bearing drawer slides
- Four 5" x 2" casters with 331 lb weight capacity per caster.
- Includes: 12 hooks and 10 plastic bins

Sheet steel gauge:  
-Frame: 20 gauge.  
-Drawer: 22 gauge.

**MOBILE WORK CENTER WITH DRAWERS – H SERIES**



**66 LB**  
DRAWER LOAD CAPACITY

**35"**

**7**  
DRAWERS

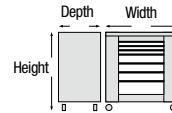

ITEM	DRAWERS	WIDTH	DEPTH	HEIGHT	☑	AVAILABLE
<b>H35W7</b>	3	22-3/8"	16"	2-3/16"		
	3	22-3/8"	16"	4-3/8"	1	On Request
	1	22-3/8"	16"	6-11/16"		



- Ball-bearing drawer glides.
- Four 4" x 1" casters with 110 lb weight capacity on per caster
- Push handles both sides



**66 LB**  
DRAWER LOAD CAPACITY

**27"**

**3**  
DRAWERS



ITEM	DRAWERS	WIDTH	DEPTH	HEIGHT	☑	AVAILABLE
<b>H27W3</b>	2	22-13/16"	16-5/8"	4"		
	1	22-13/16"	16-5/8"	6"	1	On Request

## ROLLER CABINETS

ORGANIZATION AND STORAGE

### TOP CHESTS WITH DRAWERS – H SERIES



**55 LB**  
DRAWER LOAD CAPACITY

**41"**

**8**  
DRAWERS

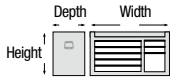

ITEM	DRAWERS	WIDTH	DEPTH	HEIGHT	☑	AVAILABLE
H41S8	5	23-3/8"	14-3/8"	3-1/8"		
	2	10-3/8"	14-3/8"	3-1/8"	1	✓
	1	10-3/8"	14-3/8"	9-5/8"		



**33 LB**  
DRAWER LOAD CAPACITY

**27"**

**6**  
DRAWERS

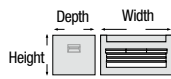

ITEM	DRAWERS	WIDTH	DEPTH	HEIGHT	☑	AVAILABLE
H27S6	3	7-3/4"	10-1/4"	1-1/2"		
	2	22-1/2"	10-1/4"	1-1/2"	1	✓
	1	22-5/8"	10-1/4"	2-3/8"		



VIDEO



### INTERMEDIATE CHEST WITH DRAWERS – H SERIES



**33 LB**  
DRAWER LOAD CAPACITY

**27"**

**2**  
DRAWERS

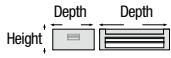

ITEM	DRAWERS	WIDTH	DEPTH	HEIGHT	☑	AVAILABLE
H27I2	1	22-5/8"	10-3/8"	1-5/8"	1	✓
	1	22-5/8"	10-3/8"	2-3/8"		

### CASTERS SET FOR CABINETS – H SERIES



**243 LB**  
LOAD CAPACITY PER CASTER

**4**  
PIECES



- Includes nuts and screws for installation.
- 2 mobile casters with brakes.

ITEM	FOR MODELS	☑	AVAILABLE
RGREF2	H27M6 H27M4	1	On Request

### TOP CHEST WITH COMPARTMENT – 99 SERIES



**55 LB**  
DRAWER LOAD CAPACITY

**22"**

**1**  
DRAWERS

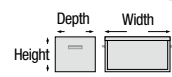

ITEM	WIDTH	DEPTH	HEIGHT	☑	AVAILABLE
9992	22"	13-9/16"	11-13/16"	1	On Request

### ROLLER CABINETS WITH DRAWERS



**134 LB**  
DRAWER LOAD CAPACITY

**26"**

**9**  
DRAWERS

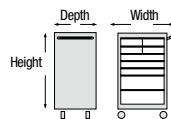

ITEM	DRAWERS	WIDTH	DEPTH	HEIGHT	☑	AVAILABLE
9997	2	10-5/8"	16-15/32"	4-5/32"		
	2	10-5/8"	16-15/32"	3-5/64"		
	3	22-3/8"	16-15/32"	3-5/64"	1	On Request
	2	22-3/8"	16-15/32"	6-21/64"		



**125 LB**  
DRAWER LOAD CAPACITY

**26"**

**7**  
DRAWERS

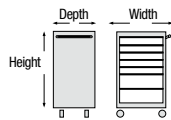

ITEM	DRAWERS	WIDTH	DEPTH	HEIGHT	☑	AVAILABLE
9996	1	22-3/8"	16-15/32"	4-5/32"		
	4	22-3/8"	16-15/32"	3-5/64"	1	On Request
	2	22-3/8"	16-15/32"	6-21/64"		



## ROLLER CABINETS



Full-length aluminium drawer pulls.

### I27M5



Ball-bearing drawer slides.



Heavy-duty side handle.



5 x 2" casters with 175 lb weight capacity per caster.

### I27M3



Friction Drawer Rails.



Large push handle for easy mobility.



5 x 2" casters with 175 lb weight capacity per caster.

Sheet steel gauge in roller cabinet:  
-Frame: 19 gauge.  
-Drawers: 20 gauge.

Sheet steel in top chest:  
-Frame: 20 gauge.  
-Drawers: 22 gauge.

## ROLLER CABINETS WITH DRAWERS – I SERIES



**55 LB** DRAWER LOAD CAPACITY

**77 LB** DRAWER LOAD CAPACITY



**27"**

**5** DRAWERS



**33 LB** DRAWER LOAD CAPACITY

**27"**

**3** DRAWERS

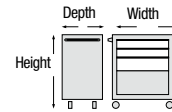
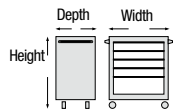

ITEM	DRAWERS	WIDTH	DEPTH	HEIGHT	CAPACIDAD KG	AVAILABLE
I27M5	3	22-7/16"	16"	3"	55 lb	1 On Request
	2	22-7/16"	16"	6"	77 lb	

ITEM	DRAWERS	WIDTH	DEPTH	HEIGHT	AVAILABLE
I27M3	2	23-3/16"	16-3/16"	4"	1 On Request
	1	23-3/16"	16-3/16"	6"	

## TOP CHESTS WITH DRAWERS – I SERIES



**22 LB** DRAWER LOAD CAPACITY

**27"**

**6** DRAWERS



**22 LB** DRAWER LOAD CAPACITY

**27"**

**4** DRAWERS

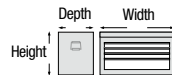
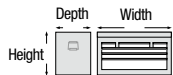

ITEM	DRAWERS	WIDTH	DEPTH	HEIGHT	AVAILABLE
I27S6	2	5"	11"	1-7/8"	1 On Request
	1	11"	11"	1-7/8"	
	2	23-3/16"	11"	1-7/8"	
	1	23-3/16"	11"	4"	

ITEM	DRAWERS	WIDTH	DEPTH	HEIGHT	AVAILABLE
I27S4	3	23-3/16"	11"	1-7/8"	1 On Request
	1	23-3/16"	11"	4"	



## INTEGRATED CABINET WITH DRAWERS – I SERIES



**13 LB** TOP CHEST DRAWERS LOAD CAPACITY

**17 LB** ROLLER CABINET DRAWERS LOAD CAPACITY

**24"**

**10** DRAWERS



Lid hinges lock.



3" x 1" casters.



Security bar for better drawers block.

Sheet steel gauge:  
-Frame: 23 gauge.  
-Drawers: 25 gauge.

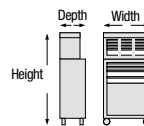

ITEM	DRAWERS	WIDTH	DEPTH	HEIGHT	AVAILABLE
I24C10	Top chest				1 On Request
	3	6"	8-7/8"	1-9/16"	
	2	20"	8-7/8"	1-9/16"	
	1	20"	8-7/8"	3-5/16"	
	Roller cabinet				
	2	20"	8-7/8"	1-9/16"	
2	20"	8-7/8"	1-9/16"		

## ROLLER CABINETS

ORGANIZATION AND STORAGE



Lid hinges lock.



3" x 1" casters.



Security bar for better drawers block.

Sheet steel gauge:  
-Frame: 23 gauge.  
-Drawers: 25 gauge.

### INTEGRATED CABINET WITH DRAWERS – I SERIES



**22 LB**  
DRAWER LOAD CAPACITY

**22"**

**4**  
DRAWERS

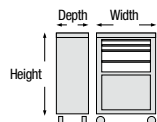

ITEM	DRAWERS	WIDTH	DEPTH	HEIGHT	AVAILABILITY
I24C4	3	6"	8-7/8"	1-9/16"	1 On Request
	2	18-7/64"	10-5/8"	1-31/32"	
	2	18-7/64"	10-5/8"	3-15/16"	
	Roller cabinet				
	1	18-7/64"	10-5/8"	12-63/64"	



Sheet Thickness:  
Structure: Gauge 20  
Drawers: Gauge 20



Drawers with ball bearing slides.



Heavy-duty 5" x 2" wheels supporting up to 162.5 kg.



Heavy-duty side handle.



EVA foam liners in all drawers.



Galvanized locking system.

### ROLLER CABINETS WITH DRAWERS – IN SERIES



**55 LB**  
TOP DRAWER  
LOAD CAPACITY

**77 LB**  
DRAWER LOAD CAPACITY

**27"**

**6**  
DRAWERS



IN27M6



**55 LB**  
TOP DRAWER  
LOAD CAPACITY

**77 LB**  
DRAWER LOAD CAPACITY

**27"**

**5**  
DRAWERS



IN27M5



**55 LB**  
TOP DRAWER  
LOAD CAPACITY

**77 LB**  
DRAWER LOAD CAPACITY

**27"**

**3**  
DRAWERS



IN27M3

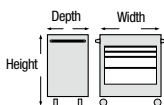

VIDEO

NEW



ITEM	DRAWERS	COMPARTMENT	WIDTH	DEPTH	HEIGHT	AVAILABILITY
IN27M6	6	-	23-1/32"	16-11/32"	3-5/8"	1 ✓
IN27M5	4	-	21"	27"	4"	1 ✓
IN27M3	3	-	21"	27"	10"	1 ✓
IN27M3	-	1	23-1/32"	16-11/32"	3-5/8"	1 ✓
IN27M3	-	-	23-1/32"	16-11/32"	11-52/64"	1 ✓

**ROLLER CABINETS**

**INDUSTRIAL DUTY**

With sliding rails that allows the cases to pull out like drawers for easy access to their contents.

Removable briefcase-style boxes. Easy to carry to the job site and store after use

Heavy-duty metal handle

Heavy-duty metal handle

Opening button.

Case rails with ball bearings

**INSERT BOXES**  
Keeps small components organized and accessible.

**x 8**  
2-1/8 x 2-1/8 x 2-31/64 in

**x 8**  
4-1/4 x 2-1/8 x 2-31/64 in

**x 4**  
4-1/4 x 4-1/4 x 2-31/64 in

**x 1**  
8-1/2 x 4-1/4 x 2-31/64 in

Sheet Thickness:  
Frame: 23-gauge  
Cases: 23-gauge

**UPPER CABINET WITH BRIEFCASE-STYLE CASES**

**INDUSTRIAL DUTY**

**11 LB**  
BRIEFCASE LOAD CAPACITY

**20"**

**3**  
BOXES

**URREA**

**NEW**

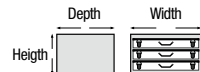
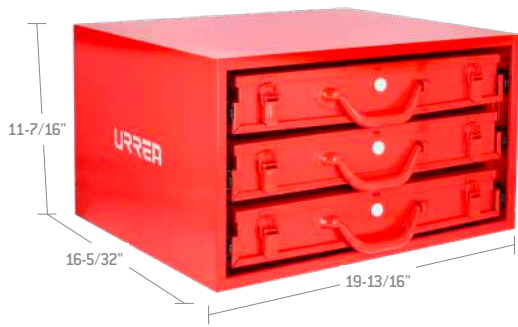

ITEM	BOXES	WIDTH	DEPTH	HEIGHT	☞	AVAILABLE
<b>GS3C</b>	<b>3</b>	13-3/16"	9"	2-25/32"	1	<b>On Request</b>

**PROFESSIONAL USE**

Sheet steel gauge: -Frame: 20 gauge. -Drawers: 20 gauge.

Soft close drawer slides.

Aluminum handles.

Side handle mod. 125113.

Tubular side handle mod. 125114.

High security drawer closing mechanism.

2 fixed 4" x 1" caster.

2 mobile casters with 4" x 1" brake.

**BLACK ROLLER CABINET**

**PROFESSIONAL USE**

**33 LB**  
DRAWER LOAD CAPACITY

**27"**

**5**  
DRAWERS

125113

30-11/16"

17-5/16"

26-3/4"

**PROFESSIONAL USE**

**33 LB**  
DRAWER LOAD CAPACITY

**27"**

**4**  
DRAWERS

125114

30-11/16"

17-6/16"

26-3/4"

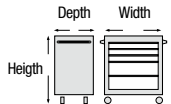

ITEM	DRAWERS	COMPARTMENT	WIDTH	DEPTH	HEIGHT	☞	AVAILABLE
<b>125113</b>	<b>3</b>	-	21 5/8"	15-3/16"	3"	1	<b>On Request</b>
	<b>2</b>	-	21 5/8"	15-3/16"	6-1/8"	1	<b>On Request</b>
	<b>2</b>	-	22-7/16"	16-1/6"	1-7/8"	1	<b>On Request</b>
<b>125114</b>	<b>2</b>	-	22-7/16"	16-1/6"	3"	1	<b>On Request</b>
	-	<b>1</b>	22-7/16"	10-3/4"	11-1/32"	1	<b>On Request</b>

**BLACK TOP CHEST 27"**

**PROFESSIONAL USE**

**33 LB**  
DRAWER LOAD CAPACITY

**26"**

**6**  
DRAWERS

125115

14-13/16"

12-1/16"

26"

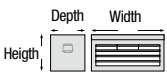

ITEM	DRAWERS	WIDTH	DEPTH	HEIGHT	☞	AVAILABLE
<b>125115</b>	<b>3</b>	4-2/9"	10-3/4"	2"	1	<b>On Request</b>
	<b>2</b>	22-4/9"	10-3/4"	2"	1	<b>On Request</b>
	<b>1</b>	4-2/9"	10-3/4"	3"	1	<b>On Request</b>

## ROLLER CABINETS



Sheet steel gauge:  
-Frame: 23 gauge.  
-Drawers: 23 gauge.



Drawers with handles.



Side handles



Thermo-hardened electrostatic painting.



Security bar to lock drawers.



Padlock for security.



4 3/8" x 1-1/4" swivel casters.

### YELLOW AND GRAY ROLLER CABINETS



**22 LB** DRAWER LOAD CAPACITY

**25"**  
**6** DRAWERS

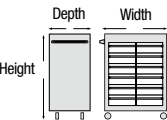

ITEM	DRAWERS	COMPARTMENT	WIDTH	DEPTH	HEIGHT	☑	AVAILABLE
125106	4	-	19-5/8"	14-5/32"	3"	1	✓
GM6G	4	-	19-5/8"	14-5/32"	3"	1	✓
	2	-	19-5/8"	14-5/32"	4-2/3"		



**22 LB** DRAWER LOAD CAPACITY

**26"**  
**3** DRAWERS

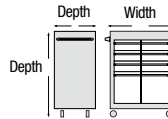

ITEM	DRAWERS	COMPARTMENT	WIDTH	DEPTH	HEIGHT	☑	AVAILABLE
125100	2	-	19-5/8"	14-5/32"	3"	1	✓
	-	1	20-2/3"	14-5/32"	12-7/16"		
GM3G	2	-	19-5/8"	14-5/32"	3"	1	✓
	1	-	19-5/8"	14-5/32"	4-11/16"		
	-	1	20-2/3"	14-5/32"	12-7/16"		

**SURTEK**  
TOOLS FOR SPECIALISTS



**NEW**

### YELLOW AND GRAY TOP CHESTS



**22 LB** DRAWER LOAD CAPACITY

**21"**  
**3** DRAWERS



ITEM	DRAWERS	WIDTH	DEPTH	HEIGHT	☑	AVAILABLE
125109	3	18-3/32"	11-13/16"	3-23/64"	1	✓
GS3G	3	18-3/32"	11-13/16"	3-23/64"	1	On Request

**SURTEK**  
TOOLS FOR SPECIALISTS



### MULTIPURPOSE CASE

#### MULTIPURPOSE TOOL CASE



**URREA**  
SUPERIOR QUALITY AFFORDABLE TOOLS



EMUG

EMUC

- Adhesive tapes to automotive upholstery.
- Wide and resistant handles.
- Pocket for small parts and manuals.

ITEM	LENGTH	HEIGHT	WIDTH	☑	AVAILABLE
EMUG	18-57/64"	3-15/16"	3-15/16"	1	On Request
EMUC	3-15/16"	8-17/64"	1-37/64"	1	On Request

#### MULTIPURPOSE TOOLCASE



**SURTEK**  
TOOLS FOR SPECIALISTS



EMSG

EMSC

- Adhesive tapes to automotive upholstery.
- Wide and resistant handles.
- Pocket for small parts and manuals.

ITEM	LENGTH	HEIGHT	WIDTH	☑	AVAILABLE
EMSG	18-57/64"	9-1/16"	3-15/16"	1	On Request
EMSC	9-27/32"	8-17/64"	1-31/32"	1	On Request

**TOOL BAGS**

**POLYESTER TOOL BAGS**



**22"**  
**13**  
POCKETS

- 5 outside pockets
- 8 inside pockets
- Mounted on rollers for portability
- Extending pull handle, padded carry handles and adjustable shoulder strap.



MP122

**19"**  
**21**  
POCKETS

- 13 outside pockets
- 8 inside pockets
- Rugged molded plastic base for durability.
- Adjustable shoulder strap and handles for easy carrying.



MP117

**18"**  
**12**  
POCKETS

- 8 outside pocket
- 4 inside pockets
- Rugged molded plastic base for durability.
- Handle of high tensile steel with rubber grip and adjustable shoulder strap.



MP218

**15"**  
**20**  
POCKETS

- 12 outside pockets
- 8 inside pockets
- Manufactured with 600D polyester fabric.
- Adjustable shoulder strap and handles for easy carrying.



MP215

- Manufactured with 1680D polyester fabric for more resistance.
- Large inside compartment allows an easy visibility and direct access to the tools and parts.

ITEM	POCKETS	WIDTH	DEPTH	HEIGHT	STORAGE CAPACITY	AVAILABILITY
MP122	13	22"	11"	10-1/2"	41.6 L / 11 gal	On Request
MP117	21	19"	9"	10-1/2"	29.4 L / 7.8 gal	On Request

ITEM	POCKETS	WIDTH	DEPTH	HEIGHT	STORAGE CAPACITY	AVAILABILITY
MP218	12	18"	8"	13"	30.7 L / 8.1 gal	On Request
MP215	20	15"	9"	12"	26.5 L / 7 gal	On Request

**BULK**

**POLYESTER TOOL BACKPACK WITH REMOVABLE TOOL HOLDER**



**MADE OF POLYESTER**

**STEEL WIRE HANDLE**

**REINFORCED PLASTIC BASE**

**REFLECTIVE HI-VIS BANDS**

**20"**  
**23**  
POCKETS



- Removable tool holder with 48 pockets.

- 21 main pockets.
- 2 side pockets.
- Padded back with foam for carrying comfort.
- Adjustable padded shoulder straps with reflective tape.



MPE

**20"**  
**23**  
POCKETS



- Removable tool holder with 48 pockets.

- 21 main pockets.
- 2 side pockets.
- Padded back with foam for carrying comfort.
- Adjustable padded shoulder straps with reflective tape.

**PADED LAPTOP COMPARTMENT**



MPEP

ITEM	WIDTH	DEPTH	HEIGHT	STORAGE CAPACITY	AVAILABILITY
MPE	10"	13"	17"	77 lb	On Request

ITEM	WIDTH	DEPTH	HEIGHT	STORAGE CAPACITY	AVAILABILITY
MPEP	10"	13"	17"	77 lb	On Request

**POLYESTER TOOL BACKPACK**



**20"**  
**8**  
POCKETS

- Made of heavy-duty polyester with interior lined.
- 1 large padded exterior pocket with neoprene lining.
- 2 side pockets.
- 4 front pockets.
- 1 removable inner pocket.
- Heavy-duty top and front handles.
- Padded back panel for comfortable carrying.
- Adjustable padded shoulder straps.
- Dual metal zippers.
- Reinforced waterproof EVA base with feet to protect against floor moisture.



MPH

ITEM	WIDTH	DEPTH	HEIGHT	STORAGE CAPACITY	AVAILABILITY
MPH	15"	8"	20"	35.4 L / 9.4 gal	✓

**POLYESTER TOOL HOLDER**



**18"**  
**1**  
POCKET

- Made of heavy-duty polyester with interior lined.
- Large main compartment with ample space.
- 1 large exterior pocket.
- Heavy-duty top handles.
- Adjustable shoulder strap.
- Dual metal zippers.
- Reinforced waterproof EVA base with feet to protect against floor moisture.
- Makes it easy to transport and store tools while keeping your hands free.



POPH

ITEM	WIDTH	DEPTH	HEIGHT	STORAGE CAPACITY	AVAILABILITY
POPH	15"	8"	20"	23 L / 6.1 gal	✓

## OIL-TANNED LEATHER

### OIL-TANNED LEATHER TOOL BAG WITH BELT AND POCKETS

**HEAVY DUTY** **GENUINE LEATHER** **REINFORCED RIVETS AND DOUBLE SEAM** **INCLUDES BELT**

URREA



**16**  
POCKETS



BN134

- Made from oil-tanned leather designed to work on extreme weather.

- Heavy-duty belt with buckle.
- Middle pocket.
- Includes belt.

**10**  
POCKETS



BN138

- Not includes metal hooks or accessories that can scratch metal surfaces.
- Non-metallic hammer holder.

**9**  
POCKETS



BN136

- Includes hammer holder.

**4**  
POCKETS



BN137

- Includes non-metallic hammer holder.



ITEM	BN134	BN138	BN136	BN137
POCKETS	16 pockets	10 pockets	9 pockets	4 pockets
DIMENSIONS	12" x 23-13/16"	9-1/2" x 12-1/2"	9-3/8" x 11-7/16"	9-3/8" x 11-7/16"
AVAILABLE	✓	On Request	On Request	✓

### SPLIT LEATHER TOOL BELT WITH POCKETS

**PROFESSIONAL USE** **GENUINE LEATHER**

SURTEK



NEW

**10**  
POCKETS



124400

- Metal clip for hanging a measuring tape.
- Leather hammer holder.
- Made of 100% genuine cowhide leather.
- Reinforced rivets.

**6**  
POCKETS



124401

- Leather hammer holder.
- Made of 100% genuine cowhide leather.
- Reinforced rivets.

**3**  
POCKETS



124403

- Leather hammer holder.
- Adjustable nylon belt with plastic buckle.
- Made of 100% genuine cowhide leather.
- Reinforced rivets.



ITEM	124400	124401	124403
POCKETS	10	6	3
DIMENSIONS	11-13/16" x 23-3/8"	11" x 12"	12" x 10"
AVAILABLE	✓	✓	✓

### OIL-TANNED LEATHER TOOL BAG WITH POCKETS

**HEAVY DUTY** **GENUINE LEATHER** **REINFORCED RIVETS AND DOUBLE SEAM** **INCLUDES BELT**

URREA



**10**  
POCKETS



BN133

- Measure tape holder.
- Hook for insulating tape.
- Great resistance to cracks and punctures.
- Safe hook.

**6**  
POCKETS



BN142

- Hammer holder.

**5**  
POCKETS



BN132

- Includes hook for insulating tape and multi-purpose hook.

**2**  
POCKETS



BN129

- Genuine bovine cowhide leather.



ITEM	BN133	BN142	BN132	BN129
POCKETS	10 pockets	6 pockets	5 pockets	2 pockets
DIMENSIONS	10" x 10"	9-1/4" x 9"	9-1/4" x 9"	4-1/2" x 13-1/2"
AVAILABLE	✓	On Request	✓	✓

**OIL-TANNED LEATHER**

**SUEDE AND SADDLE LEATHER TOOL POUCH WITH POCKETS**

PROFESSIONAL USE GENUINE LEATHER

**4 POCKETS**



- 100% bovine leather.
- Metallic tape holder.
- Reinforced with stitching and rivets.

PLASTIC BAG

ITEM	PHC4S
POCKETS	4
DIMENSIONS	11" x 9-7/8"
☒	1
AVAILABLE	✓

**POLYESTER TOOL BELTS**

**POLYESTER TOOL BELT WITH POCKETS**

INDUSTRIAL DUTY

**9 POCKETS**



BN139

- Hammer holder.

ITEM	BN139
POCKETS	9 Pockets
DIMENSIONS	13" x 15-1/4"
☒	1
AVAILABLE	✓

**4 POCKETS**



BN140

- Measuring tape holder.
- Multipurpose hook.

ITEM	BN140
POCKETS	4 Pockets
DIMENSIONS	13" x 15-1/4"
☒	1
AVAILABLE	On Request

**SCRATCH-RESISTANT POLYESTER TOOL BELT WITH POCKETS**

INDUSTRIAL DUTY INCLUDES BELT

**4 POCKETS**



- Ideal for use in workshops and automotive assemblers without risk of causing damages.

- Manufactured in polyester heavy duty 600 denier for higher strength.
- Includes polypropylene belt of 48-7/16".
- It has reinforced seams.
- Not metallic components.

BULK

ITEM	BN143
POCKETS	4 Pockets
DIMENSIONS	10-5/8" x 8-5/8"
☒	1
AVAILABLE	On Request

**POLYESTER TOOL BELT WITH POCKETS**

PROFESSIONAL USE

**13 POCKETS**



- Made of durable polyester.
- Ideal for organizing various tools.
- Large tool pouch with hammer hanging hook.

ITEM	124189
POCKETS	13
DIMENSIONS	10-5/8" x 8-5/8"
☒	1
AVAILABLE	✓

**POLYESTER TOOL HOLDER BELT WITH POCKETS**

PROFESSIONAL USE

**7 POCKETS**



- Made of durable polyester.
- Wide, easy-to-adjust belt.
- Metal clip for hanging a measuring tape.

ITEM	124190
POCKETS	13
DIMENSIONS	8-1/2" x 10-1/4"
☒	1
AVAILABLE	✓

**SOCKET RAILS AND CLIPS**

**SOCKET RAILS**

INDUSTRIAL DUTY



2585

- They allow to keep the dice organized.
- Designed to hold the sockets and remove them easily.

BULK

ITEM	LENGTH	☒	AVAILABLE
2584	6"	20	✓
2585	4"	20	✓

**SOCKET CLIPS**

INDUSTRIAL DUTY



2593

- They allow to keep the dice organized.
- Designed to hold the sockets and remove them easily.

ITEM	SQUARE DRIVE	☒	AVAILABLE
2590B	1/4"	20	✓
2591B	3/8"	20	On Request
2592B	1/2"	20	✓
2593B	3/4"	20	✓

ITEM	SQUARE DRIVE	☒	AVAILABLE
2590	1/4"	20	✓
2592	1/2"	20	✓

**SURTEK**  
TOOLS FOR SPECIALISTS



usa.urrea.com





CLASS	TYPE	PAGE	BRAND	
			URREA	SURTEK
Drive socket sets and accessories	Sockets and accessories sets	96	•	•
	1/4" Hand sockets and accessories set	96	•	•
	3/8" Hand sockets and accessories set	96	•	•
	1/2" Hand sockets and accessories set	96	•	•
	3/4" Hand sockets and accessories set	110	•	•
	1" Hand sockets and accessories set	111	•	•
Hand sockets	1/4" Hand sockets	112	•	•
	3/8" Hand sockets	118	•	•
	1/2" Hand sockets	128	•	•
	3/4" Hand sockets	138	•	•
	1" Hand sockets	142	•	•
Hand accessories	Adapters	143	•	•
	Drive sliding T-handle	143	•	•
	Drive extensions	144	•	•
	Drive socket driver	144	•	•
	Drive speed handle	144	•	•
	Drive locking extensions	145	•	•
	L-handle	146	•	•
	Ratchets	147	•	•
	Drive universal joint	154	•	•

[usa.urrea.com](http://usa.urrea.com)

We are constantly improving our products, that is why the information, characteristics and availability of them can change without prior notice.

## DRIVE GO-THROUGH SOCKET SETS WITH ACCESSORIES

HAND SOCKETS AND ACCESSORIES

# GO-THROUGH.



**GREAT VERSATILITY:** same socket fulfills the function of a deep or low-profile socket. Can be used indistinctly in 6 different geometries.



For working with long threaded bolts and screws, where standard socket cannot be used.

### 3/8" AND 1/2" DRIVE GO-THROUGH SOCKET SET WITH ACCESSORIES

**INDUSTRIAL DUTY** **INCHES** **SPLINE** **3/8"** **1/2"**

**39 PIECES**



ITEM	PIECES	DRIVE					AVAILABLE
4752GT	39	3/8" & 1/2"	21	10	8	Plastic box	1 ✓

### 3/8" DRIVE GO-THROUGH SOCKET SET WITH ACCESSORIES

**INDUSTRIAL DUTY** **INCHES** **SPLINE** **3/8"**

**14 PIECES**



ITEM	PIECES	DRIVE					AVAILABLE
5201GT	14	3/8"	11	3		Plastic rack	1 ✓

## COMBINATION DRIVE SOCKET SETS

### 1/4", 3/8" AND 1/2" DRIVE SOCKET SET WITH ACCESSORIES

**HEAVY DUTY** **INCHES** **METRIC** **1/4"** **3/8"** **1/2"** **12** **6** **6**

**99 PIECES**



ITEM	PIECES	DRIVE					AVAILABLE
5447PA	99	1/4" 3/8" & 1/2"	89	10		Plastic case	1 ✓

### 1/4", 3/8" AND 1/2" DRIVE SOCKET SET WITH ACCESSORIES

**HEAVY DUTY** **INCHES** **METRIC** **1/4"** **3/8"** **1/2"** **12** **6** **6**

**76 PIECES**



ITEM	PIECES	DRIVE					AVAILABLE
475254	76	1/4", 3/8" & 1/2"	61	9	5	Metal box 5495	1 ✓

### 1/4", 3/8" AND 1/2" DRIVE GO-THROUGH SOCKET SET WITH ACCESSORIES

**INDUSTRIAL DUTY** **INCHES** **METRIC** **SPLINE** **1/4"** **3/8"** **1/2"**

**49 PIECES**



ITEM	PIECES	DRIVE					AVAILABLE
JGT01	49	1/4", 3/8" & 1/2"	26	10	13	Plastic box	1 ✓

### 1/2" DRIVE GO-THROUGH SOCKET SET WITH ACCESSORIES

**INDUSTRIAL DUTY** **INCHES** **METRIC** **SPLINE** **1/2"**

**15 PIECES**



ITEM	PIECES	DRIVE					AVAILABLE
5401GT	15	1/2"	12	3		Plastic rack	1 ✓

### 1/4" DRIVE GO-THROUGH SOCKET SET WITH ACCESSORIES

**INDUSTRIAL DUTY** **INCHES** **METRIC** **SPLINE** **1/4"**

**14 PIECES**



**VIDEO**

ITEM	PIECES	DRIVE					AVAILABLE
4701GT	14	1/4"	11	3		Plastic rack	1 ✓

## COMBINATION DRIVE SOCKET SETS

### 1/4" AND 3/8" DRIVE SOCKET SET WITH ACCESSORIES



INCHES  
METRIC



63  
PIECES



ITEM	PIECES	DRIVE				AVAILABLE
JCD01	63	1/4" & 3/8"	48	5	10	Plastic case 1 <span>On Request</span>

### 1/4" AND 3/8" DRIVE SOCKET SET WITH ACCESSORIES



INCHES  
METRIC



41  
PIECES



ITEM	PIECES	DRIVE				AVAILABLE
4700D	41	1/4" & 3/8"	36	4	1	Metal box 5396 1 <input checked="" type="checkbox"/>

### 1/4" AND 1/2" DRIVE SAE SOCKET SET WITH ACCESSORIES



INCHES



51  
PIECES



ITEM	PIECES	DRIVE				AVAILABLE
4754P50	51	1/4" & 1/2"	24	16	10	Plastic box CPUC20 1 <input checked="" type="checkbox"/>

### 1/4" AND 1/2" DRIVE SAE SOCKET SET WITH ACCESSORIES



INCHES



50  
PIECES



ITEM	PIECES	DRIVE				AVAILABLE
4754P	50	1/4" & 1/2"	24	16	10	Plastic case 1 <span>On Request</span>

### 3/8" AND 1/2" DRIVE SAE SOCKET SET WITH ACCESSORIES



INCHES



37  
PIECES



ITEM	PIECES	DRIVE				AVAILABLE
5254P36	37	3/8" & 1/2"	26	10	1	Plastic box CPUC20 1 <input checked="" type="checkbox"/>

### 3/8" AND 1/2" DRIVE SAE SOCKET SET WITH ACCESSORIES



INCHES



37  
PIECES



ITEM	PIECES	DRIVE				AVAILABLE
5452	37	3/8" & 1/2"	26	10	1	Metal box 5495 1 <input checked="" type="checkbox"/>

### 3/8" AND 1/2" DRIVE SAE SOCKET SET WITH ACCESSORIES



INCHES



35  
PIECES



ITEM	PIECES	DRIVE				AVAILABLE
5254P34	35	3/8" & 1/2"	26	8	1	Plastic box CPUC20 1 <span>On Request</span>

### 3/8" AND 1/2" DRIVE SAE SOCKET SET WITH ACCESSORIES



INCHES



35  
PIECES



ITEM	PIECES	DRIVE				AVAILABLE
5452PT	35	3/8" & 1/2"	26	9	1	Canvas case 1 <input checked="" type="checkbox"/>

# 03 HAND SOCKETS AND ACCESSORIES

## COMBINATION DRIVE SOCKET SET

### 1/4" AND 3/8" DRIVE SAE SOCKET SET WITH ACCESSORIES



**27**  
PIECES



ITEM	PIECES	DRIVE	🗄️	🔩	🔪	🛠️	📦	📄	📌	📅	📍
5200A	27	1/4" & 3/8"	18	8	Metal box 5396	1	✓				

### 1/4" AND 1/2" DRIVE METRIC SOCKET SET WITH ACCESSORIES



**50**  
PIECES



ITEM	PIECES	DRIVE	🗄️	🔩	🔪	🛠️	📦	📄	📌	📅	📍
4754PM	50	1/4" & 1/2"	24	16	10	Plastic case	1	✓			

### 1/4" AND 3/8" DRIVE TORX BIT SOCKET SET



**9**  
PIECES



•Forged in one piece

ITEM	PIECES	DRIVE 1/4"	DRIVE 3/8"	🗄️	📄	📌	📅	📍
4752W	9	T10 to T30	T40 to T50	Plastic organizer	1	✓		

### 1/4", 3/8" AND 1/2" DRIVE TORX BIT SOCKET SET



**12**  
PIECES



ITEM	PIECES	DRIVE 1/4"	DRIVE 3/8"	DRIVE 1/2"	🗄️	📄	📌	📅	📍
475254T	12	T10 to T30	T40 to T60	T60	Plastic organizer	1	On Request		

### 1/4" AND 1/2" DRIVE METRIC SOCKET SET WITH ACCESSORIES



**51**  
PIECES



ITEM	PIECES	DRIVE	🗄️	🔩	🔪	🛠️	📦	📄	📌	📅	📍
4754P50M	51	1/4" & 1/2"	24	16	10	Plastic box CPUC20	1	On Request			

## COMBINATION DRIVE TORX BIT SOCKET SETS

### 1/4", 3/8" AND 1/2" DRIVE TORX BIT SOCKET SET



**12**  
PIECES



•Forged in one piece

ITEM	PIECES	DRIVE 1/4"	DRIVE 3/8"	DRIVE 1/2"	🗄️	📄	📌	📅	📍
475254W	12	T10 to T30	T40 to T60	T60	Plastic organizer	1	✓		

### 1/4" AND 3/8" DRIVE TORX FEMALE BIT SOCKET SET



**7**  
PIECES



•Forged in one piece

ITEM	PIECES	DRIVE 1/4"	DRIVE 3/8"	🗄️	📄	📌	📅	📍
4752E	7	E6 to E8	E10 to E16	Plastic organizer	1	✓		

### 1/4" AND 3/8" DRIVE TORX BIT SOCKET SET



**9**  
PIECES



ITEM	PIECES	DRIVE 1/4"	DRIVE 3/8"	🗄️	📄	📌	📅	📍
F4451T	9	T10 to T30	T40 to T50	Blister	1	✓		

HAND SOCKETS AND ACCESSORIES

## DRIVE HEXAGONAL BIT SOCKET SET

### 1/4" DRIVE FEMALE TORX SOCKET SET



**7**  
PIECES



ITEM	PIECES	DRIVE 1/4"	DRIVE 3/8"	☑	☑ AVAILABLE
F4451E	7	E6 to E8	E10 to E16	Blister	1 ✓

### 3/8" AND 1/2" DRIVE IMPACT SAE HEXAGONAL BIT SOCKET SET



**10**  
PIECES



ITEM	PIECES	DRIVE 3/8"	DRIVE 1/2"	☑	☑ AVAILABLE
5254HM	10	6	3	Metal box 4725	1 On Request

### 1/4" DRIVE SOCKET SET WITH ACCESSORIES



**25**  
PIECES



ITEM	PIECES	☑	☑	☑	☑ AVAILABLE
4700CM	25	18	6	Metal box 5396	1 ✓

### 1/4" DRIVE SOCKET SET WITH ACCESSORIES



**15**  
PIECES



ITEM	PIECES	☑	☑	☑	☑ AVAILABLE
4700P	15	13	2	Plastic case	1 ✓

### 3/8" AND 1/2" DRIVE SAE HEXAGONAL BIT SOCKET SET



**11**  
PIECES



ITEM	PIECES	DRIVE 3/8"	DRIVE 1/2"	☑	☑ AVAILABLE
5254H	11	7	3	Metal box 4725	1 On Request

### 1/4" DRIVE SOCKET SETS WITH ACCESSORIES

#### 1/4" DRIVE SOCKET SET WITH ACCESSORIES



**44**  
PIECES



ITEM	PIECES	☑	☑	☑	☑ AVAILABLE
4700A	44	40	3	Metal box 5396	1 ✓

#### 1/4" DRIVE SOCKET SET WITH ACCESSORIES



**15**  
PIECES



ITEM	PIECES	☑	☑	☑	☑ AVAILABLE
4700PM	15	13	2	Plastic case	1 ✓

#### 1/4" DRIVE SOCKET SET WITH ACCESSORIES



**70**  
PIECES



ITEM	PIECES	☑	☑	☑	☑ AVAILABLE
4701CD	70	32	6	32	Plastic case 1 On Request

# 03 HAND SOCKETS AND ACCESSORIES

## 1/4" DRIVE SOCKET SETS WITH ACCESSORIES

### 1/4" DRIVE SOCKET SET WITH ACCESSORIES

INDUSTRIAL DUTY INCHES METRIC 1/4" 6 6

30 PIECES



ITEM	PIECES	SOCKET	RATCHET	SCREWDRIVER	CASE	AVAILABLE
4700CB	30	27	3		Plastic case	1 On Request

### 1/4" DRIVE SOCKET SET WITH ACCESSORIES

PROFESSIONAL USE INCHES METRIC 1/4" 6 6

15 PIECES



ITEM	PIECES	SOCKET	RATCHET	SCREWDRIVER	CASE	AVAILABLE
F4400M	15	13	2		Plastic box	1 ✓

### 1/4" DRIVE SAE SOCKET SET WITH ACCESSORIES

HEAVY DUTY INCHES 1/4" 6

20 PIECES



ITEM	PIECES	SOCKET	RATCHET	SCREWDRIVER	CASE	AVAILABLE
4700CA	20	14	5		Metal box 5396	1 ✓

### 1/4" DRIVE SAE SOCKET SET WITH ACCESSORIES

HEAVY DUTY INCHES 1/4" 6

16 PIECES



ITEM	PIECES	SOCKET	RATCHET	SCREWDRIVER	CASE	AVAILABLE
47112	16	10	5		Metal box 4725	1 ✓

### 1/4" DRIVE SOCKET SET WITH ACCESSORIES

PROFESSIONAL USE INCHES METRIC 1/4" 6 6

15 PIECES



ITEM	PIECES	SOCKET	RATCHET	SCREWDRIVER	CASE	AVAILABLE
F4400	15	13	2		Plastic box	1 ✓

### 1/4" DRIVE SAE SOCKET SET WITH ACCESSORIES

HEAVY DUTY INCHES 1/4" 6

26 PIECES



ITEM	PIECES	SOCKET	RATCHET	SCREWDRIVER	CASE	AVAILABLE
47116	26	20	5		Metal box 5396	1 ✓

### 1/4" DRIVE SAE SOCKET SET WITH ACCESSORIES

HEAVY DUTY INCHES 1/4" 12

17 PIECES



ITEM	PIECES	SOCKET	RATCHET	SCREWDRIVER	CASE	AVAILABLE
47111	17	11	5		Metal box 4725	1 ✓

### 1/4" DRIVE SAE SOCKET SET WITH ACCESSORIES

HEAVY DUTY INCHES 1/4" 12

13 PIECES



ITEM	PIECES	SOCKET	RATCHET	SCREWDRIVER	CASE	AVAILABLE
47110	13	10	2		Metal box 4725	1 ✓

HAND SOCKETS AND ACCESSORIES

## 1/4" DRIVE SOCKET SETS WITH ACCESSORIES

### 1/4" DRIVE SAE SOCKET SET WITH ACCESSORIES

HEAVY DUTY INCHES 1/4" 6

12  
PIECES



ITEM	PIECES	🔩	🔧	📦	📦 AVAILABLE
4700C	12	9	2	Metal box 4725	1 ✓

### 1/4" DRIVE SAE SOCKET SET WITH ACCESSORIES

PROFESSIONAL USE INCHES 1/4" 6

10  
PIECES



NEW

ITEM	PIECES	🔩	🔧	📦	📦 AVAILABLE
A03S	10	8	2	Rack	1 ✓

### 1/4" DRIVE METRIC SOCKET SET WITH ACCESSORIES

HEAVY DUTY METRIC 1/4" 6

18  
PIECES



ITEM	PIECES	🔩	🔧	📦	📦 AVAILABLE
47205	18	12	5	Metal box 4725	1 ✓

### 1/4" DRIVE METRIC SOCKET SET WITH ACCESSORIES

PROFESSIONAL USE METRIC 1/4" 6

10  
PIECES



NEW

ITEM	PIECES	🔩	🔧	📦	📦 AVAILABLE
A03M	10	8	2	Rack	1 ✓

### 1/4" DRIVE SAE SOCKET SET WITH ACCESSORIES

HEAVY DUTY INCHES 1/4" 6

12  
PIECES



ITEM	PIECES	🔩	🔧	📦	📦 AVAILABLE
47101	12	11	1	Rack	1 On Request

### 1/4" DRIVE METRIC SOCKET SET WITH ACCESSORIES

HEAVY DUTY METRIC 1/4" 6

30  
PIECES



ITEM	PIECES	🔩	🔧	📦	📦 AVAILABLE
47206	30	24	5	Metal box 5396	1 ✓

### 1/4" DRIVE METRIC SOCKET SET WITH ACCESSORIES

HEAVY DUTY METRIC 1/4" 6

12  
PIECES



ITEM	PIECES	🔩	🔧	📦	📦 AVAILABLE
47201	12	11	1	Rack	1 ✓

## 3/8" DRIVE SOCKET SETS WITH ACCESSORIES

### 3/8" DRIVE SOCKET SET WITH ACCESSORIES

HEAVY DUTY INCHES 3/8" 12 12

54  
PIECES



ITEM	PIECES	🔩	🔧	📦	📦 AVAILABLE
5200PA	54	50	4	Plastic case	1 ✓

# 03 HAND SOCKETS AND ACCESSORIES

## 3/8" DRIVE SOCKET SET WITH ACCESSORIES

3/8" DRIVE SOCKET SET WITH ACCESSORIES

HEAVY DUTY INCHES 3/8" 6 6 METRIC

48 PIECES



ITEM	PIECES	Socket	Ratchet	Accessories	Case	AVAILABLE
5200B	48	44	4		Metal box 5495	1 ✓

3/8" DRIVE SOCKET SET WITH ACCESSORIES

INDUSTRIAL DUTY INCHES 3/8" 12 12 METRIC

33 PIECES



ITEM	PIECES	Socket	Ratchet	Accessories	Case	AVAILABLE
5200CB	33	28	5		Plastic case	1 On Request

3/8" DRIVE SOCKET SET WITH ACCESSORIES

PROFESSIONAL USE INCHES 3/8" 12 12 METRIC

21 PIECES



ITEM	PIECES	Socket	Ratchet	Accessories	Case	AVAILABLE
A02C	21	20	1		Rack	1 ✓

3/8" DRIVE SAE SOCKET SET WITH ACCESSORIES

HEAVY DUTY INCHES 3/8" 6

25 PIECES



ITEM	PIECES	Socket	Ratchet	Accessories	Case	AVAILABLE
5200CL	25	19	5		Metal box 5396	1 ✓

3/8" DRIVE SOCKET SET WITH ACCESSORIES

INDUSTRIAL DUTY INCHES 3/8" 6 6 METRIC

47 PIECES



ITEM	PIECES	Socket	Ratchet	Accessories	Case	AVAILABLE
5201CD	47	20	5	22	Plastic case	1 On Request

3/8" DRIVE SOCKET SET WITH ACCESSORIES

PROFESSIONAL USE INCHES 3/8" 6 6 METRIC

38 PIECES



ITEM	PIECES	Socket	Ratchet	Accessories	Case	AVAILABLE
F510C	38	30	7		Plastic box CPSC20	1 ✓

3/8" DRIVE SAE SOCKET SET WITH ACCESSORIES

HEAVY DUTY INCHES 3/8" 12 6

28 PIECES



ITEM	PIECES	Socket	Ratchet	Accessories	Case	AVAILABLE		
5003B	28	16	2	5	2	2	Metal box 5495	1 ✓

3/8" DRIVE SAE SOCKET SET WITH ACCESSORIES

HEAVY DUTY INCHES 3/8" 12

23 PIECES



ITEM	PIECES	Socket	Ratchet	Accessories	Case	AVAILABLE
52136	23	18	4		Metal box 5396	1 ✓

HAND SOCKETS AND ACCESSORIES



## 3/8" DRIVE SOCKET SETS WITH ACCESSORIES

### 3/8" DRIVE SAE SOCKET SET WITH ACCESSORIES

HEAVY DUTY INCHES 3/8" 6

23  
PIECES



ITEM	PIECES	SOCKET	WRENCH	BAR	AVAILABLE
52134	23	18	4	Metal box 5396	1 ✓

### 3/8" DRIVE SAE SOCKET SET WITH ACCESSORIES

HEAVY DUTY INCHES 3/8" 12

13  
PIECES



ITEM	PIECES	SOCKET	WRENCH	BAR	AVAILABLE
52130	13	9	3	Metal box 4725	1 ✓

### 3/8" DRIVE SAE SOCKET SET WITH ACCESSORIES

HEAVY DUTY INCHES 3/8" 12

13  
PIECES



ITEM	PIECES	SOCKET	WRENCH	BAR	AVAILABLE
5200LP	13	12	1	Metal box	1 ✓

### 3/8" DRIVE SAE SOCKET SET WITH ACCESSORIES

PROFESSIONAL USE INCHES 3/8" 12

10  
PIECES



ITEM	PIECES	SOCKET	WRENCH	BAR	AVAILABLE
A02S	10	8	2	Rack	1 ✓

### 3/8" DRIVE SAE SOCKET SET WITH ACCESSORIES

HEAVY DUTY INCHES 3/8" 12

19  
PIECES



ITEM	PIECES	SOCKET	WRENCH	BAR	AVAILABLE
5200AC	19	12	6	Metal box 5495	1 ✓

### 3/8" DRIVE SAE SOCKET SET WITH ACCESSORIES

HEAVY DUTY INCHES 3/8" 6

13  
PIECES



ITEM	PIECES	SOCKET	WRENCH	BAR	AVAILABLE
52128	13	9	3	Metal box 4725	1 ✓

### 3/8" DRIVE SAE SOCKET SET WITH ACCESSORIES

HEAVY DUTY INCHES 3/8" 12

10  
PIECES



ITEM	PIECES	SOCKET	WRENCH	BAR	AVAILABLE
JBUA02S	10	8	2	Rack	1 ✓

### 3/8" DRIVE METRIC DEEP SOCKET SET WITH ACCESSORIES

HEAVY DUTY METRIC 3/8" 6

30  
PIECES



ITEM	PIECES	SOCKET	WRENCH	BAR	AVAILABLE
52220	30	24	5	Metal box 5495	1 ✓

# 03 HAND SOCKETS AND ACCESSORIES

## 3/8" DRIVE SOCKET SETS WITH ACCESSORIES

### 3/8" DRIVE METRIC DEEP SOCKET SET WITH ACCESSORIES

HEAVY DUTY METRIC 3/8" 12

30  
PIECES



ITEM	PIECES				AVAILABLE
52222	30	24	5	Metal box 5495	1 ✓

### 3/8" DRIVE METRIC SOCKET SET WITH ACCESSORIES

HEAVY DUTY METRIC 3/8" 12

17  
PIECES



ITEM	PIECES				AVAILABLE
52218	17	14	2	Metal box 4725	1 ✓

### 3/8" DRIVE METRIC SOCKET SET WITH ACCESSORIES

INDUSTRIAL DUTY METRIC 3/8" 12

13  
PIECES



ITEM	PIECES				AVAILABLE
5200LPM	13	12	1	Metal box	1 ✓

### 3/8" DRIVE METRIC SOCKET SET WITH ACCESSORIES

HEAVY DUTY METRIC 3/8" 12

21  
PIECES



ITEM	PIECES				AVAILABLE
5200M	21	14	6	Metal box 5495	1 ✓

### 3/8" DRIVE METRIC SOCKET SET WITH ACCESSORIES

HEAVY DUTY METRIC 3/8" 12

10  
PIECES



ITEM	PIECES				AVAILABLE
JBUA02M	10	8	2	Rack	1 ✓

### 3/8" DRIVE METRIC SOCKET SET WITH ACCESSORIES

PROFESSIONAL USE METRIC 3/8" 12

10  
PIECES



ITEM	PIECES				AVAILABLE
A02M	10	8	2	Rack	1 ✓

## 1/2" DRIVE SOCKET SETS WITH ACCESSORIES

### 1/2" DRIVE SOCKET SET WITH ACCESSORIES

HEAVY DUTY INCHES METRIC 1/2" 12 12

60  
PIECES



ITEM	PIECES				AVAILABLE
5400PD	60	55	5	Plastic case	1 ✓

### 1/2" DRIVE SOCKET SET WITH ACCESSORIES

HEAVY DUTY INCHES METRIC 1/2" 12 12

44  
PIECES



ITEM	PIECES				AVAILABLE
5400SM	44	37	6	Metal box 5495	1 ✓

HAND SOCKETS AND ACCESSORIES

## 1/2" DRIVE SOCKET SETS WITH ACCESSORIES

### 1/2" DRIVE SOCKET SET WITH ACCESSORIES

INDUSTRIAL DUTY INCHES 1/2" 6 6 METRIC

42  
PIECES



ITEM	PIECES	Socket	Wrench	Case	AVAILABILITY
5400CB	42	35	7	Plastic case	1 On Request

### 1/2" DRIVE SOCKET SET WITH ACCESSORIES

INDUSTRIAL DUTY INCHES 1/2" 6 6 METRIC

30  
PIECES



ITEM	PIECES	Socket	Wrench	Case	AVAILABILITY
5401CD	30	26	4	Plastic case	1 On Request

### 1/2" DRIVE SOCKET SET WITH ACCESSORIES

PROFESSIONAL USE INCHES 1/2" 12 6 12 METRIC

60  
PIECES



NEW

ITEM	PIECES	Socket	Wrench	Case	AVAILABILITY
F58C	60	55	5	Plastic case	1 On Request



### 1/2" DRIVE SAE SOCKET SET WITH ACCESSORIES

HEAVY DUTY INCHES 1/2" 12 6

43  
PIECES



ITEM	PIECES	Socket	Wrench	Case	AVAILABILITY
5400G	43	35	7	Metal box 5696	1 ✓

### 1/2" DRIVE SAE SOCKET SET WITH ACCESSORIES

HEAVY DUTY INCHES 1/2" 12 6

43  
PIECES



ITEM	PIECES	Socket	Wrench	Case	AVAILABILITY
54P42	43	35	7	Plastic box CPUC20	1 ✓

### 1/2" DRIVE SAE SOCKET SET WITH ACCESSORIES

HEAVY DUTY INCHES 1/2" 12 6

28  
PIECES



ITEM	PIECES	Socket	Wrench	Case	AVAILABILITY
5404B	28	14	1 7 5	Metal box 5495	1 ✓

### 1/2" DRIVE SAE SOCKET SET WITH ACCESSORIES

HEAVY DUTY INCHES 1/2" 12

28  
PIECES



ITEM	PIECES	Socket	Wrench	Case	AVAILABILITY
54124	28	20	7	Metal box 5495	1 ✓

HAND SOCKETS AND ACCESSORIES

# 03 HAND SOCKETS AND ACCESSORIES

## 1/2" DRIVE SAE SOCKET SET WITH ACCESSORIES

**HEAVY DUTY** INCHES 1/2" 12

**25** PIECES

URREA  
SUPERIOR QUALITY AFFORDABLE TOOLS

ITEM	PIECES	INCHES	DRIVE	ACCESSORIES	CASE	AVAILABLE
5400PC	25	1/2"	12	5	Plastic case	1 ✓

## 1/2" DRIVE SAE SOCKET SET WITH ACCESSORIES

**HEAVY DUTY** INCHES 1/2" 12

**20** PIECES

URREA  
SUPERIOR QUALITY AFFORDABLE TOOLS

ITEM	PIECES	INCHES	DRIVE	ACCESSORIES	CASE	AVAILABLE
5400PB	20	1/2"	12	4	Plastic case	1 ✓

## 1/2" DRIVE SAE SOCKET SET WITH ACCESSORIES

**HEAVY DUTY** INCHES 1/2" 12

**19** PIECES

URREA  
SUPERIOR QUALITY AFFORDABLE TOOLS

ITEM	PIECES	INCHES	DRIVE	ACCESSORIES	CASE	AVAILABLE
54120	19	1/2"	12	3	Metal box 5495	1 ✓

## 1/2" DRIVE SAE SOCKET SET WITH ACCESSORIES

**HEAVY DUTY** INCHES 1/2" 6

**19** PIECES

URREA  
SUPERIOR QUALITY AFFORDABLE TOOLS

ITEM	PIECES	INCHES	DRIVE	ACCESSORIES	CASE	AVAILABLE
54122	19	1/2"	6	3	Metal box 5495	1 ✓

## 1/2" DRIVE SAE SOCKET SET WITH ACCESSORIES

**HEAVY DUTY** INCHES 1/2" 12

**17** PIECES

URREA  
SUPERIOR QUALITY AFFORDABLE TOOLS

ITEM	PIECES	INCHES	DRIVE	ACCESSORIES	CASE	AVAILABLE
5400AB	17	1/2"	12	6	Metal box 5495	1 ✓

## 1/2" DRIVE SAE SOCKET SET WITH ACCESSORIES

**HEAVY DUTY** INCHES 1/2" 12

**17** PIECES

URREA  
SUPERIOR QUALITY AFFORDABLE TOOLS

ITEM	PIECES	INCHES	DRIVE	ACCESSORIES	CASE	AVAILABLE
5400P	17	1/2"	12	4	Plastic case	1 ✓

## 1/2" DRIVE SAE SOCKET SET WITH ACCESSORIES

**HEAVY DUTY** INCHES 1/2" 12

**15** PIECES

URREA  
SUPERIOR QUALITY AFFORDABLE TOOLS

ITEM	PIECES	INCHES	DRIVE	ACCESSORIES	CASE	AVAILABLE
5300A	15	1/2"	12	3	Metal box 5495	1 ✓

## 1/2" DRIVE SAE SOCKET SET WITH ACCESSORIES

**HEAVY DUTY** INCHES 1/2" 12

**13** PIECES

URREA  
SUPERIOR QUALITY AFFORDABLE TOOLS

ITEM	PIECES	INCHES	DRIVE	ACCESSORIES	CASE	AVAILABLE
54116	13	1/2"	12	2	Metal box 5396	1 ✓

## 1/2" DRIVE SOCKET SETS WITH ACCESSORIES

### 1/2" DRIVE SAE SOCKET SET WITH ACCESSORIES



HEAVY DUTY

INCHES 1/2" 12

10  
PIECES



URREA



ITEM	PIECES	INCHES	DRIVE	ACCESSORIES	PACKAGING	AVAILABLE
JBUA01S	10	1/2"	12	8	Rack	1 ✓

### 1/2" DRIVE SAE SOCKET SET WITH ACCESSORIES



PROFESSIONAL USE INCHES 1/2" 12

27  
PIECES



SURTEK



NEW

ITEM	PIECES	INCHES	DRIVE	ACCESSORIES	PACKAGING	AVAILABLE
F581S	27	1/2"	12	20	Plastic case	1 On Request

### 1/2" DRIVE SAE SOCKET SET WITH ACCESSORIES



PROFESSIONAL USE INCHES 1/2" 12

20  
PIECES



SURTEK



ITEM	PIECES	INCHES	DRIVE	ACCESSORIES	PACKAGING	AVAILABLE
F5800B	20	1/2"	12	16	Plastic box	1 ✓

### 1/2" DRIVE SAE SOCKET SET WITH ACCESSORIES



PROFESSIONAL USE INCHES 1/2" 12

17  
PIECES



SURTEK



ITEM	PIECES	INCHES	DRIVE	ACCESSORIES	PACKAGING	AVAILABLE
F5800	17	1/2"	12	13	Plastic case	1 ✓

### 1/2" DRIVE SAE SOCKET SET WITH ACCESSORIES



PROFESSIONAL USE INCHES 1/2" 12 6

43  
PIECES



SURTEK



NEW

ITEM	PIECES	INCHES	DRIVE	ACCESSORIES	PACKAGING	AVAILABLE
F58S	43	1/2"	12	36	Plastic case	1 On Request

### 1/2" DRIVE SAE SOCKET SET WITH ACCESSORIES



PROFESSIONAL USE INCHES 1/2" 12

25  
PIECES



SURTEK



ITEM	PIECES	INCHES	DRIVE	ACCESSORIES	PACKAGING	AVAILABLE
F5800C	25	1/2"	12	20	Plastic case	1 On Request

### 1/2" DRIVE SAE SOCKET SET WITH ACCESSORIES



PROFESSIONAL USE INCHES 1/2" 12

18  
PIECES



SURTEK



NEW

ITEM	PIECES	INCHES	DRIVE	ACCESSORIES	PACKAGING	AVAILABLE
F09S	18	1/2"	12	14	Metal box TBO2	1 On Request

### 1/2" DRIVE SAE SOCKET SET WITH ACCESSORIES



PROFESSIONAL USE INCHES 1/2" 12

10  
PIECES



SURTEK



ITEM	PIECES	INCHES	DRIVE	ACCESSORIES	PACKAGING	AVAILABLE
A01S	10	1/2"	12	8	Rack	1 ✓

HAND SOCKETS AND ACCESSORIES

# 03 HAND SOCKETS AND ACCESSORIES

## 1/2" DRIVE SOCKET SETS WITH ACCESSORIES

### 1/2" DRIVE METRIC SOCKET SET WITH ACCESSORIES



**32**  
PIECES



ITEM	PIECES	🔩	🔧	📦	📦	📦	📦	📦	📦
54214A	32	27	4	Metal box 5495	1	✓	AVAILABLE		

### 1/2" DRIVE METRIC SOCKET SET WITH ACCESSORIES



**29**  
PIECES



ITEM	PIECES	🔩	🔧	📦	📦	📦	📦	📦	📦
5400M	29	22	6	Metal box 5495	1	✓	AVAILABLE		

### 1/2" DRIVE METRIC SOCKET SET WITH ACCESSORIES



**23**  
PIECES



ITEM	PIECES	🔩	🔧	📦	📦	📦	📦	📦	📦
54210H	23	17	5	Metal box 5495	1	✓	AVAILABLE		

### 1/2" DRIVE METRIC SOCKET SET WITH ACCESSORIES



**17**  
PIECES



ITEM	PIECES	🔩	🔧	📦	📦	📦	📦	📦	📦
5400PM	17	13	4	Plastic case	1	✓	AVAILABLE		

### 1/2" DRIVE METRIC SOCKET SET WITH ACCESSORIES



**29**  
PIECES



ITEM	PIECES	🔩	🔧	📦	📦	📦	📦	📦	📦
54P28	29	22	6	Plastic box CPUC20	1	✓	AVAILABLE		

### 1/2" DRIVE METRIC SOCKET SET WITH ACCESSORIES



**23**  
PIECES



ITEM	PIECES	🔩	🔧	📦	📦	📦	📦	📦	📦
54210	23	17	5	Metal box 5495	1	✓	AVAILABLE		

### 1/2" DRIVE METRIC SOCKET SET WITH ACCESSORIES



**20**  
PIECES



ITEM	PIECES	🔩	🔧	📦	📦	📦	📦	📦	📦
5400PBM	20	16	4	Plastic case	1	✓	AVAILABLE		

### 1/2" DRIVE METRIC SOCKET SET WITH ACCESSORIES



**17**  
PIECES



ITEM	PIECES	🔩	🔧	📦	📦	📦	📦	📦	📦
54208	17	14	2	Metal box 5396	1	✓	AVAILABLE		

HAND SOCKETS AND ACCESSORIES

## 1/2" DRIVE SOCKET SETS WITH ACCESSORIES

### 1/2" DRIVE METRIC SOCKET SET WITH ACCESSORIES



**17**  
PIECES



ITEM	PIECES	🗑️	🔧	📦	📄	📦 AVAILABLE
54208H	17	14	2	Metal box 5396	1	✓

### 1/2" DRIVE METRIC SOCKET SET WITH ACCESSORIES



**10**  
PIECES



ITEM	PIECES	🗑️	🔧	📦	📄	📦 AVAILABLE
JBUA01M	10	8	2	Rack	1	✓

### 1/2" DRIVE METRIC SOCKET SET WITH ACCESSORIES



**28**  
PIECES



NEW

ITEM	PIECES	🗑️	🔧	📦	📄	📦 AVAILABLE
F58M	28	22	6	Plastic case	1	On Request

### 1/2" DRIVE METRIC SOCKET SET WITH ACCESSORIES



**25**  
PIECES



ITEM	PIECES	🗑️	🔧	📦	📄	📦 AVAILABLE
F5800CM	25	20	5	Plastic case	1	On Request

### 1/2" DRIVE METRIC SOCKET SET WITH ACCESSORIES



**20**  
PIECES



ITEM	PIECES	🗑️	🔧	📦	📄	📦 AVAILABLE
F5800BM	20	16	4	Plastic case	1	✓

### 1/2" DRIVE METRIC SOCKET SET WITH ACCESSORIES



**17**  
PIECES



ITEM	PIECES	🗑️	🔧	📦	📄	📦 AVAILABLE
F5800M	17	13	4	Plastic case	1	On Request

### 1/2" DRIVE SAE SOCKET SET WITH ACCESSORIES



**21**  
PIECES



ITEM	PIECES	🗑️	🔧	📦	📄	📦 AVAILABLE
54P20	21	16	4	Plastic box CPUC20	1	✓

### 1/2" DRIVE METRIC SOCKET SET WITH ACCESSORIES



**18**  
PIECES



ITEM	PIECES	🗑️	🔧	📦	📄	📦 AVAILABLE
54P17M	18	13	4	Plastic box CPUC20	1	✓

# 03 HAND SOCKETS AND ACCESSORIES

## 1/2" DRIVE SOCKET SETS WITH ACCESSORIES

### 1/2" DRIVE METRIC SOCKET SET WITH ACCESSORIES



METRIC



SURTEK



10  
PIECES



ITEM	PIECES	🔩	🔧	📦	📄	📦 AVAILABLE
A01M	10	8	2	Rack	1	✓

### 3/4" DRIVE SAE SOCKET SET WITH ACCESSORIES



INCHES



URREA



24  
PIECES



ITEM	PIECES	🔩	🔧	📦	📄	📦 AVAILABLE
5500C	24	17	6	Metal box 5696	1	✓

### 3/4" DRIVE SAE SOCKET SET WITH ACCESSORIES



INCHES



URREA



17  
PIECES



ITEM	PIECES	🔩	🔧	📦	📄	📦 AVAILABLE
55100H	17	14	2	Metal box 5696	1	✓

### 3/4" DRIVE SAE SOCKET SET WITH ACCESSORIES



INCHES



SURTEK



22  
PIECES



ITEM	PIECES	🔩	🔧	📦	📄	📦 AVAILABLE
105605	22	17	5	Metal box	1	✓

## 3/4" DRIVE SOCKET SETS WITH ACCESSORIES

### 3/4" DRIVE SAE SOCKET SET WITH ACCESSORIES



INCHES



URREA



30  
PIECES



ITEM	PIECES	🔩	🔧	📦	📄	📦 AVAILABLE
55104	30	22	7	Metal box 5696	1	✓

### 3/4" DRIVE SAE SOCKET SET WITH ACCESSORIES



INCHES



URREA



21  
PIECES



ITEM	PIECES	🔩	🔧	📦	📄	📦 AVAILABLE
55102H	21	14	6	Metal box 5696	1	✓

### 3/4" DRIVE SAE SOCKET SET WITH ACCESSORIES



INCHES



URREA



12  
PIECES



ITEM	PIECES	🔩	🔧	📦	📄	📦 AVAILABLE
5500NR	12	8	3	Metal box 5696	1	✓

### 3/4" DRIVE METRIC SOCKET SET WITH ACCESSORIES



METRIC



URREA



29  
PIECES



ITEM	PIECES	🔩	🔧	📦	📄	📦 AVAILABLE
55202	29	22	6	Metal box 5696	1	✓

HAND SOCKETS AND ACCESSORIES



## 3/4" DRIVE SOCKET SETS WITH ACCESSORIES

### 3/4" DRIVE METRIC SOCKET SET WITH ACCESSORIES



**20**  
PIECES



ITEM	PIECES	🔩	🔑	📦	📄	📦 AVAILABLE
55200	20	15	4	Metal box 5696	1	✓

### 3/4" DRIVE METRIC SOCKET SET WITH ACCESSORIES



**20**  
PIECES



ITEM	PIECES	🔩	🔑	📦	📄	📦 AVAILABLE
55200H	20	15	4	Metal box 5696	1	✓

## 1" DRIVE SOCKET SETS WITH ACCESSORIES

### 1" DRIVE SAE SOCKET SET WITH ACCESSORIES



**28**  
PIECES



ITEM	PIECES	🔩	🔑	📦	📄	📦 AVAILABLE
57104	28	23	4	Metal box 5896	1	✓

### 1" DRIVE SAE SOCKET SET WITH ACCESSORIES



**21**  
PIECES



ITEM	PIECES	🔩	🔑	📦	📄	📦 AVAILABLE
57102	21	16	4	Metal box 5896	1	✓

### 1" DRIVE SAE SOCKET SET WITH ACCESSORIES



**16**  
PIECES



ITEM	PIECES	🔩	🔑	📦	📄	📦 AVAILABLE
5800A	16	13	2	Metal box 5896	1	✓

### 1" DRIVE SAE SOCKET SET WITH ACCESSORIES



**14**  
PIECES



ITEM	PIECES	🔩	🔑	📦	📄	📦 AVAILABLE
57100	14	11	2	Metal box 5896	1	✓

**URREA**  
SUPERIOR QUALITY AFFORDABLE TOOLS



**SUPERIOR**  
*Versatility*

usa.urrea.com

3/4" DRIVE METRIC SOCKET SET WITH ACCESSORIES

## 1/4" DRIVE SOCKETS

### 1/4" DRIVE SAE SOCKETS 12 AND 6 POINT



HAND SOCKETS AND ACCESSORIES



TYPE I



TYPE II

- Made of Chrome vanadium steel.
- Super drive® design.
- Nickel - Chrome plated.
- Exceed FEDERAL GGG-W-641E, ASME B107.1, ISO 3315, SAE AS 4283, DIN 3124 standards.

#### SOCKETS SETS

	6	6
ITEM	47106	47204
PIECES	10	9
PACKING		
☐	1	1
AVAILABLE	✓	✓

#### INDIVIDUAL SOCKETS

OPENING SIZE	ITEM	TYPE	LENGTH	NUT END OUTSIDE DIAMETER	DRIVE END OUTSIDE DIAMETER	NUT DEPTH	☐	AVAILABLE
5/32"	4705T 4705	I	1"	1/4"	15/32"	1/4"	6	✓
3/16"	4706T 4706	I	1"	5/16"	15/32"	1/4"	6	✓
7/32"	4707T 4707	I	1"	11/32"	15/32"	1/4"	6	✓
1/4"	4708T 4708	I	1"	23/64"	15/32"	5/16"	6	✓
9/32"	4709T 4709	I	1"	13/32"	15/32"	11/32"	6	✓
5/16"	4710T 4710	II	1"	15/32"	15/32"	11/32"	6	✓
11/32"	4711T 4711	II	1"	1/2"	1/2"	11/32"	6	✓
3/8"	4712T 4712	II	1"	35/64"	35/64"	11/32"	6	✓
7/16"	4714T 4714	II	1"	5/8"	5/8"	7/16"	6	✓
1/2"	4716T 4716	II	1"	11/16"	11/16"	7/16"	6	✓
9/16"	4718T 4718	II	1"	3/4"	3/4"	7/16"	6	✓

### 1/4" DRIVE SAE SOCKETS 6 POINT



TYPE I



TYPE II

- Made of Chrome vanadium steel.
- Super drive® design.
- Exceeds ASME B107.110 2012, DIN 3124 standard.

#### INDIVIDUAL SOCKETS

OPENING SIZE	ITEM	TYPE	LENGTH	NUT END OUTSIDE DIAMETER	DRIVE END OUTSIDE DIAMETER	NUT DEPTH	☐	AVAILABLE
5/32"	4405	I	1"	1/4"	15/32"	1/4"	6	✓
3/16"	4406	I	1"	5/16"	15/32"	1/4"	6	✓
7/32"	4407	I	1"	11/32"	15/32"	1/4"	6	✓
1/4"	4408	I	1"	11/32"	15/32"	5/16"	6	✓
9/32"	4409	I	1"	13/32"	15/32"	11/32"	6	✓
5/16"	4410	II	1"	15/32"	15/32"	11/32"	6	✓
11/32"	4411	II	1"	1/2"	1/2"	11/32"	6	✓
3/8"	4412	II	1"	17/32"	17/32"	11/32"	6	✓
7/16"	4414	II	1"	5/8"	5/8"	7/16"	6	✓
1/2"	4416	II	1"	11/16"	11/16"	7/16"	6	✓

#### SOCKET SET

	6
ITEM	S05S
PIECES	10
PACKING	
☐	1
AVAILABLE	✓

## 1/4" DRIVE SOCKETS

### 1/4" DRIVE METRIC SOCKETS 6 POINT



SHORT SOCKET

METRIC



URREA



TYPE I



TYPE II

- Made of Chrome vanadium steel.
- Super drive® design.
- Nickel - Chrome plated.
- Exceed FEDERAL GGG-W-641E, ASME B107.1, ISO 3315, SAE AS 4283, DIN 3124 standards.

INDIVIDUAL SOCKETS								PACKING		SOCKET SET	
OPENING SIZE	ITEM	TYPE	LENGTH	NUT END OUTSIDE DIAMETER	DRIVE END OUTSIDE DIAMETER	NUT DEPTH	AVAILABLE	ITEM	PIECES	SOCKET SET	ITEM
4 mm	4704M	I	1"	1/4"	15/32"	1/4"	6	✓	1	47207	6
4.5 mm	47045M	I	1"	9/32"	15/32"	1/4"	6	✓	9		6
5 mm	4705M	I	1"	5/16"	15/32"	1/4"	6	✓			6
5.5 mm	47055M	I	1"	5/16"	15/32"	1/4"	6	✓			6
6 mm	4706M	I	1"	11/32"	15/32"	5/16"	6	✓			6
7 mm	4707M	I	1"	13/32"	15/32"	11/32"	6	✓			6
8 mm	4708M	I	1"	15/32"	15/32"	11/32"	6	✓			6
9 mm	4709M	II	1"	1/2"	15/32"	11/32"	6	✓			6
10 mm	4710M	II	1"	17/32"	17/32"	11/32"	6	✓			6
11 mm	4711M	II	1"	5/8"	5/8"	7/16"	6	✓			6
12 mm	4712M	II	1"	21/32"	21/32"	7/16"	6	✓			6
13 mm	4713M	II	1"	11/16"	11/16"	7/16"	6	✓			6
14 mm	4714M	II	1"	3/4"	3/4"	7/16"	6	✓			6
15 mm	4715M	II	1"	13/16"	13/16"	7/16"	6	✓			6

### 1/4" DRIVE METRIC SOCKETS 6 POINT



SHORT SOCKET

METRIC



SURTEK



TYPE I



TYPE II

- Made of Chrome vanadium steel.
- Super drive® design.
- Exceeds ASME B107.110 2012 , DIN 3124 standard.

INDIVIDUAL SOCKETS								PACKING		SOCKET SET	
OPENING SIZE	ITEM	TYPE	LENGTH	NUT END OUTSIDE DIAMETER	DRIVE END OUTSIDE DIAMETER	NUT DEPTH	AVAILABLE	ITEM	PIECES	SOCKET SET	ITEM
4 mm	4404M	I	1"	1/4"	15/32"	1/4"	6	✓	1	S05M	6
5 mm	4405M	I	1"	5/16"	15/32"	1/4"	6	✓	10		6
6 mm	4406M	I	1"	11/32"	15/32"	5/16"	6	✓			6
7 mm	4407M	II	1"	13/32"	15/32"	11/32"	6	✓			6
8 mm	4408M	II	1"	15/32"	15/32"	11/32"	6	✓			6
9 mm	4409M	II	1"	1/2"	15/32"	11/32"	6	✓			6
10 mm	4410M	II	1"	17/32"	17/32"	11/32"	6	On Request			6
11 mm	4411M	II	1"	5/8"	5/8"	7/16"	6	✓			6
12 mm	4412M	II	1"	21/32"	21/32"	7/16"	6	✓			6
13 mm	4413M	II	1"	11/16"	11/16"	7/16"	6	✓			6

## 1/4" DRIVE SOCKETS

### 1/4" DRIVE SAE DEEP SOCKETS 6 POINT

URREA



DEEP SOCKET

INCHES



HAND SOCKETS AND ACCESSORIES



TYPE I



TYPE II

- Made of Chrome vanadium steel.
- Super drive® design.
- Nickel - Chrome plated.
- Exceed FEDERAL GGG-W-641E, ASME B107.1, ISO 3315, SAE AS 4283, DIN 3124 standards.



INDIVIDUAL SOCKETS



OPENING SIZE	ITEM	TYPE	LENGTH	NUT END OUTSIDE DIAMETER	DRIVE END OUTSIDE DIAMETER	NUT DEPTH	AVAILABLE
3/16"	4706L	I	2"	5/16"	15/32"	1/4"	✓
7/32"	4707L	I	2"	11/32"	15/32"	1/4"	✓
1/4"	4708L	I	2"	3/8"	15/32"	5/16"	✓
9/32"	4709L	I	2"	13/32"	15/32"	17/32"	•
5/16"	4710L	II	2"	15/32"	15/32"	17/32"	•
11/32"	4711L	II	2"	1/2"	1/2"	17/32"	•
3/8"	4712L	II	2"	9/16"	9/16"	17/32"	•
7/16"	4714L	II	2"	5/8"	5/8"	13/16"	•
1/2"	4716L	II	2"	23/32"	23/32"	13/16"	•
9/16"	4718L	II	2"	3/4"	3/4"	13/16"	•

SOCKET SET	
ITEM	47102
PIECES	8
PACKING	
AVAILABLE	✓

### 1/4" DRIVE SAE DEEP SOCKETS 6 POINT

SURTEK



DEEP SOCKET

INCHES



TYPE I



TYPE II

- Made of Chrome vanadium steel.
- Super drive® design.
- Exceeds ASME B107.110 2012, DIN 3124 standard.



INDIVIDUAL SOCKETS



OPENING SIZE	ITEM	TYPE	LENGTH	NUT END OUTSIDE DIAMETER	DRIVE END OUTSIDE DIAMETER	NUT DEPTH	AVAILABLE
1/4"	F4408HL	I	2"	11/32"	15/32"	5/16"	✓
9/32"	F4409HL	I	2"	13/32"	15/32"	17/32"	✓
5/16"	F4410HL	II	2"	15/32"	15/32"	17/32"	On Request
11/32"	F4411HL	II	2"	1/2"	1/2"	17/32"	✓
3/16"	F4412HL	II	2"	9/16"	9/16"	17/32"	•
7/16"	F4414HL	II	2"	5/8"	5/8"	13/16"	•
1/2"	F4416HL	II	2"	11/16"	11/16"	13/16"	•
9/16"	F4418HL	II	2"	3/4"	3/4"	13/16"	•

SOCKET SET	
ITEM	S13S
PIECES	8
PACKING	
AVAILABLE	✓

## 1/4" DRIVE SOCKETS

### 1/4" DRIVE METRIC DEEP SOCKETS 6 POINT



DEEP SOCKET

METRIC



URREA



TYPE I



TYPE II

- Made of Chrome vanadium steel.
- Super drive® design.
- Nickel - Chrome plated.
- Exceed FEDERAL GGG-W-641E, ASME B107.1, ISO 3315, SAE AS 4283, DIN 3124 standards.

INDIVIDUAL SOCKETS									
OPENING SIZE	ITEM	TYPE	LENGTH	NUT END OUTSIDE DIAMETER	DRIVE END OUTSIDE DIAMETER	NUT DEPTH	AVAILABLE	PACKING	SOCKET SET
4 mm	4704LM	I	2"	1/4"	15/32"	3/16"	6	✓	
5 mm	4705LM	I	2"	5/16"	15/32"	5/32"	6	✓	
5.5 mm	47055LM	I	2"	5/16"	15/32"	5/16"	6	✓	
6 mm	4706LM	I	2"	11/32"	15/32"	17/32"	6	✓	
7 mm	4707LM	I	2"	13/32"	15/32"	17/32"	6	✓	
8 mm	4708LM	I	2"	15/32"	15/32"	17/32"	6	✓	
9 mm	4709LM	II	2"	1/2"	17/32"	17/32"	6	✓	
10 mm	4710LM	II	2"	17/32"	17/32"	17/32"	6	✓	
11 mm	4711LM	II	2"	5/8"	5/8"	13/16"	6	✓	
12 mm	4712LM	II	2"	21/32"	21/32"	13/16"	6	✓	
13 mm	4713LM	II	2"	11/16"	11/16"	13/16"	6	✓	
14 mm	4714LM	II	2"	3/4"	3/4"	13/16"	6	✓	
15 mm	4715LM	II	2"	13/16"	13/16"	13/16"	6	✓	

### 1/4" DRIVE METRIC DEEP SOCKETS 6 POINT



DEEP SOCKET

METRIC



SURTEK



TYPE I



TYPE II

- Made of Chrome vanadium steel.
- Super drive® design.
- Exceeds ASME B107.110 2012, DIN 3124 standard.

INDIVIDUAL SOCKETS									
OPENING SIZE	ITEM	TYPE	LENGTH	NUT END OUTSIDE DIAMETER	DRIVE END OUTSIDE DIAMETER	NUT DEPTH	AVAILABLE	PACKING	SOCKET SET
6 mm	F4406HLM	I	2"	11/32"	15/32"	5/16"	6	✓	
7 mm	F4407HLM	I	2"	13/32"	15/32"	17/32"	6	✓	
8 mm	F4408HLM	II	2"	15/32"	15/32"	17/32"	6	✓	
9 mm	F4409HLM	II	2"	1/2"	17/32"	17/32"	6	✓	
10 mm	F4410HLM	II	2"	9/16"	9/16"	17/32"	6	✓	
11 mm	F4411HLM	II	2"	5/8"	5/8"	13/16"	6	✓	
12 mm	F4412HLM	II	2"	21/32"	21/32"	13/16"	6	✓	
13 mm	F4413HLM	II	2"	11/16"	11/16"	13/16"	6	✓	
14 mm	F4414HLM	II	2"	3/4"	3/4"	13/16"	6	✓	

# 03 HAND SOCKETS AND ACCESSORIES

## 1/4" DRIVE SOCKETS

### 1/4" DRIVE SAE FLEX SOCKETS 6 POINT

INDUSTRIAL DUTY FLEX SOCKET INCHES 1/4" 6 FLEXIBLE SOCKET



4771X

- Made of Chrome vanadium steel.
- Super drive® design.
- Ideal for removing screws in hard-to-reach places.
- Die bending angle greater than 65°.

#### INDIVIDUAL SOCKETS

OPENING SIZE	ITEM	LENGTH	NUT END OUTSIDE DIAMETER	DRIVE END OUTSIDE DIAMETER	NUT DEPTH	AVAILABLE
1/4"	4771X	1-3/8"	3/8"	9/16"	1/4"	6 ✓
5/16"	4772	1-3/8"	15/32"	9/16"	1/4"	6 ✓
7/16"	4774	1-29/64"	19/32"	9/16"	21/64"	6 ✓
1/2"	4775	1-29/64"	43/64"	9/16"	11/32"	6 ✓

### 1/4" DRIVE TORX BIT SOCKETS

HEAVY DUTY SHORT BIT TORX® 1/4"



473920W

- Made of high quality micro alloyed steel.
- Nickel - Chrome plated.

#### INDIVIDUAL SOCKETS

TIP SIZE	ITEM	TOTAL LENGTH	TOTAL BIT LENGTH	BIT LENGTH EXPOSED	DRIVE END OUTSIDE DIAMETER	AVAILABLE
T8	473908W	2"	1-5/16"	7/8"	1/2"	6 ✓
T10	473910W	2"	1-5/16"	7/8"	1/2"	6 ✓
T15	473915W	2"	1-5/16"	7/8"	1/2"	6 ✓
T20	473920W	2"	1-5/16"	7/8"	1/2"	6 ✓
T25	473925W	2"	1-5/16"	7/8"	1/2"	6 ✓
T27	473927W	2"	1-5/16"	7/8"	1/2"	6 ✓
T30	473930W	2"	1-5/16"	7/8"	1/2"	6 ✓

#### SOCKET SET

ITEM	4739C
PIECES	7
PACKING	1
AVAILABLE	✓



# SUPERIOR Access



usa.urrea.com

1/4" DRIVE SAE FLEX SOCKETS 6 POINT

## 1/4" DRIVE SOCKETS

### 1/4" DRIVE SAE HEXAGONAL BIT SOCKETS



SHORT BIT

HEXAGONAL

INCHES



URREA



4770-1/8



4770-1/4

- Made of high quality micro alloyed steel.
- Nickel - Chrome plated.

INDIVIDUAL SOCKETS								PACKING		SOCKET SET	
TIP SIZE	ITEM	TOTAL LENGTH	TOTAL BIT LENGTH	BIT LENGTH EXPOSED	DRIVE END OUTSIDE DIAMETER	AVAILABLE	SOCKET SET	ITEM	PIECES		
1/16"	4770-1/16	2"	1-5/16"	7/8"	1/2"	6	✓	4770-10	10		
5/64"	4770-5/64	2"	1-5/16"	7/8"	1/2"	6	✓				
3/32"	4770-3/32	2"	1-5/16"	7/8"	1/2"	6	✓				
7/64"	4770-7/64	2"	1-5/16"	7/8"	1/2"	6	✓				
1/8"	4770-1/8	2"	1-5/16"	7/8"	1/2"	6	✓				
9/64"	4770-9/64	2"	1-5/16"	7/8"	1/2"	6	✓				
5/32"	4770-5/32	2"	1-5/16"	7/8"	1/2"	6	✓				
3/16"	4770-3/16	2"	1-5/16"	7/8"	1/2"	6	✓				
7/32"	4770-7/32	2"	1-5/16"	7/8"	1/2"	6	✓				
1/4"	4770-1/4	2"	1-5/16"	7/8"	1/2"	6	✓				

### 1/4" DRIVE METRIC HEXAGONAL BIT SOCKETS



SHORT BIT

HEXAGONAL

METRIC



URREA



47703M



47706M

- Made of high quality micro alloyed steel.
- Nickel - Chrome plated.

INDIVIDUAL SOCKETS								PACKING		SOCKET SET	
TIP SIZE	ITEM	TOTAL LENGTH	TOTAL BIT LENGTH	BIT LENGTH EXPOSED	DRIVE END OUTSIDE DIAMETER	AVAILABLE	SOCKET SET	ITEM	PIECES		
2 mm	47702M	2"	1-5/16"	7/8"	1/2"	6	✓	4770-6	6		
2.5 mm	477025M	2"	1-5/16"	7/8"	1/2"	6	✓				
3 mm	47703M	2"	1-5/16"	7/8"	1/2"	6	✓				
4 mm	47704M	2"	1-5/16"	7/8"	1/2"	6	✓				
5 mm	47705M	2"	1-5/16"	7/8"	1/2"	6	✓				
6 mm	47706M	2"	1-5/16"	7/8"	1/2"	6	✓				

## 3/8" DRIVE SOCKETS

### 3/8" DRIVE SAE SOCKETS 12 AND 6 POINT

URREA



SHORT SOCKET

INCHES



TYPE I

TYPE II

- Made of high quality micro alloyed steel.
- Super drive® design.
- Nickel - Chrome plated.
- Exceed FEDERAL GGG-W-641E, ASME B107.1, ISO 3315, SAE AS 4283, DIN 3124 standards.

#### SOCKETS SETS

	12	12	6	6	6
ITEM	52124	52118	52126	52122	502HS
PIECES	13	10	13	10	8
PACKING					
AVAILABLE	✓	✓	✓	✓	✓

OPENING SIZE	ITEM		TYPE	LENGTH	NUT END OUTSIDE DIAMETER	DRIVE END OUTSIDE DIAMETER	NUT DEPTH	6	AVAILABLE					
	12	6							12	6	6	6	6	6
1/4"	5208	5208H	I	1-1/8"	7/16"	11/16"	3/8"	6	✓	•	•	•	•	•
5/16"	5210	5210H	I	1-1/8"	7/16"	11/16"	3/8"	6	✓	•	•	•	•	•
11/32"	5211	—	I	1-1/8"	1/2"	11/16"	3/8"	6	✓	•	•	•	•	•
3/8"	5212	5212H	I	1-1/8"	9/16"	11/16"	3/8"	6	✓	•	•	•	•	•
7/16"	5214	5214H	I	1-1/8"	5/8"	11/16"	3/8"	6	✓	•	•	•	•	•
1/2"	5216	5216H	II	1-1/8"	3/4"	3/4"	3/8"	6	✓	•	•	•	•	•
17/32"	5217	—	II	1-1/8"	3/4"	3/4"	3/8"	6	✓	•	•	•	•	•
9/16"	5218	5218H	II	1-1/8"	3/4"	3/4"	9/16"	6	✓	•	•	•	•	•
19/32"	5219	—	II	1-1/8"	13/16"	7/8"	9/16"	6	✓	•	•	•	•	•
5/8"	5220	5220H	II	1-3/16"	7/8"	7/8"	5/8"	6	✓	•	•	•	•	•
11/16"	5222	5222H	II	1-3/16"	15/16"	15/16"	5/8"	6	✓	•	•	•	•	•
3/4"	5224	5224H	II	1-3/16"	15/16"	1"	5/8"	6	✓	•	•	•	•	•
13/16"	5226	5226H	II	1-1/4"	1-1/8"	1-1/8"	5/8"	6	✓	•	•	•	•	•
7/8"	5228	5228H	II	1-1/4"	1-3/16"	1-3/16"	5/8"	6	✓	•	•	•	•	•
15/16"	5230	5230H	II	1-1/4"	1-1/4"	1-1/4"	5/8"	6	✓	•	•	•	•	•
1"	5232	5232H	II	1-1/4"	1-5/16"	1-5/16"	5/8"	6	✓	•	•	•	•	•

### 3/8" DRIVE SAE SOCKETS 12 POINT



SHORT SOCKET

INCHES



SURTEK



TYPE I

TYPE II

- Made of Chrome vanadium steel.
- SAE: AS954; ANSI/ASME: B107.1; FEDERAL: GGG-W-641E, GGG-W-1437 standards.

#### SOCKET SET

ITEM	6
ITEM	S06S
PIECES	10
PACKING	
AVAILABLE	✓

OPENING SIZE	ITEM		TYPE	LENGTH	NUT END OUTSIDE DIAMETER	DRIVE END OUTSIDE DIAMETER	NUT DEPTH	6	AVAILABLE	
	12	6							12	6
1/4"	F5108	—	I	1-1/8"	3/8"	5/8"	5/16"	6	✓	•
5/16"	F5110	—	I	1-1/8"	7/16"	5/8"	5/16"	v6	On Request	•
3/8"	F5112	—	I	1-1/8"	9/16"	5/8"	5/16"	6	On Request	•
7/16"	F5114	—	I	1-1/8"	9/16"	5/8"	5/16"	6	✓	•
1/2"	F5116	—	II	1-1/8"	5/8"	5/8"	5/16"	6	✓	•
9/16"	F5118	—	II	1-1/8"	5/8"	5/8"	7/16"	6	✓	•
5/8"	F5120	—	II	1-3/16"	7/8"	7/8"	7/16"	6	✓	•
11/16"	F5122	—	II	1-3/16"	15/16"	15/16"	7/16"	6	✓	•
3/4"	F5124	—	II	1-3/16"	1"	1"	1/2"	6	✓	•
13/16"	F5126	—	II	1-1/4"	1-1/16"	1-1/16"	1/2"	6	✓	•
7/8"	F5128	—	II	1-1/4"	1-1/8"	1-1/8"	1/2"	6	✓	•
15/16"	F5130	—	II	1-1/4"	1-1/4"	1-1/4"	1/2"	6	✓	•
1"	F5132	—	II	1-1/4"	1-5/16"	1-5/16"	1/2"	6	✓	•



## 3/8" DRIVE SOCKETS

### 3/8" DRIVE METRIC SOCKETS 12 AND 6 POINT



URREA



- Made of high quality micro alloyed steel.
- Super drive® design.
- Nickel - Chrome plated.
- Exceed FEDERAL GGG-W-641E, ASME B107.1

INDIVIDUAL SOCKETS								SOCKETS SETS				
OPENING SIZE	ITEM	TYPE	LENGTH	NUT END OUTSIDE DIAMETER	DRIVE END OUTSIDE DIAMETER	NUT DEPTH	AVAILABLE	52215	52216	52211	52212	S02HM
6 mm	5206M 5206HM	I	1-1/8"	7/16"	11/16"	3/8"	✓	•	•	•	•	•
7 mm	5207M 5207HM	I	1-1/8"	7/16"	11/16"	3/8"	✓	•	•	•	•	•
8 mm	5208M 5208HM	I	1-1/8"	1/2"	11/16"	3/8"	✓	•	•	•	•	•
9 mm	5209M 5209HM	I	1-1/8"	1/2"	11/16"	3/8"	✓	•	•	•	•	•
10 mm	5210M 5210HM	I	1-1/8"	9/16"	11/16"	3/8"	✓	•	•	•	•	•
11 mm	5211M 5211HM	I	1-1/8"	5/8"	11/16"	3/8"	✓	•	•	•	•	•
12 mm	5212M 5212HM	II	1-1/8"	11/16"	11/16"	3/8"	✓	•	•	•	•	•
13 mm	5213M 5213HM	II	1-1/8"	11/16"	11/16"	3/8"	✓	•	•	•	•	•
14 mm	5214M 5214HM	II	1-1/8"	3/4"	3/4"	9/16"	✓	•	•	•	•	•
15 mm	5215M 5215HM	II	1-1/8"	13/16"	13/16"	9/16"	✓	•	•	•	•	•
16 mm	5216M 5216HM	II	1-3/16"	7/8"	7/8"	9/16"	✓	•	•	•	•	•
17 mm	5217M 5217HM	II	1-3/16"	15/16"	15/16"	5/8"	✓	•	•	•	•	•
18 mm	5218M 5218HM	II	1-3/16"	1"	1"	5/8"	✓	•	•	•	•	•
19 mm	5219M 5219HM	II	1-3/16"	1-1/16"	1-1/16"	5/8"	✓	•	•	•	•	•
20 mm	5220M 5220HM	II	1-1/4"	1-1/16"	1-1/16"	5/8"	✓	•	•	•	•	•
21 mm	5221M 5221HM	II	1-1/4"	1-1/8"	1-1/8"	5/8"	✓	•	•	•	•	•
22 mm	5222M 5222HM	II	1-1/4"	1-3/16"	1-3/16"	5/8"	✓	•	•	•	•	•
23 mm	5223M 5223HM	II	1-1/4"	1-1/4"	1-1/4"	5/8"	✓	•	•	•	•	•
24 mm	5224M 5224HM	II	1-1/4"	1-1/4"	1-1/4"	5/8"	✓	•	•	•	•	•
25 mm	5225M 5225HM	II	1-1/4"	1-5/16"	1-5/16"	5/8"	✓	•	•	•	•	•
26 mm	5226M 5226HM	II	1-1/4"	1-5/16"	1-5/16"	5/8"	✓	•	•	•	•	•

### 3/8" DRIVE METRIC SOCKETS 12 POINT



SURTEK



NEW



- Made of Chrome vanadium steel.
- SAE: AS954; ANSI/ASME: B107.1; FEDERAL: GGG-W-641E, GGG-W-1437 standards.

INDIVIDUAL SOCKETS								SOCKET SET	
OPENING SIZE	ITEM	TYPE	LENGTH	NUT END OUTSIDE DIAMETER	DRIVE END OUTSIDE DIAMETER	NUT DEPTH	AVAILABLE	ITEM	SO66M
7 mm	F5107M	I	1-3/16"	13/32"	1/2"	5/16"	✓	SO66M	9
8 mm	F5108M	I	1-3/16"	7/16"	1/2"	5/16"	✓		
9 mm	F5109M	I	1-3/16"	1/2"	5/8"	13/32"	✓		
10 mm	F5110M	II	1-1/4"	1/2"	5/8"	13/32"	✓		
11 mm	F5111M	I	1-1/4"	9/16"	5/8"	7/16"	✓		
12 mm	F5112M	II	1-3/8"	5/8"	5/8"	7/16"	✓		
13 mm	F5113M	II	1-1/2"	11/16"	11/16"	1/2"	On Request		
14 mm	F5114M	II	1-1/2"	25/32"	25/32"	5/8"	On Request		
15 mm	F5115M	II	1-9/16"	7/8"	7/8"	5/8"	✓		
16 mm	F5116M	II	1-5/8"	7/8"	7/8"	5/8"	On Request		
17 mm	F5117M	II	1-5/8"	15/16"	15/16"	5/8"	✓		
18 mm	F5118M	II	1-3/4"	1"	1"	5/8"	✓		
19 mm	F5119M	II	1-3/4"	1"	1"	5/8"	✓		
20 mm	F5120M	II	1-7/8"	1"	1"	11/16"	✓		
21 mm	F5121M	II	2-1/16"	1-1/16"	1-1/16"	11/16"	✓		
22 mm	F5122M	II	2-1/16"	1-1/8"	1-1/8"	23/32"	✓		

## 3/8" DRIVE SOCKETS

### 3/8" DRIVE SAE DEEP SOCKETS 12 AND 6 POINT



HAND SOCKETS AND ACCESSORIES



TYPE I

TYPE II

- Made of high quality micro alloyed steel.
- Super drive® design.
- Nickel - Chrome plated.
- Exceed FEDERAL GGG-W-641E, ASME B107.1, ISO 3315, SAE AS 4283, DIN 3124 standards.

		SOCKETS SETS			
		12	12	6	6
ITEM		52112	52107	52114	52111
PIECES		13	10	13	10
PACKING					
AVAILABLE		✓	✓	✓	✓

INDIVIDUAL SOCKETS									
OPENING SIZE	ITEM	TYPE	LENGTH	NUT END OUTSIDE DIAMETER	DRIVE END OUTSIDE DIAMETER	NUT DEPTH		AVAILABLE	
1/4"	5008 5008H	I	2-1/2"	3/8"	11/16"	3/8"	6	✓	•
5/16"	5010 5010H	I	2-1/2"	7/16"	11/16"	5/8"	6	✓	•
3/8"	5012 5012H	I	2-1/2"	1/2"	11/16"	11/16"	6	✓	•
7/16"	5014 5014H	I	2-1/2"	5/8"	11/16"	1"	6	✓	•
1/2"	5016 5016H	II	2-1/2"	3/4"	3/4"	1"	6	✓	•
9/16"	5018 5018H	II	2-1/2"	3/4"	3/4"	1"	6	✓	•
5/8"	5020 5020H	II	2-1/2"	7/8"	7/8"	1"	6	✓	•
11/16"	5022 5022H	II	2-1/2"	15/16"	15/16"	1"	6	✓	•
3/4"	5024 5024H	II	2-1/2"	1-1/16"	1-1/16"	1"	6	✓	•
13/16"	5026 5026H	II	2-1/2"	1-1/8"	1-1/8"	1"	6	✓	•
7/8"	5028 5028H	II	2-1/2"	1-3/16"	1-3/16"	1"	6	✓	•
15/16"	5030 5030H	II	2-1/2"	1-1/4"	1-1/4"	1-1/16"	6	✓	•
1"	5032 5032H	II	2-1/2"	1-5/16"	1-5/16"	1-1/16"	6	✓	•

### 3/8" DRIVE SAE DEEP SOCKETS 6 POINT



TYPE I

TYPE II

- Made of Chrome vanadium steel.
- Exceed ASME B107.110 standards.

INDIVIDUAL SOCKETS									
OPENING SIZE	ITEM	TYPE	LENGTH	NUT END OUTSIDE DIAMETER	DRIVE END OUTSIDE DIAMETER	NUT DEPTH		AVAILABLE	
3/8"	F5112HL	I	2-1/2"	5/8"	5/8"	1-1/32"	6	✓	•
7/16"	F5114HL	I	2-1/2"	9/16"	11/16"	1-1/32"	6	✓	•
1/2"	F5116HL	II	2-1/2"	5/8"	11/16"	1-1/32"	6	✓	•
9/16"	F5118HL	II	2-1/2"	31/32"	31/32"	1-1/32"	6	✓	•
5/8"	F5120HL	II	2-1/2"	7/8"	7/8"	1-1/32"	6	✓	•
11/16"	F5122HL	II	2-1/2"	15/16"	15/16"	1-1/32"	6	✓	•
3/4"	F5124HL	II	2-1/2"	1-1/32"	1-1/32"	1-1/32"	6	✓	•
13/16"	F5126HL	II	2-1/2"	1-3/32"	1-3/32"	1-1/32"	6	✓	•
7/8"	F5128HL	II	2-1/2"	1-1/8"	1-1/8"	1-1/32"	6	✓	•

		6
ITEM		S12S
PIECES		9
PACKING		
AVAILABLE		✓

## 3/8" DRIVE SOCKETS

### 3/8" DRIVE METRIC DEEP SOCKETS 12 AND 6 POINT



DEEP SOCKET

METRIC

3/8"

12

6



TYPE I



TYPE II

- Made of high quality micro alloyed steel.
- Super drive® design.
- Nickel - Chrome plated.
- Exceed FEDERAL GGG-W-641E, ASME B107.1, ISO 3315, SAE AS 4283, DIN 3124 standards.

#### INDIVIDUAL SOCKETS

OPENING SIZE	ITEM	TYPE	LENGTH	NUT END OUTSIDE DIAMETER	DRIVE END OUTSIDE DIAMETER	NUT DEPTH	AVAILABLE
6 mm	5006HM	I	2-1/2"	3/8"	11/16"	3/8"	✓
7 mm	5007HM	I	2-1/2"	7/16"	11/16"	9/16"	✓
8 mm	5008M 5008HM	I	2-1/2"	7/16"	21/32"	13/16"	✓
9 mm	5009M 5009HM	I	2-1/2"	1/2"	11/16"	13/16"	✓
10 mm	5010M 5010HM	I	2-1/2"	9/16"	11/16"	13/16"	✓
11 mm	5011M 5011HM	I	2-1/2"	5/8"	11/16"	13/16"	✓
12 mm	5012M 5012HM	II	2-1/2"	11/16"	11/16"	13/16"	✓
13 mm	5013M 5013HM	II	2-1/2"	3/4"	3/4"	13/16"	✓
14 mm	5014M 5014HM	II	2-1/2"	3/4"	3/4"	13/16"	✓
15 mm	5015M 5015HM	II	2-1/2"	3/4"	3/4"	13/16"	✓
16 mm	5016M 5016HM	II	2-1/2"	3/4"	3/4"	13/16"	✓
17 mm	5017M 5017HM	II	2-1/2"	15/16"	15/16"	13/16"	✓
18 mm	5018M 5018HM	II	2-1/2"	15/16"	15/16"	13/16"	✓
19 mm	5019M 5019HM	II	2-1/2"	1"	1"	13/16"	✓
20 mm	5020HM	II	2-1/2"	1"	1"	13/16"	✓
21 mm	5021HM	II	2-1/2"	1-1/8"	1-1/8"	13/16"	✓
22 mm	5022HM	II	2-1/2"	1-5/32"	1-5/32"	13/16"	✓
23 mm	5023HM	II	2-1/2"	1-1/8"	1-1/8"	13/16"	✓

#### SOCKETS SETS

ITEM	52209	52203	52205
PIECES	11	18	12
PACKING			
AVAILABLE	✓	✓	✓

### 3/8" DRIVE METRIC DEEP SOCKETS 6 POINT



DEEP SOCKET

METRIC

3/8"

6



TYPE I



TYPE II

- Made of Chrome vanadium steel.
- Super drive® design.
- ASME B107.110 standards.

#### INDIVIDUAL SOCKETS

OPENING SIZE	ITEM	TYPE	LENGTH	NUT END OUTSIDE DIAMETER	DRIVE END OUTSIDE DIAMETER	NUT DEPTH	AVAILABLE
10 mm	F5110HLM	I	2-1/2"	9/16"	5/8"	1-1/32"	✓
11 mm	F5111HLM	I	2-1/2"	5/8"	5/8"	1-1/32"	✓
12 mm	F5112HLM	II	2-1/2"	9/16"	5/8"	1-1/32"	✓
13 mm	F5113HLM	II	2-1/2"	11/16"	11/16"	1-1/32"	✓
14 mm	F5114HLM	II	2-1/2"	3/4"	3/4"	1-1/32"	✓
15 mm	F5115HLM	II	2-1/2"	13/16"	13/16"	1-1/32"	✓
16 mm	F5116HLM	II	2-1/2"	7/8"	7/8"	1-1/32"	✓
17 mm	F5117HLM	II	2-1/2"	15/16"	15/16"	1-1/32"	✓
18 mm	F5118HLM	II	2-1/2"	31/32"	31/32"	1-1/32"	✓
19 mm	F5119HLM	II	2-1/2"	1-1/32"	1-1/32"	1-1/32"	✓

#### SOCKET SET

ITEM	S12M
PIECES	9
PACKING	
AVAILABLE	✓

# 03 HAND SOCKETS AND ACCESSORIES

## 3/8" DRIVE SOCKETS

### 3/8" DRIVE SAE SOCKETS 8 POINT



URREA  
SUPERIOR QUALITY AFFORDABLE TOOLS



TYPE I

TYPE II

- Ideal for use with square bolts and nuts.
- This design provides greater contact and does not cause damage when used with soft materials.

#### INDIVIDUAL SOCKETS

OPENING SIZE	ITEM	TYPE	LENGTH	NUT END OUTSIDE DIAMETER	DRIVE END OUTSIDE DIAMETER	NUT DEPTH	⊞	AVAILABLE
5/16"	5210S	I	1-1/8"	19/32"	21/32"	1/8"	6	✓
1/2"	5216S	II	1-1/8"	27/32"	27/32"	1/4"	6	✓

### 3/8" DRIVE SAE FLEXIBLE SOCKETS 6 POINT



URREA  
SUPERIOR QUALITY AFFORDABLE TOOLS



5276H

- Made of high quality micro alloyed steel.
- Super drive® design.
- Nickel - Chrome plated.
- Ideal for removing screws in hard-to-reach places.
- Die bending angle greater than 65°.
- ASME B107.1, AS 954E, S3.8.1. standards.

#### INDIVIDUAL SOCKETS

OPENING SIZE	ITEM	LENGTH	NUT END OUTSIDE DIAMETER	DRIVE END OUTSIDE DIAMETER	NUT DEPTH	⊞	AVAILABLE
3/8"	5273H	1-3/4"	9/16"	3/4"	1/4"	1	On Request
9/16"	5276H	1-7/8"	25/32"	3/4"	3/8"	1	✓
11/16"	5278H	1-7/8"	15/16"	3/4"	7/16"	1	✓

### 3/8" DRIVE METRIC FLEXIBLE SOCKETS 6 POINT



URREA  
SUPERIOR QUALITY AFFORDABLE TOOLS



5278MH

- Made of high quality micro alloyed steel.
- Super drive® design.
- Nickel - Chrome plated.
- Ideal for removing screws in hard-to-reach places.
- Die bending angle greater than 65°.
- ASME B107.1, AS 954E, S3.8.1. standards.

#### INDIVIDUAL SOCKETS

OPENING SIZE	ITEM	LENGTH	NUT END OUTSIDE DIAMETER	DRIVE END OUTSIDE DIAMETER	NUT DEPTH	⊞	AVAILABLE
11 mm	5274MH	1-25/32"	41/64"	3/4"	5/16"	1	✓
15 mm	5278MH	1-31/32"	7/8"	3/4"	3/8"	1	✓
16 mm	5279MH	1-31/32"	7/8"	3/4"	3/8"	1	On Request
17 mm	5280MH	1-31/32"	61/64"	3/4"	3/8"	1	✓
19 mm	5282MH	1-31/32"	1"	3/4"	1/2"	1	✓

### 3/8" DRIVE TORX AND FEMALE TORX SOCKET SET



URREA  
SUPERIOR QUALITY AFFORDABLE TOOLS



14  
PIECES

Content	
Sockets	Bits
E10	T20
E11	T25
E12	T27
E14	T30
E16	T40
E18	T45
E20	
Adapter	



ITEM	PIECES	⊞	AVAILABLE
52ET14	14	1	✓

**URREA**  
SUPERIOR QUALITY AFFORDABLE TOOLS

SUPERIOR TORQUE  
Transfer

usa.urrea.com

3/8" DRIVE SAE SOCKETS 8 POINT

HAND SOCKETS AND ACCESSORIES

## 3/8" DRIVE SOCKETS

### 3/8" DRIVE TORX FEMALE SOCKET SET



TYPE I

TYPE II

- Made of Chrome vanadium steel.
- Nickel - Chrome plated.
- Heat treated to offer high performance and protect them from corrosion.

INDIVIDUAL SOCKETS										SOCKET SET	
OPENING SIZE	ITEM	TYPE	LENGTH	NUT END OUTSIDE DIAMETER	DRIVE END OUTSIDE DIAMETER	NUT DEPTH	AVAILABLE	ITEM	PIECES	PACKING	AVAILABLE
E4	5204TX	I	1-1/8"	5/16"	11/16"	3/16"	6	5200TX	10	1	✓
E5	5205TX	I	1-1/8"	5/16"	11/16"	3/16"	6				•
E6	5206TX	I	1-1/8"	3/8"	11/16"	1/4"	6				•
E7	5207TX	I	1-1/8"	3/8"	11/16"	1/4"	6				•
E8	5208TX	I	1-1/8"	7/16"	11/16"	1/4"	6				•
E10	5210TX	I	1-1/8"	1/2"	11/16"	5/16"	6				•
E11	5211TX	I	1-1/8"	1/2"	11/16"	5/16"	6				•
E12	5212TX	I	1-1/8"	9/16"	11/16"	5/16"	6				•
E14	5214TX	II	1-1/8"	23/32"	23/32"	3/8"	6				•
E18	5218TX	II	1-1/8"	7/8"	7/8"	7/16"	6				•

### 3/8" DRIVE TORX TAMPER PROOF SOCKET SET 5 POINT



<b>13</b> PIECES	Contenido
	T8 T9
	T10 T15
	T20 T25
	T27 T30
	T40 T45
	T50 T55
	T60



- They are mainly used in electrical sensors and parts inside the vehicle.
- Designed for special hardware found in German vehicles of the brands MERCEDES BENZ®, BMW®, PORSCHE® and some CHRYSLER® brand vehicles.

ITEM	PIECES	AVAILABLE
5239S	13	✓



### 3/8" DRIVE TORX BIT SOCKETS



523910W

- Made of Chrome vanadium steel.
- Nickel - Chrome plated.
- Heat treated to offer high performance and protect them from corrosion.
- Ideal for application in the automotive industry.

INDIVIDUAL SOCKETS							SOCKETS SET	
TIP SIZE	ITEM	TOTAL LENGTH	TOTAL BIT LENGTH	BIT LENGTH EXPOSED	DRIVE END OUTSIDE DIAMETER	AVAILABLE	ITEM	PIECES
T10	523910W	2-3/8"	1-5/16"	7/8"	11/16"	6	5239C	9
T15	523915W	2-3/8"	1-5/16"	7/8"	11/16"	6		
T20	523920W	2-3/8"	1-5/16"	7/8"	11/16"	6		
T25	523925W	2-3/8"	1-5/16"	7/8"	11/16"	6		
T27	523927W	2-3/8"	1-5/16"	7/8"	11/16"	6		
T30	523930W	2-3/8"	1-5/16"	7/8"	11/16"	6		
T40	523940W	2-3/8"	1-5/16"	7/8"	11/16"	6		
T45	523945W	2-3/8"	1-5/16"	7/8"	11/16"	6		
T50	523950W	2-3/8"	1-5/16"	7/8"	11/16"	6		

### SPARE PARTS FOR TORX BIT



R5239T10

ITEM	SIZE	FOR ITEM	TOTAL BIT LENGTH	AVAILABLE
R5239T10	T10	523910W	1-5/16"	✓
R5239T15	T15	523915W	1-5/16"	✓
R5239T20	T20	523920W	1-5/16"	✓
R5239T25	T25	523925W	1-5/16"	✓
R5239T27	T27	523927W	1-5/16"	✓
R5239T30	T30	523930W	1-5/16"	✓
R5239T40	T40	523940W	1-5/16"	On Request
R5239T45	T45	523945W	1-5/16"	On Request
R5239T50	T50	523950W	1-5/16"	✓

## 3/8" DRIVE SOCKETS



DEEP SOCKET

TORX®



SURTEK  
TOOLS FOR SPECIALISTS



HAND SOCKETS AND ACCESSORIES



BF51T40

- Made of high quality micro alloyed steel.
- Heat treated to offer high performance and protect them from corrosion.

INDIVIDUAL SOCKETS							SOCKETS SET	
TP SIZE	ITEM	TOTAL LENGTH	TOTAL BIT LENGTH	BIT LENGTH EXPOSED	DRIVE END OUTSIDE DIAMETER	AVAILABLE	On Request	
T15	-					Not AVAILABLE for individual sale	•	
T20	BF51T20	2"	1-1/2"	1-5/16"	3/8"	6	On Request	
T27	BF51T27	2"	1-1/2"	1-5/16"	3/8"	6	On Request	
T30	BF51T30	2"	1-1/2"	1-5/16"	3/8"	6	On Request	
T40	BF51T40	2"	1-1/2"	1-5/16"	3/8"	6	On Request	
T45	BF51T45	2"	1-1/2"	1-5/16"	3/8"	6	On Request	
T47	BF51T47	2"	1-1/2"	1-5/16"	3/8"	6	On Request	
T50	BF51T50	2"	1-1/2"	1-5/16"	3/8"	6	On Request	
T55	BF51T55	2"	1-1/2"	1-5/16"	3/8"	6	On Request	
T60	BF51T60	2"	1-1/2"	1-5/16"	3/8"	6	On Request	

## 3/8" DRIVE SAE HEXAGONAL BIT SOCKETS 6 POINT



SHORT BIT

HEXAGONAL

INCHES



URREA  
SUPERIOR QUALITY AFFORDABLE TOOLS



4990-1/8

4990-1/4

- Made of Chrome vanadium steel.
- Nickel - Chrome plated.
- Heat treated to offer high performance and protect them from corrosion.
- Ideal for application in the automotive industry.

INDIVIDUAL SOCKETS							SOCKETS SET	
OPENING SIZE	ITEM	TOTAL LENGTH	TOTAL BIT LENGTH	BIT LENGTH EXPOSED	DRIVE END OUTSIDE DIAMETER	AVAILABLE	✓	
1/8"	4990-1/8	2-3/8"	1-5/16"	7/8"	11/16"	6	✓	
5/32"	4990-5/32	2-3/8"	1-5/16"	7/8"	11/16"	6	✓	
3/16"	4990-3/16	2-3/8"	1-5/16"	7/8"	11/16"	6	✓	
7/32"	4990-7/32	2-3/8"	1-5/16"	7/8"	11/16"	6	✓	
1/4"	4990-1/4	2-3/8"	1-5/16"	7/8"	11/16"	6	✓	
5/16"	4990-5/16	2-3/8"	1-5/16"	7/8"	11/16"	6	✓	
3/8"	4990-3/8	2-3/8"	1-5/16"	7/8"	11/16"	6	✓	

## 3/8" DRIVE SAE HEXAGONAL BIT SOCKETS



SHORT BIT

HEXAGONAL

INCHES



SURTEK  
TOOLS FOR SPECIALISTS



F51H06

- Made of high quality micro alloyed steel.
- Heat treated to offer high performance and protect them from corrosion.

INDIVIDUAL SOCKETS							SOCKETS SET	
TP SIZE	ITEM	TOTAL LENGTH	TOTAL BIT LENGTH	BIT LENGTH EXPOSED	DRIVE END OUTSIDE DIAMETER	AVAILABLE	On Request	
1/8"	-					Not AVAILABLE for individual sale	•	
5/32"	-					Not AVAILABLE for individual sale	•	
3/16"	F51H06	3/8"	3-1/16"	1-57/64"	3/8"	1	On Request	
7/32"	F51H07	3/8"	3-1/16"	1-57/64"	3/8"	1	On Request	
1/4"	F51H08	3/8"	3-1/16"	1-57/64"	3/8"	1	On Request	
5/16"	F51H10	3/8"	3-1/16"	1-57/64"	3/8"	1	On Request	
3/8"	F51H12	3/8"	3-1/16"	1-57/64"	3/8"	1	On Request	

## 3/8" DRIVE SOCKETS

### 3/8" DRIVE METRIC HEXAGONAL BIT SOCKETS



SHORT BIT

HEXAGONAL

METRIC



URREA



49906M

499010M

- Made of Chrome vanadium steel.
- Nickel - Chrome plated.
- Heat treated to offer high performance and protect them from corrosion.
- Ideal for application in the automotive industry.



INDIVIDUAL SOCKETS



TIP SIZE	ITEM	TOTAL LENGTH	TOTAL BIT LENGTH	BIT LENGTH EXPOSED	DRIVE END OUTSIDE DIAMETER	PACKING	AVAILABLE	SOCKETS SET
4 mm	<b>49904M</b>	2-3/8"	1-5/16"	27/32"	11/16"	6	✓	<b>4990M6</b>
5 mm	<b>49905M</b>	2-3/8"	1-5/16"	27/32"	11/16"	6	✓	<b>6</b>
6 mm	<b>49906M</b>	2-3/8"	1-5/16"	27/32"	11/16"	6	✓	<b>PACKING</b>
7 mm	<b>49907M</b>	2-3/8"	1-5/16"	27/32"	11/16"	6	✓	<b>1</b>
8 mm	<b>49908M</b>	2-3/8"	1-5/16"	27/32"	11/16"	6	✓	<b>1</b>
10 mm	<b>499010M</b>	2-3/8"	1-5/16"	27/32"	11/16"	6	✓	<b>1</b>

### 3/8" DRIVE METRIC HEXAGONAL BIT SOCKETS



SHORT BIT

HEXAGONAL

METRIC



SURTEK



F51H04M

- Made of Chrome vanadium.
- Heat treated to offer high performance and protect them from corrosion.



INDIVIDUAL SOCKETS



TIP SIZE	ITEM	TOTAL LENGTH	TOTAL BIT LENGTH	BIT LENGTH EXPOSED	DRIVE END OUTSIDE DIAMETER	PACKING	AVAILABLE	SOCKETS SET
3 mm	-						Not AVAILABLE for individual sale	<b>F51H00M</b>
4 mm	<b>F51H04M</b>	1-7/8"	1-1/2"	1-3/16"	3/8"	1	✓	<b>7</b>
5 mm	<b>F51H05M</b>	1-7/8"	1-1/2"	1-3/16"	3/8"	1	✓	<b>PACKING</b>
6 mm	<b>F51H06M</b>	1-7/8"	1-1/2"	1-3/16"	3/8"	1	✓	<b>1</b>
7 mm	<b>F51H07M</b>	1-7/8"	1-1/2"	1-3/16"	3/8"	1	On Request	<b>1</b>
8 mm	<b>F51H08M</b>	1-7/8"	1-1/2"	1-3/16"	3/8"	1	✓	<b>1</b>
10 mm	<b>F51H10M</b>	1-7/8"	1-1/2"	1-3/16"	3/8"	1	✓	<b>1</b>

### 3/8" DRIVE SAE HEXAGONAL EXTRA-LONG BIT SOCKETS



EXTRA LONG BIT

HEXAGONAL

INCHES



URREA



4990-1/8L

4990-1/4L

- Made of Chrome vanadium steel.
- Nickel - Chrome plated.
- Heat treated to offer high performance and protect them from corrosion.
- Ideal for application in the automotive industry.



INDIVIDUAL SOCKETS



TIP SIZE	ITEM	TYPE	TOTAL LENGTH	TOTAL BIT LENGTH	BIT LENGTH EXPOSED	DRIVE END OUTSIDE DIAMETER	PACKING	AVAILABLE	SOCKETS SET
1/8"	<b>4990-1/8L</b>	I	6"	5-3/8"	4-7/8"	11/16"	6	✓	<b>4990-7L</b>
5/32"	<b>4990-5/32L</b>	I	6"	5-3/8"	4-7/8"	11/16"	6	✓	<b>7</b>
3/16"	<b>4990-3/16L</b>	I	6"	5-3/8"	4-7/8"	11/16"	6	✓	<b>PACKING</b>
7/32"	<b>4990-7/32L</b>	I	6"	5-3/8"	4-7/8"	11/16"	6	✓	<b>1</b>
1/4"	<b>4990-1/4L</b>	I	6"	5-3/8"	4-7/8"	11/16"	6	✓	<b>1</b>
5/16"	<b>4990-5/16L</b>	II	6"	5-3/8"	4-7/8"	11/16"	6	✓	<b>1</b>
3/8"	<b>4990-3/8L</b>	II	6"	5-3/8"	4-7/8"	11/16"	6	✓	<b>1</b>

## 3/8" DRIVE SOCKETS

### 3/8" DRIVE METRIC HEXAGONAL EXTRA-LONG SOCKET SET



HAND SOCKETS AND ACCESSORIES



- Made of Chrome vanadium steel.
- Nickel - Chrome plated.
- Heat treated to offer high performance and protect them from corrosion.
- Ideal for application in the automotive industry.

INDIVIDUAL SOCKETS								SOCKETS SET	
TIP SIZE	ITEM	TYPE	TOTAL LENGTH	TOTAL BIT LENGTH	BIT LENGTH EXPOSED	DRIVE END OUTSIDE DIAMETER	PACKING	AVAILABLE	✓
4 mm	49904ML	I	6"	5-3/8"	5"	11/16"	6	✓	•
5 mm	49905ML	I	6"	5-3/8"	5"	11/16"	6	✓	•
6 mm	49906ML	I	6"	5-3/8"	5"	11/16"	6	✓	•
7 mm	49907ML	II	6"	5-3/8"	5"	11/16"	6	✓	•
8 mm	49908ML	II	6"	5-3/8"	5"	11/16"	6	✓	•
10 mm	499010ML	II	6"	5-3/8"	5"	11/16"	6	✓	•

### 3/8" DRIVE SAE HEXAGONAL BIT BALL SOCKET SET 6 POINT



Item	Size
4990-3/8BD	3/8"
4990-5/16BD	5/16"
4990-1/4BD	1/4"
4990-7/32BD	7/32"
4990-3/16BD	3/16"
4990-5/32BD	5/32"



- Ergonomic design allows natural rotation of hand and wrist. Quick funnel-type inlet with secure coupling.

ITEM	PIECES	PACKING	AVAILABLE
4990BD	6	1	✓

### 3/8" DRIVE METRIC HEXAGONAL BIT BALL SOCKET SET



Item	Size
49903BDM	3 mm
49904BDM	4 mm
49905BDM	5 mm
49906BDM	6 mm
49907BDM	7 mm
49908BDM	8 mm
49909BDM	9 mm
499010BDM	10 mm



- Ergonomic design allows natural rotation of hand and wrist. Quick funnel-type inlet with secure coupling.

ITEM	PIECES	PACKING	AVAILABLE
4990BDM	8	1	✓

### 3/8" DRIVE RIBE BIT SOCKETS



- Made of Chrome vanadium steel.
- Nickel - Chrome plated.
- Heat treated to offer high performance and protect them from corrosion.

INDIVIDUAL SOCKETS								SOCKETS SET	
RIBE SIZE	ITEM	TYPE	TOTAL LENGTH	TOTAL BIT LENGTH	BIT LENGTH EXPOSED	DRIVE END OUTSIDE DIAMETER	PACKING	AVAILABLE	✓
M5	4991-5M	I	4"	3-1/4"	2-7/8"	11/16"	6	✓	•
M6	4991-6M	I	4"	3-1/4"	2-7/8"	11/16"	6	✓	•
M7	4991-7M	I	4"	3-1/4"	2-7/8"	11/16"	6	✓	•
M8	4991-8M	I	4"	3-1/4"	2-7/8"	11/16"	6	✓	•
M10	4991-10M	II	4"	3-1/4"	2-7/8"	11/16"	6	✓	•



## 3/8" DRIVE SOCKETS

### 3/8" DRIVE SAE CROWFOOT WRENCHES



INCHES

3/8"



URREA



4916



4932

#### CROWFOOT WRENCH SET



ITEM 4900-10  
PIECES 10



PACKING 1  
AVAILABLE ✓

• Ideal for small spaces where the open end of a conventional wrench cannot reach.



#### INDIVIDUAL CROWFOOT WRENCHES



BULK

OPENING SIZE	ITEM	TOTAL LENGTH	HEAD WIDTH	OUTSIDE DRIVE	DRIVE END WIDTH	BULK	AVAILABLE
3/8"	4912	1-1/16"	13/16"	5/8"	7/32"	6	✓
7/16"	4914	1-3/16"	1-1/16"	3/4"	7/32"	6	✓
1/2"	4916	1-1/2"	1-1/16"	3/4"	1/4"	6	✓
9/16"	4918	1-5/8"	1-7/32"	3/4"	9/32"	6	✓
5/8"	4920	1-5/8"	1-11/32"	3/4"	9/32"	6	✓
11/16"	4922	1-3/4"	1-7/16"	13/16"	9/64"	6	✓
3/4"	4924	1-7/8"	1-5/8"	13/16"	11/32"	6	✓
13/16"	4926	1-15/16"	1-11/16"	13/16"	11/32"	6	✓
7/8"	4928	2-1/16"	1-7/8"	13/16"	3/8"	6	✓
1"	4932	2-5/32"	2"	13/16"	13/32"	6	✓

### 3/8" DRIVE METRIC CROWFOOT WRENCHES



METRIC

3/8"



URREA



4912M



4922M

#### CROWFOOT WRENCH SET



ITEM 4900-12M  
PIECES 12



PACKING 1  
AVAILABLE ✓

• Ideal for small spaces where the open end of a conventional wrench cannot reach.



#### INDIVIDUAL CROWFOOT WRENCHES



BULK

OPENING SIZE	ITEM	TOTAL LENGTH	HEAD WIDTH	OUTSIDE DRIVE	DRIVE END WIDTH	BULK	AVAILABLE
10 mm	4910M	1-1/16"	13/16"	5/8"	7/32"	6	✓
11 mm	4911M	1-1/8"	15/16"	11/16"	7/32"	6	✓
12 mm	4912M	1-1/2"	1-1/16"	11/16"	7/32"	6	✓
13 mm	4913M	1-1/2"	1-1/16"	11/16"	7/32"	6	✓
14 mm	4914M	1-9/16"	1-3/16"	11/16"	7/32"	6	✓
15 mm	4915M	1-19/32"	1-3/16"	11/16"	9/32"	6	✓
16 mm	4916M	1-5/8"	1-5/16"	3/4"	9/32"	6	✓
17 mm	4917M	1-23/32"	1-7/16"	3/4"	9/32"	6	✓
18 mm	4918M	1-7/8"	1-9/16"	3/4"	9/32"	6	✓
19 mm	4919M	1-7/8"	1-19/32"	3/4"	5/16"	6	✓
21 mm	4921M	1-31/32"	1-11/16"	3/4"	11/32"	6	✓
22 mm	4922M	1-11/16"	2"	3/4"	11/32"	6	✓

## 1/2" DRIVE SOCKETS

### 1/2" DRIVE SAE SOCKETS 12 AND 6 POINT



HAND SOCKETS AND ACCESSORIES



TYPE I



TYPE II



TYPE III

- Made of high quality micro alloyed steel.
- Super drive® design.
- Nickel - Chrome plated.
- Exceed FEDERAL GGG-W-641, ASME /ANSI B10, ISO 3315, SAE AS 4283, DIN 3123 standards.



OPENING SIZE	INDIVIDUAL SOCKETS		LENGTH	NUT END OUTSIDE DIAMETER	DRIVE END OUTSIDE DIAMETER	NUT DEPTH	PACKING	SOCKETS SETS										
	ITEM	TYPE						12	12	12	12	12	6	6	6			
1/4"	5408 5408H	I	1-1/2"	9/16"	7/8"	9/16"	6	1	✓	•								
5/16"	5410 5410H	I	1-1/2"	9/16"	7/8"	9/16"	6	1	✓	•								
3/8"	5412 5412H	I	1-1/2"	9/16"	7/8"	9/16"	6	1	✓	•	•	•						
7/16"	5414 5414H	I	1-1/2"	11/16"	7/8"	9/16"	6	1	✓	•	•	•	•					
1/2"	5416 5416H	I	1-1/2"	3/4"	7/8"	7/16"	6	1	✓	•	•	•	•	•	•	•	•	•
17/32"	5417 —	I	1-1/2"	13/16"	7/8"	1/2"	6	1	✓	•								
9/16"	5418 5418H	I	1-1/2"	13/16"	7/8"	1/2"	6	1	✓	•	•	•						
19/32"	5419 5419H	II	1-1/2"	11/16"	7/8"	9/16"	6	1	✓	•								
5/8"	5420 5420H	II	1-1/2"	15/16"	15/16"	1/2"	6	1	✓	•	•	•	•	•	•	•	•	•
11/16"	5422 5422H	II	1-1/2"	15/16"	15/16"	1/2"	6	1	✓	•	•	•	•	•	•	•	•	•
3/4"	5424 5424H	II	1-1/2"	1"	1"	9/16"	6	1	✓	•	•	•	•	•	•	•	•	•
25/32"	5425 5425H	II	1-1/2"	1-1/8"	1-1/8"	5/8"	6	1	✓	•								
13/16"	5426 5426H	II	1-1/2"	1-1/8"	1-3/16"	5/8"	6	1	✓	•	•	•	•	•	•	•	•	•
7/8"	5428 5428H	II	1-1/2"	1-3/16"	1-3/16"	5/8"	6	1	✓	•	•	•	•	•	•	•	•	•
29/32"	5429 —	II	1-7/8"	1-1/4"	1-3/16"	5/8"	6	1	✓	•								
15/16"	5430 5430H	II	1-5/8"	1-1/4"	1-1/4"	11/16"	6	1	✓	•	•	•	•	•	•	•	•	•
31/32"	5431 —	II	1-3/4"	1-1/4"	1-3/8"	3/4"	6	1	✓	•								
1"	5432 5432H	II	1-3/4"	1-5/16"	1-3/8"	3/4"	6	1	✓	•	•	•	•	•	•	•	•	•
1-1/16"	5434 5434H	II	1-13/16"	1-7/16"	1-1/2"	13/16"	1	1	✓	•	•	•	•	•	•	•	•	•
1-1/8"	5436 5436H	II	1-13/16"	1-1/2"	1-5/8"	7/8"	1	1	✓	•	•	•	•	•	•	•	•	•
1-3/16"	5438 5438H	II	1-15/16"	1-9/16"	1-5/8"	1"	1	1	✓	•	•	•	•	•	•	•	•	•
1-1/4"	5440 5440H	II	1-15/16"	1-5/8"	1-5/8"	1"	1	1	✓	•	•	•	•	•	•	•	•	•
1-5/16"	5442 5442H	III	2-13/32"	1-3/4"	1-5/8"	1-5/16"	1	1	✓									
1-3/8"	5444 5444H	III	2-13/32"	1-13/16"	1-5/8"	1-5/16"	1	1	✓									
1-7/16"	5446 5446H	III	2-1/2"	1-7/8"	1-5/8"	1-7/16"	1	1	✓									
1-1/2"	5448 5448H	III	2-1/2"	1-5/8"	1-5/8"	1-7/16"	1	1	✓									



**SUPERIOR Reliability**



usa.urrea.com

1/2" DRIVE SAE SOCKETS 12 AND 6 POINT

## 1/2" DRIVE SOCKETS

### 1/2" DRIVE SAE SOCKETS 12 POINT



SHORT SOCKET

INCHES



SURTEK



NEW



TYPE I



TYPE II

- Made of Chrome vanadium steel.
- Super drive® design.
- Exceed ASME B107.110 standards.

#### INDIVIDUAL SOCKETS



OPENING SIZE	ITEM	TYPE	LENGTH	NUT END OUTSIDE DIAMETER	DRIVE END OUTSIDE DIAMETER	NUT DEPTH	AVAILABLE	SOCKETS SETS
5/16"	F5810	I	1-1/2"	1/2"	7/8"	1/4"	6	12 F5800A 14
3/8"	F5812	I	1-1/2"	9/16"	7/8"	1/4"	6	12 S01S 8
7/16"	F5814	I	1-1/2"	11/16"	7/8"	11/32"	6	
1/2"	F5816	I	1-1/2"	3/4"	7/8"	11/32"	6	
17/32"	F5817	I	1-1/2"	13/16"	7/8"	11/32"	6	
9/16"	F5818	I	1-1/2"	13/16"	7/8"	11/32"	6	
19/32"	F5819	II	1-1/2"	7/8"	7/8"	7/16"	6	
5/8"	F5820	II	1-1/2"	15/16"	15/16"	15/32"	6	
11/16"	F5822	II	1-1/2"	1"	1"	1/2"	6	
3/4"	F5824	II	1-1/2"	1-1/16"	1-1/16"	19/32"	6	
25/32"	F5825	II	1-1/2"	1-1/8"	1-1/8"	5/8"	6	
13/16"	F5826	II	1-1/2"	1-1/8"	1-1/8"	21/32"	6	
7/8"	F5828	II	1-1/2"	1-3/16"	1-3/16"	13/16"	6	
15/16"	F5830	II	1-1/2"	1-1/4"	1-1/4"	13/16"	6	
1"	F5832	II	1-9/16"	1-3/8"	1-3/8"	19/32"	6	
1-1/16"	F5834	II	1-5/8"	1-7/16"	1-7/16"	21/32"	6	
1-1/8"	F5836	II	1-3/4"	1-1/2"	1-1/2"	25/32"	6	On Request
1-3/16"	F5838	II	1-3/4"	1-5/8"	1-5/8"	25/32"	6	
1-1/4"	F5840	II	1-13/16"	1-5/8"	1-5/8"	13/16"	6	

PROFESSIONAL FORCE

SURTEK TOOLS FOR SPECIALISTS



usa.urrea.com

1/2" DRIVE SAE SOCKETS 12 POINT

## 1/2" DRIVE SOCKETS

### 1/2" DRIVE METRIC 12 AND 6-POINT SOCKETS



HAND SOCKETS AND ACCESSORIES



TYPE I



TYPE II



TYPE III

- Made of high quality micro alloyed steel.
- Super drive® design.
- Nickel - Chrome plated.
- Exceed FEDERAL GGG-W-641E, ASME B107.1, ISO 3315, SAE AS 4283, DIN 3124 standards.

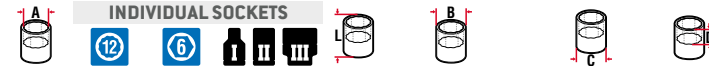

OPENING SIZE	ITEM	TYPE	LENGTH	NUT END OUTSIDE DIAMETER	DRIVE END OUTSIDE DIAMETER	NUT DEPTH	AVAILABLE
8 mm	5408M 5408HM	I	1-1/2"	1/2"	27/32"	15/32"	✓
9 mm	5409M 5409HM	I	1-1/2"	17/32"	27/32"	15/32"	✓
10 mm	5410M 5410HM	I	1-1/2"	9/16"	13/16"	1/4"	✓
11 mm	5411M 5411HM	I	1-1/2"	21/32"	13/16"	11/32"	✓
12 mm	5412M 5412HM	I	1-1/2"	23/32"	13/16"	11/32"	✓
13 mm	5413M 5413HM	I	1-1/2"	3/4"	13/16"	11/32"	✓
14 mm	5414M 5414HM	I	1-1/2"	13/16"	13/16"	11/32"	✓
15 mm	5415M 5415HM	II	1-1/2"	7/8"	7/8"	7/16"	✓
16 mm	5416M 5416HM	II	1-1/2"	15/16"	15/16"	15/32"	✓
17 mm	5417M 5417HM	II	1-1/2"	1"	1"	1/2"	✓
18 mm	5418M 5418HM	II	1-1/2"	1-1/16"	1-1/16"	9/16"	✓
19 mm	5419M 5419HM	II	1-1/2"	1-1/16"	1-1/16"	19/32"	✓
20 mm	5420M 5420HM	II	1-1/2"	1-1/8"	1-1/8"	5/8"	✓
21 mm	5421M 5421HM	II	1-1/2"	1-1/8"	1-1/8"	21/32"	✓
22 mm	5422M 5422HM	II	1-1/2"	1-1/4"	1-1/4"	29/32"	✓
23 mm	5423M 5423HM	II	1-1/2"	1-1/4"	1-1/4"	15/16"	✓
24 mm	5424M 5424HM	II	1-1/2"	1-1/4"	1-1/4"	31/32"	✓
25 mm	5425M 5425HM	II	1-9/16"	1-3/8"	1-3/8"	25/32"	✓
26 mm	5426M 5426HM	II	1-9/16"	1-3/8"	1-3/8"	25/32"	✓
27 mm	5427M 5427HM	II	1-5/8"	1-7/16"	1-7/16"	3/4"	✓
28 mm	5428M 5428HM	II	1-3/4"	1-1/2"	1-1/2"	3/4"	✓
29 mm	5429M 5429HM	II	1-3/4"	1-1/2"	1-1/2"	25/32"	✓
30 mm	5430M 5430HM	II	1-3/4"	1-5/8"	1-5/8"	25/32"	✓
31 mm	5431M —	II	1-13/16"	1-5/8"	1-5/8"	13/16"	✓
32 mm	5432M 5432HM	II	1-13/16"	1-5/8"	1-5/8"	13/16"	✓
34 mm	5434M 5434HM	III	2"	1-15/16"	1-1/2"	1"	✓
36 mm	5436M 5436HM	III	2"	1-15/16"	1-1/2"	1"	✓

		12	12	12	12	12	6	6	6
ITEM		54211	54214	54206	5400PAM	54212	54209	54205	54213
PIECES		24	15	15	14	12	24	15	12
PACKING									
AVAILABLE		✓	✓	✓	✓	✓	✓	✓	✓

usa.urrea.com

# SUPERIOR Handling

1/2" DRIVE METRIC 12 and 6-POINT SOCKETS

## 1/2" DRIVE SOCKETS

### 1/2" DRIVE METRIC SOCKETS 12 POINT



SHORT SOCKET

METRIC



**SURTEK**  
TOOLS FOR SPECIALISTS



TYPE I



TYPE II

- Made of Chrome vanadium steel.
- Super drive® design.
- Exceed ASME B107.110 standard.

#### INDIVIDUAL SOCKETS



OPENING SIZE	ITEM	TYPE	LENGTH	NUT END OUTSIDE DIAMETER	DRIVE END OUTSIDE DIAMETER	NUT DEPTH	⊘	AVAILABLE	12	12
9 mm	F5809M	I	1-1/2"	9/16"	27/32"	15/32"	6	✓		
10 mm	F5810M	I	1-1/2"	19/32"	27/32"	15/32"	6	✓	•	•
11 mm	F5811M	I	1-1/2"	5/8"	27/32"	15/32"	6	✓		•
12 mm	F5812M	I	1-1/2"	11/16"	27/32"	15/32"	6	✓		•
13 mm	F5813M	I	1-1/2"	23/32"	15/16"	15/32"	6	On Request	•	•
14 mm	F5814M	I	1-1/2"	25/32"	15/16"	15/32"	6	✓	•	•
15 mm	F5815M	II	1-1/2"	15/16"	15/16"	15/32"	6	On Request	•	•
16 mm	F5816M	II	1-1/2"	15/16"	15/16"	15/32"	6	✓	•	
17 mm	F5817M	II	1-1/2"	15/16"	15/16"	1/2"	6	On Request		•
18 mm	F5818M	II	1-1/2"	31/32"	31/32"	1/2"	6	✓		
19 mm	F5819M	II	1-1/2"	1"	1"	1/2"	6	✓	•	•
20 mm	F5820M	II	1-1/2"	1-3/32"	1-3/32"	1/2"	6	✓		
21 mm	F5821M	II	1-1/2"	1-1/8"	1-1/8"	1/2"	6	On Request	•	
22 mm	F5822M	II	1-1/2"	1-3/16"	1-3/16"	1/2"	6	✓	•	
23 mm	F5823M	II	1-1/2"	1-1/4"	1-1/4"	1/2"	6	✓	•	
24 mm	F5824M	II	1-1/2"	1-1/4"	1-1/4"	25/32"	6	✓		
25 mm	F5825M	II	1-9/16"	1-3/8"	1-3/8"	19/32"	6	✓	•	
26 mm	F5826M	II	1-9/16"	1-3/8"	1-3/8"	19/32"	6	✓		
27 mm	F5827M	II	1-5/8"	1-7/16"	1-7/16"	5/8"	6	✓	•	
28 mm	F5828M	II	1-3/4"	1-1/2"	1-1/2"	3/4"	6	✓		
29 mm	F5829M	II	1-3/4"	1-1/2"	1-1/2"	25/32"	6	✓	•	
30 mm	F5830M	II	1-3/4"	1-5/8"	1-5/8"	25/32"	6	✓	•	
32 mm	F5832M	II	1-3/4"	1-5/8"	1-5/8"	13/16"	6	✓	•	

#### SOCKETS SETS

	12	12
ITEM	F5800AM	S01M
PIECES	14	8
PACKING		
⊘	1	1



**SURTEK**  
TOOLS FOR SPECIALISTS

usa.urrea.com

## 1/2" DRIVE SOCKETS

### 1/2" DRIVE SAE DEEP SOCKETS 12 AND 6 POINT



TYPE I

TYPE II

TYPE III

- Made of high quality micro alloyed steel.
- Super drive® design.
- Nickel - Chrome plated.
- Exceed FEDERAL GGG-W-641E, ASME B107.1, ISO 3315, SAE AS 4283, DIN 3124 standards.



OPENING SIZE	ITEM	TYPE	LENGTH	NUT END OUTSIDE DIAMETER	DRIVE END OUTSIDE DIAMETER	NUT DEPTH	AVAILABLE
3/8"	5312H	I	3-1/32"	9/16"	7/8"	1/2"	✓
7/16"	5314H	I	3-1/32"	5/8"	7/8"	1/2"	✓
1/2"	5316	I	3-3/16"	3/4"	15/16"	1-1/2"	✓
9/16"	5318	I	3-3/16"	13/16"	15/16"	1-1/2"	✓
5/8"	5320	II	3-3/16"	15/16"	15/16"	1-1/2"	✓
11/16"	5322	II	3-3/16"	15/16"	1"	1-1/2"	✓
3/4"	5324	II	3-3/16"	1"	1"	1-1/2"	✓
13/16"	5326	II	3-3/16"	1-1/8"	1-1/8"	1-1/2"	✓
7/8"	5328	II	3-3/16"	1-3/16"	1-3/16"	1-1/2"	✓
15/16"	5330	II	3-3/16"	1-5/16"	1-5/16"	1-1/2"	✓
1"	5332	II	3-3/16"	1-3/8"	1-3/8"	1-1/2"	✓
1-1/16"	5334	II	3-3/16"	1-7/16"	1-7/16"	1-1/2"	✓
1-1/8"	5336	III	3-3/16"	1-9/16"	1-1/2"	1-1/2"	✓
1-1/4"	5340H	III	3-3/16"	1-11/16"	1-1/2"	1-1/2"	✓
1-1/2"	5348H	III	3-3/16"	2"	1-1/2"	1-1/2"	✓

		12	12	12	6	6	6
ITEM	PIECES	54107	5400PH	54117	54103	54118	5300H
PACKING							
AVAILABLE		✓	✓	✓	✓	✓	✓

### 1/2" DRIVE SAE DEEP SOCKETS 12 AND 6 POINT



TYPE I

TYPE II

- Made of Chrome vanadium steel.
- Super drive® design.
- Exceed ASME B107.110 standards.



OPENING SIZE	ITEM	TYPE	LENGTH	NUT END OUTSIDE DIAMETER	DRIVE END OUTSIDE DIAMETER	NUT DEPTH	AVAILABLE
3/8"	F5812HL	I	3-3/32"	19/32"	7/8"	1-15/32"	✓
7/16"	F5814HL	I	3-3/32"	5/8"	7/8"	1-15/32"	✓
1/2"	F5816L	I	3-3/16"	3/4"	1-1/16"	1-1/2"	✓
9/16"	F5818L	I	3-3/16"	27/32"	1-1/16"	1-1/2"	✓
5/8"	F5820L	I	3-3/16"	7/8"	1-1/16"	1-1/2"	✓
11/16"	F5822L	II	3-3/16"	15/16"	1-1/16"	1-1/2"	✓
3/4"	F5824L	II	3-3/16"	1-1/16"	1-1/16"	1-1/2"	✓
13/16"	F5826L	II	3-3/16"	1-3/32"	1-3/32"	1-1/2"	✓
7/8"	F5828L	II	3-3/16"	1-5/32"	1-5/32"	1-1/2"	✓
15/16"	F5830L	II	3-3/16"	1-9/32"	1-9/32"	1-1/2"	✓
1"	F5832L	II	3-3/16"	1-3/8"	1-3/8"	1-1/2"	✓
1-1/16"	F5834L	II	3-3/16"	1-15/32"	1-15/32"	1-1/2"	✓
1-1/8"	F5836L	II	3-3/16"	1-19/32"	1-1/2"	1-1/2"	✓

		12	6
ITEM	PIECES	S11S	F5800HL
PACKING			
AVAILABLE		✓	✓

HAND SOCKETS AND ACCESSORIES

## 1/2" DRIVE SOCKETS

### 1/2" DRIVE METRIC DEEP SOCKETS 12 AND 6 POINT



DEEP SOCKET

METRIC



URREA



TIPO I

TIPO II

TIPO III

- Made of high quality micro alloyed steel.
- Super drive® design.
- Nickel - Chrome plated.
- Exceed FEDERAL GGG-W-641E, ASME B107.1, ISO 3315, SAE AS 4283, DIN 3124 standards.

INDIVIDUAL SOCKETS



OPENING SIZE	ITEM	TYPE	LENGTH	NUT END OUTSIDE DIAMETER	DRIVE END OUTSIDE DIAMETER	NUT DEPTH		AVAILABLE	SOCKETS SETS							
									ITEM 54201	ITEM 54207	ITEM 5400PHM	ITEM 54215	ITEM 54203	ITEM 54204	ITEM 54216	
10 mm	5310M 5310HM	I	3-3/16"	11/16"	31/32"	1-1/2"	6	✓	•	•		•	•	•	•	•
11 mm	5311M 5311HM	I	3-3/16"	3/4"	31/32"	1-1/2"	6	✓	•	•		•	•	•	•	•
12 mm	5312M 5312HM	I	3-3/16"	13/16"	31/32"	1-1/2"	6	✓	•	•		•	•	•	•	•
13 mm	5313M 5313HM	I	3-3/16"	27/32"	31/32"	1-1/2"	6	✓	•	•		•	•	•	•	•
14 mm	5314M 5314HM	I	3-3/16"	7/8"	31/32"	1-1/2"	6	✓	•	•		•	•	•	•	•
15 mm	5315M 5315HM	I	3-3/16"	31/32"	31/32"	1-1/2"	6	✓	•	•		•	•	•	•	•
16 mm	5316M 5316HM	II	3-3/16"	31/32"	31/32"	1-1/2"	6	✓	•	•		•	•	•	•	•
17 mm	5317M 5317HM	II	3-3/16"	31/32"	31/32"	1-1/2"	6	✓	•	•		•	•	•	•	•
18 mm	5318M 5318HM	II	3-3/16"	31/32"	31/32"	1-1/2"	6	✓	•	•		•	•	•	•	•
19 mm	5319M 5319HM	II	3-3/16"	1-3/32"	1-3/32"	1-1/2"	6	✓	•	•		•	•	•	•	•
20 mm	5320M 5320HM	II	3-3/16"	1-3/32"	1-3/32"	1-1/2"	6	✓	•	•		•	•	•	•	•
21 mm	5321M 5321HM	II	3-3/16"	1-3/32"	1-3/32"	1-1/2"	6	✓	•	•		•	•	•	•	•
22 mm	5322M 5322HM	II	3-3/16"	1-3/16"	1-3/16"	1-1/2"	6	✓	•	•		•	•	•	•	•
23 mm	5323M 5323HM	II	3-3/16"	1-7/32"	1-7/32"	1-1/2"	6	✓	•	•		•	•	•	•	•
24 mm	5324M 5324HM	II	3-3/16"	1-9/32"	1-9/32"	1-1/2"	6	✓	•	•		•	•	•	•	•
25 mm	5325M 5325HM	II	3-3/16"	1-9/32"	1-9/32"	1-1/2"	6	✓	•	•		•	•	•	•	•
26 mm	5326M 5326HM	II	3-3/16"	1-3/8"	1-3/8"	1-1/2"	6	✓	•	•		•	•	•	•	•
27 mm	5327M 5327HM	II	3-3/16"	1-13/32"	1-13/32"	1-1/2"	6	✓	•	•		•	•	•	•	•
28 mm	5328M —	II	3-3/16"	1-15/32"	1-15/32"	1-1/2"	6	✓	•	•		•	•	•	•	•
29 mm	5329M —	II	3-3/16"	1-15/32"	1-15/32"	1-1/2"	6	✓	•	•		•	•	•	•	•
30 mm	5330M 5330HM	II	3-3/16"	1-19/32"	1-1/2"	1-1/2"	6	✓	•	•		•	•	•	•	•
31 mm	5331M —	II	3-3/16"	1-19/32"	1-1/2"	1-1/2"	6	✓	•	•		•	•	•	•	•
32 mm	5332M 5332HM	II	3-3/16"	1-23/32"	1-1/2"	1-1/2"	6	✓	•	•		•	•	•	•	•
34 mm	— 5334HM	III	3-3/16"	1-31/32"	1-1/2"	1-1/2"	6	✓				•	•	•	•	•
36 mm	— 5336HM	III	3-3/16"	1-31/32"	1-1/2"	1-1/2"	6	✓				•	•	•	•	•

### 1/2" DRIVE METRIC DEEP SOCKETS 6 POINT



DEEP SOCKET

METRIC



SURTEK



TIPO I

TIPO II

OPENING SIZE	ITEM	TYPE	LENGTH	NUT END OUTSIDE DIAMETER	DRIVE END OUTSIDE DIAMETER	NUT DEPTH		AVAILABLE	SOCKETS SET	
									ITEM	PIECES
10 mm	F5810HLM	I	3-3/16"	11/16"	31/32"	1-1/2"	6	✓	•	•
11 mm	F5811HLM	I	3-3/16"	3/4"	31/32"	1-1/2"	6	✓	•	•
13 mm	F5813HLM	I	3-3/16"	13/16"	31/32"	1-1/2"	6	✓	•	•
15 mm	F5815HLM	II	3-3/16"	13/16"	31/32"	1-1/2"	6	✓	•	•
16 mm	F5816HLM	II	3-3/16"	7/8"	31/32"	1-1/2"	6	✓	•	•
17 mm	F5817HLM	II	3-3/16"	7/8"	31/32"	1-1/2"	6	✓	•	•
18 mm	F5818HLM	II	3-3/16"	31/32"	31/32"	1-1/2"	6	✓	•	•
19 mm	F5819HLM	II	3-3/16"	1-3/32"	1-3/32"	1-1/2"	6	✓	•	•
30 mm	F5830HLM	II	3-3/16"	1-23/32"	1-1/2"	1-1/2"	6	✓	•	•
32 mm	F5832HLM	II	3-3/16"	2"	1-1/2"	1-1/2"	6	✓	•	•
34 mm	F5834HLM	II	3-3/16"	2"	1-1/2"	1-1/2"	6	✓	•	•
36 mm	F5836HLM	II	3-3/16"	2"	1-1/2"	1-1/2"	6	✓	•	•

## 1/2" DRIVE SOCKETS

### 1/2" DRIVE SPLINE SOCKETS



URREA  
SUPERIOR QUALITY AFFORDABLE TOOLS



TYPE II

- Made of high quality micro alloyed steel.
- Nickel - Chrome plated.

INDIVIDUAL SOCKETS									
SPLINE SIZE	ITEM	TYPE	INCHES	MM	LENGTH	NUT END OUTSIDE DIAMETER	DRIVE END OUTSIDE DIAMETER	NUT DEPTH	AVAILABLE
28	5428SPL	II	7/8"	22 mm	5/32"	1/2"	1-5/32"	5/8"	6 ✓

### 1/2" DRIVE FEMALE TORX SOCKETS



URREA  
SUPERIOR QUALITY AFFORDABLE TOOLS



TYPE I

TYPE II

- Made of Chrome vanadium steel.
- Nickel - Chrome plated.
- Heat treated to offer high performance and protect them from corrosion.
- Ideal for application in the automotive industry.

INDIVIDUAL SOCKETS									
OPENING SIZE	ITEM	TYPE	LENGTH	NUT END OUTSIDE DIAMETER	DRIVE END OUTSIDE DIAMETER	NUT DEPTH	AVAILABLE	SOCKETS SET	
E10	5410TX	I	1-1/2"	1/2"	13/16"	1/4"	6 ✓	ITEM 5400TX	
E12	5412TX	I	1-1/2"	9/16"	13/16"	5/16"	6 ✓	PIECES 6	
E14	5414TX	I	1-1/2"	5/8"	13/16"	5/16"	6 ✓	PACKING	
E16	5416TX	I	1-1/2"	3/4"	13/16"	3/8"	6 ✓	1	
E18	5418TX	I	1-1/2"	13/16"	15/16"	7/16"	6 ✓	✓	
E20	5420TX	II	1-1/2"	15/16"	15/16"	1/2"	6 ✓	•	

### 1/2" DRIVE TORX BIT SOCKETS



URREA  
SUPERIOR QUALITY AFFORDABLE TOOLS



543930W

- Made of Chrome vanadium steel.
- Nickel - Chrome plated.
- Heat treated to offer high performance and protect them from corrosion.
- Ideal for application in the automotive industry.

INDIVIDUAL SOCKETS									
TIP SIZE	ITEM	TOTAL LENGTH	TOTAL BIT LENGTH	BIT LENGTH EXPOSED	DRIVE END OUTSIDE DIAMETER	AVAILABLE	SOCKETS SET		
T20	543920W	3-1/4"	1-3/4"	29/32"	7/8"	6 ✓	ITEM 5439C		
T25	543925W	3-1/4"	1-3/4"	29/32"	7/8"	6 ✓	PIECES 7		
T30	543930W	3-1/4"	1-3/4"	29/32"	7/8"	6 ✓	PACKING		
T40	543940W	3-1/4"	1-3/4"	29/32"	7/8"	6 ✓	1		
T45	543945W	3-5/8"	1-7/8"	2-21/32"	7/8"	6 ✓	✓		
T50	543950W	3-5/8"	1-7/8"	2-21/32"	7/8"	6 ✓	•		
T55	543955W	4"	2"	3-1/32"	7/8"	6 ✓	•		

### SPARE PARTS FOR TORX BIT



URREA  
SUPERIOR QUALITY AFFORDABLE TOOLS



R5439T20

ITEM	SIZE	FOR ITEM	TOTAL BIT LENGTH	AVAILABLE
R5439T20	T20	543920W	2-1/4"	1 ✓
R5439T25	T25	543925W	2-1/4"	1 ✓
R5439T30	T30	543930W	2-1/4"	1 ✓
R5439T40	T40	543940W	2-1/4"	1 ✓
R5439T45	T45	543945W	2-11/16"	1 ✓
R5439T50	T50	543950W	2-11/16"	1 ✓
R5439T55	T55	543955W	3-1/64"	1 ✓



## 1/2" DRIVE SOCKETS

### 1/2" DRIVE TORX BIT SOCKETS



• Nickel - Chrome plated.

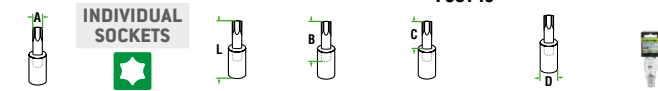

TIP SIZE	ITEM	TOTAL LENGTH	TOTAL BIT LENGTH	BIT LENGTH EXPOSED	DRIVE END OUTSIDE DIAMETER	PACKING	AVAILABLE
T20	<b>F58T20</b>	2-1/8"	1-1/2"	1-3/16"	1/2"	1	On Request
T25	<b>F58T25</b>	2-1/8"	1-1/2"	1-3/16"	1/2"	1	On Request
T30	<b>F58T30</b>	2-1/8"	1-1/2"	1-3/16"	1/2"	1	On Request
T40	<b>F58T40</b>	2-1/8"	1-1/2"	1-3/16"	1/2"	1	On Request
T45	<b>F58T45</b>	2-1/8"	1-1/2"	1-3/16"	1/2"	1	On Request
T50	<b>F58T50</b>	2-1/8"	1-1/2"	1-3/16"	1/2"	1	On Request
T55	<b>F58T55</b>	2-1/8"	1-1/2"	1-3/16"	1/2"	1	On Request



#### SOCKETS SETS

ITEM	F5801T	F5800T
PIECES	7	4
PACKING		
AVAILABLE	On Request	✓

### 1/2" DRIVE LONG TORX BIT SOCKET SET



Content  
Torx bit sockets from T40 to T55 4

ITEM	PIECES	AVAILABLE
<b>F5800TL</b>	4	✓

### 1/2" DRIVE SAE HEXAGONAL BIT SOCKETS



5441-1/4

- Made of high quality micro alloyed steel.
- Super drive® design.
- Nickel - Chrome plated.
- Exceed FEDERAL GGG-W-641E, ASME B107.1, ISO 3315, SAE AS 4283, DIN 3124 standards.

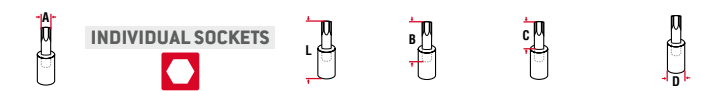

TIP SIZE	ITEM	TOTAL LENGTH	TOTAL BIT LENGTH	BIT LENGTH EXPOSED	DRIVE END OUTSIDE DIAMETER	PACKING	AVAILABLE
1/4"	<b>5441-1/4</b>	3-1/4"	1-3/4"	1-11/16"	15/16"	6	✓
5/16"	<b>5441-5/16</b>	3-1/4"	1-3/4"	1-11/16"	15/16"	6	✓
3/8"	<b>5441-3/8</b>	3-1/4"	1-3/4"	1-11/16"	15/16"	6	✓
7/16"	<b>5441-7/16</b>	3-1/4"	1-3/4"	1-11/16"	15/16"	6	✓
1/2"	<b>5441-1/2</b>	3-5/8"	1-17/8"	2-1/2"	15/16"	6	✓
9/16"	<b>5441-9/16</b>	3-5/8"	1-17/8"	2-5/8"	15/16"	6	✓
5/8"	<b>5441-5/8</b>	4"	2"	2-5/8"	15/16"	6	✓
3/4"	<b>5441-3/4</b>	3-13/16"	2-7/8"	2-3/4"	15/16"	6	✓

#### SOCKETS SET

ITEM	54417
PIECES	7
PACKING	
AVAILABLE	✓

### 1/2" DRIVE SAE HEXAGONAL BIT SOCKETS



F58H14

- Made of Chrome vanadium steel.
- Nickel - Chrome plated.

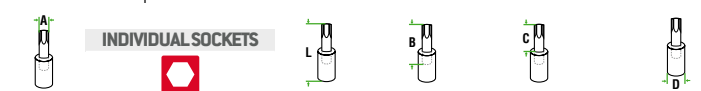

TIP SIZE	ITEM	TOTAL LENGTH	TOTAL BIT LENGTH	BIT LENGTH EXPOSED	DRIVE END OUTSIDE DIAMETER	PACKING	AVAILABLE
1/4"	<b>F58H08</b>	2-1/8"	1-1/2"	1-3/16"	1/2"	1	On Request
5/16"	<b>F58H10</b>	2-1/8"	1-1/2"	1-3/16"	1/2"	1	On Request
3/8"	<b>F58H12</b>	2-1/8"	1-1/2"	1-3/16"	1/2"	1	✓
7/16"	<b>F58H14</b>	2-1/8"	1-1/2"	1-3/16"	1/2"	1	✓
1/2"	<b>F58H16</b>	2-1/8"	1-1/2"	1-3/16"	1/2"	1	✓
9/16"	<b>F58H18</b>	2-1/8"	1-1/2"	1-3/16"	1/2"	1	On Request
5/8"	<b>F58H20</b>	2-1/8"	1-1/2"	1-3/16"	1/2"	1	✓

#### SOCKETS SET

ITEM	F58H01
PIECES	7
PACKING	
AVAILABLE	On Request

## 1/2" DRIVE SOCKETS

### 1/2" DRIVE METRIC HEXAGONAL BIT SOCKETS



HAND SOCKETS AND ACCESSORIES



- Made of Chrome vanadium steel.
- Nickel - Chrome plated.
- Heat treated to offer high performance and protect them from corrosion.
- Ideal for application in the automotive industry.

INDIVIDUAL SOCKETS						
TIP SIZE	ITEM	TOTAL LENGTH	TOTAL BIT LENGTH	BIT LENGTH EXPOSED	DRIVE END OUTSIDE DIAMETER	AVAILABLE
6 mm	<b>54416M</b>	3-1/4"	1-3/4"	1-9/16"	15/16"	✓
8 mm	<b>54418M</b>	7-1/4"	1-3/4"	1-9/16"	15/16"	✓
10 mm	<b>544110M</b>	7-1/4"	1-3/4"	1-9/16"	15/16"	✓
12 mm	<b>544112M</b>	7-1/4"	1-3/4"	1-9/16"	15/16"	✓
14 mm	<b>544114M</b>	7-1/4"	1-7/8"	1-9/16"	15/16"	✓
17 mm	<b>544117M</b>	7-1/4"	2"	1-7/8"	15/16"	✓
19 mm	<b>544119M</b>	3-13/16"	2-7/8"	2-3/4"	15/16"	✓

SOCKETS SET	
ITEM	<b>5441M6</b>
PIECES	<b>6</b>
PACKING	
AVAILABLE	✓

### 1/2" DRIVE METRIC HEXAGONAL BIT SOCKETS



- Made of Chrome vanadium steel.
- Nickel - Chrome plated.

INDIVIDUAL SOCKETS						
TIP SIZE	ITEM	TOTAL LENGTH	TOTAL BIT LENGTH	BIT LENGTH EXPOSED	DRIVE END OUTSIDE DIAMETER	AVAILABLE
6 mm	<b>F58H06M</b>	2-1/8"	1-1/2"	1-3/16"	1/2"	On Request
8 mm	<b>F58H08M</b>	2-1/8"	1-1/2"	1-3/16"	1/2"	On Request
10 mm	<b>F58H10M</b>	2-1/8"	1-1/2"	1-3/16"	1/2"	On Request
12 mm	<b>F58H12M</b>	2-1/8"	1-1/2"	1-3/16"	1/2"	On Request
14 mm	<b>F58H14M</b>	2-1/8"	1-1/2"	1-3/16"	1/2"	On Request
17 mm	<b>F58H17M</b>	2-1/8"	1-1/2"	1-3/16"	1/2"	On Request

SOCKETS SET	
ITEM	<b>F58H01M</b>
PIECES	<b>6</b>
PACKING	
AVAILABLE	On Request

### 1/2" DRIVE SAE HEXAGONAL EXTRA-LONG BIT SOCKETS



- Made of Chrome vanadium steel.
- Nickel - Chrome plated.
- Heat treated to offer high performance and protect them from corrosion.
- Ideal for application in the automotive industry.

INDIVIDUAL SOCKETS							
TIP SIZE	ITEM	TYPE	TOTAL LENGTH	TOTAL BIT LENGTH	BIT LENGTH EXPOSED	DRIVE END OUTSIDE DIAMETER	AVAILABLE
5/16"	<b>5441-5/16L</b>	I	7-1/4"	6-5/8"	5-3/8"	15/16"	✓
3/8"	<b>5441-3/8L</b>	I	7-1/4"	6-5/8"	5-3/8"	15/16"	✓
7/16"	<b>5441-7/16L</b>	II	7-1/4"	6-5/8"	5-3/8"	15/16"	✓
1/2"	<b>5441-1/2L</b>	II	7-1/4"	6-5/8"	5-3/8"	15/16"	✓
9/16"	<b>5441-9/16L</b>	II	7-1/4"	6-5/8"	5-3/8"	15/16"	✓
5/8"	<b>5441-5/8L</b>	II	7-1/4"	6-5/8"	5-3/8"	15/16"	✓

SOCKETS SET	
ITEM	<b>54416L</b>
PIECES	<b>6</b>
PACKING	
AVAILABLE	✓

## 1/2" DRIVE SOCKETS

### 1/2" DRIVE METRIC HEXAGONAL EXTRA-LONG BIT SOCKETS



EXTRA LONG BIT

HEXAGONAL

METRIC

1/2"



URREA



54418ML

- Made of Chrome vanadium steel.
- Nickel - Chrome plated.
- Heat treated to offer high performance and protect them from corrosion.
- Ideal for application in the automotive industry.



INDIVIDUAL SOCKETS



TIP SIZE	ITEM	TYPE	TOTAL LENGTH	TOTAL BIT LENGTH	BIT LENGTH EXPOSED	DRIVE END OUTSIDE DIAMETER	PACKING	AVAILABLE	SOCKETS SET
8 mm	54418ML	I	7-1/4"	5-3/4"	5-3/8"	15/16"	6	✓	5441M5L
10 mm	544110ML	II	7-1/4"	5-3/4"	5-3/8"	15/16"	6	✓	5
12 mm	544112ML	II	7-1/4"	5-3/4"	5-3/8"	15/16"	6	✓	1
14 mm	544114ML	II	7-1/4"	5-3/4"	5-3/8"	15/16"	6	✓	✓
17 mm	544117ML	II	7-1/4"	5-3/4"	5-3/8"	15/16"	6	✓	•

### 1/2" DRIVE RIBE BIT SOCKETS



LONG BIT

RIBE

1/2"



URREA



5443-10M

- Made of Chrome vanadium steel.
- Nickel - Chrome plated.
- Heat treated to offer high performance and protect them from corrosion.
- Ideal for application in the automotive industry.



INDIVIDUAL SOCKETS



TIP SIZE	ITEM	TYPE	TOTAL LENGTH	TOTAL BIT LENGTH	BIT LENGTH EXPOSED	DRIVE END OUTSIDE DIAMETER	PACKING	AVAILABLE	SOCKETS SET
M9	5443-9M	I	4"	2-15/16"	2-7/16"	7/8"	6	✓	5443M5
M10	5443-10M	I	4"	2-15/16"	2-7/16"	7/8"	6	✓	5
M12	5443-12M	II	4"	2-15/16"	2-7/16"	7/8"	6	✓	1
M14	5443-14M	II	4"	2-15/16"	2-7/16"	7/8"	6	✓	•
M16	5443-16M	II	4"	2-15/16"	2-7/16"	7/8"	6	✓	•

**PROFESSIONAL TORQUE**

**SURTEK**  
TOOLS FOR SPECIALISTS



usa.urrea.com

1/2" DRIVE METRIC HEXAGONAL BIT SOCKETS

## 3/4" DRIVE SOCKETS

### 3/4" DRIVE SAE SOCKETS 12 AND 6 POINT



SHORT SOCKET

INCHES



URREA



TYPE I



TYPE II



TYPE III

- Made of high quality micro alloyed steel.
- Super drive® design.
- Nickel - Chrome plated.
- Exceed FEDERAL GGG-W-641, ASME /ANSI B10, ISO 3315, SAE AS 4283, DIN 3123 standards.

#### SOCKETS SETS

	12	6
ITEM	55109	55113
PIECES	18	14
PACKING		
AVAILABLE	✓	✓

OPENING SIZE	INDIVIDUAL SOCKETS			LENGTH	NUT END OUTSIDE DIAMETER	DRIVE END OUTSIDE DIAMETER	NUT DEPTH	AVAILABLE	SOCKETS SETS	
	ITEM	TYPE	TYPE						12	6
3/4"	5524	I	I	2"	1-1/8"	1-5/16"	23/32"	✓	✓	✓
13/16"	5526	I	I	2"	1-7/32"	1-5/16"	23/32"	✓	✓	✓
7/8"	5528	II	II	2"	1-5/16"	1-5/16"	11/16"	✓	•	•
15/16"	5530	5530H	II	2"	1-7/16"	1-7/16"	11/16"	✓	•	•
1"	5532	—	II	2"	1-1/2"	1-1/2"	11/16"	✓	•	•
1-1/16"	5534	5534H	II	2"	1-5/8"	1-5/8"	11/16"	✓	•	•
1-1/8"	5536	5536H	III	2-5/32"	1-5/8"	1-1/2"	1-5/32"	✓	•	•
1-3/16"	5538	5538H	III	2-5/32"	1-3/4"	1-1/2"	1-5/32"	✓	•	•
1-1/4"	5540	5540H	III	2-5/32"	1-7/8"	1-1/2"	1-5/32"	✓	•	•
1-5/16"	5542	5542H	III	2-1/4"	1-7/8"	1-1/2"	1-1/4"	✓	•	•
1-3/8"	5544	—	III	2-1/4"	1-7/8"	1-19/32"	1-1/4"	✓	•	•
1-7/16"	5546	5546H	III	2-13/32"	2"	1-19/32"	1-11/32"	✓	•	•
1-1/2"	5548	5548H	III	2-13/32"	2"	1-19/32"	1-11/32"	✓	•	•
1-9/16"	5550	5550H	III	2-1/2"	2-1/4"	1-3/4"	1-7/16"	✓	•	•
1-5/8"	5552	5552H	III	2-1/2"	2-1/4"	1-3/4"	1-7/16"	✓	•	•
1-11/16"	5554	5554H	III	2-11/16"	2-1/2"	1-3/4"	1-9/16"	✓	•	•
1-3/4"	5556	—	III	2-11/16"	2-1/2"	1-3/4"	1-9/16"	✓	•	•
1-13/16"	5558	5558H	III	2-13/16"	2-1/2"	1-3/4"	1-11/16"	✓	•	•
1-7/8"	5560	5560H	III	2-13/16"	2-5/8"	1-3/4"	1-11/16"	✓	•	•
2"	5564	5564H	III	2-13/16"	2-3/4"	2"	1-11/16"	✓	•	•
2-1/16"	5566	—	III	2-7/8"	2-3/4"	1-7/8"	1-5/8"	✓	•	•
2-1/8"	5568	—	III	3"	2-13/16"	1-7/8"	1-3/4"	✓	•	•
2-3/16"	5570	—	III	3"	2-15/16"	1-7/8"	1-3/4"	✓	•	•
2-1/4"	5572	—	III	3"	3"	1-7/8"	1-13/16"	✓	•	•
2-5/16"	5574	—	III	3-1/16"	3-1/16"	1-15/16"	1-13/16"	✓	•	•
2-3/8"	5576	—	III	3-1/16"	3-1/8"	1-15/16"	1-3/4"	✓	•	•

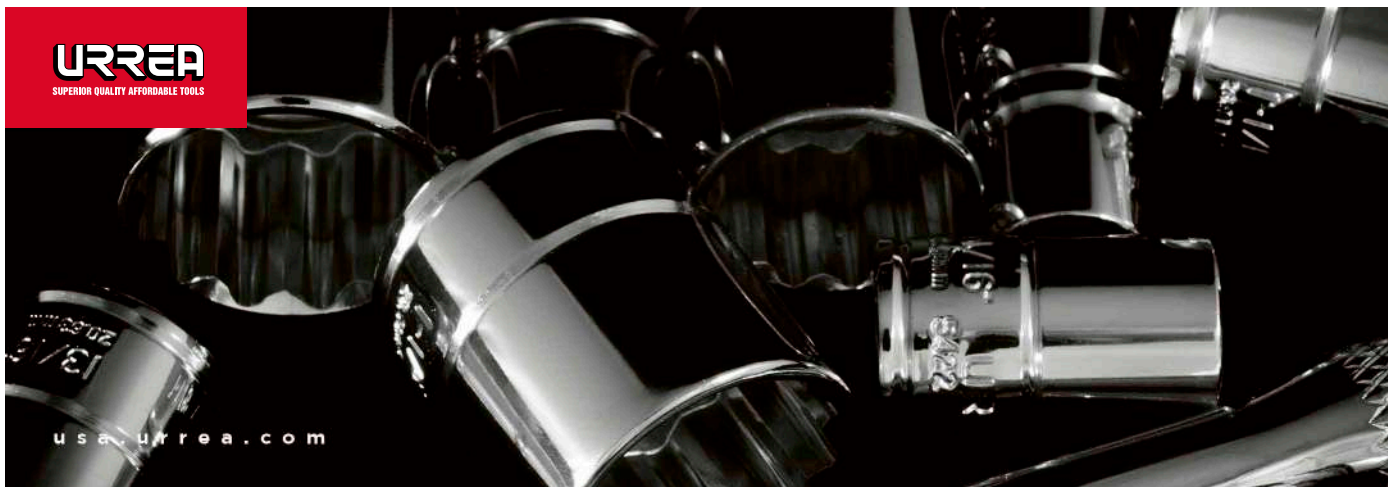

URREA  
SUPERIOR QUALITY AFFORDABLE TOOLS

usa.urrea.com

## 3/4" DRIVE SOCKETS

### 3/4" DRIVE SAE SOCKETS 12 POINT



SHORT SOCKET

INCHES



SURTEK



TYPE I



TYPE II



TYPE III

- Made of Chrome vanadium steel.
- Super drive® design.
- Exceed ASME B107.110 standards.

#### INDIVIDUAL SOCKETS

OPENING SIZE	ITEM	TYPE	LENGTH	NUT END OUTSIDE DIAMETER	DRIVE END OUTSIDE DIAMETER	NUT DEPTH	Ø	AVAILABLE
3/4"	F5924	I	1-7/8"	1-1/8"	1-5/16"	11/16"	1	✓
13/16"	F5926	I	1-7/8"	1-3/16"	1-5/16"	11/16"	1	✓
7/8"	F5928	II	1-7/8"	1-5/16"	1-5/16"	11/16"	1	✓
15/16"	F5930	II	1-7/8"	1-7/16"	1-7/16"	11/16"	1	✓
1"	F5932	II	1-7/8"	1-1/2"	1-1/2"	11/16"	1	✓
1-1/16"	F5934	II	1-7/8"	1-5/8"	1-5/8"	11/16"	1	✓
1-1/8"	F5936	III	2-1/8"	1-5/8"	1-1/2"	1-1/8"	1	✓
1-3/16"	F5938	III	2-1/8"	1-3/4"	1-1/2"	1-1/8"	1	✓
1-1/4"	F5940	III	2-1/8"	1-7/8"	1-1/2"	1-1/8"	1	✓
1-5/16"	F5942	III	2-1/4"	1-7/8"	1-1/2"	1-1/4"	1	✓
1-3/8"	F5944	III	2-1/4"	1-7/8"	1-9/16"	1-1/4"	1	✓
1-7/16"	F5946	III	2-3/8"	2"	1-9/16"	1-5/16"	1	✓
1-1/2"	F5948	III	2-3/8"	2"	1-9/16"	1-5/16"	1	✓
1-9/16"	F5950	III	2-1/2"	2-1/4"	1-11/16"	1-7/16"	1	✓
1-5/8"	F5952	III	2-1/2"	2-1/4"	1-11/16"	1-7/16"	1	✓
1-11/16"	F5954	III	2-5/8"	2-1/2"	1-11/16"	1-9/16"	1	✓
1-3/4"	F5956	III	2-5/8"	2-1/2"	1-11/16"	1-9/16"	1	✓
1-13/16"	F5958	III	2-13/16"	2-1/2"	1-11/16"	1-11/16"	1	✓
1-7/8"	F5960	III	2-13/16"	2-5/8"	1-11/16"	1-11/16"	1	✓
2"	F5964	III	2-13/16"	2-11/16"	2"	1-11/16"	1	✓

**PROFESSIONAL**  
PERFORMANCE

**SURTEK**  
TOOLS FOR SPECIALISTS



usa.urrea.com

1/2" DRIVE METRIC SOCKETS 12 POINT

## 3/4" DRIVE SOCKETS

### 3/4" DRIVE METRIC SOCKETS 12 AND 6 POINT

URREA  
SUPERIOR QUALITY AFFORDABLE TOOLS



HEAVY DUTY SHORT SOCKET METRIC 3/4" 12 6



TYPE II

TYPE III

- Made of high quality micro alloyed steel.
- Super drive® design.
- Nickel - Chrome plated.
- Exceed FEDERAL GGG-W-641E, ASME B107.1, ISO 3315, SAE AS 4283, DIN 3124 standards.

#### INDIVIDUAL SOCKETS

OPENING SIZE	ITEM		TYPE	LENGTH	NUT END OUTSIDE DIAMETER	DRIVE END OUTSIDE DIAMETER	NUT DEPTH	AVAILABLE	SOCKETS SETS	
	12	6							55205	55207
19 mm	5519M	5519HM	II	2"	1-1/4"	1-1/4"	23/32"	6	✓	•
20 mm	5520M	—	II	2"	1-1/4"	1-1/4"	23/32"	6	✓	•
21 mm	5521M	—	II	2"	1-1/4"	1-1/4"	11/16"	6	✓	•
22 mm	5522M	5522HM	II	2"	1-5/16"	1-5/16"	11/16"	6	✓	•
23 mm	5523M	—	II	2"	1-5/16"	1-5/16"	11/16"	6	✓	•
24 mm	5524M	5524HM	II	2"	1-5/16"	1-5/16"	3/4"	6	✓	•
25 mm	5525M	5525HM	II	2"	1-13/32"	1-13/32"	3/4"	6	✓	•
26 mm	5526M	—	II	2"	1-13/32"	1-13/32"	3/4"	6	✓	•
27 mm	5527M	5527HM	II	2"	1-1/2"	1-1/2"	3/4"	6	✓	•
28 mm	5528M	5528HM	II	2"	1-1/2"	1-1/2"	13/16"	6	✓	•
29 mm	5529M	—	II	2-1/4"	1-21/32"	1-1/2"	1-5/32"	6	✓	•
30 mm	5530M	5530HM	III	2-1/4"	1-11/16"	1-1/2"	1-5/32"	6	✓	•
31 mm	5531M	—	III	2-1/4"	1-3/4"	1-1/2"	1-5/32"	6	✓	•
32 mm	5532M	5532HM	III	2-1/4"	1-13/16"	1-1/2"	1-5/32"	1	✓	•
33 mm	5533M	5533HM	III	2-1/4"	1-7/8"	1-1/2"	1-5/32"	1	✓	•
34 mm	5534M	5534HM	III	2-3/8"	1-7/8"	1-5/8"	1-1/4"	1	✓	•
35 mm	5535M	—	III	2-3/8"	1-31/32"	1-5/8"	1-11/32"	1	✓	•
36 mm	5536M	5536HM	III	2-5/8"	2"	1-5/8"	1-11/32"	1	✓	•
38 mm	5538M	5538HM	III	2-5/8"	2-1/32"	1-5/8"	1-11/32"	1	✓	•
40 mm	5540M	—	III	2-5/8"	2-1/4"	1-3/4"	1-7/16"	1	✓	•
41 mm	5541M	5541HM	III	2-5/8"	2-1/4"	1-3/4"	1-7/16"	1	✓	•
42 mm	5542M	—	III	2-5/8"	2-1/4"	1-3/4"	1-7/16"	1	✓	•
44 mm	5544M	—	III	2-3/4"	2-1/2"	1-3/4"	1-9/16"	1	✓	•
46 mm	5546M	5546HM	III	2-5/8"	2-1/2"	1-3/4"	1-11/16"	1	✓	•
50 mm	5550M	5550HM	III	3"	2-3/4"	2"	1-11/16"	1	✓	•
54 mm	5554M	—	III	3"	2-13/16"	1-7/8"	1-3/4"	1	✓	•
55 mm	5555M	—	III	3"	2-15/16"	1-7/8"	1-13/16"	1	✓	•
58 mm	5558M	—	III	3-1/8"	3-1/16"	15/16"	1-13/16"	1	✓	•
60 mm	5560M	—	III	3-1/8"	3-1/8"	1-7/8"	1-15/16"	1	✓	•

ITEM	12	6
	PIECES	17
PACKING		
AVAILABLE	✓	✓

URREA  
SUPERIOR QUALITY AFFORDABLE TOOLS



usa.urrea.com

## 3/4" DRIVE SOCKETS

### 3/4" DRIVE SAE DEEP SOCKETS 6 POINT



SHORT SOCKET

INCHES



URREA



TYPE II



TYPE III

- Made of high quality micro alloyed steel.
- Super drive® design.
- Nickel - Chrome plated.
- Exceed FEDERAL GGG-W-641E, ASME B107.1, ISO 3315, SAE AS 4283, DIN 3124 standards.

INDIVIDUAL SOCKETS										SOCKETS SET	
OPENING SIZE	ITEM	TYPE	LENGTH	NUT END OUTSIDE DIAMETER	DRIVE END OUTSIDE DIAMETER	NUT DEPTH	⊞	⊞	AVAILABLE	ITEM	PIECES
7/8"	5528HL	II	3-1/2"	1-7/16"	1-7/16"	1-1/2"	6	✓	•	55111	13
15/16"	5530HL	II	3-1/2"	1-7/16"	1-7/16"	1-1/2"	6	✓	•	PACKING	
1"	5532HL	II	3-1/2"	1-1/2"	1-1/2"	1-1/2"	6	✓	•		
1-1/16"	5534HL	II	3-1/2"	1-1/2"	1-1/2"	1-1/2"	1	✓	•	1	✓
1-1/8"	5536HL	III	3-1/2"	1-11/16"	1-1/2"	1-1/2"	1	✓	•		
1-3/16"	5538HL	III	3-1/2"	1-11/16"	1-1/2"	1-1/2"	1	✓	•		
1-1/4"	5540HL	III	3-1/2"	1-13/16"	1-1/2"	1-1/2"	1	✓	•		
1-5/16"	5542HL	III	3-1/2"	1-15/16"	1-1/2"	1-1/2"	1	✓	•		
1-3/8"	5544HL	III	3-1/2"	1-15/16"	1-5/8"	1-1/2"	1	✓	•		
1-7/16"	5546HL	III	3-1/2"	1-15/16"	1-5/8"	1-1/2"	1	✓	•		
1-1/2"	5548HL	III	3-1/2"	2-1/16"	1-5/8"	1-1/2"	1	✓	•		
1-9/16"	5550HL	III	3-1/2"	2-1/8"	1-3/4"	1-1/2"	1	✓	•		
1-5/8"	5552HL	III	3-1/2"	2-5/16"	1-3/4"	1-1/2"	1	✓	•		

### 3/4" DRIVE SAE DEEP SOCKETS 6 POINT



SHORT SOCKET

INCHES



SURTEK



TYPE III

- Made of Chrome vanadium steel.
- Super drive® design.
- Exceed ASME B107.110 standards.

INDIVIDUAL SOCKETS									
OPENING SIZE	ITEM	TYPE	LENGTH	NUT END OUTSIDE DIAMETER	DRIVE END OUTSIDE DIAMETER	NUT DEPTH	⊞	⊞	AVAILABLE
1-3/16"	F5938HL	III	3-3/8"	1-9/16"	1-1/2"	1-7/16"	1	✓	
1-1/4"	F5940HL	III	3-3/8"	1-3/4"	1-1/2"	1-7/16"	3	✓	
1-5/16"	F5942HL	III	3-3/8"	1-7/8"	1-1/2"	1-7/16"	1	✓	
1-7/16"	F5946HL	III	3-3/8"	1-7/8"	1-9/16"	1-7/16"	3	✓	

## 1" DRIVE SOCKETS

### 1" DRIVE SAE SOCKETS 12 POINT



SHORT SOCKET

INCHES



URREA



TYPE III

- Made of high quality micro alloyed steel.
- Super drive® design.
- Nickel - Chrome plated.
- Exceed FEDERAL GGG-W-641E, ASME B107.1, ISO 3315, SAE AS 4283, DIN 3124 standards.

INDIVIDUAL SOCKETS

OPENING SIZE	ITEM	TYPE	LENGTH	NUT END OUTSIDE DIAMETER	DRIVE END OUTSIDE DIAMETER	NUT DEPTH	AVAILABLE
1-1/16"	5734	III	1-1/16"	1-13/16"	2"	13/16"	✓
1-1/8"	5736	III	2-3/8"	1-13/16"	2"	13/16"	✓
1-1/4"	5740	III	2-7/16"	1-13/16"	1-3/4"	13/16"	✓
1-5/16"	5742	III	2-1/2"	1-27/32"	1-3/4"	15/16"	✓
1-3/8"	5744	III	2-1/2"	1-29/32"	1-3/4"	15/16"	✓
1-7/16"	5746	III	2-9/16"	2"	1-3/4"	31/32"	✓
1-1/2"	5748	III	2-9/16"	2-1/8"	1-3/4"	1-3/16"	✓
1-5/8"	5752	III	2-3/4"	2-1/4"	1-3/4"	1-7/32"	✓
1-3/4"	5756	III	2-3/4"	1-13/16"	1-31/32"	13/16"	✓
1-13/16"	5758	III	3"	2-9/16"	1-31/32"	1-3/8"	✓
1-7/8"	5760	III	3"	2-21/32"	2-1/8"	1-11/32"	✓
2"	5764	III	3"	2-3/4"	2-5/32"	1-11/32"	✓
2-1/8"	5768	III	3-3/16"	2-15/16"	2-1/4"	1-9/16"	✓
2-3/16"	5770	III	3-3/16"	2-31/32"	2-1/4"	1-5/8"	✓
2-1/4"	5772	III	3-3/16"	3-1/16"	2-1/4"	1-7/16"	✓
2-3/8"	5776	III	3-5/16"	3-7/32"	2-1/4"	1-5/8"	✓
2-1/2"	5780	III	3-7/16"	3-5/16"	2-1/4"	1-5/8"	✓
2-9/16"	5782	III	3-9/16"	3-15/32"	2-1/4"	1-5/8"	✓
2-5/8"	5784	III	3-9/16"	3-1/2"	2-1/4"	2"	✓
2-3/4"	5788	III	3-11/16"	3-3/4"	2-5/8"	2"	✓
2-15/16"	5794	III	3-7/8"	3-15/16"	2-5/8"	2-1/8"	✓
3"	5796	III	4-1/16"	4-1/32"	2-5/8"	2-1/8"	✓
3-1/8"	5800	III	4-1/16"	4"	2-5/8"	2-1/4"	✓
3-1/2"	5812	III	4-3/8"	4-1/32"	2-5/8"	2-1/4"	✓

### 1" DRIVE METRIC SOCKETS 12 POINT



SHORT SOCKET

METRIC



URREA



TYPE III

- Made of high quality micro alloyed steel.
- Super drive® design.
- Nickel - Chrome plated.
- Exceed FEDERAL GGG-W-641E, ASME B107.1, ISO 3315, SAE AS 4283, DIN 3124 standards.

INDIVIDUAL SOCKETS

OPENING SIZE	ITEM	TYPE	LENGTH	NUT END OUTSIDE DIAMETER	DRIVE END OUTSIDE DIAMETER	NUT DEPTH	AVAILABLE
41 mm	5741M	III	2-3/4"	2-1/4"	1-3/4"	1-7/32"	On Request
46 mm	5746M	III	3"	2-9/16"	1-31/32"	1-3/8"	✓
50 mm	5750M	III	3"	2-3/4"	2-5/32"	1-11/32"	✓
55 mm	5755M	III	3-1/8"	2-15/16"	2-1/4"	1-9/16"	✓
60 mm	5760M	III	3-7/16"	3-1/16"	2-1/4"	1-7/16"	✓
65 mm	5765M	III	3-9/16"	3-15/32"	2-1/4"	1-5/8"	On Request
70 mm	5770M	III	3-11/16"	3-3/4"	2-5/8"	2"	✓
75 mm	5775M	III	3-13/16"	3-15/16"	2-5/8"	2-1/8"	✓



## DRIVE ADAPTERS

### DRIVE ADAPTERS



5255



5253



- Made of high quality microalloyed steel.
- Super drive® design.
- Nickel - Chrome plated.
- Exceed FEDERAL GGG-W-641E, ASME B107.1, ISO 3315, SAE AS 4283, DIN 3124 standards.

ITEM	TYPE	OUTPUT DRIVE	FUNCTION	TOTAL LENGTH (A)	MAXIMUM TORQUE	⊞	AVAILABLE
<b>1/4" Drive</b>							
<b>5256</b>	⊞	3/8"	Amplify	1-5/32"	450 in-lb	6	✓
<b>3/8" Drive</b>							
<b>5255</b>	⊞	1/4"	Reduce	1-13/32"	2000 in-lb	6	✓
<b>5253</b>	⊞	1/2"	Amplify	1"	2000 in-lb	6	✓
<b>1/2" Drive</b>							
<b>5254</b>	⊞	3/8"	Reduce	15/16"	2000 in-lb	6	✓
<b>5653</b>	⊞	3/4"	Amplify	1-9/16"	4500 in-lb	6	✓
<b>3/4" Drive</b>							
<b>5453</b>	⊞	1/2"	Reduce	2-1/8"	14000 in-lb	1	✓
<b>5853</b>	⊞	1"	Amplify	2-7/16"	14000 in-lb	1	✓
<b>1" Drive</b>							
<b>5854 *</b>	⊞	3/4"	Reduce	2-3/4"	14000 in-lb	1	✓

## DRIVE ADAPTER SOCKET BIT HOLDER



4771



- Made of high quality micro alloyed steel.
- Super drive® design.
- Nickel - Chrome plated.
- Allows the use of Phillips®, Torx®, flat, etc. hex sockets.
- Exceed FEDERAL GGG-W-641E, ASME B107.1, ISO 3315, SAE AS 4283, DIN 3124 standards.

ITEM	INPUT HEX	TOTAL LENGTH (A)	MAXIMUM TORQUE	⊞	AVAILABLE
<b>1/4" Drive</b>					
<b>4771</b>	1/4"	15/16"	450 in-lb	6	✓

## DRIVE SLIDING T-HANDLES

### SLIDING T-HANDLES



5285



- Made of high quality microalloyed steel.
- Slider box over the bar for two-handed torque applications.
- Exceed FEDERAL GGG-W-641E, ASME B107.1, ISO 3315, SAE AS 4283, DIN 3124 standards.

ITEM	TOTAL LENGTH (A)	⊞	AVAILABLE
<b>1/4" Drive</b>			
<b>4785</b>	4-1/2"	1	✓
<b>3/8" Drive</b>			
<b>5285</b>	8"	1	✓
<b>1/2" Drive</b>			
<b>5484</b>	9-1/2"	1	✓
<b>5485</b>	12-15/16"	1	✓
<b>3/4" Drive</b>			
<b>5685 *</b>	18"	1	✓
<b>1" Drive</b>			
<b>5885 *</b>	28-1/2"	1	✓

### DRIVE ADAPTERS



F5155



- Made of Chrome vanadium steel.
- Exceed ASME B107.1105 standards.

ITEM	TYPE	OUTPUT DRIVE	FUNCTION	TOTAL LENGTH (A)	MAXIMUM TORQUE	⊞	AVAILABLE
<b>1/4" Drive</b>							
<b>F4456</b>	⊞	3/8"	Amplify	1-5/32"	450 in-lb	6	✓
<b>3/8" Drive</b>							
<b>F5155</b>	⊞	1/4"	Reduce	1-13/32"	450 in-lb	6	✓
<b>F5153</b>	⊞	1/2"	Amplify	1"	2000 in-lb	6	✓
<b>1/2" Drive</b>							
<b>F5854</b>	⊞	3/8"	Reduce	15/16"	2000 in-lb	1	✓
<b>F5953</b>	⊞	3/4"	Amplify	1-9/16"	4500 in-lb	1	✓
<b>3/4" Drive</b>							
<b>F5853</b>	⊞	1/2"	Reduce	2-1/6"	4500 in-lb	6	✓

### SLIDING T-HANDLES



F4485

- Made of Chrome vanadium steel.
- Slider box over the bar for two-handed torque applications.
- Exceed FEDERAL GGG-W-641E, ASME B107.1, ISO 3315, SAE AS 4283, DIN 3124 standards.

ITEM	TOTAL LENGTH (A)	⊞	AVAILABLE
<b>1/4" Drive</b>			
<b>F4485</b>	4-1/4"	1	On Request
<b>3/8" Drive</b>			
<b>F5185</b>	8"	1	✓
<b>1/2" Drive</b>			
<b>F5885</b>	9-1/2"	1	✓
<b>3/4" Drive</b>			
<b>F5985</b>	18"	1	✓

# 03 HAND SOCKETS AND ACCESSORIES

## SPEED HANDLES

### SPEED HANDLES



- Made of Chrome vanadium steel.
- Nickel - Chrome plated.
- Exceed FEDERAL GGG-W-641E, ASME B107.1, ISO 3315, SAE AS 4283, DIN 3124 standards.

**BULK**

ITEM	TOTAL LENGTH (A)	⊞	AVAILABLE
<b>1/4" Drive</b>			
5280	7-13/16"	1	✓
<b>1/2" Drive</b>			
5480	10-5/8"	1	✓

## SQUARE DRIVE SCREWDRIVERS

### 1/4" SQUARE DRIVE SCREWDRIVER



- Made of Chrome vanadium steel.
- Facilitates work in hard-to-reach areas.
- Exceed FEDERAL GGG-W-641E, ASME B107.1, ISO 3315, SAE AS 4283, DIN 3124 standards.

**BULK**

ITEM	DESCRIPTION	TOTAL LENGTH (A)	EXPOSED LENGTH (B)	⊞	AVAILABLE
<b>1/4" Drive</b>					
4769	Amber	7"	3"	6	✓

### 1/4" SQUARE DRIVE SCREWDRIVER



- Made of Chrome vanadium steel.
- Heat treated to offer high performance and protect them from corrosion.
- Exceed ASME B107.1105. standards.

ITEM	DESCRIPTION	TOTAL LENGTH (A)	EXPOSED LENGTH (B)	⊞	AVAILABLE
<b>1/4" Drive</b>					
F4469	Azul	7-5/16"	3"	6	✓

## EXTENSIONS

### DRIVE EXTENSIONS



- Made of Chrome vanadium steel.
- Facilitates work in hard-to-reach areas.
- Exceed FEDERAL GGG-W-641E, ASME B107.1, ISO 3315, SAE AS 4283, DIN 3124 standards.

**BULK**

ITEM	DESCRIPTION	TOTAL LENGTH (A)	⊞	AVAILABLE
<b>1/4" Drive</b>				
4760	Regular	3"	6	✓
4761	Regular	6"	6	✓
4762	Regular	10"	6	✓
4764	Regular	12"	6	✓
4763	Regular	14"	6	✓
<b>3/8" Drive</b>				
5260	Regular	3"	6	✓
526006	Regular	6"	6	✓
5261	Regular	8"	6	✓
5262	Regular	12"	6	✓
5263	Regular	18"	6	✓
5264	Regular	24"	1	✓
<b>1/2" Drive</b>				
5460	Regular	2-1/2"	6	✓
5461	Regular	5"	6	✓
5463	Regular	10"	6	✓
546420	Regular	20"	1	✓
546424	Regular	24"	1	✓
546430	Regular	30"	1	✓
546436	Regular	36"	1	✓
<b>3/4" Drive</b>				
5660	Regular	4"	1	✓
5661	Regular	8"	1	✓
5663	Regular	16"	1	✓
<b>1" Drive</b>				
5861	* Regular	8"	1	✓
5863	* Regular	16"	1	✓

### EXTENSIONS



- Made of Chrome vanadium steel.
- Facilitates work in hard-to-reach areas.
- Exceed ASME B107.1105. standards.

ITEM	DESCRIPTION	TOTAL LENGTH (A)	⊞	AVAILABLE
<b>1/4" Drive</b>				
F4460	Regular	3"	6	✓
F4461	Regular	6"	6	✓
<b>3/8" Drive</b>				
F5160	Regular	3"	6	✓
F5161	Regular	6"	6	✓
<b>1/2" Drive</b>				
F5860	Regular	2-1/2"	6	✓
F5861	Regular	5"	6	✓
F5863	Regular	10"	6	✓
<b>3/4" Drive</b>				
F5959	Regular	4"	1	On Request
F5961	Regular	8"	1	✓
F5963	Regular	16"	1	✓





usa.urrea.com

1/4" SQUARE DRIVE SCREWDRIVER

## EXTENSIONS

### EXTENSIONS QUICK RELEASE



5263QR



- Made of high quality micro alloyed steel.
- Facilitates work in hard-to-reach areas.
- Exceed FEDERAL GGG-W-641E, ASME B107.10M standards.

ITEM	DESCRIPTION	TOTAL LENGTH (A)		AVAILABLE
<b>1/4" Drive</b>				
526006QR	Quick Release	6"	6	✓
5263QR	Quick Release	10"	6	✓
<b>1/2" Drive</b>				
5461QR	Quick Release	5"	6	✓
5463QR	Quick Release	10"	6	✓

### FLEXIBLE EXTENSIONS

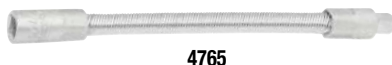

4765

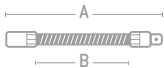

- Facilitates work in hard-to-reach areas.

ITEM	DESCRIPTION	TOTAL LENGTH (A)	SHANK LENGTH (B)		AVAILABLE
<b>1/4" Drive</b>					
4765	Flexible	6"	3-3/4"	6	✓
<b>3/8" Drive</b>					
5268	Flexible	8"	5"	6	✓

### WOBBLE EXTENSIONS



526006W



- Offers 15° flexibility to access hard-to-reach places.

ITEM	DESCRIPTION	TOTAL LENGTH (A)		AVAILABLE
<b>3/8" Drive</b>				
5260W	Wobble	3"	6	✓
526006W	Wobble	6"	6	✓



## HAND ACCESSORIES

### HINGE HANDLES



5467H



- 15% greater resistance than conventional fork design.
- Standards FEDERAL GGG-W-641, ASME B107.10M ISO3315, SAE AS 4283 DIN 3123.

ITEM	TOTAL LENGTH (A)	HEAD WIDTH	HEAD DEPTH	SPARE PART		AVAILABLE
<b>3/8" Drive</b>						
5265H	7-13/16"	57/64"	57/64"	✓ 5265RS	6	✓
<b>1/2" Drive</b>						
5466H	10-5/8"	1-19/64"	1-19/64"	✓ 5466RS	1	✓
5467H	15-3/4"	1-19/64"	1-19/64"	✓ 5466RS	1	✓
5468H	17-7/8"	1-19/64"	1-19/64"	✓ 5466RS	1	✓
<b>3/4" Drive</b>						
5668H *	20-3/16"	1-45/64"	1-45/64"	✓ 5668RS	1	✓
<b>1" Drive</b>						
5868H *	28-1/2"	1-55/64"	1-55/64"	✓ 5868RS	1	✓

### HINGE HANDLES



5467



- 15% greater resistance than conventional fork design.
- Standards FEDERAL GGG-W-641, ASME B107.10M ISO3315, SAE AS 4283 DIN 3123.

ITEM	TOTAL LENGTH (A)	HEAD WIDTH	HEAD DEPTH	SPARE PART		AVAILABLE
<b>1/4" Drive</b>						
4766	5-3/16"	39/64"	39/64"	✓ 4766RS	6	✓
<b>3/8" Drive</b>						
5265	7-13/16"	57/64"	57/64"	✓ 5265RS	6	✓
<b>1/2" Drive</b>						
5466	10-5/8"	1-19/64"	1-19/64"	✓ 5466RS	1	✓
5467	15-3/4"	1-19/64"	1-19/64"	✓ 5466RS	1	✓
5468	17-7/8"	1-19/64"	1-19/64"	✓ 5466RS	1	✓
<b>3/4" Drive</b>						
5668 *	20-3/16"	1-45/64"	1-45/64"	✓ 5668RS	1	✓
<b>1" Drive</b>						
5868 *	28-1/2"	1-55/64"	1-55/64"	✓ 5868RS	1	✓

## HAND ACCESSORIES

### HINGE HANDLES AND SPARE PARTS



F5868



- Made of Chrome vanadium steel.
- Exceed ASME B107.110 standard.
- Models F5867 and F5868 with improved design that increases their resistance to torque, exceeding the norm up to 60%.

**BULK**

ITEM	TOTAL LENGTH (A)	HEAD WIDTH	HEAD DEPTH	SPARE PART	☐	AVAILABLE
<b>3/8" Drive</b>						
F5165	8"	1/2"	3/8"	✓ F5165R	1	✓
<b>1/2" Drive</b>						
F5867	15"	11/16"	1/2"	✓ F5868R	1	✓
F5868	18"	11/16"	1/2"	✓ F5868R	1	✓
<b>3/4" Drive</b>						
F5968	20"	1"	3/4"	✓ F5968R	1	✓

### DRIVE HINGE HANDLES



5468B



- 15% greater resistance than conventional fork design.
- FEDERAL GGG-W-641, ASME B107.10M ISO3315, SAE AS 4283 DIN 3123 standards.



ITEM	TOTAL LENGTH (A)	HEAD WIDTH	HEAD DEPTH	SPARE PART	☐	AVAILABLE
<b>1/2" Drive</b>						
5468B	17-7/8"	1-19/64"	1-19/64"	✓ 5466RS	1	✓
<b>3/4" Drive</b>						
5668B	20-3/16"	1-45/64"	1-45/64"	✓ 5668RS	1	✓
<b>1" Drive</b>						
5868B	28-1/2"	1-55/64"	1-55/64"	✓ 5868RS	1	✓

### SPARE PARTS FOR HINGE HANDLES



4766RS  
5265RS  
5466RS  
5668RS  
5868RS

ITEM	FOR ITEM	☐	AVAILABLE
4766RS	4766	1	✓
5265RS	5265 y 5265H	1	On Request
5466RS	Improved product: 5468H, 5468, 5467H, 5467, 5466H, 5466 y 5468B	1	✓
5668RS	Improved product: 5668H, 5668 y 5668B	1	✓
5868RS	5868H, 5868 y 5868B	1	✓

## L-HANDLES

### L-HANDLES



5486

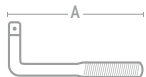

- Made of high quality micro alloyed steel.
- Robust design with no moving parts.
- Exceed FEDERAL GGG-W-641, ASME B107.10M, ISO3315, SAE AS 4283, DIN 3123 standards.

**BULK**

ITEM	TOTAL LENGTH (A)	☐	AVAILABLE
<b>1/2" Drive</b>			
5486	7-13/16"	6	✓
<b>3/4" Drive</b>			
5686	16"	1	✓
<b>1" Drive</b>			
5886	30"	1	✓

### L-HANDLES



F5886



- Made of Chrome vanadium steel.
- Nickel - Chrome plated.
- Exceed ASME B107.1105. standard.

**BULK**

ITEM	TOTAL LENGTH (A)	☐	AVAILABLE
<b>1/2" Drive</b>			
F5886	9"	6	✓
<b>3/4" Drive</b>			
F5986	16"	1	✓

**REVERSIBLE RATCHETS**

**QUICK RELEASE RATCHETS**



HAND SOCKETS AND ACCESSORIES

**REVERSIBLE RATCHETS**



**4749H**

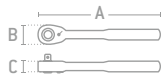

- Screwless mechanism, less chance of accidental disarmament.
- Greater resistance thanks to its body forged in Chrome-vanadium microalloy steel.
- Simple repair.
- Retaining ring makes easier access to internal mechanism.
- Exceed ASME B107.110 2012. standard.

ITEM	TOTAL LENGTH (A)	HEAD WIDTH (B)	HEAD DEPTH (C)	QUICK RELEASE	TEETH	SWING ARC	HEAD TYPE	SPARE PARTS	📦	AVAILABLE
<b>1/4" Drive</b>										
<b>4749H</b>	5"	25/32"	7/16"	✓	48	7.5°	Pear	✓ 4749RKA	1	✓
<b>3/8" Drive</b>										
<b>5249H</b>	7"	1-3/32"	17/32"	✓	48	7.5°	Pear	✓ 5249RKA	1	✓
<b>1/2" Drive</b>										
<b>5449H</b>	10-1/8"	1-17/32"	45/64"	✓	48	7.5°	Pear	✓ 5449RKA	1	✓
<b>3/4" Drive</b>										
<b>5649H</b>	20"	2-17/32"	1-1/16"	✓	24	15°	Pear	✓ 5649RK	1	✓

**REVERSIBLE RATCHETS**



**4749IX**

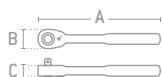

- Ergonomic bimaterial handle for enhanced grip.
- Made of Chrome vanadium steel.
- Nickel-chrome plated.
- Exceed ASME B107.110 standards.

ITEM	TOTAL LENGTH (A)	HEAD WIDTH (B)	HEAD DEPTH (C)	QUICK RELEASE	TEETH	SWING ARC	HEAD TYPE	📦	AVAILABLE
<b>1/4" Drive</b>									
<b>4749IX</b>	5-1/4"	1"	37/64"	✓	72	5°	Pear	1	On Request
<b>3/8" Drive</b>									
<b>5249IX</b>	7-7/8"	1-1/4"	47/64"	✓	72	5°	Pear	1	On Request
<b>1/2" Drive</b>									
<b>5449IX</b>	10-1/4"	1-5/8"	55/64"	✓	72	5°	Pear	1	On Request

## REVERSIBLE RATCHETS



NEW

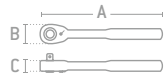

F4450X

- Ergonomic bimaterial handle for enhanced grip.
- Made of Chrome vanadium steel.
- Nickel-chrome plated.
- Exceed ASME B107.110 standards.



ITEM	TOTAL LENGTH (A)	HEAD WIDTH (B)	HEAD DEPTH (C)	TEETH	QUICK RELEASE	SWING ARC	HEAD TYPE	☞	AVAILABLE
<b>1/4" Drive</b>									
F4450X	6-7/64"	1-1/16"	1/2"	72	✓	5°	Pear	1	On Request
<b>3/8" Drive</b>									
F5150X	8-5/64"	1-5/16"	3/4"	72	✓	5°	Pear	1	On Request
<b>1/2" Drive</b>									
F5850X	10-3/64"	1-37/64"	27/32"	72	✓	5°	Pear	1	On Request

## REVERSIBLE RATCHETS

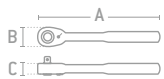

4749

- Screwless mechanism, less chance of accidental disarmament.
- Greater resistance thanks to its body forged in Chrome-vanadium microalloy steel.
- Simple repair.
- Retaining ring makes easier access to internal mechanism.
- Exceed ASME B107.110 2012. standard.



ITEM	TOTAL LENGTH (A)	HEAD WIDTH (B)	HEAD DEPTH (C)	QUICK RELEASE	TEETH	SWING ARC	HEAD TYPE	SPARE PARTS	☞	AVAILABLE
<b>1/4" Drive</b>										
4749	5"	13/16"	7/16"	✓	48	7.5°	Pear	✓ 4749RKA	1	✓
<b>3/8" Drive</b>										
5249	7"	1-1/16"	19/32"	✓	48	7.5°	Pear	✓ 5249RKA	6	✓
<b>1/2" Drive</b>										
5449	10-1/8"	1-1/2"	23/32"	✓	48	7.5°	Pear	✓ 5449RKA	1	✓
<b>3/4" Drive</b>										
5649	20"	2-1/2"	1-1/16"	✓	24	15°	Pear	✓ 5649RK	1	✓
<b>1" Drive</b>										
5849	26"	2-1/2"	1-1/8"	✓	24	15°	Pear	✓ 5849RK	1	✓

## REVERSIBLE RATCHETS



NEW

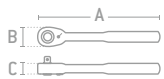

4749I

- Made of Chrome vanadium steel.
- Nickel-chrome plated.
- Exceed ASME B107.110 standards.



ITEM	TOTAL LENGTH (A)	HEAD WIDTH (B)	HEAD DEPTH (C)	QUICK RELEASE	TEETH	SWING ARC	HEAD TYPE	SPARE PARTS	☞	AVAILABLE
<b>1/4" Drive</b>										
4749I	5 1/4"	1"	37/64"	✓	45	8°	Pear	✓	1	On Request
<b>3/8" Drive</b>										
5249I	7 7/8"	1-1/4"	3/4"	✓	45	8°	Pear	✓	1	On Request
<b>1/2" Drive</b>										
5449I	10 1/4"	1-5/8"	27/32"	✓	45	8°	Pear	✓	1	On Request

## REVERSIBLE RATCHETS

**SURTEK**  
TOOL CO. INCORPORATED

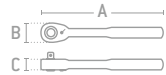

Knurled handle

- Quick Release system, facilitates quick release of socket.
- Non-slip knurled handle.
- Made of Chrome vanadium steel.
- Exceed ASME B107.110 standard.

ITEM	TOTAL LENGTH (A)	HEAD WIDTH (B)	HEAD DEPTH (C)	TEETH	QUICK RELEASE	SWING ARC	HEAD TYPE	SPARE PARTS	☞	AVAILABLE
<b>1/4" Drive</b>										
<b>F4449</b>	5-1/32"	31/32"	15/32"	72	✓	5°	Pear	✓ F4449RK	3	✓
<b>3/8" Drive</b>										
<b>F5149</b>	7"	1-27/64"	9/16"	72	✓	5°	Pear	✓ F5149RK	3	✓
<b>1/2" Drive</b>										
<b>F5849</b>	10-1/8"	1-19/32"	11/16"	72	✓	5°	Pear	✓ F5849RK	6	✓
<b>3/4" Drive</b>										
<b>F5949</b>	20"	2-1/2"	1-1/16"	24	✓	15°	Pear	✗	1	✓

HAND SOCKETS AND ACCESSORIES

## REVERSIBLE RATCHETS



**URREA**  
TOOL CO. INCORPORATED

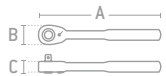

- Screwless mechanism, less chance of accidental disarmament.
- Greater resistance thanks to its body forged in Chrome-vanadium micro alloyed steel.
- Simple repair.
- Retaining ring makes easier acces to internal mechanism.
- Exceed ASME B107.110 2012 standard.

ITEM	TOTAL LENGTH (A)	HEAD WIDTH (B)	HEAD DEPTH (C)	QUICK RELEASE	TEETH	SWING ARC	HEAD TYPE	SPARE PARTS	☞	AVAILABLE
<b>3/8" Drive</b>										
<b>5249B</b>	7"	1-7/64"	19/32"	✓	48	7.5°	Pear	✓ 5249RKA	1	✓
<b>1/2" Drive</b>										
<b>5449B</b>	10-1/8"	1-1/2"	45/64"	✓	48	7.5°	Pear	✓ 5449RKA	1	✓

## 1/2" AND 1" DRIVE LONG HANDLE QUICK RELEASE REVERSIBLE RATCHET



**URREA**  
TOOL CO. INCORPORATED

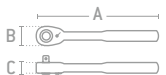

5450

- Quick Release design.
- Long handle for greater leverage.
- ASME B107.110 standard.

ITEM	TOTAL LENGTH (A)	HEAD WIDTH (B)	HEAD DEPTH (C)	QUICK RELEASE	TEETH	SWING ARC	HEAD TYPE	SPARE PARTS	☞	AVAILABLE
<b>1/2" Drive</b>										
<b>5450</b>	16"	1-1/2"	45/64"	✓	48	7.5°	Pear	✓ 5449RKA	1	✓
<b>1" Drive</b>										
<b>5850 *</b>	36"	2-31/64"	1-1/16"	✓	24	15°	Pear	✓ 5849RK	1	✓

\* **BULK**

## REVERSIBLE RATCHETS

### 3/8" AND 1/2" DRIVE STUBBY QUICK RELEASE REVERSIBLE RATCHETS



5249S

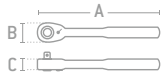

- Quick Release design.
- Allows to work in confined spaces.
- ASME B107.110 standard.



ITEM	TOTAL LENGTH (A)	HEAD WIDTH (B)	HEAD DEPTH (C)	QUICK RELEASE	TEETH	SWING ARC	HEAD TYPE	SPARE PARTS	☞	AVAILABLE	
<b>3/8" Drive</b>											
	5249S	4-11/16"	25/32"	7/16"	✓	60	6°	Pear	✗	1	✓
<b>1/2" Drive</b>											
	5449S	5-1/2"	15/16"	19/32"	✓	60	6°	Pear	✗	1	✓

### 1/4", 3/8" AND 1/2" DRIVE OFFSET HANDLE QUICK RELEASE REVERSIBLE RATCHETS



4749G

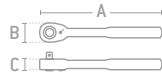

- Made of Chrome vanadium steel.
- Quick Release design.
- Plastic protection that prevents scratches on metal parts.
- ASME B107.110 standard.



ITEM	TOTAL LENGTH (A)	HEAD WIDTH (B)	HEAD DEPTH (C)	QUICK RELEASE	TEETH	SWING ARC	HEAD TYPE	SPARE PARTS	☞	AVAILABLE	
<b>1/4" Drive</b>											
	4749G	6"	7/8"	15/32"	✓	72	5°	Pear	✓ 4749GRK	1	✓
<b>3/8" Drive</b>											
	5249G	8"	1-1/8"	9/16"	✓	72	5°	Pear	✓ 5249GRK	1	✓
<b>1/2" Drive</b>											
	5449G	10"	1-1/2"	3/4"	✓	72	5°	Pear	✓ 5449GRK	1	✓

### 1/4", 3/8" AND 1/2" DRIVE ROUND HEAD QUICK RELEASE REVERSIBLE RATCHETS



4752A

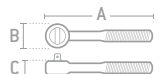

- ASME B107.110 2012 standard.



ITEM	TOTAL LENGTH (A)	HEAD WIDTH (B)	HEAD DEPTH (C)	QUICK RELEASE	TEETH	SWING ARC	HEAD TYPE	SPARE PARTS	☞	AVAILABLE	
<b>1/4" Drive</b>											
	4752A	5-1/8"	29/32"	7/16"	✓	45	8°	Round	✗	1	✓
<b>3/8" Drive</b>											
	5252A	7-3/4"	15/16"	5/8"	✓	45	8°	Round	✓ 5252ARK	1	✓
<b>1/2" Drive</b>											
	5452A	10-1/8"	1-19/32"	11/16"	✓	45	8°	Round	✓ 5452ARK	1	✓



## REVERSIBLE RATCHETS

### ROUND-HEAD™ REVERSIBLE RATCHETS

**SURTEK**  
TOOL CO. PRESENTS



**F4452A**

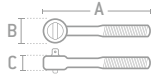

- Made of Chrome vanadium steel.
- Non-slip knurled handle.
- Exceed ASME B107.110 standard.

ITEM	TOTAL LENGTH (A)	HEAD WIDTH (B)	HEAD DEPTH (C)	QUICK RELEASE	TEETH	SWING ARC	HEAD TYPE	SPARE PARTS	📦	AVAILABLE
<b>1/4" Drive</b>										
<b>F4452A</b>	5-1/8"	63/64"	1/2"	✓	45	8°	Redonda	✘	1	✓
<b>3/8" Drive</b>										
<b>5152A</b>	7"	1-13/32"	37/64"	✓	45	8°	Redonda	✘	3	✓
<b>1/2" Drive</b>										
<b>F5852A</b>	10"	1-5/8"	23/32"	✓	45	8°	Redonda	✘	6	✓

### 1/2" DRIVE FLEX HEAD QUICK RELEASE REVERSIBLE RATCHET

**URREA**  
HEAVY DUTY RATCHETS

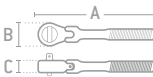

- Made of Chrome vanadium steel.
- Ideal for reaching nuts at different angles.
- Exceed ASME B107.110 standard.

ITEM	TOTAL LENGTH (A)	HEAD WIDTH (B)	HEAD DEPTH (C)	QUICK RELEASE	TEETH	SWING ARC	HEAD TYPE	SPARE PARTS	📦	AVAILABLE
<b>5457</b>	11-11/16"	1-15/32"	3/4"	✓	45	8°	Redonda	✓ 5452ARK	1	✓

### DOUBLE-DRIVE QUICK RELEASE RATCHETS

**URREA**  
HEAVY DUTY RATCHETS



**544952N**

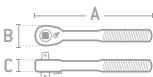

- Made of Chrome vanadium steel.
- Ratchet 2 in 1.
- Exceed ASME B107.110 standard.

ITEM	TOTAL LENGTH (A)	HEAD WIDTH (B)	HEAD DEPTH (C)	QUICK RELEASE	TEETH	SWING ARC	HEAD TYPE	SPARE PARTS	📦	AVAILABLE
<b>1/4" and 3/8" Drive</b>										
<b>524947N</b>	7"	1-1/8"	19/32"	✓	24	15°	Pera	✘	1	On Request
<b>3/8" and 1/2" Drive</b>										
<b>544952N</b>	10-1/8"	1-1/2"	11/16"	✓	24	15°	Pera	✓ 544952NRK	1	✓
<b>3/4" and 1" Drive</b>										
<b>564958N *</b>	20"	2-9/16"	1-1/16"	✓	24	15°	Pera	✘	1	On Request

\* **BULK**

## REVERSIBLE RATCHETS

### MULTI-DRIVE REVERSIBLE RATCHETS



F5150



F5851

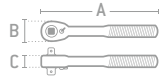

- Made of Chrome vanadium steel.
- Non-slip knurled handle.
- Exceed ASME B107.110 standard.

ITEM	TOTAL LENGTH (A)	HEAD WIDTH (B)	HEAD DEPTH (C)	TEETH	SWING ARC	HEAD TYPE	SPARE PARTS	🔓	AVAILABLE
<b>1/4" and 3/8" Drive</b>									
<b>F5150</b>	7"	1-1/4"	21/32"	72	5°	Pear	x	1	✓
<b>1/4", 3/8" and 1/2" Drive</b>									
<b>F5851</b>	7"	1-5/16"	3/4"	72	5°	Pear	x	1	✓
<b>3/8" and 1/2" Drive</b>									
<b>F5850</b>	10"	1-19/32"	53/64"	72	5°	Pear	x	1	✓

### 1/4" DRIVE & 1/4" HEX BIT RATCHET



F4450

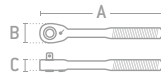

- Made of Chrome vanadium steel.
- Non-slip knurled handle.
- Compatible with 1/4" hex driver bits.
- Exceed ASME B107.110 standard.

ITEM	DESCRIPTION	TOTAL LENGTH (A)	HEAD WIDTH (B)	HEAD DEPTH (C)	TEETH	SWING ARC	HEAD TYPE	SPARE PARTS	🔓	AVAILABLE
<b>1/4" Drive</b>										
<b>F4450</b>	For bits and 1/4" sockets	5"	15/16"	1/2"	72	5°	Pear	x	1	✓

### 1/2" DRIVE MULTI-POSITION QUICK RELEASE REVERSIBLE RATCHET

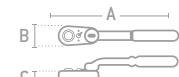

- Made of Chrome vanadium steel.
- Quick Release design.
- Ideal for reaching nuts at different angles.
- Compatible with 1/4" hex driver bits.
- Reversible, rotates 360°.
- Exceed ASME B107.110 standard.

ITEM	TOTAL LENGTH (A)	HEAD WIDTH (B)	HEAD DEPTH (C)	QUICK RELEASE	TEETH	SWING ARC	HEAD TYPE	SPARE PARTS	🔓	AVAILABLE
<b>1/2" Drive</b>										
<b>5452FL</b>	12"	1-15/32"	11/16"	✓	45	8°	Pera	x	1	✓

## REVERSIBLE RATCHETS

### 1/2" DRIVE SCAFFOLD STRIKING REVERSIBLE RATCHET

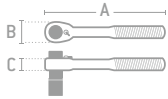

- Ideal for assembling racks and shelves.
- Perforation for use of mail or security chain.
- Removable striking head that reduces vibration and distortion at the time of impact.
- Exceed ASME B107.110 standard.

**BULK**

ITEM	TOTAL LENGTH(A)	HEAD WIDTH (B)	HEAD DEPTH (C)	QUICK RELEASE	TEETH	SWING ARC	HEAD TYPE	SPARE PARTS	☐	AVAILABLE
<b>5449SC</b>	7/8"	10-1/8"	1-15/32"	11/16"	24	15°	Pera	*	1	✓

### 1/2" DRIVE STRUCTURAL QUICK RELEASE REVERSIBLE RATCHET

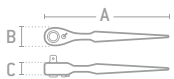

- Quick Release design.
- Conical handle to align objects.
- Exceed ASME B107.110 standard.

**BULK**

ITEM	TOTAL LENGTH(A)	HEAD WIDTH (B)	HEAD DEPTH (C)	QUICK RELEASE	TEETH	SWING ARC	HEAD TYPE	SPARE PARTS	☐	AVAILABLE
<b>5449 14BL</b>	10-1/8"	1-1/2"	11/16"	✓	48	7.5°	Pera	*	1	✓

### SPARE PARTS FOR RATCHETS



4749RKA / 5249RKA / 5449RKA

544952NRK

4749GRK / 5249GRK / 5449GRK

5649RK

5252ARK / 5452ARK

5649QRK

5849RK

ITEM	FOR ITEM	☐	AVAILABLE
<b>4749RKA</b>	4749 y 4749H	1	✓
<b>4749GRK</b>	4749G	1	✓
<b>5249RKA</b>	5249, 5249H y 5249B	1	✓
<b>5249GRK</b>	5249G	1	✓
<b>5252ARK</b>	5252A	1	✓
<b>5449RKA</b>	5449, 5449H, 5449B y 5450	1	✓
<b>5449GRK</b>	5449G	1	✓
<b>5452ARK</b>	5452A y 5457	1	✓
<b>544952NRK</b>	544952N	1	On Request
<b>5649RK</b>	5649H y 5649	1	✓
<b>5649QRK</b>	5649Q	1	✓
<b>5849RK</b>	5849 y 5850	1	On Request

## REVERSIBLE RATCHETS

### SPARE PARTS FOR RATCHETS



**SURTEK**  
TOOLS FOR SPECIALISTS









F4449XRK



F4449RK



ITEM	FOR ITEM		AVAILABLE
 F4449XRK	F4449X	1	On Request
 F5149XRK	F5149X	1	On Request
 F5849XRK	F5849X	1	On Request
 F5849RK	F5849	1	On Request
 F5149RK	F5149	1	On Request
 F4449RK	F4449	1	On Request

## UNIVERSAL JOINTS

### UNIVERSAL JOINTS



**URREA**  
SUPERIOR QUALITY AFFORDABLE TOOLS



5270



- Made of chrome vanadium steel.
- Provides benefits of a hinged handle to any fixed handle.
- Exceed FEDERAL GGG-W-641E, ASME B107.1, ISO 3315, SAE AS 4283, DIN 3124 standards.

ITEM	TOTAL LENGTH (A)	MAX TORQUE RESISTANCE		AVAILABLE
<b>1/4" Drive</b>				
 4770	1-5/16"	250 in-lb	6	✓
<b>3/8" Drive</b>				
 5270	1-15/16"	750 in-lb	6	✓
<b>1/2" Drive</b>				
 5470	2-7/8"	2000 in-lb	6	✓
<b>3/4" Drive</b>				
 5670	3-3/4"	4000 in-lb	1	✓
<b>1" Drive</b>				
 5870	5-5/8"	4000 in-lb	1	✓

### UNIVERSAL JOINTS





**SURTEK**  
TOOLS FOR SPECIALISTS



103507



- Made of chrome vanadium steel.
- Provides benefits of a hinged handle to any fixed handle.
- Exceed ASME B107.110 2012 standard.

ITEM	TOTAL LENGTH (A)	MAX TORQUE RESISTANCE		AVAILABLE
<b>1/4" Drive</b>				
 102105	3"	250 in-lb	6	On Request
<b>3/8" Drive</b>				
 103507	1-15/16"	750 in-lb	6	On Request
<b>1/2" Drive</b>				
 104915	2-5/8"	2000 in-lb	6	On Request



CLASS	TYPE	PAGE	BRAND	
			URREA	SURTEK
Impact socket sets and accessories	1" impact sockets and accessories set	156	•	
	1/2" impact sockets and accessories set	156	•	
	3/4" impact sockets and accessories set	156	•	
Impact sockets	1/4" impact sockets	157	•	
	3/8" impact sockets	159	•	
	1/2" impact sockets	162	•	
	3/4" impact sockets	170	•	•
	1" impact sockets	175	•	
	1-1/2" impact sockets	178	•	
	2-1/2" impact sockets	179	•	
Impact accessories	Impact adapters	179	•	
	Impact extensions	180	•	•
	Impact drive handles	181	•	
	Impact L-handle	181	•	
	Impact universal joint	181	•	

[usa.urrea.com](http://usa.urrea.com)

We are constantly improving our products, that is why the information, characteristics and availability of them can change without prior notice.

# 04 IMPACT SOCKETS AND ACCESSORIES

## 1/2" DRIVE SAE AND METRIC IMPACT SOCKET SETS INTERCHANGEABLE UNIVERSAL 6 POINT

### 1/2" DRIVE SAE IMPACT SOCKET SET INTERCHANGEABLE UNIVERSAL 6 POINT



**9 PIECES**

Sizes
7/16"
1/2"
9/16"
5/8"
11/16"
3/4"
13/16"
7/8"
15/16"
Adaptor



- Attachment system with UAS.
- Ball design which allows a 25° working angle.
- Ideal for use on stubborn fasteners.

ITEM	PIECES	AVAILABLE
74143	9	1 ✓

## PINS & O-RINGS ASSEMBLY INSTRUCTIONS



- 1 Insert the accessory to be used onto the impact socket.
- 2 Insert the retention pin in the socket, passing through the accessory's male drive.
- 3 Place the retention o-ring on the impact socket's groove.

All Urrea impact sockets and accessories with 1/2" to 2-1/2" drive feature the pin and o-ring fastening system.

Avoid possible injuries caused by the use or handling of impact sockets or accessories with larger sizes.



## 3/4" DRIVE IMPACT SOCKET SETS WITH ACCESSORIES



**12 PIECES**



- 25% less expensive and 30% lighter than acquire an impact wrench set with same sizes.

Content Item	Size	Content Item	Size
7512L	3/4"	7518L	1-1/8"
7513L	13/16"	7519L	1-3/16"
7514L	7/8"	7520L	1-1/4"
7515L	15/16"	7521L	1-5/16"
7516L	1"	7657	Impact handle
7517L	1-1/16"	5496	Metal case

ITEM	PIECES	AVAILABLE
750012LH	12	1 ✓

## 3/4" DRIVE METRIC DEEP IMPACT SOCKET SET WITH ACCESSORIES



**13 PIECES**



- 25% less expensive and 30% lighter than acquire an impact wrench set with same sizes.

Content Item	Size	Content Item	Size
7519ML	19 mm	7525ML	25 mm
7520ML	20 mm	7526ML	26 mm
7521ML	21 mm	7527ML	27 mm
7522ML	22 mm	7530ML	30 mm
7523ML	23 mm	7532ML	32 mm
7524ML	24 mm		

Content Item	Size
7657	Impact handle
5496	Metal case

ITEM	PIECES	AVAILABLE
750013MLH	13	1 ✓

## 1" DRIVE IMPACT SOCKET SETS WITH ACCESSORIES



**14 PIECES**



- 25% less expensive and 30% lighter than acquire an impact wrench set with same sizes.

Content Item	Size	Content Item	Size
10022L	1-3/8"	10030L	1-7/8"
10023L	1-7/16"	10031L	1-15/16"
10024L	1-1/2"	10032L	2"
10025L	1-9/16"	10034L	2-1/8"
10026L	1-5/8"	10035L	2-3/16"
10028L	1-3/4"	10657	Impact handle
10029L	1-13/16"	5696	Metal Case

ITEM	PIECES	AVAILABLE
10000LH	14	1 ✓

## 1" DRIVE METRIC DEEP IMPACT SOCKET SET WITH ACCESSORIES



**14 PIECES**



- 25% less expensive and 30% lighter than acquire an impact wrench set with same sizes.

Content Item	Size	Content Item	Size
10024M	24 mm	10046M	46 mm
10027M	27 mm	10050M	50 mm
10030M	30 mm	10055M	55 mm
10032M	32 mm	10060M	60 mm
10033M	33 mm	10065M	65 mm
10036M	36 mm	10657	Impact handle
10041M	41 mm	5696	Metal Case

ITEM	PIECES	AVAILABLE
15201H	14	1 ✓

## 1/4" DRIVE IMPACT SOCKETS

### 1/4" DRIVE SAE IMPACT SOCKETS 6 POINT



SHORT SOCKET

INCHES



URREA



TYPE I

TYPE II

- Super Drive design reduces stress away from fastener corners distributing contact stresses over a large area of the socket, minimizing slippage.
- Exceed ASME B107.110.2012 & DIN3124 standards.

INDIVIDUAL SOCKETS								PACKING		SOCKET SET	
OPENING SIZE	ITEM	TYPE	LENGTH	NUT END OUTSIDE DIAMETER	DRIVE END OUTSIDE DIAMETER	NUT DEPTH	6	AVAILABLE	ITEM	PIECES	
3/16"	6906H	I	15/16"	5/16"	1/2"	1/8"	6	✓	69106	10	
1/4"	6908H	I	15/16"	3/8"	1/2"	1/8"	6	✓			
9/32"	6909H	I	15/16"	7/16"	1/2"	1/8"	6	✓			
5/16"	6910H	I	15/16"	7/16"	1/2"	1/8"	6	✓			
11/32"	6911H	II	15/16"	1/2"	1/2"	3/16"	6	✓			
3/8"	6912H	II	15/16"	9/16"	9/16"	3/16"	6	✓			
7/16"	6914H	II	15/16"	5/8"	5/8"	1/4"	6	✓			
1/2"	6916H	II	15/16"	3/4"	3/4"	1/4"	6	✓			
9/16"	6918H	II	15/16"	3/4"	3/4"	1/4"	6	✓			
5/8"	6920H	II	15/16"	13/16"	13/16"	1/4"	6	✓			

### 1/4" DRIVE METRIC IMPACT SOCKETS 6 POINT



SHORT SOCKET

METRIC



URREA



TYPE I

TYPE II

- Super Drive design reduces stress away from fastener corners distributing contact stresses over a large area of the socket, minimizing slippage.
- Exceed ASME B107.110.2012 & DIN3124 standards.

INDIVIDUAL SOCKETS								PACKING		SOCKET SET	
OPENING SIZE	ITEM	TYPE	LENGTH	NUT END OUTSIDE DIAMETER	DRIVE END OUTSIDE DIAMETER	NUT DEPTH	6	AVAILABLE	ITEM	PIECES	
4 mm	6904M	I	15/16"	1/4"	1/2"	1/8"	6	✓	69206	13	
5 mm	6905M	I	15/16"	5/16"	1/2"	1/8"	6	✓			
5.5 mm	69055M	I	15/16"	5/16"	1/2"	1/8"	6	✓			
6 mm	6906M	I	15/16"	3/8"	1/2"	1/8"	6	✓			
7 mm	6907M	I	15/16"	3/8"	1/2"	1/8"	6	✓			
8 mm	6908M	I	15/16"	1/2"	1/2"	1/8"	6	✓			
9 mm	6909M	II	15/16"	1/2"	1/2"	1/8"	6	✓			
10 mm	6910M	II	15/16"	9/16"	9/16"	1/8"	6	✓			
11 mm	6911M	II	15/16"	5/8"	5/8"	3/16"	6	✓			
12 mm	6912M	II	15/16"	11/16"	11/16"	3/16"	6	✓			
13 mm	6913M	II	15/16"	11/16"	11/16"	3/16"	6	✓			
14 mm	6914M	II	15/16"	3/4"	3/4"	1/4"	6	✓			
15 mm	6915M	II	15/16"	13/16"	13/16"	1/4"	6	✓			

# 04 IMPACT SOCKETS AND ACCESSORIES

## 1/4" DRIVE IMPACT SOCKETS

### 1/4" DRIVE SAE DEEP IMPACT SOCKETS 6 POINT



DEEP SOCKET

INCHES



CHROME-MOLYBDENUM

ZINC PHOSPHATE FINISH

URREA



TYPE I

- Super Drive design reduces stress away from fastener corners distributing contact stresses over a large area of the socket, minimizing slippage.
- Exceed ASME B107.110.2012 & DIN3124 standards.

#### INDIVIDUAL SOCKETS

OPENING SIZE	ITEM	TYPE	LENGTH	NUT END OUTSIDE DIAMETER	DRIVE END OUTSIDE DIAMETER	NUT DEPTH	6 POINT	AVAILABLE
1/4"	6508H	I	2"	3/8"	1/2"	1/8"	6	✓
11/32"	6511H	I	2"	1/2"	1/2"	1/8"	6	✓

### 1/4" DRIVE METRIC DEEP IMPACT SOCKETS 6 POINT



DEEP SOCKET

METRIC



CHROME-MOLYBDENUM

ZINC PHOSPHATE FINISH

URREA



TYPE I



TYPE II

- Super Drive design reduces stress away from fastener corners distributing contact stresses over a large area of the socket, minimizing slippage.
- Exceed ASME B107.110.2012 & DIN3124 standards.

#### INDIVIDUAL SOCKETS

OPENING SIZE	ITEM	TYPE	LENGTH	NUT END OUTSIDE DIAMETER	DRIVE END OUTSIDE DIAMETER	NUT DEPTH	6 POINT	AVAILABLE
5 mm	6505HM	I	2"	5/16"	1/2"	1/8"	6	✓
6 mm	6506HM	I	2"	3/8"	1/2"	1/8"	6	✓
7 mm	6507HM	I	2"	7/16"	1/2"	1/8"	6	✓
8 mm	6508HM	I	2"	7/16"	1/2"	1/8"	6	✓
9 mm	6509HM	II	2"	9/16"	9/16"	3/16"	6	✓
10 mm	6510HM	II	2"	1/2"	1/2"	3/16"	6	✓
11 mm	6511HM	II	2"	5/8"	5/8"	1/4"	6	On Request
12 mm	6512HM	II	2"	11/16"	11/16"	1/4"	6	✓
13 mm	6513HM	II	2"	3/4"	3/4"	1/4"	6	✓
14 mm	6514HM	II	2"	3/4"	3/4"	5/16"	6	✓
15 mm	6515HM	II	2"	13/16"	13/16"	5/16"	6	✓

#### SOCKET SET

ITEM	6
PIECES	69212
PACKING	11
6 POINT	1
AVAILABLE	✓



## 3/8" DRIVE IMPACT SOCKETS

### 3/8" DRIVE SAE IMPACT SOCKETS 6 POINT



SHORT SOCKET

INCHES



CHROME-MOLYBDENUM

ZINC PHOSPHATE FINISH

URREA



TYPE I



TYPE II

- Super Drive design reduces stress away from fastener corners distributing contact stresses over a large area of the socket, minimizing slippage.
- Exceed ASME B107.110.2012 & DIN3124 standards.

INDIVIDUAL SOCKETS									
OPENING SIZE	ITEM	TYPE	LENGTH	NUT END OUTSIDE DIAMETER	DRIVE END OUTSIDE DIAMETER	NUT DEPTH	6	AVAILABLE	
1/4"	7208H	I	1-3/16"	7/16"	3/4"	1/8"	6	✓	
9/32"	7209H	I	1-3/16"	1/2"	3/4"	1/8"	6	✓	
5/16"	7210H	I	1-3/16"	1/2"	3/4"	1/8"	6	✓	
3/8"	7212H	I	1-3/16"	9/16"	3/4"	1/4"	6	✓	
7/16"	7214H	I	1-3/16"	11/16"	3/4"	1/4"	6	✓	
1/2"	7216H	II	1-3/16"	3/4"	3/4"	1/4"	6	✓	
9/16"	7218H	II	1-3/16"	3/4"	3/4"	1/4"	6	✓	
5/8"	7220H	II	1-3/16"	15/16"	15/16"	1/4"	6	✓	
11/16"	7222H	II	1-3/16"	15/16"	15/16"	5/16"	6	✓	
3/4"	7224H	II	1-3/16"	1"	1"	3/8"	6	✓	

### 3/8" DRIVE METRIC IMPACT SOCKETS 6 POINT



SHORT SOCKET

METRIC



CHROME-MOLYBDENUM

ZINC PHOSPHATE FINISH

URREA



TYPE I



TYPE II

- Super Drive design reduces stress away from fastener corners distributing contact stresses over a large area of the socket, minimizing slippage.
- Exceed ASME B107.110.2012 & DIN3124 standards.

INDIVIDUAL SOCKETS										SOCKET SET	
OPENING SIZE	ITEM	TYPE	LENGTH	NUT END OUTSIDE DIAMETER	DRIVE END OUTSIDE DIAMETER	NUT DEPTH	6	AVAILABLE		ITEM	PIECES
8 mm	7208M	I	1-3/16"	1/2"	3/4"	1/8"	6	✓		72202	11
9 mm	7209M	I	1-3/16"	9/16"	3/4"	1/8"	6	✓			
10 mm	7210M	I	1-3/16"	5/8"	3/4"	1/8"	6	✓			
11 mm	7211M	I	1-3/16"	11/16"	3/4"	1/4"	6	✓			
12 mm	7212M	II	1-3/16"	3/4"	3/4"	1/4"	6	✓			
13 mm	7213M	II	1-3/16"	3/4"	3/4"	1/4"	6	✓			
14 mm	7214M	II	1-3/16"	3/4"	3/4"	1/4"	6	✓			
15 mm	7215M	II	1-3/16"	7/8"	7/8"	1/4"	6	✓			
16 mm	7216M	II	1-3/16"	15/16"	15/16"	1/4"	6	✓			
17 mm	7217M	II	1-3/16"	15/16"	15/16"	1/4"	6	✓			
18 mm	7218M	II	1-3/16"	1"	1"	5/16"	6	✓			
19 mm	7219M	II	1-3/16"	1"	1"	3/8"	6	✓			

# 04 IMPACT SOCKETS AND ACCESSORIES

## 3/8" DRIVE IMPACT SOCKETS

### 3/8" DRIVE SAE DEEP IMPACT SOCKETS 12 AND 6 POINT



DEEP SOCKET

INCHES



CHROME-MOLYBDENUM

ZINC PHOSPHATE FINISH

URREA



TYPE I

TYPE II

- Super Drive design reduces stress away from fastener corners distributing contact stresses over a large area of the socket, minimizing slippage.
- Exceed ASME B107.110.2012 & DIN3124 standards.

INDIVIDUAL SOCKETS										
OPENING SIZE	ITEM	TYPE	LENGTH	NUT END OUTSIDE DIAMETER	DRIVE END OUTSIDE DIAMETER	NUT DEPTH	6	6	6	AVAILABLE
5/16"	7710	-	2-1/2"	1/2"	3/4"	1/8"	6	6	6	On Request
5/16"	-	7710H	2-1/2"	1/2"	3/4"	1/8"	6	6	6	✓
3/8"	-	7712H	2-1/2"	9/16"	3/4"	1/8"	6	6	6	✓
7/16"	-	7714H	2-1/2"	11/16"	3/4"	3/16"	6	6	6	✓
1/2"	-	7716H	2-1/2"	3/4"	3/4"	3/16"	6	6	6	✓
9/16"	-	7718H	2-1/2"	15/16"	15/16"	1/4"	6	6	6	✓
5/8"	-	7720H	2-1/2"	15/16"	15/16"	1/4"	6	6	6	✓
11/16"	-	7722H	2-1/2"	1"	1"	5/16"	6	6	6	✓
3/4"	-	7724H	2-1/2"	1"	1"	5/16"	6	6	6	✓

### 3/8" DRIVE METRIC DEEP IMPACT SOCKETS 6 POINT



DEEP SOCKET

METRIC



CHROME-MOLYBDENUM

ZINC PHOSPHATE FINISH

URREA



TYPE I

TYPE II

- Super Drive design reduces stress away from fastener corners distributing contact stresses over a large area of the socket, minimizing slippage.
- Exceed ASME B107.110.2012 & DIN3124 standards.

INDIVIDUAL SOCKETS											SOCKET SETS	
OPENING SIZE	ITEM	TYPE	LENGTH	NUT END OUTSIDE DIAMETER	DRIVE END OUTSIDE DIAMETER	NUT DEPTH	6	6	6	AVAILABLE	ITEM	PIECES
7 mm	7007M	I	2-9/16"	7/16"	3/4"	1/8"	6	6	6	✓	72216	17
8 mm	7008M	I	2-9/16"	1/2"	3/4"	1/8"	6	6	6	✓	72212	11
9 mm	7009M	I	2-9/16"	9/16"	3/4"	1/8"	6	6	6	✓		
10 mm	7010M	I	2-9/16"	9/16"	3/4"	1/8"	6	6	6	✓		
11 mm	7011M	I	2-9/16"	11/16"	3/4"	1/4"	6	6	6	✓		
12 mm	7012M	II	2-9/16"	3/4"	3/4"	1/4"	6	6	6	✓		
13 mm	7013M	II	2-9/16"	3/4"	3/4"	1/4"	6	6	6	✓		
14 mm	7014M	II	2-9/16"	3/4"	3/4"	1/4"	6	6	6	✓		
15 mm	7015M	II	2-9/16"	7/8"	7/8"	1/4"	6	6	6	✓		
16 mm	7016M	II	2-9/16"	15/16"	15/16"	1/4"	6	6	6	✓		
17 mm	7017M	II	2-9/16"	15/16"	15/16"	1/4"	6	6	6	✓		
18 mm	7018M	II	2-9/16"	1"	1"	5/16"	6	6	6	✓		
19 mm	7019M	II	2-9/16"	1"	1"	3/8"	6	6	6	✓		
21 mm	7021M	II	2-9/16"	1-1/8"	1-1/8"	3/8"	6	6	6	✓		
22 mm	7022M	II	2-9/16"	1-1/8"	1-1/8"	3/8"	6	6	6	✓		
23 mm	7023M	II	2-9/16"	1-3/16"	1-3/16"	3/8"	6	6	6	✓		
24 mm	7024M	II	2-9/16"	1-1/4"	1-1/4"	3/8"	6	6	6	✓		

# 3/8" DRIVE 6-POINT MAGNETIC IMPACT SOCKETS

**MAGNETIC  
IMPACT**



**ON REQUESTING LOADED MAGNET** Deep sockets feature a spring, allowing the bolt or pin to push into the socket's body while it is being screwed in.



**U MAGNET** | **CHROME MOLYBDENUM**

**MAGNETIC CYLINDER** A magnetic cylinder keeps the fastener engaged when it would otherwise fall out.

IMPACT SOCKETS AND ACCESSORIES

## 3/8" DRIVE SAE MAGNETIC IMPACT SOCKETS 6 POINT

**HEAVY DUTY** **SHORT SOCKET** **INCHES** **3/4"** **6** **MAGNETIC SOCKET** **CHROME-MOLYBDENUM**

**URREA**



OPENING SIZE	INDIVIDUAL SOCKETS		LENGTH	NUT END OUTSIDE DIAMETER	DRIVE END OUTSIDE DIAMETER	NUT DEPTH	6	AVAILABLE
	ITEM	TYPE						
3/8"	7212HM	I	1-3/16"	9/16"	3/8"	5/32"	6	✓
7/16"	7214HM	I	1-3/16"	11/16"	3/8"	3/16"	6	✓
1/2"	7216HM	II	1-3/16"	3/4"	3/8"	3/16"	6	✓

## 3/8" DRIVE METRIC MAGNETIC IMPACT SOCKETS 6 POINT

**HEAVY DUTY** **SHORT SOCKET** **METRIC** **3/4"** **6** **MAGNETIC SOCKET** **CHROME-MOLYBDENUM**

**URREA**



OPENING SIZE	INDIVIDUAL SOCKETS		LENGTH	NUT END OUTSIDE DIAMETER	DRIVE END OUTSIDE DIAMETER	NUT DEPTH	6	AVAILABLE
	ITEM	TYPE						
10 mm	7210MHM	I	1-3/16"	15.87 mm	19.05 mm	3.96 mm	6	✓
13 mm	7213MHM	II	1-3/16"	19.05 mm	22.2 mm	4.76 mm	6	✓

## 3/8" DRIVE SAE MAGNETIC DEEP IMPACT SOCKETS 6 POINT

**HEAVY DUTY** **DEEP SOCKET** **INCHES** **3/4"** **6** **MAGNETIC SOCKET** **CHROME-MOLYBDENUM**

**URREA**



OPENING SIZE	INDIVIDUAL SOCKETS		LENGTH	NUT END OUTSIDE DIAMETER	DRIVE END OUTSIDE DIAMETER	NUT DEPTH	6	AVAILABLE
	ITEM	TYPE						
3/8"	7712HM	I	2-3/16"	9/16"	3/4"	1/2"	6	✓
7/16"	7714HM	I	2-3/16"	11/16"	3/4"	15/16"	6	✓
1/2"	7716HM	II	2-3/16"	3/4"	3/4"	15/16"	6	✓

## 3/8" DRIVE METRIC MAGNETIC DEEP IMPACT SOCKETS 6 POINT

**HEAVY DUTY** **DEEP SOCKET** **METRIC** **3/4"** **6** **MAGNETIC SOCKET** **CHROME-MOLYBDENUM**

**URREA**



OPENING SIZE	INDIVIDUAL SOCKETS		LENGTH	NUT END OUTSIDE DIAMETER	DRIVE END OUTSIDE DIAMETER	NUT DEPTH	6	AVAILABLE
	ITEM	TYPE						
10 mm	7010MHM	I	2-1/2"	15.87 mm	19.05 mm	3.96 mm	6	✓
13 mm	7013MHM	II	2-1/2"	19.05 mm	19.05 mm	4.76 mm	6	✓

# 04 IMPACT SOCKETS AND ACCESSORIES

## 3/8" DRIVE TORX BIT IMPACT SOCKETS

HEAVY DUTY TORX 3/8" CHROME-MOLYBDENUM

URREA



IMPACT SOCKETS AND ACCESSORIES



729020W

INDIVIDUAL SOCKETS						
TIP SIZE	ITEM	TOTAL LENGTH	EXPOSED TIP LENGTH	BIT LENGTH	DRIVE END OUTSIDE DIAMETER	AVAILABLE
T10	729010W	2"	5/8"	1-5/16"	3/4"	6 ✓
T15	729015W	2"	5/8"	1-5/16"	3/4"	6 On Request
T20	729020W	2"	5/8"	1-5/16"	3/4"	6 ✓
T25	729025W	2"	5/8"	1-5/16"	3/4"	6 ✓
T27	729027W	2"	5/8"	1-5/16"	3/4"	6 ✓
T30	729030W	2"	5/8"	1-5/16"	3/4"	6 ✓
T40	729040W	2"	5/8"	1-5/16"	3/4"	6 ✓
T45	729045W	2"	5/8"	1-5/16"	3/4"	6 ✓
T50	729050W	2"	5/8"	1-5/16"	3/4"	6 ✓

SOCKET SET	
ITEM	72900W
PIECES	9
PACKING	
AVAILABLE	1 ✓

## 3/8" DRIVE SAE HEXAGONAL BIT IMPACT SOCKETS

HEAVY DUTY HEXAGONAL INCHES 3/8" CHROME-MOLYBDENUM

URREA



7290-1/4

INDIVIDUAL SOCKETS						
TIP SIZE	ITEM	TOTAL LENGTH	EXPOSED TIP LENGTH	BIT LENGTH	DRIVE END OUTSIDE DIAMETER	AVAILABLE
5/32"	7290-5/32	2"	5/8"	1-5/16"	3/4"	6 ✓
1/4"	7290-1/4	2"	5/8"	1-5/16"	3/4"	6 ✓
5/16"	7290-5/16	2"	5/8"	1-5/16"	3/4"	6 ✓
3/8"	7290-3/8	2"	5/8"	1-5/16"	3/4"	6 ✓
1/2"	7290-1/2	2"	5/8"	1-5/16"	3/4"	6 ✓

## 3/8" DRIVE METRIC HEXAGONAL BIT IMPACT SOCKETS

HEAVY DUTY HEXAGONAL METRIC 3/8" CHROME-MOLYBDENUM

URREA



7290-6M

INDIVIDUAL SOCKETS						
TIP SIZE	ITEM	TOTAL LENGTH	EXPOSED TIP LENGTH	BIT LENGTH	DRIVE END OUTSIDE DIAMETER	AVAILABLE
5 mm	7290-5M	2"	5/8"	1-5/16"	3/4"	6 ✓
6 mm	7290-6M	2"	5/8"	1-5/16"	3/4"	6 ✓
8 mm	7290-8M	2"	5/8"	1-5/16"	3/4"	6 ✓

## 1/2" DRIVE IMPACT SOCKETS

### 1/2" DRIVE SAE SHORT AND DEEP IMPACT SOCKET SET 6 POINT

HEAVY DUTY INCHES 1/2" 6 CHROME-MOLYBDENUM

URREA



ZINC PHOSPHATE FINISH

7 PIECES	Sizes
	Sockets
	7416H 1/2"
	7418H 9/16"
	7420H 5/8"
	7422H 11/16"
	Deep sockets
	7324H 3/4"
	7326H 13/16"
	7328H 7/8"



INCLUDES SOCKET RAIL AND CLIPS

ITEM	PIECES	AVAILABLE
7400CA	7	1 ✓



## 1/2" DRIVE IMPACT SOCKETS

### 1/2" DRIVE SAE IMPACT SOCKETS 12 POINT



SHORT SOCKET

INCHES



CHROME-MOLYBDENUM

ZINC PHOSPHATE FINISH

URREA



TYPE I

TYPE II

TYPE III

SOCKET SET	
ITEM	74101
PIECES	11
INCLUDE SOCKET RAIL AND CLIPS	
PACKING	
AVAILABLE	✓

INDIVIDUAL SOCKETS									
OPENING SIZE	ITEM	TYPE	LENGTH	NUT END OUTSIDE DIAMETER	DRIVE END OUTSIDE DIAMETER	NUT DEPTH	AVAILABLE		
3/8"	7412	I	1-1/2"	5/8"	7/8"	9/16"	6	✓	•
7/16"	7414	I	1-1/2"	11/16"	7/8"	9/16"	6	✓	•
1/2"	7416	I	1-1/2"	13/16"	15/16"	9/16"	6	✓	•
9/16"	7418	I	1-1/2"	7/8"	15/16"	9/16"	6	✓	•
5/8"	7420	II	1-1/2"	1"	1"	9/16"	6	✓	•
11/16"	7422	II	1-1/2"	1-1/8"	1-1/8"	9/16"	6	✓	•
3/4"	7424	II	1-1/2"	1-1/8"	1-1/8"	9/16"	6	✓	•
13/16"	7426	II	1-1/2"	1-3/16"	1-3/16"	9/16"	6	✓	•
7/8"	7428	II	1-1/2"	1-3/8"	1-3/8"	9/16"	6	✓	•
15/16"	7430	II	1-1/2"	1-3/8"	1-3/8"	9/16"	6	✓	•
1"	7432	II	1-1/2"	1-7/16"	1-7/16"	9/16"	6	✓	•
1-1/16"	7434	II	1-13/16"	1-1/2"	1-1/2"	11/16"	1	✓	•
1-1/8"	7436	III	1-13/16"	1-9/16"	1-9/16"	3/4"	1	✓	•
1-3/16"	7438	III	1-7/8"	1-3/4"	1-1/2"	15/16"	1	✓	•
1-1/4"	7440	III	1-7/8"	1-3/4"	1-1/2"	15/16"	1	✓	•
1-5/16"	7442	III	1-7/8"	1-15/16"	1-1/2"	15/16"	1	✓	•
1-3/8"	7444	III	1-7/8"	1-15/16"	1-1/2"	15/16"	1	✓	•
1-7/16"	7446	III	2-3/16"	2"	1-1/2"	15/16"	1	✓	•
1-1/2"	7448	III	2-3/16"	2"	1-1/2"	15/16"	1	✓	•

### 1/2" DRIVE SAE IMPACT SOCKETS 6 POINT



SHORT SOCKET

INCHES



CHROME-MOLYBDENUM

ZINC PHOSPHATE FINISH

URREA



NEW



TYPE I

TYPE II

TYPE III

SOCKET SETS					
ITEM	7401C	74106	7402C	74104	74102
PIECES	19	19	15	15	11
INCLUDE SOCKET RAIL AND CLIPS					
PACKING					
AVAILABLE	✓	✓	✓	✓	✓

INDIVIDUAL SOCKETS									
OPENING SIZE	ITEM	TYPE	LENGTH	NUT END OUTSIDE DIAMETER	DRIVE END OUTSIDE DIAMETER	NUT DEPTH	AVAILABLE		
3/8"	7412H	I	1-1/2"	5/8"	7/8"	9/16"	6	✓	•
7/16"	7414H	I	1-1/2"	11/16"	7/8"	9/16"	6	✓	•
1/2"	7416H	I	1-1/2"	3/4"	15/16"	9/16"	6	✓	•
9/16"	7418H	I	1-1/2"	7/8"	15/16"	9/16"	6	✓	•
5/8"	7420H	II	1-1/2"	1"	1"	9/16"	6	✓	•
11/16"	7422H	II	1-1/2"	1-1/16"	1-1/16"	9/16"	6	✓	•
3/4"	7424H	II	1-1/2"	1-1/8"	1-1/8"	9/16"	6	✓	•
13/16"	7426H	II	1-1/2"	1-3/16"	1-3/16"	9/16"	6	✓	•
7/8"	7428H	II	1-1/2"	1-1/4"	1-1/4"	9/16"	6	✓	•
15/16"	7430H	II	1-1/2"	1-5/16"	1-5/16"	9/16"	6	✓	•
1"	7432H	II	1-1/2"	1-3/8"	1-3/8"	9/16"	6	✓	•
1-1/16"	7434H	II	1-13/16"	1-1/2"	1-1/2"	11/16"	1	✓	•
1-1/8"	7436H	III	1-13/16"	1-9/16"	1-9/16"	3/4"	1	✓	•
1-3/16"	7438H	III	1-15/16"	1-3/4"	1-1/2"	15/16"	1	✓	•
1-1/4"	7440H	III	1-15/16"	1-3/4"	1-1/2"	15/16"	1	✓	•
1-5/16"	7442H	III	1-15/16"	1-15/16"	1-1/2"	15/16"	1	✓	•
1-3/8"	7444H	III	1-15/16"	1-15/16"	1-1/2"	15/16"	1	✓	•
1-7/16"	7446H	III	1-15/16"	2"	1-1/2"	15/16"	1	✓	•
1-1/2"	7448H	III	1-15/16"	2"	1-1/2"	15/16"	1	✓	•

# 04 IMPACT SOCKETS AND ACCESSORIES

## 1/2" DRIVE IMPACT SOCKETS

### 1/2" DRIVE METRIC IMPACT SOCKETS 12 POINT



SHORT SOCKET

METRIC



CHROME-MOLYBDENUM

ZINC PHOSPHATE FINISH

URREA



TYPE I

TYPE II

SOCKET SET	
ITEM	74201
PIECES	15
PACKING	INCLUDE SOCKET RAIL AND CLIPS
AVAILABLE	1

OPENING SIZE	INDIVIDUAL SOCKETS		LENGTH	NUT END OUTSIDE DIAMETER	DRIVE END OUTSIDE DIAMETER	NUT DEPTH	AVAILABLE	AVAILABLE
	ITEM	TYPE						
10 mm	7410MT	I	1-1/2"	7/8"	7/8"	5/8"	6	✓
11 mm	7411MT	I	1-1/2"	7/8"	7/8"	5/8"	6	✓
12 mm	7412MT	I	1-1/2"	15/16"	15/16"	5/8"	6	✓
13 mm	7413MT	I	1-1/2"	15/16"	15/16"	5/8"	6	✓
14 mm	7414MT	I	1-1/2"	15/16"	15/16"	5/8"	6	✓
15 mm	7415MT	I	1-1/2"	1"	1"	5/8"	6	✓
16 mm	7416MT	II	1-1/2"	1"	1"	5/8"	6	✓
17 mm	7417MT	II	1-1/2"	1-1/8"	1-1/8"	5/8"	6	✓
18 mm	7418MT	II	1-1/2"	1-1/8"	1-1/8"	5/8"	6	✓
19 mm	7419MT	II	1-1/2"	1-1/8"	1-1/8"	5/8"	6	✓
20 mm	7420MT	II	1-1/2"	1-5/16"	1-5/16"	5/8"	6	✓
21 mm	7421MT	II	1-1/2"	1-5/16"	1-5/16"	5/8"	6	✓
22 mm	7422MT	II	1-1/2"	1-5/16"	1-5/16"	5/8"	6	✓
23 mm	7423MT	II	1-1/2"	1-3/8"	1-3/8"	5/8"	6	✓
24 mm	7424MT	II	1-1/2"	1-3/8"	1-3/8"	5/8"	6	✓

### 1/2" DRIVE METRIC IMPACT SOCKETS 6 POINT



SHORT SOCKET

METRIC



CHROME-MOLYBDENUM

ZINC PHOSPHATE FINISH

URREA



NEW



TYPE I

TYPE II

TYPE III

ITEM	SOCKET SETS				
	7402MC	74206	7401MC	74204M	74202M
PIECES	24	24	15	15	10
PACKING	INCLUDE SOCKET RAIL AND CLIPS	INCLUDE SOCKET RAIL AND CLIPS	INCLUDE SOCKET RAIL AND CLIPS	INCLUDE SOCKET RAIL AND CLIPS	INCLUDE SOCKET RAIL AND CLIPS
AVAILABLE	1	1	1	1	1

OPENING SIZE	INDIVIDUAL SOCKETS		LENGTH	NUT END OUTSIDE DIAMETER	DRIVE END OUTSIDE DIAMETER	NUT DEPTH	AVAILABLE	AVAILABLE	AVAILABLE	AVAILABLE	AVAILABLE
	ITEM	TYPE									
9 mm	7409M	I	1-1/2"	5/8"	7/8"	1/2"	6	✓	•	•	•
10 mm	7410M	I	1-1/2"	5/8"	7/8"	1/2"	6	✓	•	•	•
11 mm	7411M	I	1-1/2"	11/16"	7/8"	1/2"	6	✓	•	•	•
12 mm	7412M	I	1-1/2"	13/16"	15/16"	1/2"	6	✓	•	•	•
13 mm	7413M	I	1-1/2"	13/16"	15/16"	1/2"	6	✓	•	•	•
14 mm	7414M	I	1-1/2"	7/8"	15/16"	1/2"	6	✓	•	•	•
15 mm	7415M	II	1-1/2"	7/8"	1"	1/2"	6	✓	•	•	•
16 mm	7416M	II	1-1/2"	1"	1"	1/2"	6	✓	•	•	•
17 mm	7417M	II	1-1/2"	1-1/8"	1-1/8"	1/2"	6	✓	•	•	•
18 mm	7418M	II	1-1/2"	1-1/8"	1-1/8"	1/2"	6	✓	•	•	•
19 mm	7419M	II	1-1/2"	1-3/16"	1-3/16"	1/2"	6	✓	•	•	•
20 mm	7420M	II	1-1/2"	1-5/16"	1-5/16"	1/2"	6	✓	•	•	•
21 mm	7421M	II	1-1/2"	1-5/16"	1-5/16"	1/2"	6	✓	•	•	•
22 mm	7422M	II	1-1/2"	1-5/16"	1-5/16"	1/2"	6	✓	•	•	•
23 mm	7423M	II	1-1/2"	1-3/8"	1-3/8"	1/2"	6	✓	•	•	•
24 mm	7424M	II	1-1/2"	1-3/8"	1-3/8"	1/2"	6	✓	•	•	•
25 mm	7425M	II	1-1/2"	1-7/16"	1-7/16"	1/2"	6	✓	•	•	•
26 mm	7426M	II	1-1/2"	1-1/2"	1-1/2"	1/2"	6	✓	•	•	•
27 mm	7427M	II	1-1/2"	1-1/2"	1-1/2"	5/8"	6	✓	•	•	•
28 mm	7428M	II	1-15/16"	1-5/8"	1-5/8"	5/8"	6	✓	•	•	•
29 mm	7429M	II	1-15/16"	1-5/8"	1-5/8"	5/8"	6	✓	•	•	•
30 mm	7430M	II	1-15/16"	1-5/8"	1-5/8"	5/8"	6	✓	•	•	•
32 mm	7432M	II	1-15/16"	1-11/16"	1-1/2"	15/16"	6	✓	•	•	•
33 mm	7433M	III	2"	1-7/8"	1-1/2"	15/16"	1	✓	•	•	•
34 mm	7434M	III	2"	1-7/8"	1-1/2"	15/16"	1	✓	•	•	•
36 mm	7436M	III	2"	1-7/8"	1-1/2"	15/16"	1	✓	•	•	•

## 1/2" DRIVE IMPACT SOCKETS

### 1/2" DRIVE SAE DEEP IMPACT SOCKETS 12 POINT



DEEP SOCKET

INCHES



CHROME-MOLYBDENUM

ZINC PHOSPHATE FINISH

URREA



TYPE I

TYPE II

TYPE III

INDIVIDUAL SOCKETS									
OPENING SIZE	ITEM	TYPE	LENGTH	NUT END OUTSIDE DIAMETER	DRIVE END OUTSIDE DIAMETER	NUT DEPTH	⊞	AVAILABLE	
3/8"	7312	I	3-1/4"	5/8"	13/16"	9/16"	6	✓	
7/16"	7314	I	3-1/4"	11/16"	13/16"	9/16"	6	✓	
1/2"	7316	I	3-1/4"	13/16"	13/16"	9/16"	6	✓	
9/16"	7318	I	3-1/4"	7/8"	15/16"	15/16"	6	✓	
5/8"	7320	II	3-1/4"	15/16"	15/16"	15/16"	6	✓	
11/16"	7322	II	3-1/4"	1"	1"	15/16"	6	✓	
3/4"	7324	II	3-1/4"	1-3/16"	1-3/16"	15/16"	6	✓	
13/16"	7326	II	3-1/4"	1-1/4"	1-1/4"	15/16"	6	✓	
7/8"	7328	II	3-1/4"	1-1/4"	1-1/4"	15/16"	6	✓	
15/16"	7330	II	3-1/2"	1-5/16"	1-5/16"	15/16"	6	✓	
1"	7332	II	3-1/2"	1-3/8"	1-3/8"	15/16"	6	✓	
1-1/16"	7334	II	3-1/2"	1-1/2"	1-1/2"	15/16"	1	✓	
1-1/8"	7336	III	3-1/2"	1-9/16"	1-1/2"	15/16"	1	✓	
1-3/16"	7338	III	3-3/16"	1-5/8"	1-1/2"	1-1/2"	1	✓	
1-1/4"	7340	III	3-3/16"	1-3/4"	1-1/2"	1-1/2"	1	✓	
1-5/16"	7342	III	3-3/16"	1-15/16"	1-1/2"	1-1/2"	1	✓	
1-3/8"	7344	III	3-3/16"	1-15/16"	1-1/2"	1-1/2"	1	✓	
1-1/2"	7348	III	3-3/16"	2-1/4"	1-1/2"	1-1/2"	1	✓	

### 1/2" DRIVE SAE DEEP IMPACT SOCKETS 6 POINT



DEEP SOCKET

INCHES



CHROME-MOLYBDENUM

ZINC PHOSPHATE FINISH

URREA

NEW



TYPE I

TYPE II

TYPE III

INDIVIDUAL SOCKETS										SOCKET SET	
OPENING SIZE	ITEM	TYPE	LENGTH	NUT END OUTSIDE DIAMETER	DRIVE END OUTSIDE DIAMETER	NUT DEPTH	⊞	AVAILABLE		ITEM	PIECES
3/8"	7312H	I	3-1/4"	5/8"	7/8"	9/16"	6	✓		7301C	11
7/16"	7314H	I	3-1/4"	11/16"	7/8"	9/16"	6	✓		73112	11
1/2"	7316H	I	3-1/4"	3/4"	1"	1-1/2"	6	✓			
9/16"	7318H	I	3-1/4"	7/8"	1"	1-1/2"	6	✓			
5/8"	7320H	II	3-1/4"	1"	1"	1-1/2"	6	✓			
11/16"	7322H	II	3-1/4"	1-1/16"	1-1/16"	1-1/2"	6	✓			
3/4"	7324H	II	3-1/4"	1-3/16"	1-3/16"	1-1/2"	6	✓			
13/16"		II	3-1/4"	1-3/16"	1-3/16"	1-1/2"	6	✓			
7/8"	7328H	II	3-1/4"	1-3/8"	1-3/8"	1-1/2"	6	✓			
15/16"	7330H	II	3-1/4"	1-3/8"	1-3/8"	1-1/2"	6	✓			
1"	7332H	II	3-1/4"	1-1/2"	1-1/2"	1-1/2"	6	✓			
1-1/16"	7334H	II	3-1/4"	1-1/2"	1-1/2"	1-1/2"	1	✓			
1-1/8"	7336H	III	3-1/4"	1-9/16"	1-1/2"	1-1/2"	1	✓			
1-1/4"	7340H	III	3-1/4"	1-3/4"	1-1/2"	1-1/2"	1	✓			

PACKING	1	1
⊞	1	1
AVAILABLE	✓	✓

# 04 IMPACT SOCKETS AND ACCESSORIES

## 1/2" DRIVE IMPACT SOCKETS

### 1/2" DRIVE METRIC DEEP IMPACT SOCKETS 12 POINT



SHORT SOCKET

METRIC



CHROME-MOLYBDENUM

ZINC PHOSPHATE FINISH

URREA



TYPE I



TYPE II



TYPE III

#### SOCKET SET



74203

ITEM  
PIECES

15

PACKING

INCLUDE SOCKET RAIL AND CLIPS



AVAILABLE

1

✓

•

•

•

•

•

•

•

•

•

•

•

•

•

•

•

•

•

•

•

•

•

•

•

•

•

•

•

•

•

•

•

•

•

•

•

•

•

•

•

•

•

•

•

•

•

•

•

•

•

•

•

•

•

•

•

•

#### INDIVIDUAL SOCKETS



OPENING SIZE	ITEM	TYPE	LENGTH	NUT END OUTSIDE DIAMETER	DRIVE END OUTSIDE DIAMETER	NUT DEPTH	AVAILABLE
10 mm	7310MT	I	3-1/4"	11/16"	15/16"	1/2"	✓
11 mm	7311MT	I	3-1/4"	3/4"	15/16"	1/2"	✓
12 mm	7312MT	I	3-1/4"	13/16"	15/16"	1/2"	✓
13 mm	7313MT	I	3-1/4"	13/16"	15/16"	1/2"	✓
14 mm	7314MT	I	3-1/4"	7/8"	15/16"	1/2"	✓
15 mm	7315MT	II	3-1/4"	15/16"	15/16"	1/2"	✓
16 mm	7316MT	II	3-1/4"	15/16"	15/16"	1/2"	✓
17 mm	7317MT	II	3-1/4"	1-1/16"	1-1/16"	1/2"	✓
18 mm	7318MT	II	3-1/4"	1-1/16"	1-1/16"	1/2"	✓
19 mm	7319MT	II	3-1/4"	1-3/16"	1-3/16"	1/2"	✓
20 mm	7320MT	II	3-1/4"	1-3/16"	1-3/16"	1/2"	✓
21 mm	7321MT	II	3-1/4"	1-3/16"	1-3/16"	1/2"	✓
22 mm	7322MT	II	3-1/4"	1-3/16"	1-3/16"	1/2"	✓
23 mm	7323MT	II	3-1/4"	1-5/16"	1-5/16"	1/2"	✓
24 mm	7324MT	II	3-1/4"	1-3/8"	1-3/8"	1/2"	✓
27 mm	7327MT	III	3-1/4"	1-9/16"	1-1/2"	1/2"	✓

**URREA**  
SUPERIOR QUALITY AFFORDABLE TOOLS

usa.urrea.com



## 1/2" DRIVE IMPACT SOCKETS

### 1/2" DRIVE METRIC DEEP IMPACT SOCKETS 6 POINT



DEEP SOCKET

METRIC



CHROME-MOLYBDENUM



URREA



NEW



TYPE I

TYPE II

TYPE III

#### SOCKET SETS

ITEM	74216	73214M	7302MC	73212M
PIECES	25	15	13	10
PACKING	INCLUDE SOCKET RAIL AND CLIPS	INCLUDE SOCKET RAIL AND CLIPS	INCLUDE SOCKET RAIL AND CLIPS	INCLUDE SOCKET RAIL AND CLIPS
AVAILABLE	✓	✓	✓	✓

OPENING SIZE	INDIVIDUAL SOCKETS			NUT END OUTSIDE DIAMETER	DRIVE END OUTSIDE DIAMETER	NUT DEPTH	AVAILABLE
	ITEM	TYPE	LENGTH				
8 mm	7308M	I	3-3/16"	9/16"	15/16"	1-1/2"	6 ✓
9 mm	7309M	I	3-3/16"	5/8"	15/16"	1-1/2"	6 ✓
10 mm	7310M	I	3-3/16"	11/16"	15/16"	1-1/2"	6 ✓
11 mm	7311M	I	3-3/16"	11/16"	15/16"	1-1/2"	6 ✓
12 mm	7312M	I	3-3/16"	13/16"	15/16"	1-1/2"	6 ✓
13 mm	7313M	I	3-3/16"	13/16"	15/16"	1-1/2"	6 ✓
14 mm	7314M	I	3-3/16"	7/8"	15/16"	1-1/2"	6 ✓
15 mm	7315M	II	3-3/16"	15/16"	15/16"	1-1/2"	6 ✓
16 mm	7316M	II	3-3/16"	1-1/16"	15/16"	1-1/2"	6 ✓
17 mm	7317M	II	3-3/16"	1-1/16"	1-1/16"	1-1/2"	6 ✓
18 mm	7318M	II	3-3/16"	1-1/8"	1-1/16"	1-1/2"	6 ✓
19 mm	7319M	II	3-3/16"	1-3/16"	1-3/16"	1-1/2"	6 ✓
20 mm	7320M	II	3-3/16"	1-3/16"	1-3/16"	1-1/2"	6 ✓
21 mm	7321M	II	3-3/16"	1-1/4"	1-3/16"	1-1/2"	6 ✓
22 mm	7322M	II	3-3/16"	1-1/4"	1-3/16"	1-1/2"	6 ✓
23 mm	7323M	II	3-3/16"	1-5/16"	1-1/4"	1-1/2"	6 ✓
24 mm	7324M	II	3-3/16"	1-7/16"	1-1/4"	1-1/2"	6 ✓
25 mm	7325M	II	3-3/16"	1-7/16"	1-7/16"	1-1/2"	6 ✓
26 mm	7326M	II	3-3/16"	1-1/2"	1-7/16"	1-1/2"	6 ✓
27 mm	7327M	II	3-3/16"	1-9/16"	1-1/2"	1-1/2"	6 ✓
28 mm	7328M	III	3-3/16"	1-9/16"	1-1/2"	1-1/2"	6 ✓
29 mm	7329M	III	3-3/16"	1-9/16"	1-1/2"	1-1/2"	6 ✓
30 mm	7330M	III	3-3/16"	1-3/4"	1-1/2"	1-1/2"	6 ✓
32 mm	7332M	III	3-3/16"	1-3/4"	1-1/2"	1-1/2"	6 ✓
34 mm	7334M	III	3-3/16"	1-15/16"	1-1/2"	1-1/2"	1 ✓
35 mm	7335M	III	3-3/16"	1-15/16"	1-1/2"	1-1/2"	1 ✓
36 mm	7336M	III	3-3/16"	1-15/16"	1-1/2"	1-1/2"	1 ✓

### 1/2" DRIVE SAE THIN-WALL DEEP IMPACT SOCKETS 6 POINT



DEEP SOCKET

INCHES



CHROME-MOLYBDENUM



URREA



TYPE I

TYPE II

TYPE III

- Reduced wall thickness helps improve access to fasteners in restricted areas.
- Through hole to be secured using a o-ring and retaining pin.

#### SOCKET SET

ITEM	73112D
PIECES	11
PACKING	INCLUDE SOCKET RAIL AND CLIPS
AVAILABLE	✓

OPENING SIZE	INDIVIDUAL SOCKETS			NUT END OUTSIDE DIAMETER	DRIVE END OUTSIDE DIAMETER	NUT DEPTH	AVAILABLE
	ITEM	TYPE	LENGTH				
1/2"	7316HD	I	3-1/4"	23/32"	15/16"	7/16"	6 ✓
9/16"	7318HD	I	3-1/4"	13/16"	15/16"	9/16"	6 ✓
5/8"	7320HD	I	3-1/4"	7/8"	15/16"	9/16"	6 ✓
11/16"	7322HD	II	3-1/4"	31/32"	1"	9/16"	6 ✓
3/4"	7324HD	II	3-1/4"	1-1/32"	1"	11/16"	6 ✓
13/16"	7326HD	III	3-1/4"	1-1/8"	1-1/16"	11/16"	6 ✓
7/8"	7328HD	III	3-1/2"	1-1/8"	1-1/16"	13/16"	6 ✓
15/16"	7330HD	III	3-1/2"	1-1/4"	1-1/8"	15/16"	6 ✓
1"	7332HD	III	3-1/2"	1-23/64"	1-3/16"	15/16"	6 ✓
1-1/16"	7334HD	III	3-1/2"	1-7/16"	1-1/4"	1-1/16"	1 ✓
1-1/8"	7336HD	III	3-1/2"	1-33/64"	1-3/8"	1-1/16"	1 ✓

# 04 IMPACT SOCKETS AND ACCESSORIES

## 1/2" DRIVE IMPACT SOCKETS

### 1/2" DRIVE METRIC THIN-WALL DEEP IMPACT SOCKETS 6 POINT

**HEAVY DUTY**
**DEEP SOCKET**
**METRIC**
**1/2"**
**6**
**THIN WALL SOCKET**
**CHROME-MOLYBDENUM**
**ZINC PHOSPHATE FINISH**



TYPE I

- Reduced wall thickness helps improve access to fasteners in restricted areas.
- Through hole to be secured using a o-ring and retaining pin.

INDIVIDUAL SOCKETS								
OPENING SIZE	ITEM	TYPE	LENGTH	NUT END OUTSIDE DIAMETER	DRIVE END OUTSIDE DIAMETER	NUT DEPTH		AVAILABLE
13 mm	7313MD	I	3-1/4"	47/64"	15/16"	7/16"	6	✓

### 1/2" DRIVE SAE IMPACT SOCKETS 8 POINT

**HEAVY DUTY**
**SHORT SOCKET**
**INCHES**
**1/2"**
**8**
**CHROME-MOLYBDENUM**
**ZINC PHOSPHATE FINISH**



TYPE II

INDIVIDUAL SOCKETS								
OPENING SIZE	ITEM	TYPE	LENGTH	NUT END OUTSIDE DIAMETER	DRIVE END OUTSIDE DIAMETER	NUT DEPTH		AVAILABLE
11/16"	7422S	II	1-1/2"	1-3/16"	1-3/16"	5/8"	1	On Request

### 1/2" DRIVE FEMALE TORX IMPACT SOCKET AND TORX BIT IMPACT SOCKET SET



**HEAVY DUTY**
**TORX®**
**1/2"**

**16**  
PIECES



Type	Sizes	Pieces
Sockets	E10, E11, E12, E14, E16, E18, E20, E22, E24	9
Bit sockets	T40, T45, T47, T50, T55, T60, T70	7

ITEM	PIECES		AVAILABLE
74ET17	16	1	On Request

### 1/2" DRIVE FEMALE TORX IMPACT SOCKET SET



**HEAVY DUTY**
**TORX®**
**1/2"**

**9**  
PIECES



Type	Sizes	Pieces
Socket	E10, E11, E12, E14, E16, E18, E20, E22, E24	9

ITEM	PIECES		AVAILABLE
74300	9	1	✓

### 1/2" DRIVE TORX BIT IMPACT SOCKET SET



**HEAVY DUTY**
**TORX®**
**1/2"**

**9**  
PIECES



Type	Sizes	Pieces
Bit sockets	T20, T25, T27, T30, T40, T45, T50, T55, T60	9

ITEM	PIECES		AVAILABLE
74400	9	1	On Request

## 1/2" DRIVE IMPACT SOCKETS

### 1/2" DRIVE TORX BIT IMPACT SOCKETS

URREA  
HEAVY DUTY IMPACT TOOLS



744130W



INDIVIDUAL SOCKETS



TIP SIZE	ITEM	TOTAL LENGTH	EXPOSED TIP LENGTH	BIT LENGTH	DRIVE END OUTSIDE DIAMETER	⊞	AVAILABLE
T25	744125W	3"	3/4"	2"	1"	6	✓
T30	744130W	3"	3/4"	2"	1"	6	✓
T40	744140W	3"	3/4"	2"	1"	6	✓
T45	744145W	3"	3/4"	2"	1"	6	✓
T50	744150W	3"	3/4"	2"	1"	6	✓
T55	744155W	3"	3/4"	2"	1"	6	✓
T60	744160W	3"	3/4"	2"	1"	6	✓

IMPACT SOCKETS AND ACCESSORIES

### 1/2" DRIVE SAE HEXAGONAL BIT IMPACT SOCKET SET

URREA  
HEAVY DUTY IMPACT TOOLS



6  
PIECES



Type	Sizes	Pieces
Hexagonal	3/16", 7/32", 1/4", 5/16", 3/8", 7/16"	6

ITEM	PIECES	⊞	AVAILABLE
74150	6	1	✓

### 1/2" DRIVE SAE HEXAGONAL BIT IMPACT SOCKETS

URREA  
HEAVY DUTY IMPACT TOOLS



7441-1/2



INDIVIDUAL SOCKETS



TIP SIZE	ITEM	TOTAL LENGTH	EXPOSED TIP LENGTH	BIT LENGTH	DRIVE END OUTSIDE DIAMETER	⊞	AVAILABLE
1/4"	7441-1/4	3"	3/4"	2"	1"	6	✓
5/16"	7441-5/16	3"	3/4"	2"	1"	6	✓
3/8"	7441-3/8	3"	3/4"	2"	1"	6	✓
1/2"	7441-1/2	3"	3/4"	2"	1"	6	✓
5/8"	7441-5/8	3"	3/4"	2"	1"	6	✓
3/4"	7441-3/4	3"	3/4"	2"	1"	6	✓

### 1/2" DRIVE METRIC HEXAGONAL BIT IMPACT SOCKET SET

URREA  
HEAVY DUTY IMPACT TOOLS



6  
PIECES



Type	Sizes	Pieces
Hexagonal	4 mm, 6 mm, 8 mm, 10 mm, 12 mm, 14 mm	6

ITEM	PIECES	⊞	AVAILABLE
74250	6	1	✓

### 1/2" DRIVE METRIC HEXAGONAL BIT IMPACT SOCKETS

URREA  
HEAVY DUTY IMPACT TOOLS



7441-10M



INDIVIDUAL SOCKETS



TIP SIZE	ITEM	TOTAL LENGTH	EXPOSED TIP LENGTH	BIT LENGTH	DRIVE END OUTSIDE DIAMETER	⊞	AVAILABLE
6 mm	7441-6M	3"	1"	2-1/8"	1"	6	✓
8 mm	7441-8M	3"	1"	2-1/8"	1"	6	✓
10 mm	7441-10M	3"	1"	2-1/8"	1"	6	✓
14 mm	7441-14M	3"	1"	2-1/8"	1"	6	✓
17 mm	7441-17M	3"	1"	2-1/8"	1"	6	✓

# 04 IMPACT SOCKETS AND ACCESSORIES

## 3/4" DRIVE IMPACT SOCKETS

### 3/4" DRIVE SAE IMPACT SOCKETS 6 POINT



SHORT SOCKET

INCHES



URREA



NEW



TYPE I



TYPE II



TYPE III

Release date to be announced.

#### SOCKET SET

	6	6
ITEM	7501C	750010
PIECES	10	10
PACKING		
AVAILABLE	✓	✓

OPENING SIZE	INDIVIDUAL SOCKETS			LENGTH	NUT END OUTSIDE DIAMETER	DRIVE END OUTSIDE DIAMETER	NUT DEPTH	AVAILABLE	SOCKET SET	
	ITEM	TYPE	TYPE						6	6
1/2"	7508	I	I	1-15/16"	1"	1-5/8"	11/16"	1	✓	
9/16"	7509	I	I	1-15/16"	1"	1-5/8"	11/16"	1	✓	
5/8"	7510	I	I	1-15/16"	1-1/16"	1-5/8"	11/16"	1	✓	
11/16"	7511	I	I	1-15/16"	1-1/8"	1-5/8"	11/16"	1	✓	
3/4"	7512	I	I	1-15/16"	1-1/4"	1-5/8"	11/16"	1	✓	•
13/16"	7513	I	I	1-15/16"	1-3/8"	1-5/8"	11/16"	1	✓	•
7/8"	7514	I	I	2"	1-1/2"	1-5/8"	3/4"	1	✓	•
15/16"	7515	II	II	2"	1-5/8"	1-5/8"	3/4"	1	✓	•
1"	7516	II	II	2"	1-5/8"	1-5/8"	3/4"	1	✓	•
1-1/16"	7517	II	II	2"	1-11/16"	1-5/8"	3/4"	1	✓	•
1-1/8"	7518	II	II	2-3/16"	1-3/4"	1-3/4"	7/8"	1	✓	•
1-3/16"	7519	III	III	2-3/16"	1-13/16"	1-3/4"	1-3/16"	1	✓	•
1-1/4"	7520	III	III	2-3/16"	2"	1-3/4"	1-3/16"	1	✓	•
1-5/16"	7521	III	III	2-3/16"	2"	1-3/4"	1-3/16"	1	✓	•
1-3/8"	7522	III	III	2-1/4"	2"	1-3/4"	1-3/16"	1	✓	
1-7/16"	7523	III	III	2-5/16"	2-1/4"	1-3/4"	1-3/16"	1	✓	
1-1/2"	7524	III	III	2-5/16"	2-3/8"	1-3/4"	1-3/16"	1	✓	
1-9/16"	7525	III	III	2-5/16"	2-3/8"	1-3/4"	1-3/8"	1	✓	
1-5/8"	7526	III	III	2-5/16"	2-3/8"	1-3/4"	1-3/8"	1	✓	
1-11/16"	7527	III	III	2-1/2"	2-1/2"	1-3/4"	1-3/8"	1	✓	
1-3/4"	7528	III	III	2-1/2"	2-1/2"	1-3/4"	1-3/8"	1	✓	
1-13/16"	7529	III	III	2-3/4"	2-3/4"	1-3/4"	1-9/16"	1	✓	
1-7/8"	7530	III	III	2-3/4"	2-3/4"	1-3/4"	1-9/16"	1	✓	
1-15/16"	7531	III	III	2-3/4"	2-3/4"	1-3/4"	1-9/16"	1	✓	
2"	7532	III	III	3"	2-3/4"	1-3/4"	1-13/16"	1	✓	
2-1/16"	7533	III	III	2-13/16"	2-15/16"	2-1/8"	1-3/8"	1	✓	
2-1/8"	7534	III	III	2-13/16"	3"	2-1/8"	1-3/8"	1	✓	
2-3/16"	7535	III	III	2-29/32"	3"	2-1/8"	1-13/32"	1	✓	
2-1/4"	7536	III	III	2-29/32"	3-1/8"	2-1/8"	1-13/32"	1	✓	
2-3/8"	7538	III	III	2-15/16"	3-5/16"	2-1/8"	1-13/32"	1	✓	

IMPACT SOCKETS AND ACCESSORIES

## 3/4" DRIVE IMPACT SOCKETS

### 3/4" DRIVE METRIC IMPACT SOCKETS 6 POINT



SHORT SOCKET

METRIC



URREA



NEW



TYPE I



TYPE II



TYPE III

IMPACT SOCKETS AND ACCESSORIES

Release date to be announced.

#### SOCKET SET

	6	6
ITEM	7501MC	750015
PIECES	15	15
PACKING		
AVAILABLE	1	1

OPENING SIZE	INDIVIDUAL SOCKETS			LENGTH	NUT END OUTSIDE DIAMETER	DRIVE END OUTSIDE DIAMETER	NUT DEPTH	AVAILABLE	SOCKET SET	
	ITEM	TYPE	TYPE						7501MC	750015
17 mm	7517M	I	I	1-15/16"	1-1/8"	1-5/8"	9/16"	1	✓	•
19 mm	7519M	I	I	1-15/16"	1-3/16"	1-5/8"	9/16"	1	✓	•
20 mm	7520M	I	I	1-15/16"	1-5/16"	1-5/8"	5/8"	1	✓	•
21 mm	7521M	I	I	1-15/16"	1-5/16"	1-5/8"	5/8"	1	✓	•
22 mm	7522M	I	I	2"	1-1/2"	1-5/8"	11/16"	1	✓	•
23 mm	7523M	II	II	2"	1-5/8"	1-5/8"	11/16"	1	✓	•
24 mm	7524M	II	II	2"	1-5/8"	1-5/8"	3/4"	1	✓	•
25 mm	7525M	II	II	2-1/16"	1-5/8"	1-5/8"	3/4"	1	✓	•
26 mm	7526M	II	II	2-1/16"	1-11/16"	1-11/16"	3/4"	1	✓	•
27 mm	7527M	II	II	2-1/16"	1-11/16"	1-11/16"	3/4"	1	✓	•
28 mm	7528M	II	II	2-3/16"	1-3/4"	1-3/4"	3/4"	1	✓	•
29 mm	7529M	II	II	2-3/16"	1-3/4"	1-3/4"	3/4"	1	✓	•
30 mm	7530M	III	III	2-3/16"	1-7/8"	1-3/4"	1-1/8"	1	✓	•
31 mm	7531M	III	III	2-3/16"	2"	1-3/4"	1-1/16"	1	✓	•
32 mm	7532M	III	III	2-3/16"	2"	1-3/4"	1-1/16"	1	✓	•
33 mm	7533M	III	III	2-3/16"	2"	1-3/4"	1-1/16"	1	✓	•
34 mm	7534M	III	III	2-3/16"	2-1/16"	1-3/4"	1-1/16"	1	✓	•
35 mm	7535M	III	III	2-1/4"	2-1/8"	1-3/4"	1-1/8"	1	✓	•
36 mm	7536M	III	III	2-5/16"	2-1/4"	1-3/4"	1-3/16"	1	✓	•
38 mm	7538M	III	III	2-1/4"	2-1/2"	1-3/4"	1-3/16"	1	✓	•
40 mm	7540M	III	III	2-5/8"	2-1/2"	1-3/4"	1-3/16"	1	✓	•
41 mm	7541M	III	III	2-7/8"	2-1/2"	1-3/4"	1-3/16"	1	✓	•
42 mm	7542M	III	III	2-7/8"	2-1/2"	1-3/4"	1-3/16"	1	✓	•
43 mm	7543M	III	III	2-7/8"	2-1/2"	1-3/4"	1-3/16"	1	✓	•
46 mm	7546M	III	III	3"	2-5/8"	1-3/4"	1-1/4"	1	✓	•
50 mm	7550M	III	III	3-1/4"	2-3/4"	2"	1-1/4"	1	✓	•

# 04 IMPACT SOCKETS AND ACCESSORIES

## 3/4" DRIVE IMPACT SOCKETS

### 3/4" DRIVE SAE DEEP IMPACT SOCKETS 6 POINT



URREA



NEW



Release date to be announced.

ITEM	SOCKET SET	
	6	6
7502C	750010L	
PIECES	10	10
PACKING		
AVAILABLE	1	1

OPENING SIZE	INDIVIDUAL SOCKETS			LENGTH	NUT END OUTSIDE DIAMETER	DRIVE END OUTSIDE DIAMETER	NUT DEPTH	AVAILABLE	SOCKET SET	
	6	I	II						III	6
1/2"	7508L	I		3"	15/16"	1-1/2"	13/16"	1	✓	
9/16"	7509L	I		3"	1"	1-1/2"	13/16"	1	✓	
5/8"	7510L	I		3"	1-1/8"	1-1/2"	13/16"	1	✓	
3/4"	7512L	I		3"	1-1/4"	1-1/2"	1-3/8"	1	✓	•
13/16"	7513L	I		3"	1-3/8"	1-1/2"	2-3/8"	1	✓	•
7/8"	7514L	II		3"	1-9/16"	1-9/16"	3-3/8"	1	✓	•
15/16"	7515L	II		3"	1-9/16"	1-9/16"	4-3/8"	1	✓	•
1"	7516L	II		3"	1-5/8"	1-5/8"	5-3/8"	1	✓	•
1-1/16"	7517L	II		3"	1-5/8"	1-5/8"	6-3/8"	1	✓	•
1-1/8"	7518L	II		3"	1-7/8"	1-7/8"	1-5/8"	1	✓	•
1-3/16"	7519L	II		3-1/4"	2"	2"	1-5/8"	1	✓	•
1-1/4"	7520L	II		3-1/4"	2"	2"	1-5/8"	1	✓	•
1-5/16"	7521L	II		3-1/4"	2"	2"	1-5/8"	1	✓	•
1-3/8"	7522L	II		3-1/4"	2"	2"	1-5/8"	1	✓	•
1-7/16"	7523L	II		3-1/4"	2-1/4"	2-1/4"	1-5/8"	1	✓	
1-1/2"	7524L	II		3-1/2"	2-1/4"	2-1/4"	1-3/16"	1	✓	
1-9/16"	7525L	II		3-1/2"	2-1/4"	2-1/4"	1-3/16"	1	✓	
1-5/8"	7526L	II		3-1/2"	2-5/16"	2-5/16"	1-3/16"	1	✓	
1-11/16"	7527L	III		3-1/2"	2-1/2"	1-3/4"	1-7/8"	1	✓	
1-3/4"	7528L	III		3-1/2"	2-1/2"	1-3/4"	1-7/8"	1	✓	
1-13/16"	7529L	III		3-1/2"	2-5/8"	1-3/4"	1-3/16"	1	✓	
1-7/8"	7530L	III		3-3/4"	2-11/16"	1-3/4"	1-3/16"	1	✓	
1-15/16"	7531L	III		3-3/4"	2-3/4"	1-3/4"	1-7/8"	1	✓	
2"	7532L	III		3-3/4"	2-3/4"	1-3/4"	1-7/8"	1	✓	

### 3/4" DRIVE SAE DEEP IMPACT SOCKETS 6 POINT



SURTEK



TYPE II

- Exceeds ASME B107.110 standards.
- Zinc phosphate finish.
- With through-hole and groove to use with an O-ring or for use with pin or ball-type accessories.

OPENING SIZE	INDIVIDUAL SOCKETS			LENGTH	NUT END OUTSIDE DIAMETER	DRIVE END OUTSIDE DIAMETER	NUT DEPTH	AVAILABLE	
	6	II							
15/16"	S7915HL	II		3"	1-9/16"	1-9/16"	3-3/8"	1	✓
1"	S7916HL	II		3"	1-9/16"	1-9/16"	4-3/8"	1	✓
1-1/16"	S7917HL	II		3"	1-5/8"	1-5/8"	5-3/8"	1	✓
1-1/8"	S7918HL	II		3"	1-5/8"	1-5/8"	6-3/8"	1	✓
1-1/4"	S7920HL	II		3"	2"	2"	1-5/8"	1	On Request
1-5/16"	S7921HL	II		3"	2"	2"	1-5/8"	1	✓
1-3/8"	S7922HL	II		3"	2"	2"	1-5/8"	1	✓
1-7/16"	S7923HL	II		3"	2-1/4"	2-1/4"	1-5/8"	1	✓
1-1/2"	S7924HL	II		3"	2-1/4"	2-1/4"	1-3/16"	1	✓

## 3/4" DRIVE IMPACT SOCKETS

### 3/4" DRIVE METRIC DEEP IMPACT SOCKETS 6 POINT



DEEP SOCKET

METRIC



URREA



TYPE I

TYPE II

#### SOCKET SET



ITEM 750011ML

PIECES 11

PACKING



AVAILABLE

1

OPENING SIZE	INDIVIDUAL SOCKETS			LENGTH	NUT END OUTSIDE DIAMETER	DRIVE END OUTSIDE DIAMETER	NUT DEPTH	AVAILABLE
	ITEM	TYPE	TYPE					
19 mm	7519ML	I	3"	1-1/4"	1-1/2"	1-7/16"	1	✓
20 mm	7520ML	I	3"	1-3/8"	1-1/2"	1-7/16"	1	✓
21 mm	7521ML	I	3"	1-3/8"	1-1/2"	1-7/16"	1	✓
22 mm	7522ML	II	3"	1-9/16"	1-9/16"	1-7/16"	1	✓
23 mm	7523ML	II	3"	1-9/16"	1-9/16"	1-7/16"	1	✓
24 mm	7524ML	II	3"	1-9/16"	1-9/16"	1-7/16"	1	✓
25 mm	7525ML	II	3"	1-5/8"	1-5/8"	1-7/16"	1	✓
26 mm	7526ML	II	3"	1-5/8"	1-5/8"	1-7/16"	1	✓
27 mm	7527ML	II	3"	1-7/8"	1-7/8"	1-5/8"	1	✓
30 mm	7530ML	II	3-1/4"	2"	2"	1-3/4"	1	✓
32 mm	7532ML	II	3-1/4"	2"	2"	1-11/16"	1	✓
33 mm	7533ML	II	3-1/4"	2"	2"	1-5/8"	1	✓
34 mm	7534ML	II	3-1/4"	2"	2"	1-5/8"	1	✓
35 mm	7535ML	II	3-1/4"	2"	2"	1-5/8"	1	✓
36 mm	7536ML	II	3-1/4"	2"	2"	1-5/8"	1	✓
37 mm	7537ML	II	3-1/4"	2"	2"	1-5/8"	1	✓
38 mm	7538ML	II	3-1/2"	2-1/4"	2-1/4"	1-5/8"	1	✓
41 mm	7541ML	III	3-1/2"	2-1/2"	2-1/2"	1-11/16"	1	✓
43 mm	7543ML	III	3-1/2"	2-1/2"	2-1/2"	1-11/16"	1	✓

### 3/4" DRIVE SAE THIN-WALL DEEP IMPACT SOCKETS 6 POINT



DEEP SOCKET

INCHES



URREA



TYPE I

TYPE II

TYPE III

#### SOCKET SET



ITEM 7500LD

PIECES 10

PACKING



AVAILABLE

1

- Reduced wall thickness helps improve access to fasteners in restricted areas.
- Through hole to be secured using a o-ring and retaining pin.

OPENING SIZE	INDIVIDUAL SOCKETS			LENGTH	NUT END OUTSIDE DIAMETER	DRIVE END OUTSIDE DIAMETER	NUT DEPTH	AVAILABLE
	ITEM	TYPE	TYPE					
3/4"	7512LD	I	3-1/2"	1-3/16"	1-1/2"	1-3/8"	1	✓
13/16"	7513LD	I	3-1/2"	1-5/16"	1-1/2"	1-3/8"	1	✓
7/8"	7514LD	I	3-1/2"	1-5/16"	1-1/2"	1-1/2"	1	✓
15/16"	7515LD	I	3-1/2"	1-3/8"	1-1/2"	1-7/16"	1	✓
1"	7516LD	II	3-1/2"	1-7/16"	1-7/16"	1-7/16"	1	✓
1-1/16"	7517LD	II	3-1/2"	1-1/2"	1-1/2"	1-1/2"	1	✓
1-1/8"	7518LD	II	3-1/2"	1-9/16"	1-9/16"	1-7/16"	1	✓
1-3/16"	7519LD	II	3-1/2"	1-11/16"	1-11/16"	1-7/16"	1	✓
1-1/4"	7520LD	III	3-1/2"	1-3/4"	1-11/16"	1-1/2"	1	✓
1-5/16"	7521LD	III	3-1/2"	1-13/16"	1-11/16"	1-5/8"	1	✓
1-3/8"	7522LD	III	3-1/2"	1-15/16"	1-11/16"	1-5/8"	1	✓
1-7/16"	7523LD	III	3-1/2"	2"	1-11/16"	1-5/8"	1	On Request
1-1/2"	7524LD	III	3-1/2"	2"	1-11/16"	1-5/8"	1	✓

# 04 IMPACT SOCKETS AND ACCESSORIES

## 3/4" DRIVE IMPACT SOCKETS

### 3/4" DRIVE SAE IMPACT SOCKETS 8 POINT



SHORT SOCKET

INCHES

3/4"



CHROME-MOLYBDENUM

ZINC PHOSPHATE FINISH

URREA



TYPE II

#### INDIVIDUAL SOCKETS

OPENING SIZE	ITEM	TYPE	LENGTH	NUT END OUTSIDE DIAMETER	DRIVE END OUTSIDE DIAMETER	NUT DEPTH	AVAILABLE
13/16"	7513S	II	2-1/16"	1-9/16"	1-9/16"	5/8"	On Request
1"	7516S	II	2-1/16"	1-15/16"	1-15/16"	5/8"	On Request
1-1/16"	7517S	II	2-1/16"	1-15/16"	1-15/16"	5/8"	On Request
1-1/8"	7518S	II	2-1/16"	2-1/4"	2-1/4"	13/16"	✓

### 3/4" DRIVE SAE HEXAGONAL BIT IMPACT SOCKETS



HEXAGONAL

INCHES

3/4"



CHROME-MOLYBDENUM

URREA



7590-1/2

#### INDIVIDUAL SOCKETS

TIP SIZE	ITEM	TOTAL LENGTH	EXPOSED TIP LENGTH	BIT LENGTH	DRIVE END OUTSIDE DIAMETER	AVAILABLE
9/16"	7590-1/2	4"	5/8"	2-11/16"	1-3/4"	✓
5/8"	7590-9/16	4"	5/8"	2-11/16"	1-3/4"	✓
5/8"	7590-5/8	4"	13/16"	2-11/16"	1-3/4"	✓
3/4"	7590-3/4	4"	13/16"	2-11/16"	1-3/4"	✓
7/8"	7590-7/8	4"	13/16"	2-11/16"	1-3/4"	✓
1"	7590-1	4"	13/16"	2-11/16"	1-3/4"	✓

#### SOCKET SET

ITEM	75150
PIECES	6
PACKING	
AVAILABLE	✓

### 3/4" DRIVE METRIC HEXAGONAL BIT IMPACT SOCKETS



HEXAGONAL

METRIC

3/4"



CHROME-MOLYBDENUM

URREA



759024M

#### INDIVIDUAL SOCKETS

TIP SIZE	ITEM	TOTAL LENGTH	EXPOSED TIP LENGTH	BIT LENGTH	DRIVE END OUTSIDE DIAMETER	AVAILABLE
12 mm	759012M	4"	15/16"	2-5/8"	1-3/4"	✓
14 mm	759014M	4"	15/16"	2-5/8"	1-3/4"	✓
17 mm	759017M	4"	15/16"	2-5/8"	1-3/4"	✓
19 mm	759019M	4"	15/16"	2-5/8"	1-3/4"	✓
22 mm	759022M	4"	15/16"	2-5/8"	1-3/4"	✓
24 mm	759024M	4"	15/16"	2-5/8"	1-3/4"	✓

#### SOCKET SET

ITEM	75250
PIECES	6
PACKING	
AVAILABLE	✓

IMPACT SOCKETS AND ACCESSORIES



## 1" DRIVE IMPACT SOCKETS

### 1" DRIVE SAE IMPACT SOCKETS 12 POINT



SHORT SOCKET

INCHES



CHROME-MOLYBDENUM

ZINC PHOSPHATE FINISH

URREA



TYPE II

TYPE III

INDIVIDUAL SOCKETS										BULK
OPENING SIZE	ITEM	TYPE	LENGTH	NUT END OUTSIDE DIAMETER	DRIVE END OUTSIDE DIAMETER	NUT DEPTH		AVAILABLE		
1-3/8"	10022T	II	2-13/16"	2-1/4"	2-1/4"	1"	1	✓		
1-9/16"	10025T	II	2-7/8"	2-1/2"	2-1/2"	1-5/8"	1	✓		
2-1/16"	10033T	III	3-1/2"	2-3/8"	2-3/8"	2-1/8"	1	✓		
2-1/8"	10034T	III	3-1/2"	2-3/8"	2-3/8"	2-1/8"	1	✓		

## IMPACT SOCKET SETS IN METAL CASE WITH EVA FOAM TRAY.

### METAL CASE AND INNER TRAY

Easy to store and transport.



<p><b>12</b> 7301C PIECES STANDARD</p>	<p><b>14</b> 7302MC PIECES METRIC</p>	<p><b>20</b> 7401C PIECES STANDARD</p>
<p><b>16</b> 7401MC PIECES METRIC</p>	<p><b>16</b> 7402C PIECES STANDARD</p>	<p><b>25</b> 7402MC PIECES METRIC</p>
<p><b>11</b> 7501C PIECES STANDARD</p>	<p><b>16</b> 7501MC PIECES METRIC</p>	<p><b>10</b> 7502C PIECES STANDARD</p>



#### ENGRAVED SIZES

EVA foam tray with engraved size markings for easy identification.



#### DUAL-COLOR TRAY

Helps identify missing or misplaced tools.

# 04 IMPACT SOCKETS AND ACCESSORIES

## 1" DRIVE IMPACT SOCKETS

### 1" DRIVE SAE IMPACT SOCKETS 6 POINT



SHORT SOCKET

INCHES



URREA



TYPE I



TYPE II



TYPE III

ITEM		SOCKET SET	
PIECES	12		15101
PACKING			1
AVAILABLE	✓		



#### INDIVIDUAL SOCKETS



BULK

OPENING SIZE	ITEM	TYPE	LENGTH	NUT END OUTSIDE DIAMETER	DRIVE END OUTSIDE DIAMETER	NUT DEPTH	AVAILABLE
3/4"	10012	I	2-7/16"	2"	2"	3/4"	✓
13/16"	10013	I	2-7/16"	2"	2"	3/4"	✓
7/8"	10014	I	2-7/16"	2"	2"	9/16"	✓
15/16"	10015	I	2-1/2"	2"	2"	11/16"	✓
1"	10016	I	2-1/2"	2"	2"	11/16"	✓
1-1/16"	10017	I	2-1/2"	2"	2"	3/4"	✓
1-1/8"	10018	I	2-1/2"	2"	2"	3/4"	✓
1-3/16"	10019	I	2-11/16"	2"	2"	1-1/16"	✓
1-1/4"	10020	I	2-11/16"	2"	2"	7/8"	✓
1-5/16"	10021	I	2-13/16"	2-1/4"	2"	7/8"	✓
1-3/8"	10022	I	2-13/16"	2-1/4"	2-1/4"	15/16"	✓
1-7/16"	10023	I	2-13/16"	2-1/4"	2-1/4"	15/16"	✓
1-1/2"	10024	II	2-13/16"	2-5/16"	2-5/16"	1-5/8"	✓
1-9/16"	10025	II	2-7/8"	2-5/16"	2-5/16"	1-3/4"	✓
1-5/8"	10026	II	2-7/8"	2-1/2"	2-5/16"	1-3/4"	✓
1-11/16"	10027	II	3-1/8"	2-1/2"	2-1/2"	1-3/4"	✓
1-3/4"	10028	II	3-1/8"	2-1/2"	2-1/2"	1-7/8"	✓
1-13/16"	10029	II	3-1/8"	2-11/16"	2-5/8"	1-5/8"	✓
1-7/8"	10030	II	3-1/8"	2-11/16"	2-11/16"	1-9/16"	✓
1-15/16"	10031	II	3-3/16"	2-13/16"	2-13/16"	1-9/16"	✓
2"	10032	II	3-1/4"	2-7/8"	2-15/16"	1-9/16"	✓
2-1/16"	10033	III	2-3/4"	2-15/16"	2-1/4"	1-1/4"	✓
2-1/8"	10034	III	2-3/4"	3-1/16"	2-1/4"	1-1/4"	✓
2-3/16"	10035	III	2-13/16"	3-1/8"	2-1/4"	1-1/4"	✓
2-1/4"	10036	III	2-15/16"	3-5/16"	2-7/16"	1-3/8"	✓
2-5/16"	10037	III	2-15/16"	3-3/8"	2-1/4"	1-3/8"	✓
2-3/8"	10038	III	3-1/16"	3-7/16"	2-1/4"	1-3/8"	✓
2-7/16"	10039	III	3-1/16"	3-1/2"	2-1/4"	1-3/8"	✓
2-1/2"	10040	III	3-1/8"	3-9/16"	2-1/4"	1-7/16"	✓
2-9/16"	10041	III	3-1/8"	3-5/8"	2-1/4"	1-7/16"	✓
2-5/8"	10042	III	3-1/4"	3-3/4"	2-1/4"	1-1/2"	✓
2-11/16"	10043	III	3-1/4"	3-13/16"	2-1/4"	1-1/2"	✓
2-3/4"	10044	III	3-5/16"	3-7/8"	2-1/4"	1-9/16"	✓
2-13/16"	10045	III	3-5/16"	3-15/16"	2-1/4"	1-5/8"	✓
2-7/8"	10046	III	3-7/16"	4-1/16"	2-1/4"	1-5/8"	✓
2-15/16"	10047	III	3-3/4"	4-1/8"	3-3/8"	1-15/16"	✓
3"	10048	III	3-7/8"	4-1/16"	3-3/8"	2-1/16"	✓
3-1/8"	10050	III	4"	4-1/4"	3-3/8"	2"	✓
3-1/4"	10052	III	4-1/4"	4-1/2"	3-3/8"	2-3/8"	✓
3-3/8"	10054	III	4-7/16"	4-9/16"	3-3/8"	2-3/8"	✓
3-1/2"	10056	III	4-1/2"	4-3/4"	3-3/8"	2-1/2"	✓
3-5/8"	10058	III	4-3/4"	4-7/8"	3-3/8"	2-1/2"	✓
3-7/8"	10062	III	5"	5-1/16"	3-3/8"	2-1/2"	✓
4"	10064	III	5-1/2"	5-3/4"	3-3/8"	2-1/2"	✓
4-1/8"	10066	III	5-1/2"	6"	3-3/8"	2-3/4"	✓
4-1/4"	10068	III	5-1/2"	6"	3-3/8"	2-3/4"	✓
4-1/2"	10072	III	4"	6-1/4"	3-3/8"	3"	✓

IMPACT SOCKETS AND ACCESSORIES

## 1" DRIVE IMPACT SOCKETS

### 1" DRIVE METRIC DEEP IMPACT SOCKET 6 POINT



SHORT SOCKET

METRIC



URREA



TYPE I



TYPE II



TYPE III

#### SOCKET SET

ITEM	6
PIECES	15201
PACKING	12
PACKING	
AVAILABLE	1

IMPACT SOCKETS AND ACCESSORIES

OPENING SIZE	INDIVIDUAL SOCKETS			NUT END OUTSIDE DIAMETER	DRIVE END OUTSIDE DIAMETER	NUT DEPTH	BULK	AVAILABLE
	ITEM	TYPE	LENGTH					
24 mm	10024M	I	2-1/2"	2"	2"	21/32"	1	✓
27 mm	10027M	I	2-1/2"	2"	2"	55/64"	1	✓
30 mm	10030M	I	2-13/16"	2"	2"	1-1/8"	1	✓
32 mm	10032M	I	2-13/16"	2-1/4"	2"	1-1/8"	1	✓
33 mm	10033M	I	2-13/16"	2-1/4"	2"	31/32"	1	✓
36 mm	10036M	I	2-13/16"	2-1/4"	2-9/16"	31/32"	1	✓
41 mm	10041M	II	2-15/16"	2-5/16"	2-5/16"	1-1/4"	1	✓
46 mm	10046M	II	3-1/8"	2-5/8"	2-5/8"	1-1/4"	1	✓
50 mm	10050M	II	3-1/4"	2-15/16"	2-13/16"	1-1/4"	1	✓
55 mm	10055M	III	3-1/4"	3-1/8"	2-7/16"	1-7/16"	1	✓
60 mm	10060M	III	3-1/4"	3-7/16"	2-7/16"	1-7/16"	1	✓
65 mm	10065M	III	3-1/4"	3-11/16"	2-7/16"	1-7/16"	1	✓

### 1" DRIVE SAE DEEP IMPACT SOCKETS 6 POINT



DEEP SOCKET

INCHES



URREA



TYPE I



TYPE II



TYPE III

#### SOCKET SET

ITEM	6
PIECES	10000L
PACKING	12
PACKING	
AVAILABLE	1

OPENING SIZE	INDIVIDUAL SOCKETS			NUT END OUTSIDE DIAMETER	DRIVE END OUTSIDE DIAMETER	NUT DEPTH	BULK	AVAILABLE
	ITEM	TYPE	LENGTH					
7/8"	10014L	I	3-1/8"	1-9/16"	2"	1-1/16"	1	✓
15/16"	10015L	I	3-1/8"	1-5/8"	2"	1-1/16"	1	✓
1"	10016L	I	3-1/8"	1-3/4"	2"	1-1/16"	1	✓
1-1/16"	10017L	I	3-1/8"	1-11/16"	2"	1-1/16"	1	✓
1-1/8"	10018L	I	3-1/8"	1-13/16"	2"	1-1/16"	1	✓
1-3/16"	10019L	I	3-1/8"	1-13/16"	2"	1-1/16"	1	✓
1-1/4"	10020L	I	3-1/8"	2"	2"	1-1/16"	1	✓
1-5/16"	10021L	II	3-7/16"	2-1/4"	2-1/4"	1-5/8"	1	✓
1-3/8"	10022L	II	3-7/16"	2-1/4"	2-1/4"	1-1/2"	1	✓
1-7/16"	10023L	II	3-7/16"	2-1/4"	2-1/4"	1-1/16"	1	✓
1-1/2"	10024L	II	3-1/2"	2-5/16"	2-5/16"	1-11/16"	1	✓
1-9/16"	10025L	II	3-1/2"	2-5/16"	2-5/16"	1-11/16"	1	✓
1-5/8"	10026L	II	3-1/2"	2-5/16"	2-5/16"	1-11/16"	1	✓
1-11/16"	10027L	II	3-1/2"	2-5/8"	2-5/8"	1-11/16"	1	✓
1-3/4"	10028L	II	3-1/2"	2-5/8"	2-5/8"	1-11/16"	1	✓
1-13/16"	10029L	II	3-5/8"	2-11/16"	2-11/16"	1-5/8"	1	✓
1-7/8"	10030L	II	3-5/8"	2-11/16"	2-11/16"	1-5/8"	1	✓
1-15/16"	10031L	II	3-5/8"	2-13/16"	2-13/16"	1-1/2"	1	✓
2"	10032L	II	3-3/4"	2-15/16"	2-15/16"	1-5/8"	1	✓
2-1/8"	10034L	III	2-3/4"	3-1/16"	2-1/4"	2-1/4"	1	✓
2-3/16"	10035L	III	3-15/16"	3-1/16"	2-1/4"	2-1/4"	1	✓
2-1/4"	10036L	III	3-15/16"	3-5/16"	2-7/16"	2-7/16"	1	✓
2-5/16"	10037L	III	4-1/8"	3-3/8"	2-7/16"	2-7/16"	1	✓
2-3/8"	10038L	III	4-1/8"	3-7/16"	2-7/16"	2-7/16"	1	✓
2-9/16"	10041L	III	4-3/4"	3-5/8"	2-7/16"	3"	1	✓
2-3/4"	10044L	III	4-7/8"	3-7/8"	2-7/16"	3"	1	✓

# 04 IMPACT SOCKETS AND ACCESSORIES

## 1-1/2" DRIVE IMPACT SOCKETS

### 1-1/2" DRIVE SAE IMPACT SOCKETS 6 POINT



SHORT SOCKET

INCHES

1 1/2"

6



CHROME-MOLYBDENUM



ZINC PHOSPHATE FINISH

URREA



TYPE I



TYPE II



TYPE III

IMPACT SOCKETS AND ACCESSORIES



#### INDIVIDUAL SOCKETS



BULK

OPENING SIZE	ITEM	TYPE	LENGTH	NUT END OUTSIDE DIAMETER	DRIVE END OUTSIDE DIAMETER	NUT DEPTH	⊕	AVAILABLE
1-3/8"	15022	I	2-15/16"	2-3/8"	3-7/16"	3/4"	1	✓
1-7/16"	15023	I	3-1/8"	2-1/2"	3-7/16"	3/4"	1	✓
1-1/2"	15024	I	3-1/8"	2-1/2"	3-7/16"	7/8"	1	✓
1-5/8"	15026	I	3-1/8"	2-3/4"	3-7/16"	7/8"	1	✓
1-11/16"	15027	I	3-1/8"	2-15/16"	3-7/16"	1"	1	✓
1-13/16"	15029	I	3-1/8"	2-15/16"	3-7/16"	1"	1	✓
1-7/8"	15030	I	3-3/16"	3-1/8"	3-7/16"	1-1/16"	1	✓
2"	15032	I	3-3/16"	3-1/8"	3-7/16"	1-1/16"	1	✓
2-1/16"	15033	I	3-1/2"	3-3/8"	3-7/16"	1-1/8"	1	✓
2-1/8"	15034	II	3-1/2"	3-7/16"	3-7/16"	1-1/8"	1	✓
2-3/16"	15035	II	3-5/8"	3-7/16"	3-7/16"	1-1/4"	1	✓
2-1/4"	15036	II	3-5/8"	3-7/16"	3-7/16"	1-5/16"	1	✓
2-3/8"	15038	III	3-3/4"	3-5/8"	3-7/16"	1-3/8"	1	✓
2-7/16"	15039	III	3-3/4"	3-13/16"	3-7/16"	1-3/8"	1	✓
2-1/2"	15040	III	3-3/4"	4"	3-7/16"	1-3/8"	1	✓
2-9/16"	15041	III	3-3/4"	4"	3-7/16"	1-3/8"	1	✓
2-5/8"	15042	III	4"	4"	3-7/16"	1-1/2"	1	✓
2-3/4"	15044	III	4"	4"	3-7/16"	1-1/2"	1	✓
2-7/8"	15046	III	4-1/16"	4-1/4"	3-7/16"	1-13/16"	1	✓
2-15/16"	15047	III	4-1/16"	4-5/16"	3-7/16"	1-13/16"	1	✓
3"	15048	III	4-1/16"	4-5/16"	3-7/16"	1-13/16"	1	✓
3-1/8"	15050	III	4-5/16"	4-9/16"	3-7/16"	2"	1	✓
3-3/8"	15054	III	4-5/16"	4-15/16"	3-7/16"	2-1/16"	1	✓
3-1/2"	15056	III	4-5/16"	5-1/8"	3-7/16"	2-1/16"	1	✓
3-5/8"	15058	III	5-11/16"	5-1/8"	3-7/16"	2-1/16"	1	✓
3-3/4"	15060	III	5-11/16"	5-3/8"	3-3/4"	2-1/16"	1	✓
3-7/8"	15062	III	5-15/16"	5-1/2"	3-3/4"	2-5/16"	1	✓
4"	15064	III	5-15/16"	5-1/2"	3-3/4"	2-5/16"	1	✓
4-1/8"	15066	III	6-1/8"	5-15/16"	3-3/4"	2-5/16"	1	✓
4-1/4"	15068	III	6-15/16"	5-15/16"	3-3/4"	2-5/16"	1	✓
4-1/2"	15072	III	6-1/2"	6-5/16"	3-3/4"	2-5/8"	1	✓
4-5/8"	15074	III	6-11/16"	6-1/2"	3-3/4"	2-5/8"	1	✓
5"	15080	III	6-7/8"	7-1/16"	5"	2-13/16"	1	✓

URREA

SUPERIOR QUALITY AFFORDABLE TOOLS

usa.urrea.com



## 2-1/2" DRIVE IMPACT SOCKETS

### 2-1/2" DRIVE SAE IMPACT SOCKETS 6 POINT



SHORT SOCKET

INCHES

2 1/2"

6

CHROME-MOLYBDENUM

ZINC PHOSPHATE FINISH

URREA



TYPE I



TYPE II



TYPE III

IMPACT SOCKETS AND ACCESSORIES

INDIVIDUAL SOCKETS										BULK
OPENING SIZE	ITEM	TYPE	LENGTH	NUT END OUTSIDE DIAMETER	DRIVE END OUTSIDE DIAMETER	NUT DEPTH	⊞	AVAILABLE		
2"	25032	I	4-3/4"	3-7/16"	5"	1-1/4"	1	✓		
2-1/8"	25034	I	4-3/4"	3-9/16"	5"	1-1/4"	1	✓		
2-1/4"	25036	I	4-15/16"	3-1/4"	5"	1-3/8"	1	✓		
2-3/8"	25038	I	5-15/16"	3-7/8"	5"	1-7/16"	1	✓		
2-3/4"	25044	II	57/64"	4-5/16"	5"	1-9/16"	1	✓		
3"	25048	III	5-1/2"	4-23/32"	5"	1-7/8"	1	✓		
3-1/8"	25050	III	5-1/2"	4-7/8"	5"	2-3/32"	1	✓		
3-1/4"	25052	III	5-1/2"	5"	5"	2-3/32"	1	✓		
3-5/8"	25058	III	5-11/16"	5-1/2"	5"	2-3/16"	1	✓		
3-3/4"	25060	III	5-11/16"	5-5/8"	5"	2-3/16"	1	✓		
3-7/8"	25062	III	5-29/32"	5-25/32"	5"	2-5/16"	1	✓		
4"	25064	III	5-29/32"	5-15/16"	5"	2-5/16"	1	✓		
4-1/8"	25066	III	6-3/32"	6-1/8"	5"	2-1/2"	1	✓		
4-3/8"	25070	III	6-1/2"	6-7/16"	5"	2-11/16"	1	✓		
4-1/2"	25072	III	6-1/2"	6-9/16"	5"	2-11/16"	1	✓		
4-5/8"	25074	III	6-11/16"	6-3/4"	5"	2-7/8"	1	✓		
4-3/4"	25076	III	6-11/16"	6-15/16"	5"	2-7/8"	1	✓		
4-7/8"	25078	III	6-7/8"	7-1/8"	5"	3-1/32"	1	✓		
5"	25080	III	6-7/8"	7-1/4"	5"	3-1/32"	1	✓		

## DRIVE IMPACT ADAPTERS

### DRIVE IMPACT ADAPTERS



ZINC PHOSPHATE FINISH

URREA



• Spring-loaded pin drive.



• Spring-loaded ball drive.

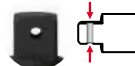

• Through-hole drive, o-ring and pin needed.



7651



7652



- Made of chrome molybdenum steel.
- Zinc phosphate finish.
- Exceeds ASME B107.110, DIN 3124, FEDERAL GGG-W-660, ISO 1174, and ISO 2725 standards.



ITEM	DESCRIPTION	TOTAL LENGTH (A)	MALE DRIVE	⊞	AVAILABLE	ITEM	DESCRIPTION	TOTAL LENGTH (A)	MALE DRIVE	⊞	AVAILABLE
<b>1/4" Drive</b>											
7648	Spring-loaded pin drive	1"	3/8"	6	✓	<b>3/4" Drive</b>					
<b>3/8" Drive</b>											
7650	Spring-loaded pin drive	1-7/16"	1/2"	6	✓	7655	Through-hole drive	2-1/2"	1"	1	✓
<b>1/2" Drive</b>											
7651	Spring-loaded pin drive	1-1/2"	3/8"	6	✓	7655B	Spring-loaded ball drive	2-1/2"	1"	1	✓
7652	Through-hole drive	1-7/8"	3/4"	6	✓	7653	Spring-loaded pin drive	2-3/16"	1/2"	1	✓
7652B	Spring-loaded ball drive	1-7/8"	3/4"	1	✓	<b>1" Drive</b>					
<b>1-1/2" Drive</b>											
10004	Through-hole drive	3-1/2"	1"	1	✓	7656	Through-hole drive	2-15/16"	3/4"	1	✓
10004B	Spring-loaded ball drive	3-1/2"	1"	1	✓	7656B	Spring-loaded ball drive	2-15/16"	3/4"	1	✓

# 04 IMPACT SOCKETS AND ACCESSORIES

## DRIVE IMPACT ADAPTERS

### INSERT BIT HOLDERS



- Female square drive to female hexagonal drive.
- Ideal for repetitive assembly operations using a torque controlled power tool.

ITEM	HEX NUT END	SPRING-LOADED PIN DRIVE	TOTAL LENGTH (A)	⊞	AVAILABLE
<b>1/4" Drive</b>					
<b>6971</b>	1/4"	x	7/8"	1	✓
<b>3/8" Drive</b>					
<b>7271</b>	1/4"	x	1-1/4"	1	✓
<b>7272</b>	5/16"	✓	1-1/2"	1	✓
<b>1/2" Drive</b>					
<b>7472</b>	5/16"	✓	1-1/2"	1	✓

## IMPACT EXTENSIONS

### IMPACT EXTENSIONS



- Through-hole drive, o-ring and pin needed.



**10607**      **10609**

- Made of chrome molybdenum steel.
- Zinc phosphate finish.
- Exceeds ASME B107.110, DIN 3124, FEDERAL GGG-W-660, ISO 1174, and ISO 2725 standards.

ITEM	DESCRIPTION	TOTAL LENGTH (A)	⊞	AVAILABLE
<b>1/4" Drive</b>				
<b>6962</b>	Spring-loaded pin drive	2"	6	✓
<b>6965</b>	Spring-loaded pin drive	6"	6	✓
<b>3/8" Drive</b>				
<b>7175P</b>	Spring-loaded pin drive	3"	6	✓
<b>7176P</b>	Spring-loaded pin drive	6"	6	✓
<b>1/2" Drive</b>				
<b>7180P</b>	Spring-loaded pin drive	2"	6	✓
<b>7181P</b>	Spring-loaded pin drive	5"	6	✓
<b>7184P</b>	Spring-loaded pin drive	9"	6	✓
<b>3/4" Drive</b>				
<b>7567</b>	* Through-hole drive	7-1/8"	1	✓

ITEM	DESCRIPTION	TOTAL LENGTH (A)	⊞	AVAILABLE
<b>1" Drive</b>				
<b>10607</b>	* Through-hole drive	7"	1	✓
<b>10607B</b>	* Spring-loaded ball drive	7"	1	✓
<b>10609</b>	* Through-hole drive	10"	1	✓
<b>10609B</b>	* Spring-loaded ball drive	10"	1	✓
<b>1-1/2" Drive</b>				
<b>15097</b>	* Spring-loaded pin drive	9"	1	✓



### IMPACT EXTENSIONS



- Spring-loaded ball drive.

- Exceeds ASME B107.110 standards.
- Black oxide finish.
- With a through-hole for use with pin or ball accessories.

ITEM	TOTAL LENGTH (A)	⊞	AVAILABLE
<b>1/2" Drive</b>			
<b>S7861</b>	5"	6	✓



IMPACT SOCKETS AND ACCESSORIES

## IMPACT HANDLES

### IMPACT HANDLES



10657

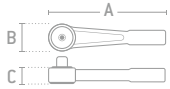

- It can be used with all types of 3/4" square drive sockets.
- Wide striking area.
- Electrostatic paint to prevent corrosion.
- I-type body design allows more resistance and torque.

ITEM	TOTAL LENGTH (A)	HEAD WIDTH (B)	HEAD DEPTH (C)	SPARE PART	📦	AVAILABLE
<b>3/4" Drive</b>						
<b>7657</b>	10-1/32"	2"	1-3/8"	✓	1	✓
<b>1" Drive</b>						
<b>10657</b>	11-15/16"	2-1/8"	1-3/16"	✓	1	✓

### IMPACT HANDLE SPARE KITS



7657RK

10657RK

ITEM	FOR MODEL	📦	AVAILABLE
<b>7657RK</b>	For 7657	1	✓
<b>10657RK</b>	For 10657	1	✓



VIDEO

**BULK**

IMPACT SOCKETS AND ACCESSORIES

## L-IMPACT HANDLES

### L-IMPACT HANDLES



- Spring-loaded ball drive.
- Through-hole drive, o-ring and pin needed.



5686B



15686

- Made of chrome molybdenum steel.
- Zinc phosphate finish.
- Exceeds ASME B107.110, DIN 3124, FEDERAL GGG-W-660, ISO 1174, and ISO 2725 standards.

ITEM	DESCRIPTION	TOTAL LENGTH (A)	📦	AVAILABLE
<b>3/4" Drive</b>				
<b>5686B</b>	Spring-loaded ball drive	16"	1	✓
<b>1" Drive</b>				
<b>5886B</b>	Spring-loaded ball drive	30"	1	✓
<b>1-1/2" Drive</b>				
<b>15686</b>	Through-hole	38"	1	✓

## IMPACT UNIVERSAL JOINTS

### IMPACT UNIVERSAL JOINTS



- Spring-loaded pin drive.
- Spring-loaded ball drive.
- Through-hole drive, o-ring and pin needed.



7470P

- The impact universal joint allows you to use impact sockets in hard-to-reach areas, even letting you work at an angle up to 90°.
- This tool is the link between the impact socket and the impact extension, driven by pneumatic tool (or air tool).

ITEM	DESCRIPTION	TOTAL LENGTH (A)	📦	AVAILABLE	ITEM	DESCRIPTION	TOTAL LENGTH (A)	📦	AVAILABLE
<b>1/4" Drive</b>					<b>3/4" Drive</b>				
<b>6970</b>	Spring-loaded pin drive	1-11/16"	6	✓	<b>7570</b>	Through-hole drive	4-1/8"	1	✓
<b>3/8" Drive</b>					<b>7570B</b>	Spring-loaded metal ball drive	4-1/8"	1	✓
<b>7270P</b>	Spring-loaded pin drive	1-15/16"	6	✓	<b>1" Drive</b>				
<b>1/2" Drive</b>					<b>10670</b> *	Through-hole drive	5-1/4"	1	✓
<b>7470P</b>	Spring-loaded pin drive	2-3/8"	6	✓	<b>10670B</b> *	Spring-loaded metal ball drive	5-1/4"	1	✓
					<b>1-1/2" Drive</b>				
					<b>15670</b> *	Through-hole drive	5-1/4"	1	✓

\* **BULK**

## O-RINGS



7500R1

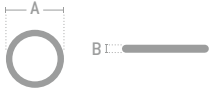

ITEM	DIAMETER (A)	THICKNESS (B)	☞	AVAILABLE
<b>3/4" Drive</b>				
7500R1	1-11/32"	9/64"	10	✓
<b>1" Drive</b>				
10000R1	1-21/32"	9/64"	10	✓
10000R2	1-3/4"	9/64"	10	✓
10000R3	1-15/16"	9/64"	10	✓
10000R4	1-31/32"	13/64"	10	✓
10000R5	2-3/32"	7/32"	10	✓
10000R6	2-31/32"	7/32"	10	✓
<b>1-1/2" Drive</b>				
15000R1	2-15/16"	7/32"	10	✓

## PINS



7500P1



ITEM	LENGTH (A)	DIAMETER (B)	☞	AVAILABLE
<b>3/4" Drive</b>				
7500P1	1-3/8"	13/64"	10	✓
<b>1" Drive</b>				
10000P1	1-23/32"	13/64"	10	✓
10000P2	1-15/16"	13/64"	10	✓
10000P3	2-15/16"	1/4"	10	✓
<b>1-1/2" Drive</b>				
15000P1	2-61/64"	5/16"	1	✓
<b>2-1/2" Drive</b>				
25000P1	4-31/64"	5/16"	1	On Request





CLASS	TYPE	PAGE	BRAND	
			URREA	SURTEK
Adjustable wrenches	Adjustable wrenches with rubber grip	184	•	•
	Chrome adjustable wrenches	185	•	•
	Black adjustable wrenches	186	•	
	Oxide finish adjustable wrenches	186		•
Combined wrenches	Full polish combination wrenches	187	•	•
	Satin combination wrenches	193	•	•
	Black combination wrenches	198	•	
	Flexible wrenches	199	•	
	Combination ratcheting wrenches	200	•	•
Open-end wrenches	Open end wrenches	206	•	•
	Offset ratcheting wrenches	208	•	•
Box-end wrenches	Obstruction spline wrenches	210	•	
	Ratcheting spline wrenches	211	•	
	Flare wrenches	214	•	
Specialty wrenches	Wrenches with pin	214	•	
	Service wrenches	215	•	
Industrial wrenches	High-Leverage Wrenches	216	•	
	Striking wrenches	219	•	
	Spud Wrenches	222	•	

[usa.urrea.com](http://usa.urrea.com)

We are constantly improving our products, that is why the information, characteristics and availability can change without prior notice.



## ADJUSTABLE WRENCHES

### CHROME ADJUSTABLE WRENCHES WITH RUBBER GRIP HANDLE

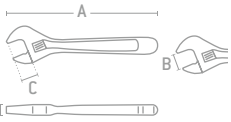

712G



\* BULK

		WRENCH SET	
ITEM	795G		
PIECES	3		
PACKING			
		1	
AVAILABLE	✓		

- Rounded corners in the opening avoid pressure concentration and provide a better fit to the fastener.
- The arrow indicates correct turning direction.
- Extra wide opening, allowing you to work on a wide range of nuts and bolts.
- Exceed ASME B107.100 standard.

ITEM	TOTAL LENGTH (A)	MAXIMUM OPENING (B)	JAW DEPTH (C)	JAW THICKNESS (D)	AVAILABLE
704G	4"	1/2"	1/2"	11/32"	✓
706G	6"	15/16"	3/4"	3/8"	✓
708G	8"	1"	1"	15/32"	✓
710G	10"	1-1/8"	1-1/8"	19/32"	•
712G	12"	1-5/16"	1-5/16"	23/32"	•
715G*	15"	1-11/16"	1-5/8"	15/16"	✓
718G*	18"	2-1/8"	1-15/16"	1-1/8"	✓
724G*	24"	2-7/16"	2-7/16"	1-1/4"	✓

### CHROME ADJUSTABLE WRENCHES WITH RUBBER GRIP HANDLE

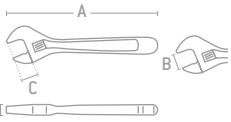

512P



506CA

Stubby bimaterial handle



- High-precision machining to ensure smooth operation and better jaw closure fit.
- Marked in inches and millimeters.
- Made of chrome vanadium steel.
- Nickel-chrome coating.
- Complies with ASME B107.8 standards.

ITEM	TOTAL LENGTH (A)	MAXIMUM OPENING (B)	JAW DEPTH (C)	JAW THICKNESS (D)	AVAILABLE
<b>Chrome adjustable wrenches with handle grip plastic</b>					
506P	6"	3/4"	2/3"	9/32"	6 On Request
508P	8"	1"	29/32"	5/16"	6 On Request
510P	10"	1-1/8"	1-1/8"	11/32"	6 On Request
512P	12"	1-5/16"	1-9/32"	7/16"	6 On Request
<b>Chrome adjustable stubby wrench with rubber grip handle</b>					
506CA	6"	1"	15/16"	3/4"	6 On Request

### WIDE OPENING ADJUSTABLE WRENCH WITH LOW PROFILE JAW



+50% WIDER OPENING

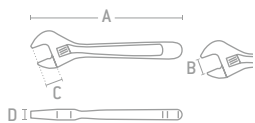

- Low profile jaw, 50% thinner than conventional wrenches. Ideal to work on reduced working areas.

ITEM	TOTAL LENGTH (A)	MAXIMUM OPENING (B)	JAW DEPTH (C)	HEAD THICKNESS (D)	AVAILABLE
708XS	8"	1-1/2"	1-5/16"	19/32"	1 ✓



usa.urrea.com

## CHROME ADJUSTABLE WRENCHES

### CHROME ADJUSTABLE WRENCHES

URREA

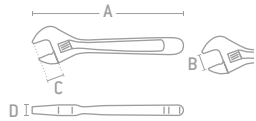

710

ITEM		WRENCH SET	
PIECES	795		3
PACKING			
		AVAILABLE	✓

- Nickel-chrome finish to prevent rust.
- Rounded corners in the opening avoid pressure concentration and provide a better fit to the fastener
- The arrow indicates the correct turning direction.
- Extra wide opening, allowing you to work on a wide range of nuts and bolts.
- Exceed ASME B107.100 standard.

ITEM	TOTAL LENGTH (A)	MAXIMUM OPENING (B)	JAW DEPTH (C)	JAW THICKNESS (D)	AVAILABLE
704	4"	1/2"	1/2"	11/32"	✓
706	6"	15/16"	3/4"	3/8"	✓
708	8"	1"	1"	15/32"	✓
710	10"	1-1/8"	1-1/8"	19/32"	•
712	12"	1-5/16"	1-5/16"	23/32"	•
715*	15"	1-11/16"	1-5/8"	15/16"	✓
718*	18"	2-1/8"	1-15/16"	1-1/8"	✓
724*	24"	2-7/16"	2-7/16"	1-1/4"	✓

### CHROME ADJUSTABLE WRENCHES



URREA

### CHROME ADJUSTABLE WRENCHES



SURTEK

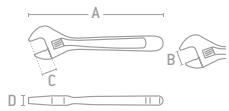

724I



NEW

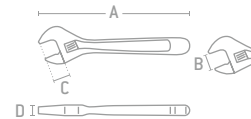

512

- Ergonomic handle and extra-capacity jaws to cover a wide range of bolts and nuts.
- High-precision machining to ensure smooth operation and better jaw closure fit.
- Chrome-nickel finish to prevent corrosion.
- Graduated jaws on both sides.
- Exceeds ASME B107.8 standards.

- High-precision machining to ensure smooth operation and better jaw closure fit.
- Chrome-nickel finish to prevent corrosion.
- Graduated jaws on both sides.
- Complies with ASME B107.10 standard.

ITEM	TOTAL LENGTH (A)	MAXIMUM OPENING (B)	JAW DEPTH (C)	JAW THICKNESS (D)	AVAILABLE
706I	6"	15/16"	3/4"	3/8"	On Request
708I	8"	1-11/64"	1"	15/32"	On Request
710I	10"	1-3/8"	1-1/8"	19/32"	On Request
712I	12"	1-39/64"	1-5/16"	23/32"	On Request
715I*	15"	1-49/64"	1-5/8"	15/16"	On Request
718I*	18"	2-5/32"	1-15/16"	1-1/8"	On Request
724I*	24"	2-35/64"	2-7/16"	1-1/4"	On Request

### CHROME ADJUSTABLE WRENCHES



URREA

URREA  
SUPERIOR QUALITY AFFORDABLE TOOLS

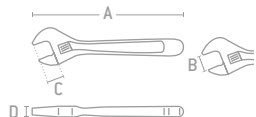

- Chrome vanadium steel construction.
- Handle is forged in one piece to ensure maximum strength.
- Greater jaw capacity supports larger nuts and bolts.
- Ideal for mining, gas & oil industry.

- Practical thumb screw for quick adjustment.

BULK

ITEM	TOTAL LENGTH (A)	MAXIMUM OPENING (B)	JAW DEPTH (C)	HEAD THICKNESS (D)	AVAILABLE
730	30"	3"	1-5/8"	1-1/4"	✓



## BLACK ADJUSTABLE WRENCHES

### BLACK ADJUSTABLE WRENCHES



710S

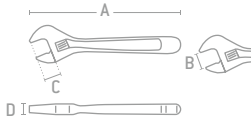

- Phosphatized finish ideal for industries where chrome particle shedding is critical.
- Rounded corners in the opening avoid pressure concentration and provide a better fit to the fastener.
- The arrow indicates the correct turning direction.
- Extra wide opening, allowing you to work on a wide range of nuts and bolts.
- Exceeds ASME B107.100 standard.



		WRENCH SET	
ITEM	795S		
PIECES	3		
PACKINS			
		1	✓

ITEM	TOTAL LENGTH (A)	MAXIMUM OPENING (B)	JAW DEPTH (C)	JAW THICKNESS (D)	✓	AVAILABLE
704S	4"	1/2"	33/64"	11/32"	1	✓
706S	6"	15/16"	3/4"	3/8"	1	✓
708S	8"	1"	1"	15/32"	1	✓
710S	10"	1-1/8"	1-1/8"	19/32"	1	✓
712S	12"	1-5/16"	1-5/16"	23/32"	1	✓
715S*	15"	1-11/16"	1-5/8"	15/16"	1	✓
718S*	18"	2-1/8"	1-15/16"	1-1/8"	1	✓
724S*	24"	2-7/16"	2-7/16"	1-1/4"	1	✓

### BLACK ADJUSTABLE WRENCHES



NEW



724SI

- High-precision machining to ensure smooth operation and better jaw closure fit.
- Made of chrome vanadium steel.
- Zinc phosphate finish.
- Exceeds ASME B107.8 standards.



ITEM	TOTAL LENGTH (A)	MAXIMUM OPENING (B)	JAW DEPTH (C)	JAW THICKNESS (D)	✓	AVAILABLE
706SI	6"	15/16"	3/4"	3/8"	1	On Request
708SI	8"	1-11/64"	1"	15/32"	1	On Request
710SI	10"	1-3/8"	1-1/8"	19/32"	1	On Request
712SI	12"	1-39/64"	1-5/16"	23/32"	1	On Request
715SI*	15"	1-49/64"	1-5/8"	15/16"	1	On Request
718SI*	18"	2-5/32"	1-15/16"	1-1/8"	1	On Request
724SI*	24"	2-35/64"	2-7/16"	1-1/4"	1	On Request

### OXIDE FINISH ADJUSTABLE WRENCHES



512S

- High-precision machining to ensure smooth operation and better jaw closure fit.
- Made of chrome vanadium steel.
- Black Oxide finish.
- Complies with ASME B107.8 standards.



ITEM	TOTAL LENGTH (A)	MAXIMUM OPENING (B)	JAW DEPTH (C)	JAW THICKNESS (D)	✓	AVAILABLE
506S	6"	3/4"	3/4"	1/2"	6	On Request
508S	8"	1"	15/16"	9/16"	6	On Request
510S	10"	1-1/8"	1-1/8"	2/3"	6	On Request
512S	12"	1-5/16"	1-3/8"	3/4"	6	On Request
515S	15"	1-13/16"	1-21/32"	29/32"	6	On Request
518S*	18"	2-1/4"	2"	2-1/4"	1	On Request
524S*	24"	2-3/4"	1"	1-1/16"	1	On Request

### BLACK STRUCTURAL ADJUSTABLE WRENCH

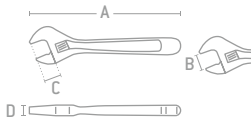

- Extra capacity that can be used on a wider range of nuts and bolts.
- Conical tip handle works as alignment bar when assembling structures.
- Phosphatized finish prevents corrosion.
- Long handle increases torsion capacity.
- Exceeds ASME B107.100 standard.

BULK

ITEM	TOTAL LENGTH (A)	MAXIMUM OPENING (B)	JAW DEPTH (C)	HEAD THICKNESS (D)	✓	AVAILABLE
712SC	16"	2-7/16"	1-7/16"	23/32"	1	✓

### CHROME PLATED WIDE OPENING ADJUSTABLE WRENCHES



706WO

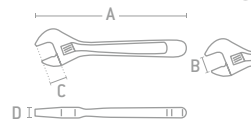

- High-precision machining to ensure smooth operation and better jaw closure fit.
- Made of chrome vanadium steel.
- Complies with ASME B107.8 standards.

BULK

ITEM	TOTAL LENGTH (A)	MAXIMUM OPENING (B)	JAW DEPTH (C)	HEAD THICKNESS (D)	✓	AVAILABLE
706WO	6"	1-1/8"	3/4"	9/32"	1	On Request
708WO	8"	1-5/16"	1"	5/16"	1	On Request
710WO	10"	1-1/2"	1-1/8"	3/8"	1	On Request

FULL POLISH COMBINATION WRENCHES



# FULL POLISH 12-POINT SHORT COMBINATION WRENCHES.

**SHORT WRENCHES**  
THIN AND COMPACT END.



STUBBY WRENCHES

CHROME VANADIUM

MIRROR FINISH

URREA GRIP SYSTEM UGS

SUPER DRIVE

Modern machines are more efficient, perform better and feature technological characteristics exceeding the imagination, but they are also more compact, providing less space when the time comes to repair or maintain them. To tackle this, Urrea presents its short combination wrench line.  
To keep your wrenches together and in order we recommend using the different organization and storage options presented in chapter 2 of this catalog.



Machined and heat-treated to exceed international standards.



12-point box-end with 15° angle for comfortable handling.

FULL POLISH SAE COMBINATION SHORT WRENCHES 12 POINT



STANDARD



STUBBY WRENCHES

SUPER DRIVE

URREA GRIP SYSTEM UGS

MIRROR FINISH



MECHANICAL WRENCHES

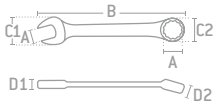

1210T

- Made of chrome vanadium steel.
- Exceeds ASME B107.100 standards.
- Heat-treated for high performance and corrosion resistance.
- Slim and compact head.
- 15° angle for more comfortable handling.



ITEM	OPENING SIZE (A)		TOTAL LENGTH (B)		OUTSIDE DIAMETER (C)		HEAD THICKNESS (D)		UGS	☑	AVAILABLE
	OPEN END (C1)	BOX END (C2)	OPEN END (D1)	BOX END (D2)							
1208T	1/4"	3"	39/64"	25/64"	9/64"	11/64"	×	6	✓	✓	
1210T	5/16"	3-1/4"	45/64"	15/32"	11/64"	13/64"	×	6	✓	✓	
1212T	3/8"	4-3/16"	51/64"	17/32"	3/16"	15/64"	✓	6	✓	•	
1214T	7/16"	5"	15/16"	5/8"	13/64"	1/4"	✓	6	✓	•	
1216T	1/2"	5-1/4"	1-3/32"	45/64"	7/32"	9/32"	✓	6	✓	•	
1218T	9/16"	5-3/4"	1-13/64"	53/64"	1/4"	5/16"	✓	6	✓	•	
1220T	5/8"	6-1/8"	1-21/64"	7/8"	17/64"	21/64"	✓	6	✓	•	
1222T	11/16"	6-1/2"	1-29/64"	61/64"	9/32"	11/32"	✓	6	✓	•	
1224T	3/4"	6-25/32"	1-37/64"	1-1/16"	19/64"	3/8"	✓	6	✓	•	

ITEM	WRENCH SETS		
	1201T6	1200T9	1200T6
PIECES	6	9	6
PACKING			
☑	1	1	1
AVAILABLE	✓	✓	✓

FULL POLISH METRIC COMBINATION SHORT WRENCHES 12 POINT



METRIC



STUBBY WRENCHES

SUPER DRIVE

URREA GRIP SYSTEM UGS

MIRROR FINISH

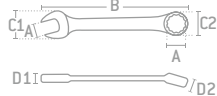

1219MT

- Made of chrome vanadium steel.
- Exceeds ASME B107.100 standards.
- Heat-treated for high performance and corrosion resistance.
- Slim and compact head.
- 15° angle for more comfortable handling.



ITEM	OPENING SIZE (A)		TOTAL LENGTH (B)		OUTSIDE DIAMETER (C)		HEAD THICKNESS (D)		UGS	☑	AVAILABLE
	OPEN END (C1)	BOX END (C2)	OPEN END (D1)	BOX END (D2)							
1207MT	7 mm	3"	19/32"	25/64"	9/64"	11/64"	-	6	✓	On Request	
1208MT	8 mm	3-1/4"	11/16"	15/32"	11/64"	13/64"	-	6	✓	•	
1209MT	9 mm	4-3/16"	13/16"	17/32"	11/64"	15/64"	✓	6	✓	•	
1210MT	10 mm	5"	15/16"	39/64"	13/64"	1/4"	✓	6	✓	•	
1211MT	11 mm	5"	15/16"	39/64"	13/64"	1/4"	✓	6	✓	•	
1212MT	12 mm	5-1/4"	1-3/32"	45/64"	7/32"	9/32"	✓	6	✓	•	
1213MT	13 mm	5-1/4"	1-3/32"	45/64"	7/32"	9/32"	✓	6	✓	•	
1214MT	14 mm	5-3/4"	1-3/16"	25/32"	15/64"	19/64"	✓	6	✓	•	
1215MT	15 mm	5-3/4"	1-3/16"	25/32"	15/64"	19/64"	✓	6	✓	•	
1216MT	16 mm	6-1/8"	1-5/16"	7/8"	17/64"	21/64"	✓	6	✓	•	
1217MT	17 mm	6-1/2"	1-5/16"	61/64"	17/64"	11/32"	✓	6	✓	•	
1218MT	18 mm	6-1/2"	1-5/16"	61/64"	17/64"	11/32"	✓	6	✓	•	
1219MT	19 mm	6-3/4"	1-9/16"	1"	9/32"	3/8"	✓	6	✓	•	

FULL POLISH SAE AND METRIC COMBINATION WRENCH SET 12 POINT



STANDARD



METRIC



SUPER DRIVE

URREA GRIP SYSTEM UGS

16 PIECE

Item	Opening size
1208	1/4"
1210	5/16"
1212	3/8"
1214	7/16"
1216	1/2"
1218	9/16"
1220	5/8"
1222	11/16"
1224	3/4"
1208M	8 mm
1210M	10 mm
1211M	11 mm
1212M	12 mm
1213M	13 mm
1214M	14 mm
1215M	15 mm
E553	Pouch



- Oval-shaped body for better grip.
- 15° angle for more comfortable handling.
- Made of chrome vanadium steel.
- Nickel-chrome plating.
- Exceeds ASME B107.100 standards

POUCH

ITEM	PIECES	☑	AVAILABLE
1200FC	16	1	✓

## FULL POLISH COMBINATION WRENCHES

# FULL POLISH 12 & 6-POINT COMBINATION WRENCHES.

## COMBINATION WRENCHES

Combination wrenches feature two same-size openings; the open-end allows you to quickly apply low torque and the box-end allows you to apply final and greater torque.



The opening angle allows two actionable positions, reducing the recovery angle to 15°.



Box-end  
• 30° recovery angle.  
• Oval handle for a more comfortable grip.



Open-end  
• Machined to precision openings.  
• 15° recovery angle.  
• Thin openings for better access in narrow areas.

- MIRROR FINISH
- SUPER DRIVE
- SUPER DRIVE
- URREA GRIP SYSTEM UGS

MECHANICAL WRENCHES

## FULL POLISH SAE COMBINATION WRENCHES 6 AND 12 POINT



STANDARD



URREA



NEW

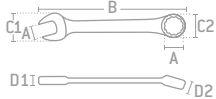

- Made of chrome vanadium steel
- Exceeds ASME B107.100 standards
- Nickel-chrome plating
- 15° angle for more comfortable handling



\* BULK

### WRENCH SETS

ITEM	1200I	1200J	1201TF	1200F	1202TF	1200D	1200DH	1203CF	1200G	1204CF	12009S	1205CF	1200H	120080
PIECES	11	8	15	15	14	14	13	10	10	9	9	7	7	26
PACKING														

ITEM	OPENING SIZE (A)	TOTAL LENGTH (B)	OUTSIDE DIAMETER (C) OPEN END (C1)	OUTSIDE DIAMETER (C) BOX END (C2)	HEAD THICKNESS (D) OPEN END (D1)	HEAD THICKNESS (D) BOX END (D2)	UGS	AVAILABLE	12	12	12	12	12	6	12	12	12	12	12
1208 1208H	1/4"	5"	39/64"	27/64"	13/64"	15/64"	6	✓	•	•	•	•	•	•	•	•	•	•	•
1210 1210H	5/16"	5-9/16"	45/64"	35/64"	13/64"	17/64"	6	✓	•	•	•	•	•	•	•	•	•	•	•
1212 1212H	3/8"	6"	51/64"	19/32"	15/64"	5/16"	6	✓	•	•	•	•	•	•	•	•	•	•	•
1214 1214H	7/16"	6-1/2"	15/16"	11/16"	1/4"	21/64"	6	✓	•	•	•	•	•	•	•	•	•	•	•
1216 1216H	1/2"	7"	1-3/32"	25/32"	17/64"	11/32"	6	✓	•	•	•	•	•	•	•	•	•	•	•
1218 1218H	9/16"	7-1/2"	1-13/64"	7/8"	9/32"	23/64"	6	✓	•	•	•	•	•	•	•	•	•	•	•
1220 1220H	5/8"	8-1/8"	1-21/64"	15/16"	19/64"	25/64"	6	✓	•	•	•	•	•	•	•	•	•	•	•
1222 1222H	11/16"	9"	1-29/64"	1-1/32"	21/64"	27/64"	6	✓	•	•	•	•	•	•	•	•	•	•	•
1224 1224H	3/4"	9-13/16"	1-37/64"	1-7/64"	21/64"	29/64"	6	✓	•	•	•	•	•	•	•	•	•	•	•
1226 1226H	13/16"	10-3/4"	1-11/16"	1-13/16"	3/8"	31/64"	6	✓	•	•	•	•	•	•	•	•	•	•	•
1228 1228H	7/8"	11-9/16"	1-51/64"	1-5/16"	3/8"	33/64"	6	✓	•	•	•	•	•	•	•	•	•	•	•
1230 1230H	15/16"	12-7/16"	1-29/32"	1-25/64"	13/32"	33/64"	6	✓	•	•	•	•	•	•	•	•	•	•	•
1232 1232H	1"	13-5/16"	2-1/64"	1-1/2"	7/16"	37/64"	6	✓	•	•	•	•	•	•	•	•	•	•	•
1234	1-1/16"	14-3/16"	2-9/64"	1-5/8"	29/64"	39/64"	1	✓	•	•	•	•	•	•	•	•	•	•	•
1236	1-1/8"	15-15/32"	2-17/64"	1-11/16"	15/32"	41/64"	6	✓	•	•	•	•	•	•	•	•	•	•	•
1238	1-3/16"	15-1/2"	3-1/64"	2-12/64"	39/64"	28/32"	1	✓	•	•	•	•	•	•	•	•	•	•	•
1240	1-1/4"	16-7/8"	2-33/64"	1-7/8"	33/64"	45/64"	1	✓	•	•	•	•	•	•	•	•	•	•	•
1242*	1-5/16"	17-3/4"	2-41/64"	1-15/16"	33/64"	3/4"	1	✓	•	•	•	•	•	•	•	•	•	•	•
1244*	1-3/8"	18-5/8"	2-49/64"	2-3/4"	9/16"	25/32"	1	✓	•	•	•	•	•	•	•	•	•	•	•
1246*	1-7/16"	19-7/16"	2-7/8"	2-9/64"	9/16"	13/16"	1	✓	•	•	•	•	•	•	•	•	•	•	•
1248*	1-1/2"	20-3/8"	2-1/64"	2-11/64"	9/16"	51/64"	1	✓	•	•	•	•	•	•	•	•	•	•	•
1250*	1-9/16"	23-1/8"	3-19/64"	2-25/64"	41/64"	57/64"	1	✓	•	•	•	•	•	•	•	•	•	•	•
1252*	1-5/8"	23-1/8"	3-3/8"	2-7/16"	11/16"	7/8"	1	✓	•	•	•	•	•	•	•	•	•	•	•
1254*	1-11/16"	23-1/8"	3-3/8"	2-7/16"	11/16"	15/16"	1	✓	•	•	•	•	•	•	•	•	•	•	•
1256*	1-3/4"	25-1/8"	3-5/8"	2-11/16"	11/16"	15/16"	1	✓	•	•	•	•	•	•	•	•	•	•	•
1258*	1-13/16"	25-1/8"	3-5/8"	2-21/32"	45/64"	31/32"	1	✓	•	•	•	•	•	•	•	•	•	•	•
1260*	1-7/8"	25-1/2"	4"	2-15/16"	7/8"	1-7/32"	1	✓	•	•	•	•	•	•	•	•	•	•	•
1264*	2"	25-1/2"	4"	3"	7/8"	1-7/32"	1	✓	•	•	•	•	•	•	•	•	•	•	•

**FULL POLISH COMBINATION WRENCHES**

**FULL POLISH SAE COMBINATION WRENCHES 12 POINT**



STANDARD



**SURTEK**  
TOOLS FOR SPECIALISTS



IMPROVED PRODUCT

NEW

MECHANICAL WRENCHES

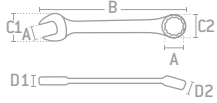

100174

- Made of chrome vanadium steel .
- Nickel-chrome plating.
- Lobular design provides excellent contact with nuts and bolts and eliminates stress on the corners.
- Exceeds ASME B107.100 standards.



ITEM	WRENCH SETS		
	1051R	1052R	1051E
PIECES	16	8	16
PACKING			
AVAILABLE	1	1	1

ITEM	OPENING SIZE (A)	TOTAL LENGTH (B)	OUTSIDE DIAMETER (C)		HEAD THICKNESS (D)		PIECES	AVAILABLE			
			OPEN END (C1)	BOX END (C2)	OPEN END (D1)	BOX END (D2)			On Request	On Request	On Request
-	1/4"								Not available for individual sale		
100160	5/16"	4-13/16"	41/64"	35/64"	5/32"	13/64"	6	✓	•	•	•
100162	3/8"	5-3/8"	49/64"	19/32"	3/16"	15/64"	6	✓	•	•	•
100164	7/16"	6"	7/8"	11/16"	13/64"	17/64"	6	✓	•	•	•
100166	1/2"	6-5/8"	1"	25/32"	7/32"	9/32"	6	On Request	•	•	•
100168	9/16"	7-5/32"	1-1/8"	23/32"	3/16"	5/16"	6	✓	•	•	•
100170	5/8"	7-3/4"	1-17/64"	31/32"	7/32"	21/64"	6	✓	•	•	•
100172	11/16"	8-11/32"	1-23/64"	1-3/64"	1/4"	5/16"	6	On Request	•	•	•
100174	3/4"	8-15/16"	1-31/64"	1-7/64"	15/64"	5/16"	6	✓	•	•	•
100176	13/16"	9-31/64"	1-9/16"	1-7/32"	0.3125"	27/64"	6	✓	•	•	•
100178	7/8"	10-1/8"	1-21/32"	1-21/64"	21/64"	29/64"	6	On Request	•	•	•
100180	15/16"	11-9/64"	1-49/64"	1-13/32"	23/64"	31/64"	6	✓	•	•	•
100182	1"	11-1/2"	1-57/64"	1-33/64"	25/64"	33/64"	6	✓	•	•	•
100184	1-1/16"	13"	1-63/64"	1-5/8"	25/64"	17/32"	6	✓	•	•	•
100186	1-1/8"	14-19/64"	2-7/64"	1-45/64"	13/32"	37/64"	6	✓	•	•	•
100190	1-1/4"	15-5/8"	2-21/64"	1-7/8"	7/16"	39/64"	6	✓	•	•	•



**SURTEK**  
TOOLS FOR SPECIALISTS

usa.urrea.com

## FULL POLISH COMBINATION WRENCHES

### FULL POLISH METRIC COMBINATION WRENCHES 6 AND 12 POINT



METRIC



URREA



NEW



1219MH

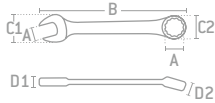

- Made of chrome vanadium steel
- Exceed ASME B107.100 standards
- Nickel-chrome plating
- 15° angle for more comfortable handling



\* BULK



#### WRENCH SETS

ITEM	1200IM	1200JM	1200QM	1206TF	1200FM	1200DHM	1200KM	12009M	1200HM	120070M
PIECES	11	8	26	15	15	13	10	9	9	19
PACKING										
AVAILABLE	1	1	1	1	1	1	1	1	1	1

ITEM	OPENING SIZE (A)	TOTAL LENGTH (B)	OUTSIDE DIAMETER (C)		HEAD THICKNESS (D)		UGS	6	AVAILABLE	WRENCH SETS												
			OPEN END (C1)	BOX END (C2)	OPEN END (D1)	BOX END (D2)				1200IM	1200JM	1200QM	1206TF	1200FM	1200DHM	1200KM	12009M	1200HM	120070M			
1206M	6 mm	5-1/16"	39/64"	13/32"	3/16"	7/32"	×	6	✓	•	•											
1207M1207MH	7 mm	5-1/16"	39/64"	13/32"	3/16"	7/32"	×	6	✓	•	•										•	
1208M1208MH	8 mm	5-9/16"	11/16"	17/32"	3/16"	9/32"	×	6	✓	•	•	•	•	•	•					•	•	
1209M1209MH	9 mm	6-1/16"	13/16"	19/32"	7/32"	5/16"	✓	6	✓	•	•	•	•	•	•						•	
1210M1210MH	10 mm	6-9/16"	15/16"	11/16"	15/64"	5/16"	✓	6	✓	•	•	•	•	•	•	•	•	•	•	•	•	•
1211M1211MH	11 mm	6-9/16"	15/16"	11/16"	15/64"	5/16"	✓	6	✓	•	•	•	•	•	•	•	•	•	•	•	•	•
1212M1212MH	12 mm	7-1/16"	1-5/64"	3/4"	1/4"	11/32"	✓	6	✓	•	•	•	•	•	•	•	•	•	•	•	•	•
1213M1213MH	13 mm	7-1/16"	1-5/64"	3/4"	1/4"	11/32"	✓	6	✓	•	•	•	•	•	•	•	•	•	•	•	•	•
1214M1214MH	14 mm	7-9/16"	1-13/64"	7/8"	17/64"	3/8"	✓	6	✓	•	•	•	•	•	•	•	•	•	•	•	•	•
1215M1215MH	15 mm	7-9/16"	1-13/64"	7/8"	17/64"	3/8"	✓	6	✓	•	•	•	•	•	•	•	•	•	•	•	•	•
1216M1216MH	16 mm	8-2/16"	1-21/64"	31/32"	9/32"	13/32"	✓	6	✓	•	•	•	•	•	•	•	•	•	•	•	•	•
1217M1217MH	17 mm	8-15/16"	1-7/16"	1-1/32"	9/32"	7/16"	✓	6	✓	•	•	•	•	•	•	•	•	•	•	•	•	•
1218M1218MH	18 mm	8-15/16"	1-7/16"	1-1/32"	5/16"	7/16"	✓	6	✓	•	•	•	•	•	•	•	•	•	•	•	•	•
1219M1219MH	19 mm	9-13/16"	1-9/16"	1-3/32"	21/64"	15/32"	✓	6	✓	•	•	•	•	•	•	•	•	•	•	•	•	•
1220M	20 mm	10-11/16"	1-11/16"	1-3/16"	5/16"	1/2"	✓	6	✓	•	•	•										
1221M	21 mm	10-11/16"	1-11/16"	1-3/16"	11/32"	1/2"	✓	6	✓	•	•	•									•	
1222M	22 mm	11-9/16"	1-25/32"	1-5/16"	3/8"	1/2"	✓	6	✓	•	•	•										•
1223M	23 mm	11-9/16"	1-25/32"	1-5/16"	3/8"	1/2"	✓	6	✓	•	•	•										•
1224M	24 mm	12-7/16"	1-29/32"	1-3/8"	25/64"	9/16"	✓	6	✓	•	•	•										•
1225M	25 mm	12-7/16"	1-29/32"	1-3/8"	25/64"	9/16"	✓	6	✓	•	•	•										•
1226M	26 mm	13-5/16"	2-1/64"	1-1/2"	13/32"	9/16"	✓	6	✓	•	•	•										•
1227M	27 mm	14-3/16"	2-1/8"	1 19/32"	7/16"	5/8"	✓	6	✓	•	•	•										•
1228M	28 mm	15-8/16"	2-17/64"	1-11/16"	7/16"	5/8"	✓	6	✓	•	•	•										•
1229M	29 mm	15-8/16"	2-17/64"	1-11/16"	7/16"	5/8"	✓	6	✓	•	•	•										•
1230M	30 mm	15-8/16"	2-17/64"	1-11/16"	7/16"	5/8"	✓	6	✓	•	•	•										•
1232M	32 mm	16-14/16"	2-1/2"	1-7/8"	15/32"	21/32"	✓	6	✓	•	•	•										•
1233M	33 mm	17-11/16"	2-1/2"	1-7/8"	15/32"	21/32"	✓	1	✓													•
1234M	34 mm	17-11/16"	2-1/2"	1-7/8"	15/32"	21/32"	✓	1	✓													•
1236M	36 mm	18-10/16"	2-5/8"	1-15/16"	1/2"	23/32"	✓	1	✓													•
1237M	37 mm	19-7/16"	2-5/8"	1-15/16"	1/2"	23/32"	✓	1	✓													•
1238M	38 mm	20-6/16"	2-3/4"	2-1/64"	17/32"	3/4"	✓	1	✓													•
1241M	41 mm	23-2/16"	2-7/8"	2-1/8"	17/32"	25/32"	✓	1	✓													•
1242M	42 mm	23-2/16"	3-1/64"	55.14	9/16"	13/16"	✓	1	✓													•
1246M	46 mm	28"	3-3/8"	2-5/32"	5/8"	29/32"	✓	1	✓													•
1250M	50 mm	28"	3-5/8"	2-3/4"	21/32"	31/32"	✓	1	✓													•
1251M	51 mm	28"	4-15/32"	2-15/16"	27/32"	1-1/4"	✓	1	✓													•



## FULL POLISH COMBINATION WRENCHES

### FULL POLISH METRIC COMBINATION WRENCHES 12 POINT



METRIC



SURTEK



NEW

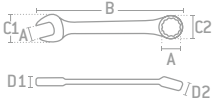

100357

- Made of chrome vanadium steel .
- Nickel-chrome plating.
- Exceeds ASME B107.100 standards.



ITEM	OPENING SIZE (A)	TOTAL LENGTH (B)	OUTSIDE DIAMETER (C)		HEAD THICKNESS (D)		PACKING	AVAILABLE	WRENCH SETS			
			OPEN END (C1)	BOX END (C2)	OPEN END (D1)	BOX END (D2)			12	12	12	12
100356	6 mm	4-11/64"	17/32"	13/32"	1/8"	3/16"	6	✓	•		•	•
100357	7 mm	4-11/64"	17/32"	13/32"	1/8"	3/16"	6	✓	•		•	•
100358	8 mm	4-13/16"	5/8"	17/32"	5/32"	3/16"	6	✓	•	•	•	•
100359	9 mm	5-3/8"	3/4"	19/32"	3/16"	7/32"	6	✓	•	•	•	•
100360	10 mm	5-3/8"	3/4"	19/32"	3/16"	7/32"	6	On Request	•	•	•	•
100361	11 mm	6"	7/8"	2/3	3/16"	1/4"	6	✓	•	•	•	•
100362	12 mm	6-5/8"	1"	3/4"	7/32"	9/32"	6	✓	•	•	•	•
100363	13 mm	6-5/8"	1"	3/4"	7/32"	9/32"	6	✓	•	•	•	•
100364	14 mm	7-5/32"	1-1/8"	7/8"	1/4"	5/26"	6	✓	•	•	•	•
100365	15 mm	7-5/32"	1-1/8"	2/3	5/32"	7/32"	6	✓	•	•	•	•
100366	16 mm	7-3/4"	1-1/4"	15/16"	1/4"	11/32"	6	✓	•	•	•	•
100367	17 mm	8-11/32"	1-11/32"	1-1/32"	1/4"	5/26"	6	✓	•	•	•	•
100368	18 mm	8-11/32"	1-11/32"	1-1/32"	7/32"	5/26"	6	✓	•	•	•	•
100369	19 mm	8-15/16"	1-7/16"	1-1/8"	1/4"	3/8"	6	✓	•	•	•	•
100370	20 mm	9-31/69"	1-17/32"	1-3/16"	5/16"	7/16"	6	✓	•	•	•	•
100371	21 mm	9-31/69"	1-17/32"	1-3/16"	5/16"	7/16"	6	✓	•	•	•	•
100372	22 mm	10-1/8"	1-5/8"	1-9/32"	11/32"	7/16"	6	✓	•	•	•	•
100373	23 mm	10-1/8"	1-5/8"	1-9/32"	11/32"	7/16"	6	✓	•	•	•	•
100374	24 mm	11-9/64"	1-3/4"	1-7/16"	3/8"	1/2"	3	On Request	•	•	•	•
100375	25 mm	11-1/2"	1-27/32"	1-1/2"	13/32"	1/2"	6	✓	•	•	•	•
100376	26 mm	11-1/2"	1-27/32"	1-1/2"	13/32"	1/2"	3	On Request	•	•	•	•
100377	27 mm	13"	1-31/32"	1-5/8"	13/32"	17/32"	3	On Request	•	•	•	•
100378	28 mm	13"	2-3/32"	1-11/16"	13/32"	9/16"	3	✓	•	•	•	•
100379	29 mm	13"	2-3/32"	1-11/16"	13/32"	9/16"	6	On Request	•	•	•	•
100380	30 mm	13"	2-5/16"	1-27/32"	7/16"	19/32"	6	On Request	•	•	•	•
100382	32 mm	13"	2-5/16"	1-27/32"	7/16"	19/32"	6	On Request	•	•	•	•



URREA  
SUPERIOR QUALITY AFFORDABLE TOOLS

usa.urrea.com

## FULL POLISH COMBINATION WRENCHES

# FULL POLISH 12-POINT EXTRA-LONG COMBINATION WRENCHES.

## EXTRA-LONG WRENCHES



- Nickel-chrome finish brings high corrosion resistance.
- Oval handle provides a more comfortable grip.
- Allows 35% more torque than a conventional wrench.
- 12-point lobular design provides a 30° recovery angle, allowing you to work faster.

### FULL POLISH SAE COMBINATION EXTRA LONG WRENCHES 12 POINT

URREA

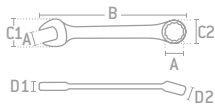

- Provides 35% more torque than a conventional wrench.
- Oval-shaped body for a more comfortable grip.
- Made of chrome vanadium steel.
- Nickel-chrome plating.
- Exceed ASME B107.100 standards.

12



1224L

#### WRENCH SETS

	1200BL	1200AL
ITEM	1200BL	1200AL
PIECES	9	11
PACKING		
AVAILABLE	1	1

ITEM	OPENING SIZE (A)	TOTAL LENGTH (B)	OUTSIDE DIAMETER (C)		HEAD THICKNESS (D)		UGS	MIRROR FINISH	AVAILABLE
			OPEN END (C1)	BOX END (C2)	OPEN END (D1)	BOX END (D2)			
1212L	3/8"	7-1/2"	51/64"	19/32"	15/64"	5/16"	✓	6	✓
1214L	7/16"	8"	15/16"	11/16"	1/4"	21/64"	✓	6	✓
1216L	1/2"	8-7/8"	1-3/32"	25/32"	17/64"	11/32"	✓	6	✓
1218L	9/16"	10"	1-13/64"	7/8"	9/32"	23/64"	✓	6	✓
1220L	5/8"	11-1/16"	1-21/64"	15/16"	19/64"	25/64"	✓	6	✓
1222L	11/16"	12"	1-29/64"	1-1/32"	21/64"	27/64"	✓	6	✓
1224L	3/4"	13-1/4"	1-37/64"	1-7/64"	21/64"	29/64"	✓	6	✓
1226L	13/16"	14"	1-11/16"	1-3/16"	3/8"	31/64"	✓	6	✓
1228L	7/8"	15"	1-51/64"	1-5/16"	3/8"	33/64"	✓	6	✓
1230L	15/16"	16"	1-29/32"	1-25/64"	13/32"	33/64"	✓	6	✓
1232L	1"	17"	2-1/64"	1-1/2"	7/16"	37/64"	✓	6	✓

### FULL POLISH METRIC COMBINATION EXTRA LONG WRENCHES 12 POINT

URREA

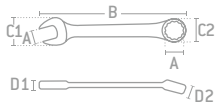

- Provides 35% more torque than a conventional wrench.
- Oval-shaped body for a more comfortable grip.
- Made of chrome vanadium steel.
- Nickel-chrome plating.
- Exceeds ASME B107.100 standards.

12



1219ML

#### WRENCH SETS

	1200BML	1200AML
ITEM	1200BML	1200AML
PIECES	9	12
PACKING		
AVAILABLE	1	1

ITEM	OPENING SIZE (A)	TOTAL LENGTH (B)	OUTSIDE DIAMETER (C)		HEAD THICKNESS (D)		UGS	MIRROR FINISH	AVAILABLE
			OPEN END (C1)	BOX END (C2)	OPEN END (D1)	BOX END (D2)			
1210ML	10 mm	8"	15/16"	11/16"	1/4"	5/16"	✓	6	✓
1211ML	11 mm	8"	15/16"	11/16"	1/4"	5/16"	✓	6	✓
1212ML	12 mm	8-7/8"	1-3/64"	51/64"	17/64"	21/64"	✓	6	✓
1213ML	13 mm	8-7/8"	1-3/64"	51/64"	17/64"	21/64"	✓	6	✓
1214ML	14 mm	10"	1-13/64"	7/8"	9/32"	11/32"	✓	6	✓
1215ML	15 mm	10"	1-13/64"	7/8"	9/32"	11/32"	✓	6	✓
1216ML	16 mm	11-1/16"	1-21/64"	13/32"	19/64"	25/64"	✓	6	✓
1217ML	17 mm	12"	1-29/64"	1-3/64"	21/64"	27/64"	✓	6	✓
1218ML	18 mm	12"	1-29/64"	1-3/64"	21/64"	27/64"	✓	6	✓
1219ML	19 mm	13-1/4"	1-37/64"	1-7/64"	21/64"	29/64"	✓	6	✓
1220ML	20 mm	14"	1-43/64"	1-13/64"	3/8"	31/64"	✓	6	✓
1221ML	21 mm	14"	1-43/64"	1-13/64"	3/8"	31/64"	✓	6	✓

SATIN FINISH COMBINATION WRENCHES 12 POINT



# SATIN FINISH 12-POINT COMBINATION WRENCHES.

## CLASSIC & JUMBO

URREA big-size combination wrenches—starting from SAE 2-1/16" and 54 mm in metric—are designed with round handles. At these large dimensions, this handle provides better grip because the round shape conforms better to the hand; the lack of square edges makes it more comfortable.



### JUMBO DESIGN

- Comfortable grip in jumbo sizes.
- Circular shape conforms better to the hand.



### CLASSIC DESIGN

- UGS design available from 3/8" to 2" and 9 mm to 51 mm.

MECHANICAL WRENCHES

SATIN FINISH SAE COMBINATION WRENCHES 12 POINT



1224A  
Classic wrench

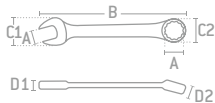

- Precision-machined jaws for a perfect fit with nuts or bolts.
- Made of chrome vanadium steel.
- Nickel-chrome plating.
- Exceeds ASME B107.100 standards.



\* BULK

ITEM	OPENING SIZE (A)	TOTAL LENGTH (B)	OUTSIDE DIAMETER (C)		HEAD THICKNESS (D)		UGS	AVAILABLE
			OPEN END (C1)	BOX END (C2)	OPEN END (D1)	BOX END (D2)		
1208A	1/4"	5"	39/64"	27/64"	13/64"	15/64"	×	6
1210A	5/16"	5-9/16"	45/64"	35/64"	13/64"	17/64"	×	6
1212A	3/8"	6"	51/64"	19/32"	15/64"	5/16"	✓	6
1214A	7/16"	6-1/2"	15/16"	11/16"	1/4"	21/64"	✓	6
1216A	1/2"	7"	1-3/32"	25/32"	17/64"	11/32"	✓	6
1218A	9/16"	7-1/2"	1-13/64"	7/8"	9/32"	23/64"	✓	6
1220A	5/8"	8-1/8"	1-21/64"	15/16"	19/64"	25/64"	✓	6
1222A	11/16"	8-15/16"	1-29/64"	1-1/32"	21/64"	27/64"	✓	6
1224A	3/4"	9-13/16"	1-37/64"	1-7/64"	21/64"	29/64"	✓	6
1226A	13/16"	10-11/16"	1-11/16"	1-13/16"	3/8"	31/64"	✓	6
1228A	7/8"	11-9/16"	1-51/64"	1-5/16"	3/8"	33/64"	✓	6
1230A	15/16"	12-7/16"	1-29/32"	1-25/64"	13/32"	33/64"	✓	6
1232A	1"	13-5/16"	2-1/64"	1-1/2"	7/16"	37/64"	✓	6
1234A	1-1/16"	14-13/64"	2-9/64"	1-5/8"	29/64"	39/64"	✓	1
1236A	1-1/8"	15-15/32"	2-17/64"	1-11/16"	15/32"	41/64"	✓	1
1238A	1-3/16"	15-1/2"	2-33/64"	1-7/8"	33/64"	45/64"	✓	1
1240A	1-1/4"	17-11/16"	2-41/64"	1-15/16"	33/64"	3/4"	✓	1
1242A*	1-5/16"	18-5/8"	2-49/64"	2-3/4"	9/16"	25/32"	✓	1
1244A*	1-3/8"	19-15/32"	2-7/8"	2-9/64"	9/16"	13/16"	✓	1
1246A*	1-7/16"	20-1/4"	2-1/64"	2-11/64"	9/16"	51/64"	✓	1
1248A*	1-1/2"	23"	3-19/64"	2-25/64"	41/64"	57/64"	✓	1
1250A*	1-9/16"	23-1/8"	3-3/8"	2-7/16"	11/16"	7/8"	✓	1
1252A*	1-5/8"	23-1/8"	3-3/8"	2-7/16"	11/16"	15/16"	✓	1
1254A*	1-11/16"	25-1/8"	3-5/8"	2-11/16"	11/16"	15/16"	✓	1
1256A*	1-3/4"	25-7/64"	3-5/8"	2-21/32"	45/64"	31/32"	✓	1
1258A*	1-13/16"	28"	4"	2-15/16"	7/8"	1-7/32"	✓	1
1260A*	1-7/8"	28"	4"	3"	7/8"	1-7/32"	✓	1
1264A*	2"	28"	4-1/2"	3"	1"	1-7/32"	✓	1

WRENCH SETS

ITEM	1200CA	1200BA	1200FA	1200DA	1200GA	120080A
PIECES	11	8	15	14	10	26
PACKING						
AVAILABLE	✓	✓	✓	✓	✓	✓

# 05 MECHANICAL WRENCHES

## SATIN FINISH COMBINATION WRENCHES 12 POINT

### SATIN FINISH SAE COMBINATION WRENCHES SET 12 POINT



**31**  
PIECES

Opening sizes		
5/16"	3/8"	7/16"
1/2"	9/16"	5/8"
11/16"	3/4"	13/16"
7/8"	15/16"	1"
1-1/16"	1-1/8"	1-1/4"
1-5/16"	1-3/8"	1-7/16"
1-1/2"	1-5/8"	1-11/16"
1-3/4"	1-13/16"	1-7/8"
2"	2-1/16"	2-1/8"
2-3/16"	2-1/4"	2-3/8"
	2-1/2"	



- Precision-machined jaws for a perfect fit with nuts or bolts.
- Made of chrome vanadium steel.
- Nickel-chrome plating.
- Exceeds ASME B107.100 standards.



ITEM	PIECES	⊞	AVAILABLE
120090	31	1	✓

### SATIN FINISH SAE COMBINATION WRENCHES SET 12 POINT



**16**  
PIECES

Opening sizes		
1-5/16"	1-3/8"	1-7/16"
1-1/2"	1-5/8"	1-11/16"
1-3/4"	1-13/16"	1-7/8"
2"	2-1/16"	2-1/8"
2-3/16"	2-1/4"	2-3/8"
	2-1/2"	



- Precision-machined jaws for a perfect fit with nuts or bolts.
- Made of chrome vanadium steel.
- Nickel-chrome plating.
- Exceeds ASME B107.100 standards.



ITEM	PIECES	⊞	AVAILABLE
1200FHD	16	1	✓

### SATIN FINISH SAE COMBINATION JUMBO WRENCHES 12 POINT

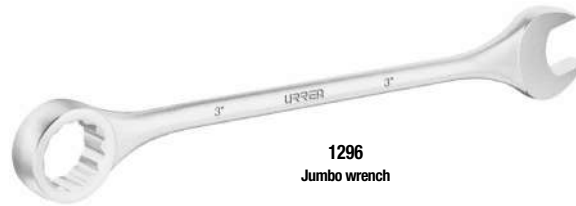
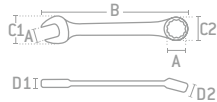

**1296**  
Jumbo wrench

- Jumbo wrenches have round handle for better grip.
- Circular shape conforms better to the hand.
- Satin finish provides corrosion resistance and a slip-resistance grip even when oil is present.
- Precision broached for tight tolerances.
- Exceeds ASME B107.100 standard.

**12**

**BULK**

ITEM	OPENING SIZE (A)	TOTAL LENGTH (B)	OUTSIDE DIAMETER (C)		HEAD THICKNESS (D)		⊞	AVAILABLE
			OPEN END (C1)	BOX END (C2)	OPEN END (D1)	BOX END (D2)		
1266	2-1/16"	30"	4-1/2"	3-7/16"	1"	1-13/32"	1	✓
1268	2-1/8"	30"	4-1/2"	3-7/16"	1"	1-13/32"	1	✓
1270	2-3/16"	30"	4-1/2"	3-7/16"	1"	1-13/32"	1	✓
1272	2-1/4"	30"	4-1/2"	3-7/16"	1"	1-13/32"	1	✓
1274	2-5/16"	30-1/2"	4-1/2"	3-39/64"	1"	1-13/32"	1	✓
1276	2-3/8"	30-1/2"	4-1/2"	3-39/64"	1"	1-13/32"	1	✓
1278	2-7/16"	30-1/2"	4-1/2"	3-45/64"	1"	1-13/32"	1	✓
1280	2-1/2"	30-1/2"	4-1/2"	3-45/64"	1"	1-13/32"	1	✓
1282	2-9/16"	33-1/2"	5-9/16"	4-1/2"	1-1/2"	1-9/16"	1	✓
1284	2-5/8"	33-1/2"	5-9/16"	4-1/2"	1-1/2"	1-9/16"	1	✓
1286	2-11/16"	33-1/2"	5-9/16"	4-1/2"	1-1/2"	1-9/16"	1	✓
1288	2-3/4"	33-1/2"	5-9/16"	4-1/2"	1-1/2"	1-9/16"	1	✓
1290	2-13/16"	33-1/2"	5-9/16"	4-1/2"	1-1/2"	1-9/16"	1	✓
1292	2-7/8"	33-1/2"	5-1/2"	4-3/4"	1-3/16"	1-11/16"	1	✓
1294	2-15/16"	33-1/2"	5-1/2"	4-3/4"	1-3/16"	1-11/16"	1	✓
1296	3"	33-1/2"	5-1/2"	4-3/4"	1-3/16"	1-11/16"	1	✓
1298	3-1/16"	33-1/2"	5-1/2"	4-3/4"	1-3/16"	1-11/16"	1	✓
1299	3-1/8"	33-1/2"	5-1/2"	4-3/4"	1-3/16"	1-11/16"	1	✓
12104	3-1/4"	37-1/2"	6-1/4"	5"	1-1/2"	1-1/2"	1	✓
12108	3-3/8"	37-1/2"	6-1/4"	5"	1-1/2"	1-1/2"	1	✓
12112	3-1/2"	37-1/2"	6-1/4"	5"	1-1/2"	1-1/2"	1	✓
12120	3-3/4"	37-1/2"	6-1/4"	5"	1-1/2"	1-1/2"	1	✓
12116	3-5/8"	37-1/2"	6-1/4"	5"	1-1/2"	1-1/2"	1	On Request
12124	3-7/8"	37-1/2"	6-1/4"	5"	1-1/2"	1-1/2"	1	✓
12128	4"	37-1/2"	6-1/4"	5"	1-1/2"	1-1/2"	1	✓

**SATIN FINISH COMBINATION WRENCHES 12 POINT**

**SATIN FINISH SAE COMBINATION JUMBO WRENCHES 12 POINT**



STANDARD



12



SATIN FINISH

URREA



NEW

MECHANICAL WRENCHES

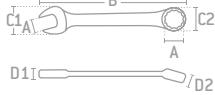

1296I

- Flat and lighter handle helps make torque work easier.
- Made of chrome vanadium steel.
- Nickel-chrome plating.
- Exceeds ASME B107.100 standards.

12

BULK

ITEM	OPENING SIZE (A)	TOTAL LENGTH (B)	OUTSIDE DIAMETER (C)		HEAD THICKNESS (D)		⊗	AVAILABLE
			OPEN END (C1)	BOX END (C2)	OPEN END (D1)	BOX END (D2)		
1266I	2-1/16"	22-1/4"	3-3/4"	3-1/16"	11/16"	1"	1	On Request
1268I	2-1/8"	24-3/16"	4-3/8"	3-1/16"	5/8"	7/8"	1	On Request
1270I	2-3/16"	24-3/16"	4-3/8"	3-1/16"	5/8"	7/8"	1	On Request
1272I	2-1/4"	24-3/16"	4-3/8"	3-1/16"	5/8"	7/8"	1	On Request
1274I	2-5/16"	24-3/16"	4-3/8"	3-1/16"	5/8"	7/8"	1	✓
1276I	2-3/8"	25-5/8"	4-3/8"	3-5/16"	11/16"	7/8"	1	✓
1278I	2-7/16"	25-5/8"	4-3/8"	3-5/16"	11/16"	7/8"	1	On Request
1280I	2-1/2"	25-5/8"	4-3/8"	3-5/16"	11/16"	7/8"	1	On Request
1282I	2-9/16"	26-9/16"	4-5/8"	3-9/16"	3/4"	1-1/16"	1	✓
1284I	2-5/8"	26-9/16"	4-5/8"	3-9/16"	3/4"	1-1/16"	1	On Request
1286I	2-11/16"	26-9/16"	4-5/8"	3-9/16"	3/4"	1-1/16"	1	On Request
1288I	2-3/4"	27-15/16"	5-3/16"	4-1/8"	15/16"	1-1/8"	1	On Request
1290I	2-13/16"	27-15/16"	5-3/16"	4-1/8"	15/16"	1-1/8"	1	✓
1292I	2-7/8"	27-15/16"	5-3/16"	4-1/8"	15/16"	1-1/8"	1	✓
1294I	2-15/16"	27-15/16"	5-3/16"	4-1/8"	15/16"	1-1/8"	1	On Request
1296I	3"	27-15/16"	5-3/16"	4-1/8"	15/16"	1-1/8"	1	On Request

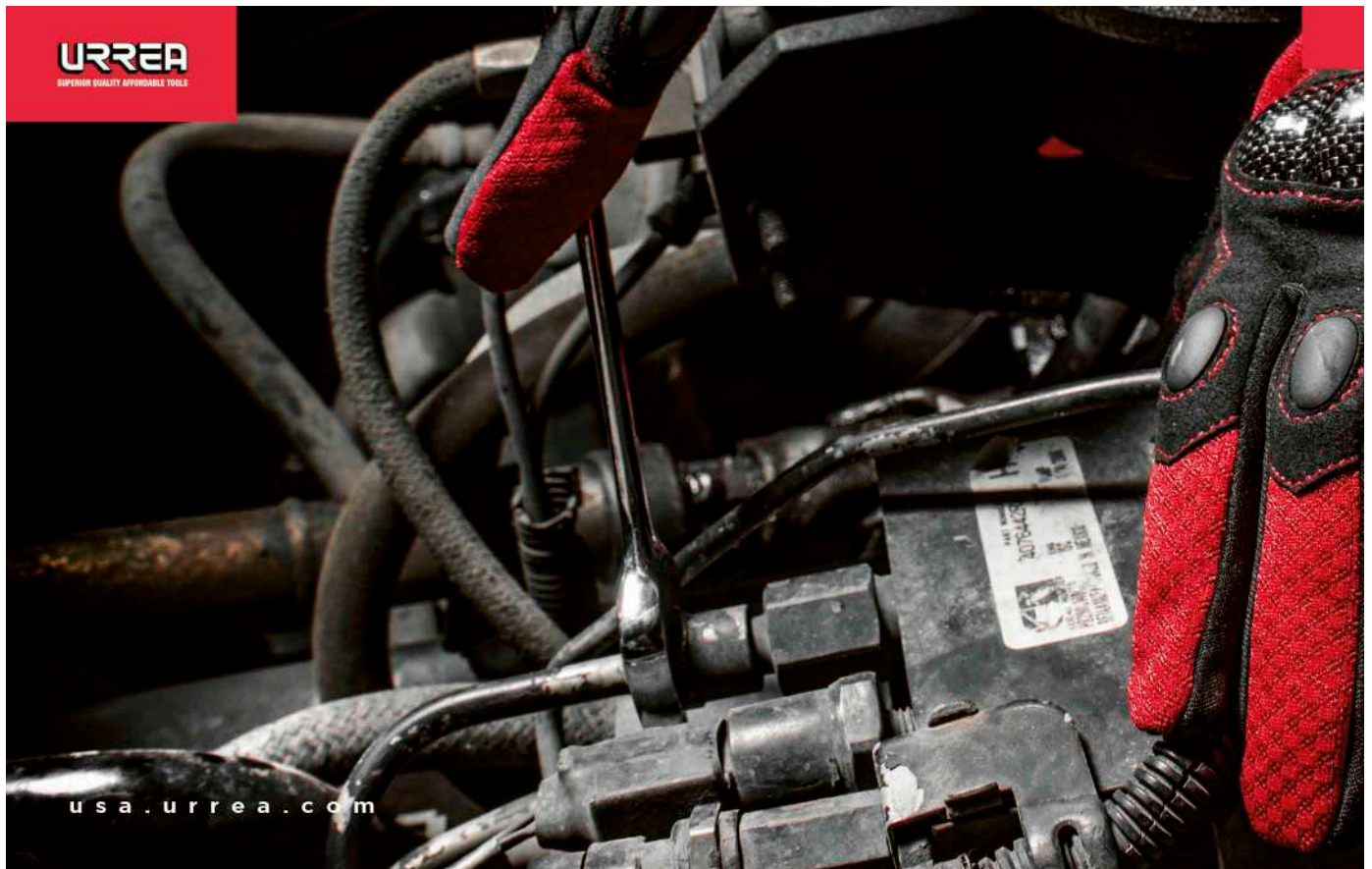

**URREA**  
SUPERIOR QUALITY AFFORDABLE TOOLS

usa.urrea.com

## SATIN FINISH COMBINATION WRENCHES 12 POINT

### SATIN FINISH METRIC COMBINATION WRENCHES 12 POINT

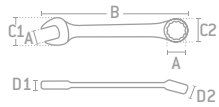

**1219MA**  
Classic wrench

- Precision-machined jaws for a perfect fit with nuts or bolts.
- Made of chrome vanadium steel.
- Nickel-chrome plating.
- Exceed ASME B107.100 standards.

### WRENCH SETS

	12	12	12	12
ITEM	1200CMA	1200BMA	1200QMA	1200FMA
PIECES	11	8	25	15
PACKING				
AVAILABLE	✓	✓	✓	✓

\* **BULK**

ITEM	OPENING SIZE (A)	TOTAL LENGTH (B)	OUTSIDE DIAMETER (C)		HEAD THICKNESS (D)		UGS	⊞	AVAILABLE
			OPEN END (C1)	BOX END (C2)	OPEN END (D1)	BOX END (D2)			
1207MA	7 mm	5"	19/32"	13/32"	3/16"	7/32"	×	6	✓
1208MA	8 mm	5-1/2"	11/16"	17/32"	3/16"	1/4"	×	6	✓
1209MA	9 mm	6"	13/16"	19/32"	7/32"	9/32"	✓	6	✓
1210MA	10 mm	6-1/2"	15/16"	11/16"	1/4"	5/16"	✓	6	✓
1211MA	11 mm	6-1/2"	15/16"	11/16"	1/4"	5/16"	✓	6	✓
1212MA	12 mm	7"	1-1/32"	25/32"	1/4"	5/16"	✓	6	✓
1213MA	13 mm	7"	1-1/32"	25/32"	1/4"	5/16"	✓	6	✓
1214MA	14 mm	7-1/2"	1-3/16"	7/8"	9/32"	11/32"	✓	6	✓
1215MA	15 mm	7-1/2"	1-3/16"	7/8"	9/32"	11/32"	✓	6	✓
1216MA	16 mm	8-1/16"	1-5/16"	31/32"	5/16"	3/8"	✓	6	✓
1217MA	17 mm	8-7/8"	1-7/16"	1-1/32"	5/16"	13/32"	✓	6	✓
1218MA	18 mm	8-7/8"	1-7/16"	1-1/32"	5/16"	13/32"	✓	6	✓
1219MA	19 mm	9-3/4"	1-9/16"	1-3/32"	5/16"	7/16"	✓	6	✓
1220MA	20 mm	10-5/8"	1-11/16"	1-3/16"	3/8"	15/32"	✓	6	✓
1221MA	21 mm	10-5/8"	1-11/16"	1-3/16"	3/8"	15/32"	✓	6	✓
1222MA	22 mm	11-1/2"	1-25/32"	1-5/16"	3/8"	1/2"	✓	6	✓
1223MA	23 mm	11-1/2"	1-25/32"	1-5/16"	3/8"	1/2"	✓	6	✓
1224MA	24 mm	12-3/8"	1-29/32"	1-13/32"	13/32"	17/32"	✓	6	✓
1225MA	25 mm	12-3/8"	1-29/32"	1-13/32"	13/32"	17/32"	✓	6	✓
1226MA	26 mm	13-1/4"	2"	1-1/2"	13/32"	9/16"	✓	6	✓
1227MA	27 mm	14-1/8"	2-1/8"	1-5/8"	7/16"	19/32"	✓	6	✓
1228MA	28 mm	15-3/8"	2-1/4"	1-11/16"	15/32"	5/8"	✓	6	✓
1229MA	29 mm	15-3/8"	2-1/4"	1-11/16"	15/32"	5/8"	✓	6	✓
1230MA	30 mm	15-3/8"	2-1/4"	1-11/16"	15/32"	5/8"	✓	6	✓
1232MA	32 mm	16-3/4"	2-1/2"	1-7/8"	1/2"	11/16"	✓	1	✓
1233MA*	33 mm	16-3/4"	2-5/8"	1-15/16"	9/16"	3/4"	✓	1	✓
1234MA*	34 mm	16-3/4"	2-5/8"	1-15/16"	9/16"	3/4"	✓	1	✓
1236MA*	36 mm	17-5/8"	2-3/4"	2-1/32"	9/16"	25/32"	✓	1	✓
1237MA*	37 mm	17-5/8"	2-7/8"	2-1/8"	9/16"	13/16"	✓	1	✓
1238MA*	38 mm	18-1/2"	3"	2-3/16"	5/8"	27/32"	✓	1	✓
1241MA*	41 mm	19-3/8"	3-3/8"	2-13/32"	11/16"	29/32"	✓	1	✓
1242MA*	42 mm	20-1/4"	3-3/8"	2-13/32"	11/16"	29/32"	✓	1	✓
1246MA*	46 mm	28"	4"	3"	27/32"	1-7/32"	✓	1	✓
1250MA*	50 mm	28"	4"	3"	27/32"	1-7/32"	✓	1	✓
1251MA*	51 mm	28"	4"	3"	27/32"	1-7/32"	✓	1	✓

### SATIN FINISH METRIC COMBINATION JUMBO WRENCHES 12 POINT

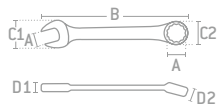

**1275MA**  
Jumbo wrench

- The specific length can present a variation of +/- 0.5"
- Satin finish.
- Exceeds ASME B107.100 standard.

**BULK**

ITEM	OPENING SIZE (A)	TOTAL LENGTH (B)	OUTSIDE DIAMETER (C)		HEAD THICKNESS (D)		⊞	AVAILABLE
			OPEN END (C1)	BOX END (C2)	OPEN END (D1)	BOX END (D2)		
1255M	55 mm	30-1/2"	4-1/2"	3-1/2"	15/16"	1-13/32"	1	✓
1260M	60 mm	30-1/2"	4-1/2"	3-19/32"	15/16"	1-13/32"	1	✓
1265M	65 mm	31"	5-17/32"	4-1/2"	1-5/32"	1-17/32"	1	✓
1270M	70 mm	32-1/2"	5-17/32"	4-1/2"	1-5/32"	1-17/32"	1	✓
1273M	73 mm	34"	5-1/2"	4-3/4"	1-5/32"	1-17/32"	1	On Request
1275M	75 mm	34"	5-17/32"	4-11/16"	1-5/32"	1-17/32"	1	✓
1280M	80 mm	35-1/2"	5-17/32"	4-11/16"	1-5/32"	1-17/32"	1	✓

**SATIN FINISH COMBINATION WRENCHES 12 POINT**

**SATIN FINISH METRIC COMBINATION JUMBO WRENCHES 12 POINT**

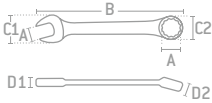

**1275MI**

- Flat and lighter handle helps make torque work easier.
- Made of chrome vanadium steel.
- Nickel-chrome plating.
- Exceeds ASME B107.100 standards.



**BULK**

ITEM	OPENING SIZE (A)	TOTAL LENGTH (B)	OUTSIDE DIAMETER (C)		HEAD THICKNESS (D)		⚡	AVAILABLE
			OPEN END (C1)	BOX END (C2)	OPEN END (D1)	BOX END (D2)		
1255MI	55 mm	24-3/16"	4-3/8"	3-1/16"	5/8"	7/8"	1	On Request
1260MI	60 mm	25-9/16"	4-3/8"	3-5/16"	11/16"	11/16"	1	On Request
1265MI	65 mm	26-9/16"	4-5/8"	3-9/16"	3/4"	3/4"	1	On Request
1270MI	70 mm	27-15/16"	5-1/8"	4-1/16"	15/16"	15/16"	1	On Request
1275MI	75 mm	27-15/16"	5-1/8"	4-1/16"	15/16"	15/16"	1	On Request

**SATIN FINISH METRIC COMBINATION WRENCHES 12 POINTS**

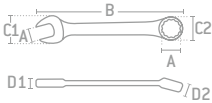

**119M**

- Flat and lighter handle helps make torque work easier.
- Made of chrome vanadium steel.
- Nickel-chrome plating.
- ASME B107.100 standards.



ITEM	OPENING SIZE (A)	TOTAL LENGTH (B)	OUTSIDE DIAMETER (C)		HEAD THICKNESS (D)		⚡	AVAILABLE
			OPEN END (C1)	BOX END (C2)	OPEN END (D1)	BOX END (D2)		
108M	8 mm	4-13/64	5/16"	17/32"	3/16"	7/32"	6	✓
109M	9 mm	5-25/64"	11/32"	19/32"	3/16"	7/32"	6	On Request
110M	10 mm	5-25/64"	13/32"	19/32"	3/16"	7/32"	6	On Request
111M	11 mm	5-29/32"	7/8"	11/16"	7/32"	1/4"	6	On Request
112M	12 mm	6-5/8"	15/32"	25/32"	7/32"	9/32"	6	On Request
113M	13 mm	6-5/8"	1/2"	25/32"	7/32"	9/32"	6	On Request
114M	14 mm	7-5/32"	1-1/8"	29/32"	1/4"	5/16"	6	On Request
115M	15 mm	7-5/32"	1-1/8"	29/32"	1/4"	5/16"	6	On Request
116M	16 mm	7-3/4"	6/8"	31/32"	9/32"	11/32"	6	On Request
117M	17 mm	8-11/32"	21/32"	1-3/64"	9/32"	3/8"	6	On Request
118M	18 mm	8-11/32"	23/32"	1-3/64"	9/32"	3/8"	6	✓
119M	19 mm	8-15/16"	3/4"	1-1/8"	9/32"	3/8"	6	On Request
120M	20 mm	9-31/64"	25/32"	1-7/32"	5/16"	13/32"	6	✓
121M	21 mm	9-31/64"	13/16"	1/8"	11/32"	13/32"	6	On Request
122M	22 mm	10-1/8"	7/8"	1-5/16"	11/32"	7/16"	6	On Request
123M	23 mm	10-1/8"	29/32"	1-5/16"	11/32"	7/16"	6	On Request
124M	24 mm	11-9/64"	15/16"	1-13/32"	3/8"	15/32"	6	✓
125M	25 mm	11-1/2"	1-7/8"	1-1/2"	13/32"	1/2"	6	✓
126M	26 mm	11-1/2"	1-7/8"	1-1/2"	13/32"	1/2"	6	✓
127M	27 mm	13"	1-31/32"	1-5/8"	13/32"	17/32"	6	✓
128M	28 mm	14-19/64"	2-3/32"	1-11/16"	7/16"	9/16"	6	✓
129M	29 mm	14-19/64"	2-3/32"	1-11/16"	7/16"	9/16"	6	✓
130M	30 mm	14-19/64"	2-11/32"	1-7/8"	7/16"	19/32"	6	✓
132M	32 mm	15-5/8"	2-11/32"	1-7/8"	7/16"	19/32"	6	✓

## BLACK COMBINATION WRENCHES

### BLACK SAE COMBINATION WRENCHES - 12 POINT

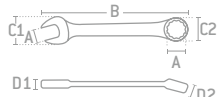

1222B

- Precision-machined openings for a perfect fit with nuts or bolts.
- Available in 12-point design, allowing a 30° recovery angle.
- High-quality micro-alloy steel and controlled heat treatment.
- Phosphatized finish ideal for industries where chrome particle shedding is critical.
- Exceeds ASME B107.100 standard.



		WRENCH SETS	
		12	12
ITEM	PIECES	1200FB	1200HB
		15	7
PACKING			
		1	1
AVAILABLE		✓	✓

ITEM	OPENING SIZE (A)	TOTAL LENGTH (B)	OUTSIDE DIAMETER (C)		HEAD THICKNESS (D)		UGS	BULK	AVAILABLE
			OPEN END (C1)	BOX END (C2)	OPEN END (D1)	BOX END (D2)			
1210B	5/16"	5-9/16"	45/64"	35/64"	13/64"	17/64"	×	6	✓
1212B	3/8"	6"	51/64"	19/32"	15/64"	5/16"	✓	6	•
1214B	7/16"	6-1/2"	15/16"	11/16"	1/4"	21/64"	✓	6	•
1216B	1/2"	7"	1-3/32"	25/32"	17/64"	11/32"	✓	6	•
1218B	9/16"	7-1/2"	1-13/64"	7/8"	9/32"	23/64"	✓	6	•
1220B	5/8"	8-1/8"	1-21/64"	15/16"	19/64"	25/64"	✓	6	•
1222B	11/16"	9"	1-29/64"	1-1/32"	21/64"	27/64"	✓	6	•
1224B	3/4"	9-13/16"	1-37/64"	1-7/64"	21/64"	29/64"	✓	6	•
1226B	13/16"	10-3/4"	1-11/16"	1-13/16"	3/8"	31/64"	✓	6	•
1228B	7/8"	11-9/16"	1-51/64"	1-5/16"	3/8"	33/64"	✓	6	•
1230B	15/16"	12-7/16"	1-29/32"	1-25/64"	13/32"	33/64"	✓	6	•
1232B	1"	13-5/16"	2-1/64"	1-1/2"	7/16"	37/64"	✓	6	•
1234B	1-1/16"	14-3/16"	2-9/64"	1-5/8"	29/64"	39/64"	✓	1	•
1236B	1-1/8"	15-15/32"	2-17/64"	1-11/16"	15/32"	41/64"	✓	1	•
1238B	1-3/16"	15-1/2"	3-1/64"	2-12/64"	39/64"	28/32"	✓	1	•
1240B	1-1/4"	16-7/8"	2-33/64"	1-7/8"	33/64"	45/64"	✓	1	•
1242B*	1 5/16"	17-3/4"	2-41/64"	1-15/16"	33/64"	3/4"	✓	1	•
1246B*	1-7/16"	19-7/16"	2-7/8"	2-9/64"	9/16"	13/16"	✓	1	•
1248B*	1-1/2"	20-3/8"	2-1/64"	2-11/64"	9/16"	15/16"	✓	1	•
1252B*	1-5/8"	23-1/8"	3-3/8"	2-7/16"	11/16"	7/8"	✓	1	•
1254B*	1-11/16"	23-1/8"	3-3/8"	2-7/16"	11/16"	15/16"	✓	1	•
1256B*	1-3/4"	25-1/8"	3-5/8"	2-11/16"	11/16"	15/16"	✓	1	On Request
1258B*	1-13/16"	25-1/8"	3-5/8"	2-21/32"	45/64"	31/32"	✓	1	•
1260B*	1-7/8"	25-1/2"	4"	2-15/16"	7/8"	1-7/32"	✓	1	•
1264B*	2"	25-1/2"	4"	3"	7/8"	1-7/32"	✓	1	•

### BLACK METRIC COMBINATION WRENCHES - 12 POINT

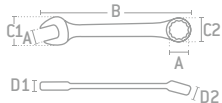

1219MB

- Precision-machined openings for a perfect fit with nuts or bolts.
- Available in 12-point design, allowing a 30° recovery angle.
- High-quality micro-alloy steel and controlled heat treatment.
- Phosphatized finish ideal for industries where chrome particle shedding is critical.
- Exceeds ASME B107.100 standard.



		WRENCH SET	
		12	
ITEM	PIECES	1200FMB	
		7	
PACKING			
		1	
AVAILABLE		✓	✓

ITEM	OPENING SIZE	TOTAL LENGTH (A)	OUTSIDE DIAMETER (B)		HEAD THICKNESS (C)		UGS	BULK	AVAILABLE
			OPEN END (B1)	BOX END (B2)	OPEN END (C1)	BOX END (C2)			
1207MB	7 mm	5-1/16"	39/64"	13/32"	3/16"	7/32"	×	6	✓
1208MB	8 mm	5-9/16"	11/16"	17/32"	3/16"	9/32"	×	6	•
1209MB	9 mm	6-1/16"	13/16"	19/32"	7/32"	5/16"	×	6	•
1210MB	10 mm	6-9/16"	15/16"	11/16"	15/64"	5/16"	✓	6	•
1211MB	11 mm	6-9/16"	15/16"	11/16"	15/64"	5/16"	✓	6	•
1212MB	12 mm	7-1/16"	1-5/64"	3/4"	1/4"	11/32"	✓	6	•
1213MB	13 mm	7-1/16"	1-5/64"	3/4"	1/4"	11/32"	✓	6	•
1214MB	14 mm	7-9/16"	1-13/64"	7/8"	17/64"	3/8"	✓	6	•
1215MB	15 mm	7-9/16"	1-13/64"	7/8"	17/64"	3/8"	✓	6	•
1216MB	16 mm	8-2/16"	1-21/64"	31/32"	9/32"	13/32"	✓	6	•
1217MB	17 mm	8-15/16"	1-7/16"	1-1/32"	9/32"	7/16"	✓	6	•
1218MB	18 mm	8-15/16"	1-7/16"	1-1/32"	9/32"	7/16"	✓	6	•
1219MB	19 mm	9-13/16"	1-9/16"	1-3/32"	21/64"	15/32"	✓	6	•
1220MB	20 mm	10-11/16"	1-11/16"	1-3/16"	5/16"	1/2"	✓	6	•
1221MB	21 mm	10-11/16"	1-11/16"	1-3/16"	11/32"	1/2"	✓	6	•
1222MB	22 mm	11-9/16"	1-25/32"	1-5/16"	3/8"	1/2"	✓	1	•
1223MB	23 mm	11-9/16"	1-25/32"	1-5/16"	3/8"	1/2"	✓	1	•
1224MB	24 mm	12-7/16"	1-29/32"	1-3/8"	25/64"	9/16"	✓	1	•
1225MB	25 mm	12-7/16"	1-29/32"	1-3/8"	25/64"	9/16"	✓	1	•
1226MB	26 mm	13-5/16"	2-1/64"	1-1/2"	13/32"	9/16"	✓	1	•
1227MB	27 mm	14-3/16"	2-1/8"	1 19/32"	7/16"	5/8"	✓	1	•
1228MB	28 mm	15-8/16"	2-17/64"	1-11/16"	7/16"	5/8"	✓	1	•
1229MB	29 mm	15-8/16"	2-17/64"	1-11/16"	7/16"	5/8"	✓	1	•
1230MB	30 mm	15-8/16"	2-17/64"	1-11/16"	7/16"	5/8"	✓	1	•
1236MB*	36 mm	18-10/16"	2-5/8"	1-15/16"	1/2"	23/32"	✓	1	•



FULL POLISH FLEX HEAD COMBINATION WRENCHES

FLEXIBLE  
**SOCKET**

These wrenches combine a fixed open-end with a 15° offset and a flexible socket that rotates 180°, allowing operation at any angle and making it easier to work in hard-to-reach places.



180°  
ROTATION

Reinforced design supports torque applied with a flex socket



LOBULAR  
12-POINT

Lobular 12-point socket box-end. Manufactured from chrome-vanadium steel with a full polish finish.



FULL POLISH FLEX HEAD  
**WRENCHES.**

FULL POLISH SAE FLEX HEAD COMBINATION WRENCHES 12 POINT



STANDARD



MIRROR-FINISH

URREA



MECHANICAL WRENCHES

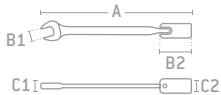

1270-24

- Made of chrome vanadium steel.
- Exceeds ASME B107.100 standards.
- Nickel-chrome plating.
- Makes work easier in hard-to-reach areas.



ITEM	OPENING SIZE	TOTAL LENGTH (A)	OUTER DIAMETER (B1)	NUT END LENGTH (B2)	HEAD THICKNESS (C1)	NUT END OUTSIDE DIAMETER (C2)	AVAILABLE
1270-12	3/8"	7-3/32"	51/64"	7/8"	1/4"	9/16"	6 ✓
1270-14	7/16"	7-1/2"	15/16"	7/8"	5/16"	5/8"	6 ✓
1270-16	1/2"	8-1/4"	1-3/32"	1"	1/4"	3/4"	6 ✓
1270-18	9/16"	9-1/16"	1-13/64"	1-5/32"	9/32"	7/8"	6 ✓
1270-20	5/8"	9-1/4"	1-21/64"	1-9/32"	5/16"	15/16"	6 ✓
1270-22	11/16"	9-1/4"	1-29/64"	1-5/16"	5/16"	15/16"	6 ✓
1270-24	3/4"	10"	1-37/64"	1-5/16"	11/32"	1"	6 ✓

BULK

WRENCH SET	
ITEM	1270HF
PIECES	7
PACKING	
AVAILABLE	1 ✓

FULL POLISH METRIC FLEX HEAD COMBINATION WRENCHES 12 POINT



METRIC



MIRROR-FINISH

URREA

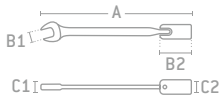

1270-19M

- Made of chrome vanadium steel.
- Exceeds ASME B107.100 standards.
- Nickel-chrome plating.
- Makes work easier in hard-to-reach areas.



ITEM	OPENING SIZE	TOTAL LENGTH (A)	OUTER DIAMETER (B1)	NUT END LENGTH (B2)	HEAD THICKNESS (C1)	NUT END OUTSIDE DIAMETER (C2)	AVAILABLE
1270-10M	10 mm	7-3/32"	15/16"	7/8"	3/16"	9/16"	6 ✓
1270-11M	11 mm	7-1/2"	15/16"	7/8"	9/32"	5/8"	6 ✓
1270-12M	12 mm	7-11/16"	1 3/64"	1"	9/32"	11/16"	6 ✓
1270-13M	13 mm	8-1/4"	1 3/64"	1 1/8"	1/4"	3/4"	6 ✓
1270-14M	14 mm	9-1/16"	1-13/64"	1-5/32"	9/32"	7/8"	6 ✓
1270-15M	15 mm	9-1/16"	1-13/64"	1-1/4"	9/32"	15/16"	6 ✓
1270-16M	16 mm	9-1/4"	1-21/64"	1-1/4"	5/16"	15/16"	6 ✓
1270-17M	17 mm	9-1/4"	1-29/64"	1-1/4"	5/16"	15/16"	6 ✓
1270-18M	18 mm	10"	1-29/64"	1-1/4"	3/8"	1"	6 ✓
1270-19M	19 mm	10"	1-37/64"	1-1/4"	3/8"	1"	6 ✓

BULK

WRENCH SET	
ITEM	1270HMF
PIECES	10
PACKING	
AVAILABLE	1 ✓

## COMBINATION RATCHETING WRENCHES

MECHANICAL WRENCHES

### FULL POLISH SAE COMBINATION SHORT RATCHETING WRENCH SET 12 POINT

**7**  
PIECES



Sizes		
5/16"	7/16"	9/16"
3/8"	1/2"	5/8"
	3/4"	

- Made of chrome vanadium steel.
- Exceeds ASME B107.100 standards.
- Nickel-chrome plating.
- Makes work easier in hard-to-reach areas.
- 72-tooth ratcheting system.



ITEM	PIECES	AVAILABLE
12MS7	7	1 ✓

### FULL POLISH SAE COMBINATION SHORT RATCHETING WRENCH SET 12 POINT

**7**  
PIECES



Sizes		
3/8"	1/2"	5/8"
7/16"	9/16"	11/16"
	3/4"	

- Made of chrome vanadium steel.
- Exceeds ASME B107.100 standards.
- Nickel-chrome plating.
- Makes work easier in hard-to-reach areas.
- 72-tooth ratcheting system.



ITEM	PIECES	AVAILABLE
100576	7	1 On Request

### FULL POLISH METRIC COMBINATION SHORT RATCHETING WRENCH SET 12 POINT

**7**  
PIECES



Sizes		
8 mm	12 mm	14 mm
10 mm	13 mm	15 mm
	19 mm	

- Made of chrome vanadium steel.
- Exceeds ASME B107.100 standards.
- Nickel-chrome plating.
- Makes work easier in hard-to-reach areas.
- 72-tooth ratcheting system.



ITEM	PIECES	AVAILABLE
12MS7M	7	1 ✓

### FULL POLISH METRIC COMBINATION SHORT RATCHETING WRENCH SET 12 POINT

**7**  
PIECES



Sizes		
10 mm	13 mm	15 mm
12 mm	14 mm	17 mm
	19 mm	

- Made of chrome vanadium steel.
- Exceeds ASME B107.100 standards.
- Nickel-chrome plating.
- Makes work easier in hard-to-reach areas.
- 72-tooth ratcheting system.



ITEM	PIECES	AVAILABLE
100577	7	1 On Request

### FULL POLISH SAE REVERSIBLE COMBINATION RATCHETING WRENCH SET 12 POINT

**7**  
PIECES



Sizes		
5/16"	7/16"	9/16"
3/8"	1/2"	5/8"
	3/4"	

- Made of chrome vanadium steel.
- Exceeds ASME B107.100 standards.
- Nickel-chrome plating.
- Makes work easier in hard-to-reach areas.
- 72-tooth ratcheting system.



ITEM	PIECES	AVAILABLE
12MR7	7	1 ✓

### FULL POLISH SAE REVERSIBLE COMBINATION RATCHETING WRENCH SET 12 POINT

**7**  
PIECES



Sizes		
3/8"	1/2"	5/8"
7/16"	9/16"	11/16"
	3/4"	

- Made of chrome vanadium steel.
- Exceeds ASME B107.100 standards.
- Nickel-chrome plating.
- Makes work easier in hard-to-reach areas.
- 72-tooth ratcheting system.



ITEM	PIECES	AVAILABLE
100574	7	1 On Request

**COMBINATION RATCHETING WRENCHES**

**FULL POLISH METRIC REVERSIBLE COMBINATION RATCHETING WRENCH SET 12 POINT**

HEAVY DUTY METRIC C 12 SUPER DRIVE RATCHET SYSTEM REVERSIBLE RATCHETING MIRROR-FINISH

**7** PIECES

Sizes		
8 mm	12 mm	14 mm
10 mm	13 mm	15 mm
	19 mm	

- Made of chrome vanadium steel.
- Exceeds ASME B107.100 standards.
- Nickel-chrome plating.
- Makes work easier in hard-to-reach areas.
- 72-tooth ratcheting system.



ITEM	PIECES	AVAILABILITY
12MR7M	7	1 ✓

**FULL POLISH METRIC REVERSIBLE COMBINATION RATCHETING WRENCH SET 12 POINT**

PROFESSIONAL USE METRIC C 12 RATCHET SYSTEM REVERSIBLE RATCHETING MIRROR-FINISH

**7** PIECES

Sizes		
10 mm	13 mm	15 mm
12 mm	14 mm	17 mm
	19 mm	

- Made of chrome vanadium steel.
- Exceeds ASME B107.100 standards.
- Nickel-chrome plating.
- Makes work easier in hard-to-reach areas.
- 72-tooth ratcheting system.



ITEM	PIECES	AVAILABILITY
100575	7	1 On Request

**FULL POLISH SAE FLEX HEAD COMBINATION RATCHETING WRENCH SET 12 POINT**

HEAVY DUTY STANDARD C 12 SUPER DRIVE RATCHET SYSTEM FLEX-HEAD MIRROR-FINISH

**7** PIECES

Sizes		
5/16"	7/16"	9/16"
3/8"	1/2"	5/8"
	3/4"	

- Made of chrome vanadium steel.
- Exceeds ASME B107.100 standards.
- Nickel-chrome plating.
- Makes work easier in hard-to-reach areas.
- 72-tooth ratcheting system.



ITEM	PIECES	AVAILABILITY
12MF7	7	1 ✓

**FULL POLISH METRIC FLEX HEAD COMBINATION RATCHETING WRENCH SET 12 POINT**

HEAVY DUTY METRIC C 12 SUPER DRIVE RATCHET SYSTEM FLEX-HEAD MIRROR-FINISH

**7** PIECES

Sizes		
8 mm	12 mm	14 mm
10 mm	13 mm	15 mm
	19 mm	

- Made of chrome vanadium steel.
- Exceeds ASME B107.100 standards.
- Nickel-chrome plating.
- Makes work easier in hard-to-reach areas.
- 72-tooth ratcheting system.



ITEM	PIECES	AVAILABILITY
12MF7M	7	1 ✓



**URREA**  
SUPERIOR QUALITY AFFORDABLE TOOLS

usa.urrea.com

## COMBINATION RATCHETING WRENCHES

### FULL POLISH SAE COMBINATION RATCHETING WRENCHES 12 POINT

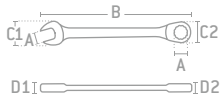

1224CM

- Made of chrome vanadium steel.
- Exceeds ASME B107.100 standards.
- Nickel-chrome plating
- 2-tooth ratcheting system with 5° arc swing.
- Makes work easier in hard-to-reach areas.



		WRENCH SETS		
		12	12	12
ITEM		1202CM	1201CM	1200CM
PIECES		19	12	7
PACKING				
		1	1	1
AVAILABLE		✓	✓	✓

ITEM	OPENING SIZE	TOTAL LENGTH (A)	OUTSIDE DIAMETER (B) OPEN END (B1) BOX END (B2)	HEAD THICKNESS (C) OPEN END (C1) BOX END (C2)	TEETH	SWING ARC	12	AVAILABLE
1208CM	1/4"	5-1/2"	1/4" 5/16"	17/32" 3/16"	72	5°	1	✓
1210CM	5/16"	5-1/2"	9/32" 3/8"	5/8" 7/32"	72	5°	1	✓
1212CM	3/8"	6-3/16"	5/16" 7/16"	11/16" 1/4"	72	5°	1	✓
1214CM	7/16"	6-1/2"	15/32" 1/2"	27/32" 7/32"	72	5°	1	✓
1216CM	1/2"	7"	9/16" 9/16"	31/32" 9/32"	72	5°	1	✓
1218CM	9/16"	7-1/2"	17/32" 19/32"	1-3/32" 5/16"	72	5°	1	✓
1220CM	5/8"	8-1/8"	11/16" 5/8"	1-1/4" 11/32"	72	5°	1	✓
1222CM	11/16"	9-13/16"	21/32" 11/16"	1-11/32" 11/32"	72	5°	1	✓
1224CM	3/4"	9-3/4"	11/16" 3/4"	1-15/32" 3/8"	72	5°	1	✓
1226CM	13/16"	10-5/16"	7/8" 7/8"	1-1/2" 7/16"	72	5°	1	✓
1228CM	7/8"	11-5/16"	3/4" 15/16"	1-21/32" 1/2"	72	5°	1	✓
1230CM	15/16"	5-1/2"	29/32" 1"	1-23/32" 15/32"	72	5°	1	✓
1232CM	1"	12-5/8"	2-3/16" 2"	3/8" 19/32"	72	5°	1	✓
1234CM	1-1/16"	14-1/8"	2-3/16" 2-1/16"	13/32" 5/8"	72	5°	1	✓
1236CM	1-1/8"	14-1/8"	2-3/16" 2-1/16"	27/64" 5/8"	72	5°	1	✓
1240CM	1-1/4"	16-11/16"	2-17/32" 2-5/16"	17/32" 11/16"	72	5°	1	✓
1242CM*	1-5/16"	16-11/16"	3-1/16" 2-5/8"	39/64" 3/4"	72	5°	1	✓
1244CM*	1-3/8"	19"	3-1/16" 2-5/8"	39/64" 47/64"	72	5°	1	✓
1246CM*	1-7/8"	19"	3-1/16" 2-9/16"	39/64" 47/64"	72	5°	1	✓

### FULL POLISH SAE COMBINATION RATCHETING WRENCHES 12 POINT

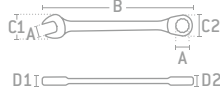

100544

- Made of chrome vanadium steel.
- Exceeds ASME B107.100 standards.
- Nickel-chrome plating
- 2-tooth ratcheting system.



		WRENCH SET	
		12	
ITEM		100568	
PIECES		7	
PACKING			
		1	
AVAILABLE		On Request	

ITEM	OPENING SIZE (A)	TOTAL LENGTH (B)	OUTSIDE DIAMETER (C) OPEN END (C1) BOX-END (C2)	HEAD THICKNESS (D) OPEN END (D1) BOX-END (D2)	TEETH	SWING ARC	12	AVAILABLE
100528	1/4"	120 mm	9/16" 17/32"	5/32" 1/4"	3	5°	1	On Request
100530	5/16"	135 mm	2/3" 2/3"	3/16" 9/32"	3	5°	1	On Request
100532	3/8"	154 mm	13/16" 13/16"	1/4" 9/32"	3	5°	1	On Request
100534	7/16"	165 mm	29/32" 29/32"	1/4" 11/32"	3	5°	1	On Request
100536	1/2"	178 mm	1-1/16" 1"	9/32" 11/32"	3	5°	1	On Request
100538	9/16"	189 mm	1-3/16" 1-1/16"	9/32" 3/8"	3	5°	1	On Request
100540	5/8"	205 mm	1-11/32" 1-7/32"	9/32" 13/32"	3	5°	1	On Request
100544	3/4"	240 mm	1-9/16" 1-13/32"	11/32" 7/16"	3	5°	1	On Request
100545	13/16"	281 mm	1-3/4" 1-21/32"	3/8" 17/32"	1	5°	1	On Request
100546	7/8"	281 mm	1-3/4" 1-21/32"	3/8" 17/32"	1	5°	1	On Request
100547	15/16"	325 mm	2-1/32" 1-15/16"	13/32" 9/16"	1	5°	1	On Request
100548	1"	325 mm	2-1/32" 1-15/16"	13/32" 9/16"	1	5°	1	On Request

**COMBINATION RATCHETING WRENCHES**

**FULL POLISH METRIC COMBINATION RATCHETING WRENCHES 12 POINT**



**URREA**  
TOOL & EQUIPMENT

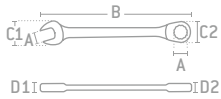

**1219MCM**

- Made of chrome vanadium steel.
- Exceeds ASME B107.100 standards.
- Nickel-chrome plating
- 2-tooth ratcheting system with 5° arc swing.
- Makes work easier in hard-to-reach areas.



**\* BULK**

		WRENCH SETS		
		12	12	12
ITEM		1202MCM	1201MCM	1200MCM
PIECES		22	15	7
PACKING				
		1	1	1
AVAILABLE		✓	✓	✓

ITEM	OPENING SIZE	TOTAL LENGTH (A)	OUTSIDE DIAMETER (B) OPEN END (B1) BOX END (B2)	HEAD THICKNESS (C) OPEN END (C1) BOX END (C2)	TEETH	SWING ARC	12	AVAILABLE
1206MCM	6 mm	5-1/2"	21/32" 43/64"	3/16" 7/32"	72	5°	1	✓
1207MCM	7 mm	5-1/2"	21/32" 21/32"	3/16" 15/64"	72	5°	1	✓
1208MCM	8 mm	5-1/2"	1/4" 17/32"	5/8" 1/4"	72	5°	1	✓
1209MCM	9 mm	6-7/8"	3/8" 19/32"	23/32" 9/32"	72	5°	1	✓
1210MCM	10 mm	6-1/4"	5/16" 11/16"	23/32" 5/16"	72	5°	1	✓
1211MCM	11 mm	6-1/2"	7/16" 11/16"	27/32" 5/16"	72	5°	1	✓
1212MCM	12 mm	6-3/4"	15/32" 25/32"	31/32" 5/16"	72	5°	1	✓
1213MCM	13 mm	7"	1/2" 25/32"	15/16" 5/16"	72	5°	1	✓
1214MCM	14 mm	7-1/2"	17/32" 7/8"	1-1/8" 11/32"	72	5°	1	✓
1215MCM	15 mm	7-13/16"	17/32" 7/8"	1-3/32" 11/32"	72	5°	1	✓
1216MCM	16 mm	8-3/16"	9/16" 31/32"	1-1/4" 3/8"	72	5°	1	✓
1217MCM	17 mm	8-13/16"	11/16" 1-1/32"	1-9/32" 13/32"	72	5°	1	✓
1218MCM	18 mm	9-1/4"	5/8" 1-1/32"	1-11/32" 13/32"	72	5°	1	✓
1219MCM	19 mm	9-3/4"	3/4" 1-3/32"	1-7/16" 7/16"	72	5°	1	On Request
1220MCM	20 mm	9-3/4"	1-5/8" 1-13/32"	5/16" 7/16"	72	5°	1	✓
1221MCM	21 mm	11-5/16"	27/32" 1-3/16"	1-1/2" 15/32"	72	5°	1	✓
1222MCM	22 mm	11-5/16"	27/32" 1-5/16"	1-5/8" 1/2"	72	5°	1	✓
1224MCM	24 mm	12-9/16"	27/32" 1-13/32"	1-23/32" 17/32"	72	5°	1	✓
1225MCM	25 mm	12-5/8"	2-1/32" 1-13/16"	25/64" 19/32"	72	5°	1	✓
1227MCM	27 mm	14-1/8"	2-3/16" 2-1/32"	27/64" 5/8"	72	5°	1	✓
1230MCM	30 mm	16-11/16"	2-9/16" 2-5/16"	17/32" 11/16"	72	5°	1	✓
1232MCM	32 mm	16-11/16"	2-35/64" 2-11/32"	35/64" 45/64"	72	5°	1	✓
1234MCM*	34 mm	19"	3-1/16" 2-5/8"	37/64" 49/64"	72	5°	1	✓
1236MCM*	36 mm	19"	3-3/32" 2-5/8"	37/64" 49/64"	72	5°	1	✓

MECHANICAL WRENCHES

**FULL POLISH METRIC COMBINATION RATCHETING WRENCHES 12 POINT**



**SURTEK**  
TOOL & EQUIPMENT



**100589**

- Made of chrome vanadium steel.
- Exceeds ASME B107.100 standards.
- Nickel-chrome plating
- 2-tooth ratcheting system.



		WRENCH SET	
		12	
ITEM		100569	
PIECES		7	
PACKING			
		1	
AVAILABLE		On Request	

ITEM	OPENING SIZE (A)	TOTAL LENGTH (B)	OUTSIDE DIAMETER (C) OPEN END (C1) BOX-END (C2)	HEAD THICKNESS (D) OPEN END (D1) BOX-END (D2)	12	AVAILABLE
100578	8mm	140mm	17-1/2" 17-4/5"	5-2/7" 7-1/5"	3	On Request
100579	9mm	150mm	19-1/2" 19-1/2"	5-5/7" 7-1/2"	1	On Request
100580	10mm	160mm	21" 21"	6" 7-4/5"	3	On Request
100581	11mm	165mm	23-1/2" 23"	6-1/5" 8-2/5"	1	On Request
100582	12mm	170mm	25-1/2" 24-2/5"	6-1/2" 8-4/5"	3	On Request
100583	13mm	180mm	27" 25-4/5"	6-4/5" 9"	3	On Request
100584	14mm	190mm	30" 27-2/5"	7-1/5" 9-2/5"	3	On Request
100585	15mm	200mm	32-1/9" 29-2/5"	7-1/2" 9-4/5"	3	On Request
100586	16mm	210mm	34" 31"	7-4/5" 10-1/5"	1	On Request
100587	17mm	225mm	36" 32 1/2"	8" 10-1/2"	1	On Request
100588	18mm	235mm	38-1/2" 34 1/2"	8-1/2" 10-4/5"	3	On Request
100589	19mm	245mm	40-2/7" 36"	8-4/5" 11-1/5"	3	On Request
100590	21mm	290mm	44-2/7" 42-2/7"	9-1/2" 13-1/2"	1	On Request
100591	22mm	290mm	44-2/7" 42-2/7"	9-1/2" 13-1/2"	1	On Request
100592	24mm	332mm	52-1/2" 49-1/9"	10-1/2" 14-1/2"	1	On Request

## SPLINE COMBINATION RATCHETING WRENCHES

# COMBINATION SPLINE RATCHETING WRENCHES.



### 72 TEETH RATCHETING SYSTEM

5° SWING ARC



**SPLINE**

The spline design offers higher strength in a more compact profile, making it common in military and commercial aircraft applications. The precise fit between spline drive and fastener also helps prevent rounding or breaking off of fasteners edges.



SPLINE



RATCHET SYSTEM



CHROME VANADIUM



MIRROR FINISH

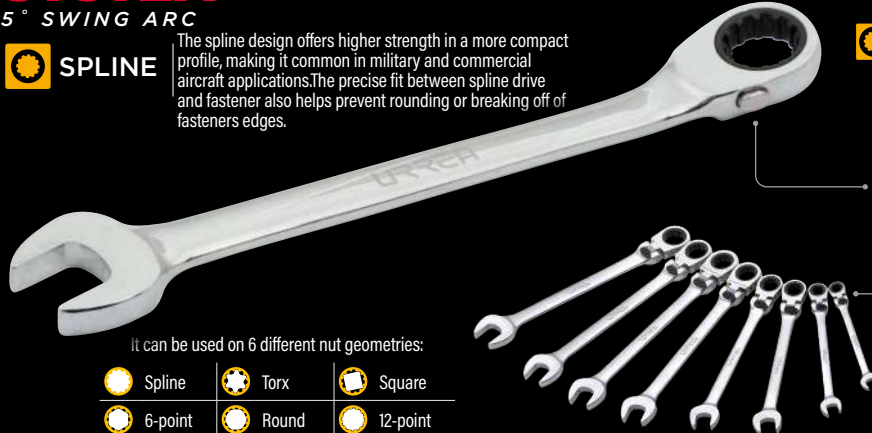

REVERSIBLE RATCHETING

With reversible function for increased working speed (check applicable items in the product description).



FLEX HEAD

With flexible head for greater application versatility (check applicable items in the product description).

It can be used on 6 different nut geometries:

- Spline
- Torx
- Square
- 6-point
- Round
- 12-point

### FULL POLISH SAE SPLINE FLEX HEAD COMBINATION RATCHETING WRENCH SET



**8 PIECES**

Sizes
5/16"
3/8"
7/16"
1/2"
9/16"
5/8"
11/16"
3/4"



- Made of chrome vanadium steel.
- Exceeds ASME B107.100 standards.
- Nickel-chrome plating
- For hard-to-reach places with a locking mechanism that provides a fixed position.

ITEM	PIECES	☐	AVAILABLE
12MF8	8	1	✓

### FULL POLISH METRIC SPLINE FLEX HEAD COMBINATION RATCHETING WRENCH SET



**12 PIECES**

Sizes
8 mm
9 mm
10 mm
11 mm
12 mm
13 mm
14 mm
15 mm
16 mm
17 mm
18 mm
19 mm



- Made of chrome vanadium steel.
- Exceeds ASME B107.100 standards.
- Nickel-chrome plating
- For hard-to-reach places with a locking mechanism that provides a fixed position.

ITEM	PIECES	☐	AVAILABLE
12MF12M	12	1	✓

### FULL POLISH SAE SPLINE COMBINATION RATCHETING WRENCH SET



**9 PIECES**

Sizes
1/4"
5/16"
3/8"
7/16"
1/2"
9/16"
5/8"
11/16"
3/4"



- Made of chrome vanadium steel.
- Exceeds ASME B107.100 standards.
- Nickel-chrome plating

ITEM	PIECES	☐	AVAILABLE
JLMC9	9	1	✓

### FULL POLISH METRIC SPLINE COMBINATION RATCHETING WRENCH SET



**12 PIECES**

Sizes
8 mm
9 mm
10 mm
11 mm
12 mm
13 mm
14 mm
15 mm
16 mm
17 mm
18 mm
19 mm



- Made of chrome vanadium steel.
- Exceeds ASME B107.100 standards.
- Nickel-chrome plating

ITEM	PIECES	☐	AVAILABLE
JLMC12M	12	1	✓

**SPLINE COMBINATION RATCHETING WRENCHES**

**FULL POLISH SAE SPLINE COMBINATION RATCHETING WRENCHES**

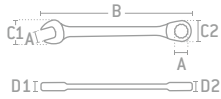

1224CMR

- Made of chrome vanadium steel.
- Exceeds ASME B107.100 standards.
- Nickel-chrome plating
- 15° recovery angle.



ITEM	OPENING SIZE	TOTAL LENGTH (A)	OUTSIDE DIAMETER		HEAD THICKNESS		PACKING	AVAILABLE
			OPEN END (B1)	BOX END (B2)	OPEN END (C1)	BOX END (C2))		
	1/4"							Not available for individual sale
1210CMR	5/16"	5-11/16"	9/32"	3/8"	5/8"	7/32"	1	✓
1212CMR	3/8"	6-1/4"	5/16"	7/16"	11/16"	1/4"	1	✓
1214CMR	7/16"	6-1/2"	15/32"	1/2"	27/32"	7/32"	1	✓
1216CMR	1/2"	7-3/16"	9/16"	9/16"	31/32"	9/32"	1	✓
1218CMR	9/16"	7-1/2"	17/32"	19/32"	1-3/32"	5/16"	1	✓
1220CMR	5/8"	8-7/16"	11/16"	5/8"	1-1/4"	11/32"	1	✓
1222CMR	11/16"	9"	21/32"	11/16"	1-11/32"	11/32"	1	✓
1224CMR	3/4"	9-15/16"	11/16"	3/4"	1-15/32"	3/8"	1	✓

WRENCH SET	
ITEM	JLMC9R
PIECES	9
PACKING	
	1
AVAILABLE	✓

**FULL POLISH METRIC SPLINE COMBINATION RATCHETING WRENCHES**

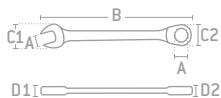

1215MCMR

- Made of chrome vanadium steel.
- Exceeds ASME B107.100 standards.
- Nickel-chrome plating
- 15° recovery angle.



ITEM	OPENING SIZE	TOTAL LENGTH (A)	OUTSIDE DIAMETER		HEAD THICKNESS		PACKING	AVAILABLE
			OPEN END (B1)	BOX END (B2)	OPEN END (C1)	BOX END (C2))		
	8 mm							Not available for individual sale
	9 mm							Not available for individual sale
1210MCMR	10 mm	6-1/4"	5/16"	11/16"	23/32"	5/16"	1	✓
1211MCMR	11 mm	6-1/2"	7/16"	11/16"	27/32"	5/16"	1	✓
1212MCMR	12 mm	6-13/16"	15/32"	25/32"	31/32"	5/16"	1	✓
1213MCMR	13 mm	7-3/16"	1/2"	25/32"	15/16"	5/16"	1	✓
1214MCMR	14 mm	7-1/2"	17/32"	7/8"	1-1/8"	11/32"	1	✓
1215MCMR	15 mm	7-15/16"	17/32"	7/8"	1-3/32"	11/32"	1	✓
	16 mm							Not available for individual sale
	17 mm							Not available for individual sale
	18 mm							Not available for individual sale
	19 mm							Not available for individual sale

WRENCH SET	
ITEM	JLMC12MR
PIECES	12
PACKING	
	1
AVAILABLE	✓

## OPEN-END WRENCHES

### FULL POLISH SAE OPEN-END WRENCHES



STANDARD



URREA GRIP SYSTEM UGS



MIRROR-FINISH

URREA



3039

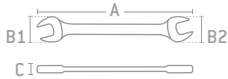

- Thin ends for better access in narrow areas.
- Available in SAE and metric to fit a great variety of nuts and bolts.
- The openings are machined to precision for a perfect fit with nuts and bolts.
- High-quality molybdenum-vanadium steel alloy and controlled thermal-treatment.
- Exceeds ASME B107.100 standard.



\* BULK

### WRENCH SETS

ITEM	3000I	3000G	3000H	3000D	3000C	3000N
PIECES	8	15	10	10	7	5
PACKING						
AVAILABLE	1	1	1	1	1	1

ITEM	OPENING SIZE	TOTAL LENGTH	OUTER DIAMETER		HEAD THICKNESS	UGS	⊞	AVAILABLE
			1	2				
3016	3/16" x 1/4"	3-7/8"	1/2"	29/64"	5/32"	x	6	✓
3018	1/4" x 5/16"	4-1/2"	23/32"	39/64"	5/32"	x	6	✓
3020	5/16" x 3/8"	5-1/8"	13/16"	45/64"	3/16"	x	6	✓
3021	3/8" x 7/16"	5-3/4"	59/64"	13/16"	3/16"	✓	6	✓
3025	7/16" x 1/2"	6-3/8"	1-1/32"	29/32"	7/32"	✓	6	✓
3026	1/2" x 9/16"	7"	1-3/16"	1-1/32"	1/4"	✓	6	✓
3030	9/16" x 5/8"	7-5/8"	1-9/32"	1-5/32"	1/4"	✓	6	✓
3031	5/8" x 3/4"	8-19/32"	1-37/64"	1-9/32"	9/32"	✓	6	✓
3033	19/32" x 11/16"	8-1/4"	1-13/32"	1-9/32"	9/32"	✓	6	✓
3034	5/8" x 11/16"	8-1/4"	1-13/32"	1-9/32"	9/32"	✓	6	✓
3035	11/16" x 3/4"	8-7/8"	1-37/64"	1-13/32"	5/16"	✓	6	✓
3038	13/16" x 3/4"	9-1/2"	1-21/32"	1-37/64"	5/16"	✓	6	✓
3039	3/4" x 7/8"	9-1/2"	1-25/32"	1-37/64"	5/16"	✓	6	✓
3040	13/16" x 7/8"	10-1/8"	1-25/32"	1-21/32"	7/16"	✓	6	✓
3045	15/16" x 1"	11-3/8"	2-1/32"	1-29/32"	7/16"	✓	6	✓
3050	1-1/16" x 1-1/8"	12-5/8"	2-1/4"	2-9/64"	1/2"	✓	1	✓
3051	1-1/16" x 1-1/4"	13-9/16"	2-1/2"	2-9/64"	17/32"	✓	1	✓
3055	1-1/4" x 1-5/16"	14-1/2"	2-5/8"	2-33/64"	9/16"	✓	1	On Request
3060*	1-3/8" x 1-7/16"	15-3/4"	2-7/8"	2-45/64"	21/32"	✓	1	✓
3070*	1-1/2" x 1-5/8"	17"	3-1/4"	2-61/64"	9/16"	✓	1	✓
3075*	1-11/16" x 1-13/16"	18"	3-5/8"	3-23/32"	11/16"	✓	1	✓
3080*	1-7/8" x 2"	18"	4-1/32"	3-23/32"	11/16"	✓	1	✓

### FULL POLISH SAE OPEN-END WRENCHES



STANDARD



MIRROR-FINISH

SURTEK



21



- Made of chrome vanadium steel.
- Comply with ASME B107.100 standard.
- Nickel-chrome plating



ITEM	OPENING SIZE	TOTAL LENGTH (A)	OUTER DIAMETER		HEAD THICKNESS (C)	⊞	AVAILABLE
			B1	B2			
21	1/4" x 5/16"	4-19/32"	0.0094	1/64"	0.0071	6	✓
24	7/16" x 1/2"	5-29/32"	1/64"	1/64"	0.0094	6	✓
35	15/16" x 1"	10-1/8"	1/32"	1/32"	1/64"	6	✓



## OPEN-END WRENCHES

### FULL POLISH METRIC OPEN-END WRENCHES



METRIC



URREA GRIP SYSTEM UGS



CHROME PLATED

URREA

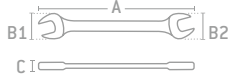

31922

- Thin ends for better access in narrow areas.
- Available in SAE and metric to fit a great variety of nuts and bolts.
- The openings are machined to precision for a perfect fit with nuts and bolts.
- High-quality molybdenum-vanadium steel alloy and controlled thermal-treatment.
- Exceeds ASME B107.100 standard.



ITEM	OPENING SIZE	TOTAL LENGTH	OUTER DIAMETER		HEAD THICKNESS	UGS	BULK	AVAILABLE	WRENCH SETS			
			1	2					3000IM	30000A	30000RM	30000R
30607	6 x 7 mm	4-1/2"	23/32"	19/32"	3/16"	×	6	✓	•	•	•	•
30809	8 x 9 mm	5-1/8"	13/16"	11/16"	3/16"	×	6	✓	•	•	•	•
30810	8 x 10 mm	5-1/8"	13/16"	11/16"	3/16"	✓	6	✓	•	•	•	•
30910	9 x 10 mm	5-1/8"	13/16"	11/16"	3/16"	✓	6	✓	•	•	•	•
31011	10 x 11 mm	5-3/4"	29/32"	13/16"	7/32"	✓	6	✓	•	•	•	•
31012	10 x 12 mm	5-3/4"	29/32"	13/16"	7/32"	✓	6	✓	•	•	•	•
31213	12 x 13 mm	6-3/8"	1-1/32"	29/32"	7/32"	✓	6	✓	•	•	•	•
31415	14 x 15 mm	7-5/8"	1-9/32"	1-5/32"	1/4"	✓	6	✓	•	•	•	•
31417	14 x 17 mm	7-5/8"	1-9/32"	1-5/32"	1/4"	✓	6	✓	•	•	•	•
31617	16 x 17 mm	8-1/4"	1-13/32"	1-9/32"	9/32"	✓	6	✓	•	•	•	•
31819	18 x 19 mm	8-7/8"	1-9/16"	1-13/32"	9/32"	✓	6	✓	•	•	•	•
31922	19 x 22 mm	9-1/2"	1-25/32"	1-9/16"	11/32"	✓	6	✓	•	•	•	•
32021	20 x 21 mm	9-3/4"	1-25/32"	1-9/16"	11/32"	✓	6	✓	•	•	•	•
32122	21 x 22 mm	10-1/8"	1-25/32"	1-21/32"	11/32"	✓	6	✓	•	•	•	•
32427	24 x 27 mm	11-3/8"	2-1/32"	1-29/32"	3/8"	✓	6	✓	•	•	•	•
32528	25 x 28 mm	12-5/8"	2-1/4"	2-1/8"	13/32"	✓	6	✓	•	•	•	•
32732	27 x 32 mm	13-9/16"	2-1/2"	2-1/8"	7/16"	✓	6	✓	•	•	•	•
33236*	32 x 36 mm	15-3/4"	2-7/8"	2-11/16"	17/32"	✓	6	✓	•	•	•	•
33641*	36 x 41 mm	17"	3-1/4"	2-15/16"	9/16"	✓	6	✓	•	•	•	•

### FULL POLISH METRIC OPEN-END WRENCHES



METRIC



MIRROR-FINISH

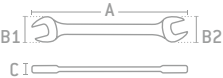

51819

- Made of chrome vanadium steel.
- Comply with ASME B107.100 standard.
- Nickel-chrome plating



ITEM	OPENING SIZE	TOTAL LENGTH (A)	OUTER DIAMETER		HEAD THICKNESS (C)	⊞	AVAILABLE
			B1	B2			
50607	6 mm x 7 mm	4-19/32"	35/64"	21/32"	11/64"	6	✓
50809	8 mm x 9 mm	5"	21/32"	25/32"	13/64"	6	✓
51011	10 mm x 11 mm	5-15/64"	25/32"	7/8"	13/64"	6	✓
51213	12 mm x 13 mm	5-29/32"	7/8"	1-1/32"	15/64"	6	✓
51415	14 mm x 15 mm	6-15/16"	1-5/32"	1-9/32"	1/4"	6	✓
51617	16 mm x 17 mm	7-3/4"	1-9/32"	1-3/8"	17/64"	6	✓
51819	18 mm x 19 mm	8"	1-25/64"	1-1/2"	9/32"	6	✓

### THIN-HEAD OPEN-END WRENCH



METRIC



BULK

- Made of chrome vanadium steel.
- Comply with ASME B107.100 standard.
- Nickel-chrome plating

ITEM	OPENING SIZE	TOTAL LENGTH	HEAD THICKNESS	⊞	AVAILABLE
URR2284011	21 mm, x 24 mm	9-1/2"	5/32"	6	On Request

## BOX WRENCHES

# FULL POLISH 12-POINT 15° BOX-END WRENCHES.

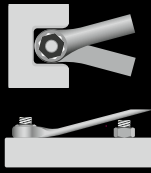

- 30° recuperation angle.
- Oval handle for a more comfortable grip.
- 15° offset angle facilitates performance in difficult areas.

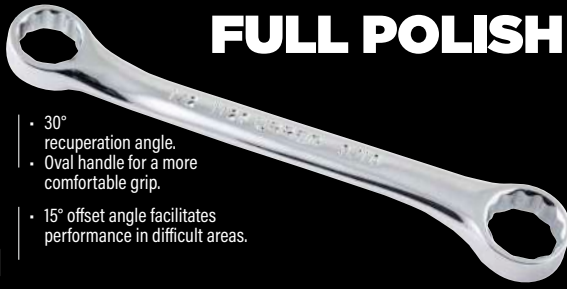

Nickel-chrome finish prevents corrosion and full-polish finish makes easy to clean.

MECHANICAL WRENCHES

### FULL POLISH SAE 15° BOX WRENCHES 12 POINT

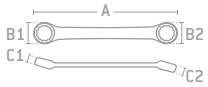

1139

- Made of chrome vanadium steel.
- Exceeds ASME B107.100 standard.
- Nickel-chrome plating.
- Precision-broached jaws for a perfect grip on nuts or bolts.
- Slim jaws for better access in tight spaces.



ITEM	OPENING SIZE	TOTAL LENGTH (A)	OUTER DIAMETER		HEAD THICKNESS		PKGS	AVAILABLE	WRENCH SETS		
			B1	B2	C1	C2			1100I	1100D	1100H
1120	5/16" x 3/8"	4-1/4"	15/32"	15/32"	9/32"	1/4"	6	✓	•	•	•
1122	3/8" x 7/16"	4-5/8"	41/64"	9/16"	5/16"	9/32"	6	✓	•	•	•
1125	7/16" x 1/2"	5"	23/32"	41/64"	21/64"	5/16"	6	✓	•	•	•
1126	1/2" x 9/16"	5-3/8"	51/64"	23/32"	23/64"	21/64"	6	✓	•	•	•
1130	9/16" x 5/8"	5-3/4"	57/64"	51/64"	13/32"	11/32"	6	✓	•	•	•
1134	5/8" x 11/16"	10-5/8"	63/64"	57/64"	7/16"	13/32"	6	✓	•	•	•
1135	11/16" x 3/4"	11-1/4"	1-1/16"	31/32"	15/32"	7/16"	6	✓	•	•	•
1139	3/4" x 7/8"	13-1/8"	1-15/64"	1 1/16"	33/64"	15/32"	6	✓	•	•	•
1140	13/16" x 7/8"	13-7/8"	1-15/64"	1 5/32"	17/32"	1/2"	6	✓	•	•	•
1145	15/16" x 1"	15-1/2"	1-27/64"	1-21/64"	9/16"	9/16"	6	✓	•	•	•
1150	1-1/16" x 1-1/8"	17-1/4"	1-37/64"	1-1/2"	41/64"	19/32"	6	✓	•	•	•
1151	1-1/16" x 1-1/4"	18-1/4"	1-47/64"	1-1/2"	43/64"	19/32"	6	✓	•	•	•
1155	1-1/4" x 1-5/16"	19-1/4"	1-13/16"	1-3/4"	45/64"	11/16"	6	✓	•	•	•
1160	1-1/4" x 1-3/8"	20-1/4"	1-29/32"	1-3/4"	23/32"	11/16"	6	✓	•	•	•
1162*	1-7/16" x 1-1/2"	22-1/4"	2-1/16"	1-63/64"	51/64"	25/32"	6	✓	•	•	•
1164*	1-5/8" x 1-11/16"	24-1/2"	2-25/64"	2-25/64"	21/32"	7/8"	6	✓	•	•	•



### FULL POLISH METRIC 15° BOX WRENCHES 12 POINT

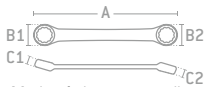

1065M

- Made of chrome vanadium steel.
- Exceeds ASME B107.100 standard.
- Nickel-chrome plating.
- Precision-broached jaws for a perfect grip on nuts or bolts.
- Slim jaws for better access in tight spaces.



ITEM	OPENING SIZE	TOTAL LENGTH (A)	OUTER DIAMETER		HEAD THICKNESS		PKGS	AVAILABLE	WRENCH SETS		
			B1	B2	C1	C2			1100IM	1100SM	1100DM
1051M	8 x 9 mm	4-1/4"	17/32"	15/32"	9/32"	1/4"	6	✓	•	•	•
1052M	8 x 10 mm	4-5/8"	5/8"	9/16"	5/16"	9/32"	6	✓	•	•	•
1053M	10 x 11 mm	4-5/8"	5/8"	9/16"	5/16"	9/32"	6	✓	•	•	•
1054M	11 x 13 mm	5"	11/16"	5/8"	5/16"	5/16"	6	✓	•	•	•
1057M	12 x 13 mm	5-3/8"	25/32"	23/32"	11/32"	5/16"	6	✓	•	•	•
1061M	14 x 15 mm	5-3/4"	29/32"	25/32"	13/32"	11/32"	6	✓	•	•	•
1064M	16 x 18 mm	10-5/8"	1"	7/8"	7/16"	13/32"	6	✓	•	•	•
1065M	17 x 19 mm	11-1/4"	1-1/16"	31/32"	7/16"	7/16"	6	✓	•	•	•
1072M	21 x 24 mm	13-7/8"	1-11/32"	1-1/4"	17/32"	1/2"	6	✓	•	•	•
1073M	22 x 24 mm	13-7/8"	1-11/32"	1-1/4"	17/32"	1/2"	6	✓	•	•	•
1077M	27 x 30 mm	17-1/4"	1-9/16"	1-1/2"	5/8"	19/32"	6	✓	•	•	•
1079M	30 x 32 mm	19-1/4"	1-13/16"	1-3/4"	11/16"	21/32"	6	✓	•	•	•



**BOX WRENCHES**

# FULL POLISH 12-POINT 45° BOX-END WRENCHES.



- 45° offset angle facilitates performance in difficult areas.
- Oval handle for a more comfortable grip.



- Nickel-chrome finish prevents corrosion and full-polish finish makes easy to clean.

**FULL POLISH SAE 45° BOX WRENCHES 12 POINT**



STANDARD



MIRROR-FINISH

URREA



MECHANICAL WRENCHES

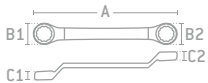

8181

- Made of chrome vanadium steel.
- Exceeds ASME B107.100 standard.
- Nickel-chrome plating.
- Precision-broached jaws for a perfect grip on nuts or bolts.
- Slim jaws for better access in tight spaces.
- 45° angle design for access to hard-to-reach nuts or bolts.



ITEM	OPENING SIZE	TOTAL LENGTH (A)	OUTER DIAMETER		HEAD THICKNESS		C1	C2	☞	AVAILABLE
			B1	B2	C1	C2				
8180	3/8" x 7/16"	7-13/16"	25/32"	11/16"	5/16"	3/16"	6	✓	✓	•
8181	1/2" x 9/16"	9-1/16"	27/32"	3/4"	5/16"	5/16"	6	✓	✓	•
8182	5/8" x 11/16"	10-5/16"	1"	29/32"	13/32"	11/32"	6	✓	✓	•
8183	25/32" x 13/16"	11-1/2"	1-1/8"	1-1/8"	7/16"	7/16"	6	✓	✓	•
8184	3/4" x 7/8"	12-3/4"	1-9/32"	1-3/32"	1/2"	15/32"	6	✓	✓	•
8185	15/16" x 1"	14-1/16"	1-13/32"	1-11/32"	9/16"	9/16"	6	✓	✓	•
8186	1-1/16" x 1-1/8"	15-1/32"	1-17/32"	1-5/8"	11/16"	5/8"	6	✓	✓	•

WRENCH SET	
ITEM	8100C
PIECES	6
PACKING	
☞	1
AVAILABLE	✓

**FULL POLISH SAE 45° BOX WRENCHES 12 POINT**



INCHES



MIRROR-FINISH

SURTEK



829

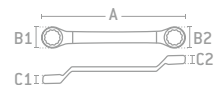

- Made of chrome vanadium steel.
- Comply with ASME B107.100 standard.
- 45° angle design for access to hard-to-reach nuts or bolts
- Nickel-chrome plating



ITEM	OPENING SIZE	TOTAL LENGTH (A)	OUTER DIAMETER		HEAD THICKNESS		C1	C2	☞	AVAILABLE
			B1	B2	C1	C2				
823	3/8" x 7/16"	7-3/4"	37/64"	21/32"	19/64"	11/32"	6	✓	✓	•
825	1/2" x 9/16"	9-3/64"	3/4"	53/64"	3/8"	27/64"	6	✓	✓	•
829	5/8" x 11/16"	10-15/64"	59/64"	1-1/64"	7/16"	15/32"	6	✓	✓	•
830	25/32" x 13/16"	11-1/2"	1-9/64"	1-3/16"	1/2"	17/32"	6	✓	✓	•
831	3/4" x 7/8"	12-3/4"	1-3/32"	1-17/64"	1/2"	9/16"	6	✓	✓	•
832	15/16" x 1"	10-1/8"	1-23/64"	1-29/64"	19/32"	19/32"	6	✓	✓	•
833	1-1/16" x 1-1/8"	15"	1-17/32"	1-39/64"	5/8"	21/32"	6	✓	✓	•

## BOX WRENCHES

### FULL POLISH METRIC 45° BOX WRENCHES 12 POINT



81314

- Made of chrome vanadium steel.
- Exceeds ASME B107.100 standard.
- Nickel-chrome plating.
- Precision-broached jaws for a perfect grip on nuts or bolts.
- Slim jaws for better access in tight spaces.
- 45° angle design for access to hard-to-reach nuts or bolts.



ITEM	OPENING SIZE	TOTAL LENGTH (A)	OUTER DIAMETER		HEAD THICKNESS		AVAILABLE
			B1	B2	C1	C2	
80911	9 x 11 mm	7-3/4"	5/8"	11/16"	5/16"	1/4"	6 ✓
81011	10 x 11 mm	7-3/4"	5/8"	9/16"	5/16"	1/4"	6 ✓
81213	12 x 13 mm	9"	7/8"	3/4"	5/16"	5/16"	6 ✓
81215	12 x 15 mm	9"	7/8"	3/4"	5/16"	5/16"	6 ✓
81314	13 x 14 mm	9"	7/8"	3/4"	5/16"	5/16"	6 ✓
81415	14 x 15 mm	9"	7/8"	3/4"	5/16"	5/16"	6 ✓
81516	15 x 16 mm	9"	7/8"	3/4"	5/16"	5/16"	6 ✓
81617	16 x 17 mm	10-5/16"	1"	15/16"	3/8"	3/8"	6 ✓
81922	19 x 22 mm	12-3/4"	1-1/8"	1-1/8"	1/2"	7/16"	6 ✓
82426	24 x 26 mm	14"	1-1/8"	1-3/8"	9/16"	9/16"	6 ✓

WRENCH SET	
ITEM	8100CM
PIECES	6
PACKING	
AVAILABLE	✓

### FULL POLISH METRIC 45° BOX WRENCHES 12 POINT



851314

- Made of chrome vanadium steel.
- Comply with ASME B107.100 standard.
- 45° angle design for access to hard-to-reach nuts or bolts.
- Nickel-chrome plating



ITEM	OPENING SIZE	TOTAL LENGTH (A)	OUTER DIAMETER		HEAD THICKNESS		AVAILABLE
			B1	B2	C1	C2	
851011	10 mm x 11 mm	7-3/4"	4/7"	2/3"	2/7"	1/3"	6 ✓
851314	13 mm x 14 mm	10-15/64"	3/4"	6/7"	1/3"	1/3"	6 ✓
851617	16 mm x 17 mm	10-15/64"	1"	1/9"	3/7"	1/2"	6 ✓
851922	19 mm x 22 mm	12-3/4"	1 1/9"	1 1/4"	1/2"	5/9"	6 ✓
852426	24 mm x 26 mm	10-1/8"	1 1/3"	1 4/9"	1/2"	1/2"	6 ✓

## OBSTRUCTION BOX WRENCHES

### OBSTRUCTION SAE BOX WRENCHES 12 POINT

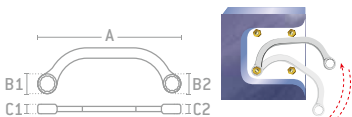

1730

- Made of chrome vanadium steel.
- Exceeds ASME B107.100 standard.
- Heat-treated to provide high performance and protect against corrosion.
- Designed for applications with limited access or obstructed areas.



ITEM	OPENING SIZE	TOTAL LENGTH (A)	OUTER DIAMETER		HEAD THICKNESS		AVAILABLE
			B1	B2	C1	C2	
1725	7/16" x 1/2"	5 7/8"	49/64"	11/16"	23/64"	23/64"	6 ✓
1730	9/16" x 5/8"	6-11/16"	15/16"	55/64"	3/8"	3/8"	6 ✓
1731	5/8" x 3/4"	7-11/16"	1-1/16"	15/16"	13/32"	13/32"	6 ✓

**BULK**

WRENCH SET	
ITEM	1700A
PIECES	3
PACKING	
AVAILABLE	✓

## OBSTRUCTION BOX WRENCHES

### OBSTRUCTION METRIC BOX WRENCHES 12 POINT



URREA

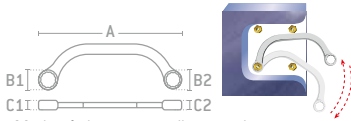

171012

- Made of chrome vanadium steel.
- Exceeds ASME B107.100 standard.
- Heat-treated to provide high performance and protect against corrosion.
- Designed for applications with limited access or obstructed areas.

ITEM	OPENING SIZE	TOTAL LENGTH (A)	OUTER DIAMETER		HEAD THICKNESS		⊞	WRENCHES SET	
			B1	B2	C1	C2		1700CM	1700AM
171012	10 x 12 mm	5-55/64"	49/64"	11/16"	23/64"	23/64"	6	•	•
171113	11 x 13 mm	5-55/64"	49/64"	11/16"	23/64"	23/64"	6	•	•
171415	14 x 15 mm	6-45/64"	15/16"	4 51/64"	3/8"	3/8"	6	•	•
171619	16 x 19 mm	7-11/16"	1-1/8"	15/16"	13/32"	13/32"	6	•	•
171718	17 x 18 mm	7-11/16"	1-1/8"	15/16"	13/32"	13/32"	6	•	•

## BOX RATCHETING WRENCHES

### FULL POLISH SAE SINGLE BOX RATCHETING WRENCHES 12 POINT



URREA



WER46

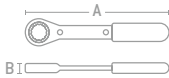

- Made of chrome vanadium steel.
- Nickel-chrome plating
- Slim body formed by two outer plates and a solid inner core.
- Mechanism heat-treated to ensure a long service life.

BULK

ITEM	OPENING SIZE	TOTAL LENGTH (A)	HEAD THICKNESS (B)	⊞	AVAILABLE
WER46	1-7-16"	15-1/2"	5/8"	1	On Request
WER48	1-1/2"	15-1/2"	5/8"	1	✓
WER54	1-11-16"	19"	5/8"	1	On Request
WER60	1-7/8"	19"	5/8"	1	✓

### FULL POLISH METRIC SINGLE BOX RATCHETING WRENCHES 12 POINT



URREA



WER24M

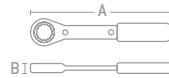

- Made of chrome vanadium steel.
- Nickel-chrome plating
- Slim body formed by two outer plates and a solid inner core.
- Mechanism heat-treated to ensure a long service life.

BULK

ITEM	OPENING SIZE	TOTAL LENGTH (A)	HEAD THICKNESS (B)	⊞	AVAILABLE
WER24M	24 mm	12"	5/8"	1	✓
WER30M	30 mm	12"	5/8"	1	✓
WER32M	32 mm	15-1/2"	5/8"	1	On Request
WER36M	36 mm	15-1/2"	5/8"	1	On Request

### FULL POLISH SAE BOX RATCHETING WRENCH SET 12 POINT



URREA



MIRROR-FINISH

4 PIECES

Sizes  
5/16" x 3/8"  
7/16" x 1/2"  
9/16" x 5/8"  
11/16" x 3/4"



- Exceeds ASME B107.100 standard.

ITEM	PIECES	⊞	AVAILABLE
11M4	4	1	✓

### FULL POLISH METRIC BOX RATCHETING WRENCH SET 12 POINT



URREA



MIRROR-FINISH

6 PIECES

Sizes  
8 mm x 9 mm  
10 mm x 11 mm  
12 mm x 13 mm  
14 mm x 15 mm  
16 mm x 18 mm  
17 mm x 19 mm



- Exceeds ASME B107.100 standard.

ITEM	PIECES	⊞	AVAILABLE
11M6M	6	1	✓

# 05 MECHANICAL WRENCHES

## BOX RATCHETING WRENCHES

### 4 IN 1 SAE BOX RATCHETING REVERSIBLE WRENCH SET 12 POINT

HEAVY DUTY STANDARD 12 RATCHET SYSTEM REVERSIBLE RATCHETING



**2 PIECES**

Sizes
5/16"
3/8"
7/16"
1/2"
9/16"
5/8"
11/16"
3/4"



- Exceeds ASME B107.100 standard.
- Electronic coating for ultimate rust prevention.
- Each wrench features four ratcheting box end size, making the tools great for compact and on-the-go tool kits.



ITEM	PIECES	AVAIL.
1170A	2	1 ✓

### 4 IN 1 METRIC BOX RATCHETING REVERSIBLE WRENCH SET 12 POINT

HEAVY DUTY METRIC 12 RATCHET SYSTEM REVERSIBLE RATCHETING



**2 PIECES**

Sizes
8 mm
10 mm
12 mm
13 mm
16 mm
17 mm
18 mm
19 mm



- Exceeds ASME B107.100 standard.
- Electronic coating for ultimate rust prevention.
- Each wrench features four ratcheting box end size, making the tools great for compact and on-the-go tool kits.



ITEM	PIECES	AVAIL.
1170M	2	1 ✓

### FULL POLISH SAE FLAT BOX RATCHETING WRENCHES

HEAVY DUTY STANDARD 12 SUPER DRIVE RATCHET SYSTEM



- Exceeds ASME B107.100 standard.
- Nickel-chrome plating.
- Mechanism heat-treated to ensure a long service life.

ITEM	OPENING SIZE	TOTAL LENGTH (A)	OUTSIDE DIAMETER		HEAD THICKNESS (C)	AVAIL.	WRENCH SET	
			B1	B2			ITEM	PIECES
1191	1/4" x 5/16"	4-1/2"	43/64"	19/32"	3/8"	6 ✓	1190A	5
1192	3/8" x 7/16"	5-1/2"	57/64"	51/64"	3/8"	6 ✓		1 ✓
1193	1/2" x 9/16"	6-7/8"	1-5/32"	1-1/64"	1/2"	6 ✓		
1194	5/8" x 11/16"	8-1/8"	1-7/16"	1-19/64"	1/2"	6 ✓		
1195	5/8" x 3/4"	8-1/8"	1-19/64"	1-7/16"	1/2"	6 ✓		
1197	3/4" x 9/16"	8-3/16"	1-7/16"	1-19/64"	1/2"	6 ✓		
1196	3/4" x 7/8"	9-1/4"	1-37/64"	1-13/32"	1/2"	6 ✓		

### FULL POLISH METRIC FLAT BOX RATCHETING WRENCHES

HEAVY DUTY METRIC 12 6 SUPER DRIVE SUPER DRIVE RATCHET SYSTEM



- Exceeds ASME B107.100 standard.
- Nickel-chrome plating.
- Mechanism heat-treated to ensure a long service life.

ITEM	OPENING SIZE	TOTAL LENGTH (A)	OUTSIDE DIAMETER		HEAD THICKNESS (C)	AVAIL.	WRENCH SET	
			B1	B2			ITEM	PIECES
1191M	7 x 8 mm	4-1/2"	21/32"	19/32"	3/8"	6 ✓	1190M	5
1192M	9 x 10 mm	5-1/2"	7/8"	25/32"	3/8"	6 ✓		1 ✓
1192MA	10 x 11 mm	6-7/8"	1-5/32"	1"	1/2"	6 ✓		
1192MB	10 x 13 mm	6-7/8"	1-5/32"	1"	1/2"	6 ✓		
1193M	11 x 12 mm	6-7/8"	1-5/32"	1"	1/2"	6 ✓		
1194M	13 x 14 mm	8-1/8"	1-5/32"	1"	1/2"	6 ✓		
1195M	15 x 17 mm	8-3/16"	1-7/16"	1-9/32"	1/2"	6 ✓		
1196M	16 x 18 mm	8-1/8"	1-7/16"	1-9/32"	1/2"	6 ✓		
1197M	19 x 21 mm	9-1/4"	1-9/16"	1-13/32"	1/2"	6 ✓		

MECHANICAL WRENCHES

## BOX RATCHETING WRENCHES

### FULL POLISH SAE OFFSET BOX RATCHETING WRENCHES



URREA

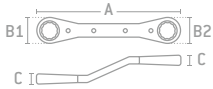

1183

- Exceeds ASME B107.100 standard.
- Ratcheting mechanism allows repositioning the wrench without disengaging it from nut or bolt
- Nickel-chrome plating
- Slim body constructed with two outer plates and a solid inner core
- Offset at 15°



ITEM	OPENING SIZE	TOTAL LENGTH (A)	OUTSIDE DIAMETER		HEAD THICKNESS (C)	BULK	AVAILABLE	WRENCH SET	
			B1	B2				ITEM	PIECES
1181	1/4" x 5/16"	4-1/4"	19/32"	43/64"	3/8"	6	✓	1180A	5
1182	3/8" x 7/16"	5-7/16"	51/64"	57/64"	3/8"	6	✓		
1183	1/2" x 9/16"	6-3/4"	1-1/64"	1-5/32"	1/2"	6	✓		
1184	5/8" x 11/16"	8"	1-19/64"	1-7/16"	1/2"	6	✓		
1186	5/8" x 3/4"	8"	1-19/64"	1-7/16"	1/2"	6	✓		
1185	3/4" x 7/8"	9-1/8"	1-13/32"	1-37/64"	1/2"	6	✓		

### FULL POLISH METRIC OFFSET BOX RATCHETING WRENCHES



URREA

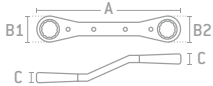

1183M

- Exceeds ASME B107.100 standard.
- Ratcheting mechanism allows repositioning the wrench without disengaging it from the nut or bolt
- Nickel-chrome plating
- Slim body constructed with two outer plates and a solid inner core
- Offset at 15°



ITEM	mm	OPENING SIZE	TOTAL LENGTH (A)	OUTSIDE DIAMETER		HEAD THICKNESS (C)	BULK	AVAILABLE	WRENCH SET	
				B1	B2				ITEM	PIECES
1181M	•	7 x 8 mm	4-1/4"	21/32"	19/32"	3/8"	6	✓	1180M	7
1182M	•	9 x 10 mm	5-7/16"	7/8"	25/32"	3/8"	6	✓		
1183M	•	11 x 12 mm	6-3/4"	1-5/32"	1"	1/2"	6	✓		
1184M	•	13 x 14 mm	6-3/4"	1-5/32"	1"	1/2"	6	✓		
1185M	•	15 x 17 mm	8"	1-7/16"	1-9/32"	1/2"	6	✓		
1186M	•	16 x 18 mm	8"	1-7/16"	1-9/32"	1/2"	6	✓		
1187M	•	19 x 21 mm	9-1/8"	1-9/16"	1-13/32"	1/2"	6	✓		

### SAE REFRIGERATION BOX RATCHETING WRENCH



URREA

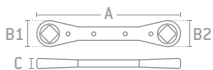

- Exceeds ASME B107.100 standard.
- Ratcheting mechanism allows repositioning the wrench without disengaging it from nut or bolt.
- Nickel-chrome plating.
- Slim body constructed with two outer plates and a solid inner core.
- Offset at 15°.
- Features four square drive openings.

BULK

ITEM	OPENING SIZE	TOTAL LENGTH (A)	OUTSIDE DIAMETER		HEAD THICKNESS (C)	BULK	AVAILABLE
			B1	B2			
1180	1/4"-3/16" x 3/8"-5/16"	4-1/2"	9/16"	19/32"	3/8"	6	✓

## FLARE NUT WRENCHES

# SPECIALIZED WRENCHES.

MECHANICAL WRENCHES



### FULL POLISH SAE FLARE NUT WRENCHES



3764



- Ideal for tightening or loosening pipe fittings made of soft metals such as brass, copper, and aluminum
- Open ends designed to facilitate work on pipe nuts
- Exceeds ASME B107.100 standard.



ITEM	OPENING SIZE	TOTAL LENGTH (A)	OUTER DIAMETER		HEAD THICKNESS		PKT	AVAILABLE	WRENCH SET	
			B1	B2	C1	C2			ITEM	PIECES
3764	3/8" x 7/16"	6-5/8"	13/16"	59/64"	23/64"	13/32"	6	✓	3760	3
3768	1/2" x 9/16"	7-9/16"	1-1/64"	1-3/32"	13/32"	15/32"	6	✓		
3772	5/8" x 11/16"	8-13/16"	1-1/8"	1-15/64"	29/64"	33/64"	6	✓		

### FULL POLISH METRIC FLARE NUT WRENCHES



3710M



- Ideal for tightening or loosening pipe fittings made of soft metals such as brass, copper, and aluminum
- Open ends designed to facilitate work on pipe nuts
- Exceeds ASME B107.100 standard.



ITEM	OPENING SIZE	TOTAL LENGTH (A)	OUTER DIAMETER		HEAD THICKNESS		PKT	AVAILABLE	WRENCH SET	
			B1	B2	C1	C2			ITEM	PIECES
3709M	9 x 11 mm	6-5/8"	13/16"	59/64"	23/64"	13/32"	6	✓	3700M	5
3710M	10 x 12 mm	6-5/8"	13/16"	59/64"	23/64"	13/32"	6	✓		
3713M	13 x 14 mm	7-9/16"	1-1/64"	1-3/32"	13/32"	15/32"	6	✓		
3715M	15 x 17 mm	8-11/16"	1-1/8"	1-15/64"	15/32"	33/64"	6	✓		
3716M	16 x 18 mm	8-11/16"	1-1/8"	1-15/64"	15/32"	33/64"	6	✓		

### BLACK SAE FLARE NUT WRENCHES



3818

- Quick-Release system brings great speed on work by using the switch, the user will not need to remove the wrench head from the workpiece.
- Designed for use on 6 and 12 point tube fittings, fasteners, valves and compression fittings.
- Black finish oil-based non-reflective, corrosion-resistant.
- Exceeds ASME B107.100 standard.



ITEM	OPENING SIZE	LENGTH (A)	PKT	AVAILABLE
3812	3/8"	5-1/4"	1	✓
3818	9/16"	7 1/4"	1	✓
3820	5/8"	7 1/4"	1	✓
3824	3/4"	7 1/4"	1	✓
3828	7/8"	9-1/4"	1	On Request

### BLACK SPANNER WRENCH WITH PIN

#### BLACK SPANNER WRENCH WITH PIN

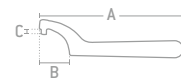

C460 - URREA - MEXICO

- Phosphatized finish protects against corrosion and prevents the shedding of coating particles.
- Pin for safe adjustments.
- Manufactured with high-quality steel alloy.



ITEM	OPENING DIMENSION	TOTAL LENGTH (A)	PIN DIAMETER (B)	PIN LENGTH (C)	PKT	AVAILABLE
C460	3"	8"	5/16"	9/32"	1	✓



**SERVICE WRENCHES**

**SATIN-FINISH SAE SERVICE WRENCHES**

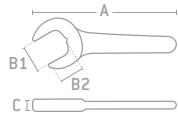

- 30° angled open end.
- Satin finish that protects against corrosion.
- Ideal for low-torque applications such as counter-lever systems
- Slim design allows adjustments in hard-to-reach areas
- Exceeds ASME B107.100 standard

**WRENCH SETS**

	<b>U3500B</b>	<b>U3500A</b>
<b>ITEM</b>	<b>13</b>	<b>13</b>
<b>PIECES</b>		
<b>PACKING</b>		

**BULK**

ITEM	OPENING SIZE	TOTAL LENGTH (A)	OUTER DIAMETER (B1)	JAW DEPTH (B2)	HEAD THICKNESS (C)	UGS	⊞	AVAILABLE
U3524	3/4"	6-5/8"	1-21/32"	57/64"	1/4"	✓	6	✓
U3526	13/16"	6-5/8"	1-21/32"	57/64"	1/4"	✓	6	✓
U3528	7/8"	6-5/8"	1-21/32"	29/32"	1/4"	✓	6	✓
U3530	15/16"	6-7/8"	1-7/8"	1-1/32"	1/4"	✓	6	✓
U3532	1"	6-7/8"	1-7/8"	1-1/32"	1/4"	✓	6	✓
U3534	1-1/16"	6-7/8"	1-7/8"	1-1/32"	1/4"	✓	6	✓
U3536	1-1/8"	7"	2-1/16"	1-1/16"	1/4"	✓	6	✓
U3538	1-3/16"	7"	2-1/16"	1-1/16"	1/4"	✓	6	✓
U3540	1-1/4"	7"	2-1/16"	1-3/32"	1/4"	✓	6	✓
U3542	1-5/16"	7-5/8"	2-1/2"	1-9/32"	9/32"	✓	1	✓
U3544	1-3/8"	7-5/8"	2-1/2"	1-9/32"	9/32"	✓	1	✓
U3546	1-7/16"	7-5/8"	2-1/2"	1-5/16"	9/32"	✓	1	✓
U3548	1-1/2"	7-5/8"	2-5/8"	1-5/16"	9/32"	✓	1	✓
U3550	1-9/16"	7-5/8"	2-5/8"	1-11/32"	9/32"	✓	1	✓
U3552	1-5/8"	7-5/8"	2-5/8"	1-11/32"	9/32"	✓	1	✓
U3554	1-11/16"	7-5/8"	2-5/8"	1-11/32"	9/32"	✓	1	✓
U3556	1-3/4"	8-1/2"	3-1/8"	1-23/32"	5/16"	✓	1	✓
U3558	1-13/16"	8-1/2"	3-1/8"	1-23/32"	5/16"	✓	1	✓
U3560	1-7/8"	8-1/2"	3-1/8"	1-3/4"	5/16"	✓	1	✓
U3562	1-15/16"	8-1/2"	3-1/8"	1-15/16"	5/16"	✓	1	✓
U3564	2"	8-1/2"	3-1/2"	1-15/16"	5/16"	✓	1	✓
U3568	2-1/8"	8-1/2"	3-1/2"	1-15/16"	5/16"	✗	1	✓
U3572	2-1/4"	8-1/2"	3-1/2"	1-15/16"	5/16"	✗	1	✓
U3576	2-3/8"	8-1/2"	3-1/2"	1-15/16"	5/16"	✗	1	✓
U3580	2-1/2"	8-1/2"	3-1/2"	1-31/32"	5/16"	✗	1	✓
U3582	2-9/16"	8-1/2"	3-1/2"	1-31/32"	5/16"	✗	1	✓

**SATIN-FINISH METRIC SERVICE WRENCHES**

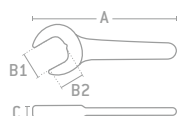

- 30° angled open end.
- Satin finish that protects against corrosion.
- Ideal for low-torque applications such as counter-lever systems
- Slim design allows adjustments in hard-to-reach areas
- Exceeds ASME B107.100 standard

**WRENCH SETS**

	<b>U3500BM</b>	<b>U3500AM</b>
<b>ITEM</b>	<b>6</b>	<b>10</b>
<b>PIECES</b>		
<b>PACKING</b>		

**BULK**

ITEM	OPENING SIZE	TOTAL LENGTH (A)	OUTER DIAMETER (B1)	JAW DEPTH (B2)	HEAD THICKNESS (C)	UGS	⊞	AVAILABLE
U3519M	19 mm	6-5/8"	1-21/32"	57/64"	1/4"	✓	6	✓
U3521M	21 mm	6-5/8"	1-21/32"	29/32"	1/4"	✓	6	✓
U3522M	22 mm	6-5/8"	1-21/32"	29/32"	1/4"	✓	6	✓
U3524M	24 mm	6-7/8"	1-7/8"	1-1/32"	1/4"	✓	6	✓
U3527M	27 mm	6-7/8"	1-7/8"	1-1/16"	1/4"	✓	6	✓
U3530M	30 mm	7"	2-1/16"	1-3/32"	1/4"	✓	6	✓
U3532M	32 mm	7"	2-1/16"	1-3/32"	1/4"	✓	6	✓
U3536M	36 mm	7-5/8"	2-1/2"	1-9/32"	9/32"	✓	1	✓
U3537M	37 mm	7-5/8"	2-1/2"	1-5/16"	9/32"	✓	1	✓
U3538M	38 mm	7-5/8"	2-1/2"	1-5/16"	9/32"	✓	1	✓
U3541M	41 mm	7-5/8"	2-5/8"	1-11/32"	9/32"	✓	1	✓
U3546M	46 mm	8-1/2"	3-1/8"	1-23/32"	5/16"	✗	1	✓
U3550M	50 mm	8-1/2"	3-1/8"	1-3/4"	5/16"	✗	1	✓
U3555M	55 mm	8-1/2"	3-1/2"	1-15/16"	5/16"	✗	1	✓
U3560M	60 mm	8-1/2"	3-1/2"	1-31/32"	5/16"	✗	1	✓
U3565M	65 mm	8-1/2"	3-1/2"	1-31/32"	5/16"	✗	1	✓

## HIGH-LEVERAGE WRENCHES

MECHANICAL WRENCHES

# HIGH LEVERAGE WRENCHES.



## UAS URREA ASSEMBLING SYSTEM

Urrea Assembling System wrenches allow work in vertical and horizontal positions in hard-to-reach places. Their design enables optimal torque while minimizing the risk of user injury, making them very safe, high-leverage wrenches.

INTERNATIONAL PATENT: PCT/MX2008/000125



### HIGH LEVERAGE

The extension bar provides greater leverage.

Phosphatized finish protects against corrosion.

Anti-slip grip provides better control during use.

### SPUD WRENCHES



### OFFSET WRENCHES



### FLAT WRENCHES



### BLACK HIGH-LEVERAGE WRENCH BAR



- Anti-slip rubber grip.
- Recommended when high-torque is needed and striking is restricted, mainly in mining, oil and gas industry, and heavy- industry.

**BULK**

ITEM	INTERNAL DIAMETER	TOTAL LENGTH (A)	☐	AVAILABLE
24HL1B	1"	36"	1	✓

### BLACK HIGH-LEVERAGE WRENCH BARS



**BULK**

ITEM	INTERNAL DIAMETER	TOTAL LENGTH (A)	☐	AVAILABLE
26HL1B	1/2"	22"	1	On Request
26HL2B	3/4"	26"	1	✓
26HL3B	1"	36"	1	✓

### BLACK HIGH-LEVERAGE OFFSET WRENCH BARS



- Less effort when torque is applied.
- Assembly system quick to lever.

**BULK**

ITEM	INTERNAL DIAMETER	TOTAL LENGTH (A)	☐	AVAILABLE
27HL1B	1"	30"	1	On Request
27HL2B	1-3/16"	33-3/4"	1	On Request

## INDUSTRIAL WRENCHES

**HIGH-LEVERAGE WRENCHES**

**BLACK SAE HIGH-LEVERAGE BOX-END WRENCHES 12 POINT**

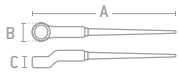

• Exceeds federal GGG-W-636E standard.

**BULK**

ITEM	OPENING DIMENSION	TOTAL LENGTH	BAR SIZE			OUTER DIAMETER	HEAD DEPTH	□	AVAILABLE
			1/2"	3/4"	1"				
2616HL	1"	12"	•			1-9/16"	11/16"	1	✓
2617HL	1-1/16"	15"	•			1-11/16"	13/16"	1	✓
2618HL	1-1/8"	15"	•			1-11/16"	13/16"	1	✓
2620HL	1-1/4"	17"	•			2"	13/16"	1	✓
2621HL	1-5/16"	17"	•			2"	13/16"	1	✓
2623HL	1-7/16"	21"	•			2-3/16"	1"	1	✓
2624HL	1-1/2"	21"	•			2-3/16"	1"	1	✓
2626HL	1-5/8"	22"	•			2-1/2"	1-1/8"	1	✓
2627HL	1-11/16"	22"	•			2-1/2"	1-1/8"	1	✓
2629HL	1-13/16"	24"	•			2-13/16"	1-1/4"	1	✓
2630HL	1-7/8"	24"	•			2-13/16"	1-1/4"	1	✓
2632HL	2"	24"	•			2-13/16"	1-1/4"	1	✓

**BLACK METRIC HIGH-LEVERAGE BOX-END WRENCHES 12 POINT**

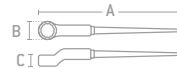

• Exceeds federal GGG-W-636E standard.

**BULK**

ITEM	OPENING DIMENSION	TOTAL LENGTH	BAR SIZE			OUTER DIAMETER	HEAD DEPTH	□	AVAILABLE
			1/2"	3/4"	1"				
2624MHL	24 mm	12"	•			1-9/16"	11/16"	1	✓
2625MHL	25 mm	12"	•			1-9/16"	11/16"	1	✓
2626MHL	26 mm	15"	•			1-11/16"	13/16"	1	✓
2627MHL	27 mm	15"	•			1-11/16"	13/16"	1	✓
2628MHL	28 mm	15"	•			1-11/16"	13/16"	1	✓
2632MHL	32 mm	17"	•			2"	13/16"	1	✓
2634MHL	34 mm	17"	•			2"	13/16"	1	✓
2636MHL	36 mm	21"	•			2-3/16"	1"	1	✓
2641MHL	41 mm	22"	•			2-1/2"	1-1/8"	1	✓
2646MHL	46 mm	24"	•			2-13/16"	1-1/4"	1	✓
2650MHL	50 mm	24"	•			2-13/16"	1-1/4"	1	On Request

**BLACK SAE HIGH-LEVERAGE BOX-END WRENCHES 12 POINT**

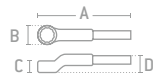
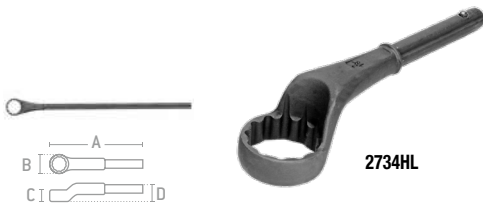

• High-leverage bar is sold separately (part no. 24HL1B).  
• Lever sold separately, there are fastened with bolt.  
• Bolt-on assembly system.

**BULK**

ITEM	OPENING SIZE	TOTAL LENGTH (A)	BAR		WIDE MOUTH (B)	KEY THICKNESS (C)	ELBOW-HEIGHT (D)	□	AVAILABLE
			27HL1B	27HL2B					
2734HL	2-1/8"	12-5/64"	•	-	3"	1-1/16"	2-51/64"	1	On Request
2735HL	2-3/16"	12-5/64"	•	-	3"	1-1/16"	2-51/64"	1	✓
2736HL	2-1/4"	12-5/64"	-	•	3"	1-1/16"	2-51/64"	1	On Request
2738HL	2-3/8"	13-23/32"	-	•	3-7/16"	1-7/32"	3-3/16"	1	✓
2740HL	2-1/2"	13-23/32"	-	•	3-7/16"	1-7/32"	3-3/16"	1	✓
2741HL	2-9/16"	14"	-	•	3-13/16"	1-17/64"	3-13/32"	1	✓
2742HL	2-5/8"	14"	-	•	3-13/16"	1-17/64"	3-13/32"	1	✓
2744HL	2-3/4"	14-1/2"	-	•	4-1/32"	1-11/32"	3-15/32"	1	✓
2746HL	2-7/8"	14-1/2"	-	•	4-1/32"	1-11/32"	3-15/32"	1	On Request
2747HL	2-15/16"	14-7/8"	-	•	4-19/64"	1-31/64"	3-9/16"	1	On Request
2748HL	3"	14-7/8"	-	•	4-19/64"	1-31/64"	3-9/16"	1	On Request
2750HL	3-1/8"	15-17/64"	-	•	4-7/8"	1-21/32"	3-11/16"	1	✓
2756HL	3-1/2"	15-17/64"	-	•	4-7/8"	1-21/32"	3-11/16"	1	On Request
2760HL	3-3/4"	16-9/64"	-	•	5-1/2"	1-13/16"	4-1/32"	1	✓
2762HL	3-7/8"	16-9/64"	-	•	5-1/2"	1-13/16"	4-1/32"	1	On Request

**BLACK METRIC HIGH-LEVERAGE BOX-END WRENCHES 12 POINT**

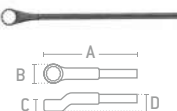

• High-leverage bar is sold separately (part no. 24HL1B).  
• Lever sold separately, there are fastened with bolt.  
• Bolt-on assembly system.

**BULK**

ITEM	OPENING SIZE	TOTAL LENGTH (A)	BAR		WIDE MOUTH (B)	KEY THICKNESS (C)	ELBOW-HEIGHT (D)	□	AVAILABLE
			27HL1B	27HL2B					
2755MHL	55mm	12-5/64"	•	-	3"	1-1/16"	2-51/64"	1	On Request
2760MHL	60mm	13-23/32"	-	•	3-7/16"	1-7/32"	3-3/16"	1	On Request
2765MHL	65mm	14"	-	•	3-13/16"	1-17/64"	3-13/32"	1	On Request
2770MHL	70mm	14-1/2"	-	•	4-1/32"	1-11/32"	3-15/32"	1	On Request
2775MHL	75mm	14-7/8"	-	•	4-19/64"	1-31/64"	3-9/16"	1	On Request
2780MHL	80mm	15-17/64"	-	•	4-7/8"	1-21/32"	3-11/16"	1	On Request
2785MHL	85mm	15-17/64"	-	•	4-7/8"	1-21/32"	3-11/16"	1	On Request

## HIGH-LEVERAGE WRENCHES

### BLACK SAE HIGH-LEVERAGE BOX-END WRENCHES 12 POINT



2470HL

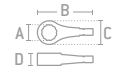

- High-leverage bar is sold separately (part no. 24HL1B).
- Compact design easy to carry.

**BULK**

ITEM	OPENING SIZE	TOTAL LENGTH (A)	OUTER DIAMETER (B)	HEAD DEPTH (C)	⊞	AVAILABLE
2468HL	2-1/8"	10-13/16"	3-1/2"	1-1/2"	1	On Request
2470HL	2-3/16"	10-13/16"	3-1/2"	1-1/2"	1	On Request
2472HL	2-1/4"	10-13/16"	3-1/2"	1-1/2"	1	On Request
2476HL	2-3/8"	11-1/8"	3-3/4"	1-5/8"	1	On Request
2480HL	2-1/2"	12-1/2"	4-1/2"	1-3/4"	1	On Request
2482HL	2-9/16"	12-1/2"	4-1/2"	1-3/4"	1	On Request
2488HL	2-3/4"	12-1/2"	4-1/2"	1-3/4"	1	On Request
2494HL	2-15/16"	12"	4-3/4"	1-7/8"	1	On Request
2496HL	3"	12"	4-3/4"	1-7/8"	1	On Request
2499HL	3-1/8"	12"	4-3/4"	1-7/8"	1	On Request

### BLACK METRIC HIGH-LEVERAGE BOX-END WRENCHES 12 POINT



2455MHL



- High-leverage bar is sold separately (part no. 24HL1B).
- Compact design easy to carry.

**BULK**

ITEM	OPENING SIZE	TOTAL LENGTH (A)	OUTER DIAMETER (B)	HEAD DEPTH (C)	⊞	AVAILABLE
2455MHL	55 mm	10-13/16"	3-1/2"	1-1/2"	1	On Request
2460MHL	60 mm	11-1/8"	3-3/4"	1-5/8"	1	On Request
2465MHL	65 mm	12-1/2"	4-1/2"	1-3/4"	1	On Request
2470MHL	70 mm	12-1/2"	4-1/2"	1-3/4"	1	On Request

### BLACK SAE HIGH-LEVERAGE OPEN-END FLAT WRENCHES



2580HL



- High-leverage bar is sold separately (part no. 24HL1B).
- Compact design easy to carry.

**BULK**

ITEM	OPENING SIZE	TOTAL LENGTH (A)	OUTER DIAMETER (B)	HEAD DEPTH (C)	⊞	AVAILABLE
2568HL	2-1/8"	12-5/16"	4-1/2"	1-3/16"	1	On Request
2570HL	2-3/16"	12-5/16"	4-1/2"	1-3/16"	1	On Request
2572HL	2-1/4"	12-5/16"	4-1/2"	1-3/16"	1	On Request
2576HL	2-3/8"	12-5/16"	4-1/2"	1-3/16"	1	On Request
2580HL	2-1/2"	13-1/3"	5-7/16"	1-7/16"	1	On Request
2582HL	2-9/16"	13-1/3"	5-7/16"	1-7/16"	1	On Request
2588HL	2-3/4"	13-1/3"	5-7/16"	1-7/16"	1	On Request
2594HL	2-15/16"	13-1/3"	5-7/16"	1-7/16"	1	On Request
2596HL	3"	13-1/3"	5-7/16"	1-7/16"	1	On Request
2599HL	3-1/8"	13-1/3"	5-7/16"	1-7/16"	1	On Request

### BLACK METRIC HIGH-LEVERAGE OPEN-END FLAT WRENCHES



2565MHL



- High-leverage bar is sold separately (part no. 24HL1B).
- Compact design easy to carry.

**BULK**

ITEM	OPENING SIZE	TOTAL LENGTH (A)	OUTER DIAMETER (B)	HEAD DEPTH (C)	⊞	AVAILABLE
2555MHL	55 mm	12-5/16"	4-1/2"	1-3/16"	1	✓
2560MHL	60 mm	12-5/16"	4-1/2"	1-3/16"	1	✓
2565MHL	65 mm	13-1/3"	5-7/16"	1-7/16"	1	On Request
2570MHL	70 mm	13-1/3"	5-7/16"	1-7/16"	1	On Request

**STRIKING WRENCHES**

**BLACK SAE FLAT STRIKING WRENCHES 12 POINT**



• Wide striking area provides greater confidence and safety when hammering

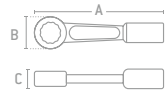

2729SW

- Made of chrome-molybdenum steel
- Exceeds FEDERAL GGG-W-636E standard
- Flat design.
- Zinc phosphate finish
- The flat design of these wrenches (in-line head and shank) makes them particularly suitable for applications where there are no obstacles blocking tool operation

**BULK**

ITEM	OPENING SIZE	TOTAL LENGTH (A)	OUTER DIAMETER (B)	HEAD DEPTH (C)	☐	AVAILABLE	ITEM	OPENING SIZE	TOTAL LENGTH (A)	OUTER DIAMETER (B)	HEAD DEPTH (C)	☐	AVAILABLE
2716SW	1"	9-1/2"	2-15/64"	55/64"	1	✓	2740SW	2-1/2"	14-51/64"	4-7/64"	1-31/64"	1	✓
2717SW	1-1/16"	9-1/2"	2-15/64"	55/64"	1	✓	2741SW	2-9/16"	14-51/64"	4-7/64"	1-31/64"	1	✓
2718SW	1-1/8"	9-1/2"	2-15/64"	55/64"	1	✓	2742SW	2-5/8"	14-51/64"	4-7/64"	1-31/64"	1	✓
2719SW	1-3/16"	9-1/2"	2-15/64"	55/64"	1	✓	2744SW	2-3/4"	16-25/64"	4-5/16"	1-5/16"	1	✓
2720SW	1-1/4"	9-1/2"	2-15/64"	55/64"	1	✓	2746SW	2-7/8"	16-25/64"	4-5/16"	1-5/16"	1	✓
2721SW	1-5/16"	9-1/2"	2-15/64"	55/64"	1	✓	2747SW	2-15/16"	16-25/64"	4-5/16"	1-5/16"	1	✓
2722SW	1-3/8"	9-1/2"	2-15/64"	55/64"	1	✓	2748SW	3"	16-25/64"	4-5/16"	1-5/16"	1	✓
2723SW	1-7/16"	11-21/64"	3"	63/64"	1	✓	2750SW	3-1/8"	18-13/32"	4-15/16"	1-7/16"	1	✓
2724SW	1-1/2"	11-21/64"	3"	63/64"	1	✓	2754SW	3-3/8"	18-13/32"	4-15/16"	1-7/16"	1	✓
2726SW	1-5/8"	11-21/64"	3"	63/64"	1	✓	2756SW	3-1/2"	18-13/32"	4-15/16"	1-7/16"	1	✓
2727SW	1-11/16"	11-21/64"	3"	63/64"	1	✓	2760SW	3-3/4"	15-3/8"	5-9/16"	1-9/16"	1	✓
2728SW	1-3/4"	11-21/64"	3"	63/64"	1	✓	2762SW	3-7/8"	15-3/8"	5-9/16"	1-9/16"	1	✓
2729SW	1-13/16"	11-21/64"	3"	63/64"	1	✓	2766SW	4-1/8"	16-9/16"	6-1/8"	1-3/4"	1	✓
2730SW	1-7/8"	11-21/64"	3"	63/64"	1	✓	2768SW	4-1/4"	17-11/16"	6-11/16"	1-7/8"	1	✓
2731SW	1-15/16"	11-21/64"	3-47/64"	1-31/64"	1	✓	2772SW	4-1/2"	17-11/16"	6-11/16"	1-7/8"	1	✓
2732SW	2"	13-31/64"	3-47/64"	1-31/64"	1	✓	2774SW	4-5/8"	17-11/16"	6-11/16"	1-7/8"	1	✓
2734SW	2-1/8"	13-31/64"	3-47/64"	1-31/64"	1	✓	2776SW	4-3/4"	18-11/16"	7-1/4"	2-1/8"	1	✓
2735SW	2-3/16"	13-31/64"	3-47/64"	1-31/64"	1	✓	2780SW	5"	18-11/16"	7-1/4"	2-1/8"	1	✓
2736SW	2-1/4"	13-31/64"	3-47/64"	1-31/64"	1	✓	2786SW	5-3/8"	20-11/16"	8"	2-5/16"	1	✓
2737SW	2-5/16"	13-31/64"	3-47/64"	1-31/64"	1	✓	2792SW	5-3/4"	22-13/16"	8-7/8"	2-1/2"	1	On Request
2738SW	2-3/8"	14-51/64"	4-7/64"	1-31/64"	1	✓	2796SW	6"	22-13/16"	8-7/8"	2-1/2"	1	✓

**BLACK METRIC FLAT STRIKING WRENCHES 12 POINT**



• Wide striking area provides greater confidence and safety when hammering

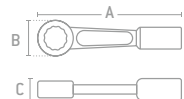

2730SWM

- Made of chrome-molybdenum steel
- Exceeds FEDERAL GGG-W-636E standard
- Flat design.
- Zinc phosphate finish
- The flat design of these wrenches (in-line head and shank) makes them particularly suitable for applications where there are no obstacles blocking tool operation.
- Ideal for rounded or damaged nuts, and recommended for heavy-duty applications due to increased contact surface with the nut.

**BULK**

ITEM	OPENING SIZE	TOTAL LENGTH (A)	OUTER DIAMETER (B)	HEAD DEPTH (C)	☐	AVAILABLE	ITEM	OPENING SIZE	TOTAL LENGTH (A)	OUTER DIAMETER (B)	HEAD DEPTH (C)	☐	AVAILABLE
2724SWM	24 mm	9-1/2"	2-15/64"	55/64"	1	✓	2770SWM	70 mm	16-3/8"	4-5/16"	1-3/8"	1	✓
2727SWM	27 mm	9-1/2"	2-15/64"	55/64"	1	✓	2775SWM	75 mm	16-3/8"	4-21/64"	1-19/64"	1	✓
2730SWM	30 mm	9-1/2"	2-15/64"	55/64"	1	✓	2780SWM	80 mm	18-3/8"	4-31/32"	1-1/2"	1	✓
2732SWM	32 mm	9-1/2"	2-15/64"	55/64"	1	✓	2785SWM	85 mm	18-3/8"	4-15/16"	1-9/16"	1	✓
2736SWM	36 mm	11-21/64"	3"	63/64"	1	✓	2790SWM	90 mm	15-1/4"	5-1/8"	1-3/8"	1	✓
2741SWM	41 mm	11-21/64"	3"	63/64"	1	✓	2795SWM	95 mm	15-3/8"	5-9/16"	1-3/8"	1	✓
2746SWM	46 mm	11-21/64"	3"	63/64"	1	✓	27100SWM	100 mm	16-1/2"	6-3/16"	1-3/4"	1	✓
2750SWM	50 mm	13-31/64"	3-47/64"	1-31/64"	1	✓	27105SWM	105 mm	16-1/2"	6-3/16"	1-3/4"	1	On Request
2755SWM	55 mm	13-31/64"	3-47/64"	1-31/64"	1	✓	27110SWM	110 mm	17-3/4"	5-1/2"	1-13/16"	1	✓
2760SWM	60 mm	14-13/16"	4-7/64"	1-31/64"	1	✓	27115SWM	115 mm	17-3/4"	6-1/2"	1-15/16"	1	✓
2765SWM	65 mm	14-13/16"	4-7/64"	1-31/64"	1	✓	27120SWM	120 mm	18"	7-1/8"	2-1/4"	1	✓

## STRIKING WRENCHES

### BLACK SAE FLAT STRIKING WRENCHES 6 POINT



• Wide striking area provides greater confidence and safety when hammering

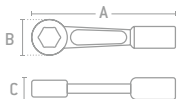

2729SWH

- Made of chrome-molybdenum steel
- Exceeds FEDERAL GGG-W-636E standard
- Flat design.
- Zinc phosphate finish
- The flat design of these wrenches (in-line head and shank) makes them particularly suitable for applications where there are no obstacles blocking tool operation.
- Ideal for rounded or damaged nuts, and recommended for heavy-duty applications due to increased contact surface with the nut.

**BULK**

ITEM	OPENING SIZE	TOTAL LENGTH (A)	OUTER DIAMETER (B)	HEAD DEPTH (C)	⊞	AVAILABLE
2712SWH	3/4"	7-1/2"	7-1/2"	11/16"	1	✓
2714SWH	7/8"	7-1/2"	7-1/2"	11/16"	1	✓
2716SWH	1"	9-1/2"	9-1/2"	55/64"	1	✓
2717SWH	1-1/16"	9-1/2"	9-1/2"	55/64"	1	✓
2718SWH	1-1/8"	9-1/2"	9-1/2"	55/64"	1	✓
2720SWH	1-1/4"	9-1/2"	9-1/2"	55/64"	1	✓
2722SWH	1-3/8"	9-1/2"	9-1/2"	55/64"	1	✓
2723SWH	1-7/16"	11-21/64"	11-21/64"	63/64"	1	✓
2724SWH	1-1/2"	11-21/64"	11-21/64"	63/64"	1	✓
2726SWH	1-5/8"	11-21/64"	11-21/64"	63/64"	1	✓
2728SWH	1-3/4"	11-21/64"	11-21/64"	63/64"	1	✓
2729SWH	1-13/16"	11-21/64"	11-21/64"	63/64"	1	✓

ITEM	OPENING SIZE	TOTAL LENGTH (A)	OUTER DIAMETER (B)	HEAD DEPTH (C)	⊞	AVAILABLE
2730SWH	1-7/8"	11-21/64"	11-21/64"	63/64"	1	✓
2732SWH	2"	13-31/64"	13-31/64"	31/64"	1	✓
2735SWH	2-3/16"	13-31/64"	13-31/64"	1-31/64"	1	✓
2736SWH	2-1/4"	13-31/64"	13-31/64"	1-31/64"	1	✓
2738SWH	2-3/8"	14-13/16"	14-13/16"	1-31/64"	1	✓
2740SWH	2-1/2"	14-13/16"	14-13/16"	1-31/64"	1	✓
2741SWH	2-9/16"	14-13/16"	14-13/16"	1-31/64"	1	✓
2744SWH	2-3/4"	16-3/8"	11-13/16"	1-3/16"	1	✓
2747SWH	2-15/16"	16-3/8"	14-13/16"	1-31/64"	1	✓
2750SWH	3-1/8"	18 3/8"	14"	1-1/2"	1	✓
2756SWH	3-1/2"	14-3/16"	14-13/16"	1-7/16"	1	✓

## 6-POINT THIN-WALL FLAT STRIKING WRENCHES



### SAE THIN WALL FLAT STRIKING WRENCHES 6 POINT



2829SWH

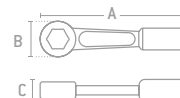

- Made of chrome-molybdenum steel
- Exceeds FEDERAL GGG-W-636E standard
- The flat design of these wrenches (in-line head and shank) makes them particularly suitable for applications where there are no obstacles blocking tool operation.
- Ideal for rounded or damaged nuts, and recommended for heavy-duty applications due to increased contact surface with the nut.

**BULK**

ITEM	OPENING SIZE	TOTAL LENGTH (A)	OUTER DIAMETER (B)	HEAD DEPTH (C)	⊞	AVAILABLE
2817SWH	1-1/16"	9"	1-11/16"	15/16"	1	✓
2820SWH	1-1/4"	10"	1-15/16"	15/16"	1	✓
2823SWH	1-7/16"	11-13/16"	2-1/4"	1-1/8"	1	✓
2826SWH	1-5/8"	11-15/16"	2-1/2"	1-1/8"	1	✓
2829SWH	1-13/16"	12"	2-11/16"	1-1/8"	1	On Request
2832SWH	2"	3-1/16"	2-15/16"	1-11/16"	1	✓
2835SWH	2-3/16"	13-29/64"	3-3/16"	1-11/16"	1	✓
2838SWH	2-3/8"	14-3/8"	3-7/16"	1-11/16"	1	✓
2841SWH	2-9/16"	14-3/8"	3-11/16"	1-11/16"	1	✓
2844SWH	2-3/4"	14-5/32"	3-15/16"	1-7/8"	1	✓

### HEX OPENING

Hexagonal opening that perfectly fits hexagonal nuts, providing greater contact area.

Thin wall allows you to work on flanges when bolts are located close to each other or are very close to the pipe.

Electrostatic paint prevents corrosion and allows you to easily identify the tool.

Greater impact surface than conventional striking wrenches.

I-beam body gives the wrench greater endurance and torque transfer

Hexagon size and nut diameter markings.

**STRIKING WRENCHES**

**BLACK SAE OFFSET STRIKING WRENCHES 12 POINT**



**URREA**



• Wide striking area provides greater confidence and safety when hammering.



2650SW

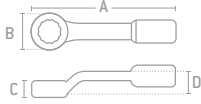

- Made of chrome-molybdenum steel
- Exceeds FEDERAL GGG-W-636E standard
- The offset design of these wrenches (head angled in relation to the shank) makes them particularly suitable for use in areas where an object or obstacle restricts tool movement.
- Their construction and structure allow heavy hammering to loosen the nut.

**BULK**

ITEM	OPENING SIZE	TOTAL LENGTH (A)	OUTER DIAMETER (B)	HEAD DEPTH (C)	OFFSET HEIGHT (D)	☐	AVAILABLE
2616SW	1"	8-1/2"	1-11/16"	5/8"	15/16"	1	✓
2617SW	1-1/16"	8-1/2"	1-11/16"	5/8"	15/16"	1	✓
2618SW	1-1/8"	8-1/2"	1-11/16"	5/8"	15/16"	1	✓
2619SW	1-3/16"	10-3/4"	1-7/8"	13/16"	1-3/16"	1	✓
2620SW	1-1/4"	10-3/4"	1-7/8"	13/16"	1-3/16"	1	✓
2621SW	1-5/16"	10-3/4"	1-7/8"	13/16"	1-3/16"	1	✓
2622SW	1-3/8"	12"	2-3/16"	1"	1-1/2"	1	✓
2623SW	1-7/16"	12"	2-3/16"	1"	1-1/2"	1	✓
2624SW	1-1/2"	12"	2-3/16"	1"	1-1/2"	1	✓
2625SW	1-9/16"	12-1/4"	2-13/32"	1-1/8"	1-1/2"	1	✓
2626SW	1-5/8"	12-1/4"	2-13/32"	1-1/8"	1-1/2"	1	✓
2627SW	1-11/16"	12-1/4"	2-13/32"	1-1/8"	1-1/2"	1	✓
2628SW	1-3/4"	13-7/16"	2-21/32"	1-3/16"	1-9/16"	1	✓
2629SW	1-13/16"	13-5/8"	2-27/32"	1-1/4"	1-21/32"	1	✓
2630SW	1-7/8"	13-5/8"	2-27/32"	1-1/4"	1-21/32"	1	✓
2631SW	1-15/16"	13-5/8"	2-27/32"	1-1/4"	1-21/32"	1	✓

ITEM	OPENING SIZE	TOTAL LENGTH (A)	OUTER DIAMETER (B)	HEAD DEPTH (C)	OFFSET HEIGHT (D)	☐	AVAILABLE
2632SW	2"	14-1/8"	2-27/32"	1-1/4"	1-21/32"	1	✓
2634SW	2-1/8"	14"	3-13/16"	1-3/8"	2-3/8"	1	✓
2635SW	2-3/16"	14"	3-13/16"	1-3/8"	2-3/8"	1	✓
2636SW	2-1/4"	14-1/8"	3-13/16"	1-3/8"	2-3/8"	1	✓
2637SW	2-5/16"	14-1/4"	3-7/8"	1-5/16"	2-1/4"	1	✓
2638SW	2-3/8"	14"	3-13/16"	1-5/16"	2-9/16"	1	✓
2639SW	2-11/16"	14-3/4"	4-1/16"	1-5/16"	2-9/16"	1	✓
2640SW	2-1/2"	14"	4-1/16"	1-5/16"	2-9/16"	1	✓
2641SW	2-9/16"	14-1/2"	4-1/16"	1-5/16"	2-9/16"	1	✓
2642SW	2-5/8"	14-1/4"	4-1/16"	1-11/16"	2-9/16"	1	✓
2643SW	2-11/16"	14-3/4"	4-13/16"	1-11/16"	2-15/16"	1	✓
2644SW	2-3/4"	16"	4-13/16"	1-11/16"	2-15/16"	1	✓
2646SW	2-7/8"	16"	4-13/16"	1-11/16"	2-15/16"	1	✓
2647SW	2-15/16"	15-9/16"	4 13/16"	1-5/8"	2-15/16"	1	✓
2648SW	3"	15-3/4"	4-7/8"	1-5/8"	3-1/4"	1	✓
2650SW	3-1/8"	15-7/8"	4-7/8"	2"	3-1/2"	1	✓

**BLACK METRIC OFFSET STRIKING WRENCHES 12 POINT**



**URREA**



• Wide striking area provides greater confidence and safety when hammering.



2680SWM

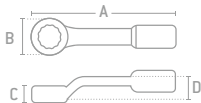

- Made of chrome-molybdenum steel
- Exceeds FEDERAL GGG-W-636E standard
- The offset design of these wrenches (head angled in relation to the shank) makes them particularly suitable for use in areas where an object or obstacle restricts tool movement.
- Their construction and structure allow heavy hammering to loosen the nut.

**BULK**

ITEM	OPENING SIZE	TOTAL LENGTH (A)	OUTER DIAMETER (B)	HEAD DEPTH (C)	OFFSET HEIGHT (D)	☐	AVAILABLE
2632SWM	32 mm	10-3/4"	1-7/8"	13/16"	1-3/16"	1	✓
2633SWM	33 mm	10-3/4"	1-7/8"	13/16"	1-3/16"	1	✓
2634SWM	34 mm	10-3/4"	1-7/8"	13/16"	1-3/16"	1	✓
2636SWM	36 mm	12"	2-3/16"	1"	1-1/2"	1	✓
2641SWM	41 mm	12-1/4"	2-13/32"	1-1/8"	1-1/2"	1	✓
2646SWM	46 mm	13-7/16"	2-21/32"	1-3/16"	1-9/16"	1	✓
2650SWM	50 mm	13-7/16"	2-27/32"	1-1/4"	1-21/32"	1	✓

ITEM	OPENING SIZE	TOTAL LENGTH (A)	OUTER DIAMETER (B)	HEAD DEPTH (C)	OFFSET HEIGHT (D)	☐	AVAILABLE
2655SWM	55 mm	14"	3-13/16"	1-5/16"	2-1/8"	1	✓
2660SWM	60 mm	14"	3-13/16"	1-5/16"	2-3/16"	1	✓
2665SWM	65 mm	14-1/2"	4-1/16"	1-5/16"	2-1/2"	1	✓
2670SWM	70 mm	15-7/8"	4-13/16"	1-9/16"	2-1/2"	1	✓
2675SWM	75 mm	15-3/16"	4-3/4"	1-9/16"	2-3/8"	1	✓
2680SWM	80 mm	15-7/8"	4-7/8"	1-3/8"	2-3/8"	1	✓

## STRUCTURAL WRENCHES

### URREA STRUCTURAL WRENCHES HEAVY INDUSTRY

Can be used to align flanges thanks to its conical end. This tool is indispensable in heavy industries such as petroleum, power generation, and gas processing

Robust box-end, used to tighten nuts or bolt heads with greater torque.

The end of the handle is conical shape, so it can be used as an alignment bar when centering holes in assembly operations.

Open end angled relative to the handle to facilitate engagement with nuts, used for final tightening of nuts or bolt heads.

# STRUCTURAL WRENCHES

ZINC PHOSPHATE FINISH

SUPER DRIVE

Forged conical end that can be used as an alignment bar.

### OPEN-END WRENCHES

These wrenches have a fixed opening, commonly known as an open end. The end of the handle has a conical shape, so it can be used as an alignment bar for centering holes during assembly operations. The handle is positioned above the open-end head, making it more comfortable and safer to maneuver.

### BOX-END WRENCHES

A typical application for these wrenches is connecting flanged components, where the flanges are solid plate connectors bolted together through holes arranged radially around the pipe. The handle features a curved radius that positions it on a higher plane relative to the box end, improving maneuverability and enhancing user safety.

MECHANICAL WRENCHES

### BLACK SAE STRUCTURAL BOX-END WRENCHES 12 POINT



STANDARD



ZINC PHOSPHATE FINISH

SUPER DRIVE

URREA

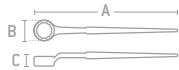

2623

- Made of chrome-molybdenum steel.
- Exceeds FEDERAL GGG-W-636E standard.
- Tapered bar handle.
- Zinc phosphate finish.
- Ideal for flange alignment and high-torque nut adjustment.

ITEM	OPENING DIMENSION	TOTAL LENGTH (A)	OUTSIDE DIAMETER (B)	HEAD THICKNESS (C)	⊞	AVAILABLE
2613	13/16"	12"	11/16"	1-1/16"	1	✓
2614	7/8"	12"	1-3/8"	1-1/16"	1	✓
2615	15/16"	12"	1-9/16"	1-3/16"	1	✓
2616	1"	12"	1-9/16"	1-3/16"	1	✓
2617	1-1/16"	15"	1-11/16"	7/8"	1	✓
2618	1-1/8"	15"	1-11/16"	7/8"	1	✓
2620	1-1/4"	17"	1-7/16"	1-5/16"	1	✓
2621	1-5/16"	17"	1-7/16"	1-1/16"	1	✓

BULK

ITEM	OPENING DIMENSION	TOTAL LENGTH (A)	OUTSIDE DIAMETER (B)	HEAD THICKNESS (C)	⊞	AVAILABLE
2623	1-7/16"	21"	1-1/2"	1-1/8"	1	✓
2624	1-1/2"	21"	1-1/2"	1-1/8"	1	✓
2626	1-5/8"	22"	2-1/2"	1-3/16"	1	✓
2627	1-11/16"	22"	2-1/2"	1-3/16"	1	✓
2629	1-13/16"	24"	1-13/16"	1-1/4"	1	✓
2630	1-7/8"	24"	2-3/4"	1-1/4"	1	✓
2632	2"	24"	3"	1-3/8"	1	✓

### BLACK SAE STRUCTURAL BOX-END WRENCHES 12 POINT



STANDARD



ZINC PHOSPHATE FINISH

URREA



C908

- Made of chrome-molybdenum steel.
- Exceeds FEDERAL GGG-W-636E standard.
- Tapered bar handle.
- Zinc phosphate finish.
- Ideal for flange alignment and high-torque nut adjustment.

ITEM	OPENING DIMENSION	TOTAL LENGTH (A)	OUTSIDE DIAMETER (B)	HEAD THICKNESS (C)	⊞	AVAILABLE
C903A	5/8"	11-3/4"	2-1/4"	7/16"	1	✓
C903	11/16"	11-3/4"	2-1/4"	7/16"	1	✓
C904A	3/4"	12"	1-7/8"	7/16"	1	✓
C905	7/8"	14-1/2"	1-7/8"	9/16"	1	✓
C905B	15/16"	14-1/4"	2-1/4"	1/2"	1	✓
C906B	1"	14-1/2"	2-3/16"	1/2"	1	✓
C907	1-1/16"	17"	1-7/8"	1/2"	1	✓
C907A	1-1/8"	17"	2-3/16"	5/8"	1	✓
C908	1-1/4"	19"	2 7/16"	5/8"	1	✓

BULK

ITEM	OPENING DIMENSION	TOTAL LENGTH (A)	OUTSIDE DIAMETER (B)	HEAD THICKNESS (C)	⊞	AVAILABLE
C908A	1-5/16"	19"	2-7/16"	11/16"	1	✓
C909	1-7/16"	21"	2-3/4"	3/4"	1	✓
C909A	1-1/2"	21"	2-3/4"	3/4"	1	✓
C910	1-5/8"	23"	3-1/8"	7/8"	1	✓
C910A	1-11/16"	23"	3-1/4"	7/8"	1	✓
C911	1-13/16"	25"	4-7/16"	1"	1	✓
C911A	1-7/8"	25"	4-7/16"	1"	1	✓
C912	2"	25"	4-7/16"	1"	1	✓





CLASS	TYPE	PAGE	BRAND	
			URREA	SURTEK
Torque multipliers	Torque multiplier	225	•	
	Dial electronic torque wrenches	225	•	
Torque wrenches	Click torque wrenches	226	•	•
	Dial torque wrenches	226	•	
	Preset torque wrenches	226	•	
Torque screwdrivers	Torque screwdrivers	228	•	
Torque wrenches	Beam torque wrenches	228		•

[usa.urrea.com](http://usa.urrea.com)

We are constantly improving our products, that is why the information, characteristics and availability of them can change without prior notice.

# TORQUE MULTIPLIERS AND TORQUE WRENCHES SELECTION GUIDE

To help you choose the best option that suits your needs as example below:

## TORQUE MULTIPLIER

1 REQUIRED TORQUE:  
2,000 FT-LB

Torque multiplier capacity should be **10% - 40%** greater than required torque.

2,000 x 1.4 = **2,800** ft-lb

2,000 x 1.1 = **2,200** ft-lb



2 REQUIRED CAPACITY:  
BETWEEN **2,200** AND **2,800** FT-LB



The correct model is **6222** with a maximum torque of **2,200** ft-lb and a relation **1:12**.

## TORQUE WRENCH

3 REQUIRED INPUT TORQUE (FOR THE MULTIPLIER):

Torque multiplier capacity should be **10% - 40%** greater than required torque.

$$\text{Input torque} = \frac{2,000 \text{ ft-lb (Required torque)}}{12 \text{ (Torque relation)}} = \mathbf{167 \text{ FT-LB}}$$

167 x 1.4 = **234** ft-lb

167 x 1.1 = **184** ft-lb



4 REQUIRED CAPACITY:  
Torque wrench required capacity must be between **184** and **234** ft-lb



The correct model is **6045FL** with a torque range of **50-450** ft-lb and input drive **3/4"**.

## QUICK REFERENCE TORQUE MULTIPLIER SELECTION GUIDE

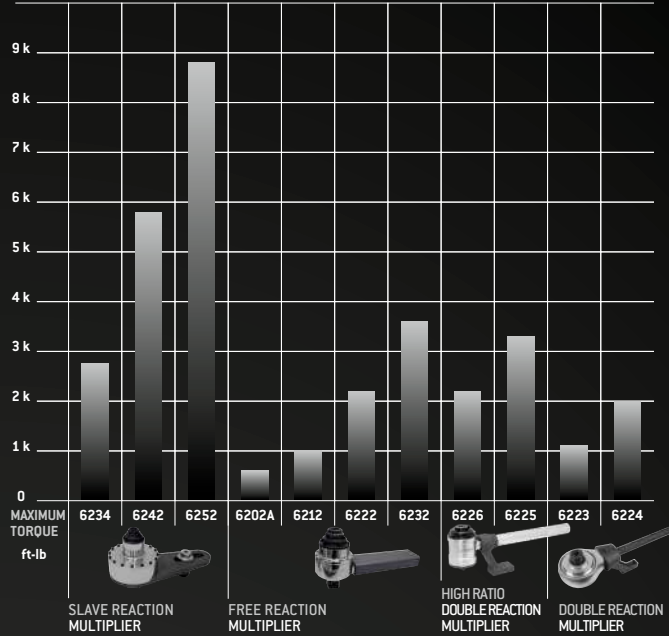

## QUICK REFERENCE TORQUE WRENCH SELECTION GUIDE

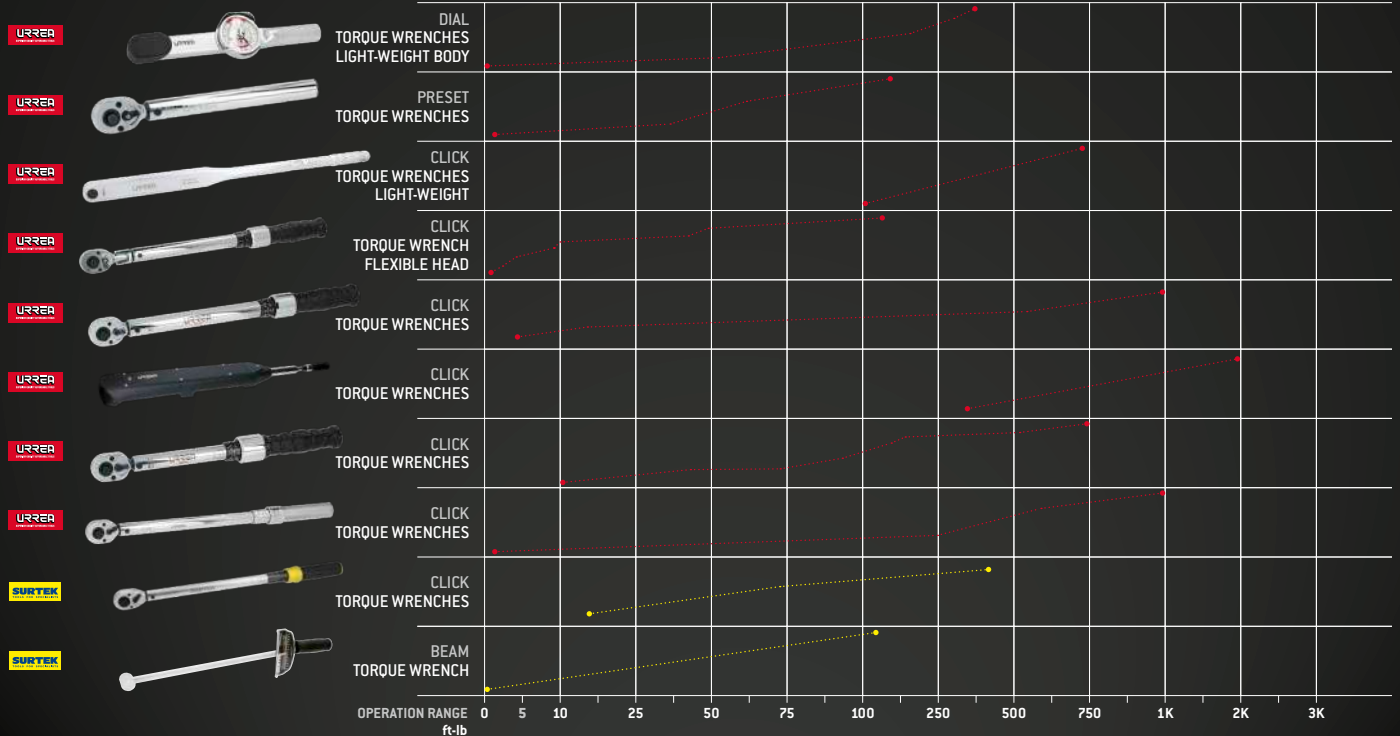

**TORQUE MULTIPLIERS**

**TORQUE MULTIPLIERS**



6232

Pipe reaction anchor

- Strong-Steel housing protects internal gears against impacts.
- Strong-handle for safer support.
- Fuse type system that avoids internal fractures.



6225

Dual reaction High relation

- Graduated scale for measuring angle of rotation.
- Double reaction (Lever and Type Z).



6224

Dual reaction

- Made of high quality carbon steel.
- Ideal for automotive and aerospace.
- Double reaction (Lever and Type Z).



• Ideal for use in building and maintenance machinery and in the automotive industry where requires big torque appliances and with reduced works areas.

ITEM	LENGTH	DRIVE		MAXIMUM TORQUE		TORQUE RATIO	WEIGHT	☑	AVAILABLE	
		H	M	INPUT	OUTPUT					
<b>Integrated reaction anchor</b>										
6234	10-5/8"	3/4"	1"	211 ft-lb	2,750 ft-lb	1:13	13.23 lb	1	✓	
6242	14-15/16"	3/4"	1-1/2"	118 ft-lb	5,800 ft-lb	1:49	37.48 lb	1	On Request	
6252	16-1/2"	3/4"	1-1/2"	169 ft-lb	8,800 ft-lb	1:52	49.60 lb	1	✓	
<b>Pipe reaction anchor</b>										
6202A	8-1/2"	1/2"	3/4"	168 ft-lb	590 ft-lb	1:3.5	4.4 lb	1	✓	
6212	2-7/16"	3/4"	3/4"	286 ft-lb	1,000 ft-lb	1:3.5	6.61 lb	1	✓	
6222	13"	3/4"	1"	183 ft-lb	2,200 ft-lb	1:12	13.22 lb	1	✓	
6232	15-3/4"	3/4"	1-1/2"	300 ft-lb	3,600 ft-lb	1:12	20.94 lb	1	On Request	
<b>Dual reaction high relation</b>										
6226	21-1/4"	1/2"	1"	142 ft-lb	2,200 ft-lb	1:15.5	17.2 lb	1	On Request	
6225	21-1/4"	1/2"	1"	127 ft-lb	3,300 ft-lb	1:26	19.6 lb	1	✓	
<b>Dual reaction</b>										
6223	15-1/3"	1/2"	3/4"	220 ft-lb	1,100 ft-lb	1:5	8.8 lb	1	✓	
6224	15-1/3"	3/4"	1"	440 ft-lb	2,000 ft-lb	1:5	9.2 lb	1	✓	

**TORQUE MULTIPLIERS SPARE PARTS**

**TORQUE MULTIPLIER SPARE PART FOR MODELS UP TO 2013**



6212RR

• Spare parts for torque multipliers models up to 2013.



**BULK**

ITEM	GEAR FOR MODEL	☑	AVAILABLE
6212RR	6212	1	✓
6222RR	6222	1	✓
6232RR	6232 - 6234	1	✓
6242RR	6242	1	✓

**TORQUE MULTIPLIER SPARE PART FOR MODELS BEFORE 2013**



6202AR

• Spare parts for torque multipliers models up to 2013.



**BULK**

ITEM	GEAR FOR MODEL	☑	AVAILABLE
6202AR	6202A	1	✓
6212R	6212	1	✓
6222R	6222	1	✓
6232R	6232	1	✓
6234R	6234	1	✓
6242R	6242	1	On Request
6252R	6252	1	✓
6262R	6262 - (6252 for models before 2013)	1	✓

**TORQUE MULTIPLIER SPARE PARTS**



6223T

• Transmission shaft spare part.



6223P

• Planetary assembly spare part.



**BULK**

ITEM	DESCRIPTION	☑	AVAILABLE
R6226T	For transmission shaft 6226	1	✓
6225T	For transmission shaft 6225	1	✓
R6226PE	Input for planetary assembly 6226	1	✓
R6226PS	Input for planetary assembly 6226	1	✓
6225PE	Input for planetary assembly 6225	1	On Request
6225PS	Input for planetary assembly 6225	1	On Request

ITEM	DESCRIPTION	☑	AVAILABLE
6223T	For transmission shaft 6223	1	✓
6224T	For transmission shaft 6224	1	✓
6223P	Input for planetary assembly 6223	1	On Request
6224P	Input for planetary assembly 6224	1	✓

**DIGITAL TORQUE WRENCHES**



AUDIBLE AND LED ALERT MODES.

- Blinking LED's and audible tone sounds when set the torque value is reached.
- LCD screen displays all information.
- Flexible head for more comfortable applications in limited spaces.
- Ratchet type system.
- 4 torque unit scales: ft-lb, in-lb, Nm, Kg-cm
- Quick release system



ITEM	TYPE	LENGTH	DRIVE	TORQUE RANGE			☑	AVAILABLE
				FT - LB	IN - LB	NM		
6310	Digital	15"	1/4"	2.0 - 20.0	24 - 240	2.7 - 27.12	1	On Request

## NEEDLE TORQUE WRENCHES

### DIAL TORQUE WRENCHES LIGHT WEIGHT BODY



6119

- For its lightness they are ideal for working at heights.
- Dial scale torque.
- chromium-molybdenum alloy body.



ITEM	LENGTH	DRIVE	TORQUE RANGE			⊞	AVAILABLE
			FT - LB	IN - LB	NM		
<b>IN-LB</b>							
6119	12-13/32"	3/8"	-	0-150	0-17.5	1	On Request
<b>FT-LB</b>							
6124	22"	1/2"	0-250	-	0-350	1	On Request
6126	47"	3/4"	0-600	-	0-800	1	On Request

## PRESET TORQUE WRENCHES

### PRESET TORQUE WRENCHES FT-LB



6000

- Pre-adjusted torque cannot be changed without the use of adjust-wrench. This prevents user from an accidental torque change
- Designed to be used in production and assembly lines where a specific torque is required in repetitive operations.  $\pm 3\%$  precision in right-direction, from 20-100% of its scale.
- Quick release system.
- Ratcheting system activated in two positions for turning to the left and right.
- Torque wrenches can be set to an specific torque range at customer's expense.



ITEM	LENGTH	DRIVE	TORQUE RANGE			⊞	AVAILABLE
			FT - LB	IN - LB	NM		
6000	6-1/2"	1/4"	1-5 ft-lb	12-60	1.3-6.7	1	✓
6001	7-1/4"	3/8"	3-9 ft-lb	36-108	4-12.2	1	✓
6002	11-1/2"	3/8"	10-50 ft-lb	120-600	13.5-67.8	1	On Request
6003	19-3/4"	1/2"	45-150 ft-lb	540-1,800	61-203.4	1	✓

## CLICK TORQUE WRENCHES

### CLICK TORQUE WRENCHES LIGHT WEIGHT FT-LB



Easy locking and adjustment.



Adjustable design.



61560

- Precision +/- 3%.
- Multi-lever mechanism brings length independence and accurate torque.



ITEM	LENGTH	DRIVE	TORQUE RANGE		WEIGHT	⊞	AVAILABLE
			FT - LB	NM			
61560	82 cm	3/4"	100-560	140-760	3 kg	1	✓
61730	82 cm	3/4"	140-740	200-1,000	3 kg	1	✓

### CLICK TORQUE WRENCHES FT-LB



6012A

- New handle with ergonomic anti-slip design.
- Click system: when defined torque is reached a tactil perceptible click is produced.



ITEM	LENGTH	DRIVE	TORQUE RANGE		⊞	AVAILABLE
			FT - LB	NM		
6006	15-1/2"	3/8"	5-75	98.2-102	1	✓
6012A	15-3/4"	3/8"	10-100	16.9-132.2	1	✓
6016	19"	1/2"	20-150	34-197	1	✓
60143	24-7/16"	1/2"	30-250	47-332	1	✓
6020	42-1/4"	3/4"	100-600	169-779	1	✓
6021	70"	1"	200-1,000	305-1,322	1	✓

### CLICK TORQUE WRENCHES WITH RUBBER GRIP FLEXIBLE HEAD FT-LB



6007

- Click system: when the defined torque is reached a tactilely perceptible click is produced.
- Flex-head for tight spaces where a big handle cant fit.
- Quick release system.
- Ratcheting system activated in two positions for turning to left and right.



ITEM	LENGTH	DRIVE	TORQUE RANGE		⊞	AVAILABLE
			FT - LB	NM		
6007	16-9/16"	3/8"	10-80	16.9-105.1	1	✓

### CLICK TORQUE WRENCHES FT-LB



538D

- Click system: when defined torque is reached a tactil perceptible click is produced.
- Quick release system



ITEM	LENGTH	DRIVE	TORQUE RANGE		⊞	AVAILABLE
			FT - LB	NM		
538D	16-17/32"	3/8"	15 - 88	20 - 120	1	On Request
512D	20-3/16"	1/2"	30 - 162	40 - 220	1	On Request
534D	26-13/16"	3/4"	74 - 442	100 - 600	1	On Request

CLICK TORQUE WRENCHES

CLICK TORQUE WRENCH FT-LB/NM



- Click system: when defined torque is reached a tactile perceptible click is produced.
- Dual scale ft-lb/Nm thunder torque wrench.
- Fixed head.



ITEM	LENGTH	DRIVE	TORQUE RANGE		☐	AVAILABLE
			FT - LB	NM		
6022	108-1/2"	1"	300-2,000	406.7-2,711.6	1	On Request

CLICK TORQUE WRENCHES IN-LB



6061A

- New handle with ergonomic anti-slip design.
- Click system: when defined torque is reached a tactile perceptible click is produced.



ITEM	LENGTH	DRIVE	TORQUE RANGE		☐	AVAILABLE
			IN - LB	NM		
6061A	9-15/16"	1/4"	10-50	1.1-5.6	1	✓
6062A	10-1/8"	1/4"	20-150	2.2-16.9	1	✓
6064A	11-1/4"	3/8"	30-250	3.3-28.2	1	✓
6066A	15-1/2"	3/8"	100-750	11.2-84.7	1	✓

CLICK TORQUE WRENCHES ONE SCALE



6010NM

- New scale in indelible low relief.
- One scale.
- Quick release system.
- Click system: when the defined torque is reached a tactilely perceptible click is produced.
- 3 position reversible ratchet:
- Left turn, right turn and fixed position of drive.
- Once the torque is defined, it does not require adjustment between tightening and tightening.
- Its design for continuous use provides the user with an excellent precision tool for specific torques.



FT-LB

ITEM	LENGTH	DRIVE	TORQUE RANGE	☐	AVAILABLE
6007FL	16-3/4"	3/8"	5-75 ft-lb	1	✓
6010FL	16-3/4"	3/8"	10-100 ft-lb	1	✓
6015FL	20-1/2"	1/2"	20-150 ft-lb	1	✓
6025FL	23-3/4"	1/2"	30-250 ft-lb	1	✓
6045FL	40-15/16"	3/4"	50-450 ft-lb	1	✓
6060FL	48-7/16"	3/4"	100-600 ft-lb	1	✓
601KFL	45-11/16"	1"	200-1,000 ft-lb	1	✓



IN-LB

ITEM	LENGTH	DRIVE	TORQUE RANGE	☐	AVAILABLE
6005IL	8-1/16"	1/4"	10-50 in-lb	1	✓
6015IL	8-1/16"	1/4"	20-150 in-lb	1	✓
6025IL	9-9/16"	3/8"	30-250 in-lb	1	✓
601KIL	16-3/4"	3/8"	200-1,000 in-lb	1	✓
603KIL	23-3/4"	1/2"	600-3,000 in-lb	1	✓



NM

ITEM	LENGTH	DRIVE	TORQUE RANGE	☐	AVAILABLE
6002NM	9-9/16"	1/4"	5-25 Nm	1	✓
6010NM	16-3/4"	3/8"	20-100 Nm	1	✓
6035NM	23-3/4"	1/2"	50-350 Nm	1	✓
6080NM	48-7/16"	3/4"	150-800 Nm	1	✓

## CLICK TORQUE WRENCHES

### BEAM TORQUE WRENCH FT-LB



NEW



- High visibility scale makes reading easier even in tough lighting conditions.
- It's a complete and easy-to-use professional tool for commercial or casual use.
- Certificate of calibration is not included.



ITEM	LENGTH	DRIVE	TORQUE RANGE	☞	AVAILABLE
107100	20-29/32"	1/2"	0-140 ft-lb	1	On Request



## TORQUE SCREWDRIVERS

### TORQUE TOOL COMBINED SET



7  
PIECES



Content		
6107A	1/4" torque screwdriver 5-40 in-lb	1
14008X	Slotted bit 5F-6R heavy duty	1
14012X	Slotted bit 6F-8R heavy duty	1
12004X	Phillips® bit #2 x 1-15/16 heavy duty	1
12008X	Phillips® bit #3 x 1-15/16 heavy duty	1
16032X	Torx® bit T30 x 1-15/16 heavy duty	1
CP19	9" Waterproof box	1

ITEM	PIECES	☞	AVAILABLE
JHT7	7	1	On Request

### MICROADJUSTABLE PLASTIC HANDLE TORQUE SCREWDRIVERS



6105A

- Lightweight.
- Easy to use.
- Scale is easy to read.
- Comfortable tri-lobular handle.
- Cam-based torque limiter.
- 1/4" interchangeable bit magnetic receptor.
- Automatically blocks counter-clockwise turning.
- Designed to eliminate over force applications, therefore reducing cost of damage, rejects and rework.



ITEM	LENGTH	TORQUE RANGE		DRIVE	☞	AVAILABLE
		IN-LB	IN-OZ			
<b>IN-OZ</b>						
6105A	3-7/8"	-	20-100	1/4"	1	✓
<b>IN-LB</b>						
6106A	4-1/2"	3-15	-	1/4"	1	✓
6107A	5-1/8"	5-40	-	1/4"	1	✓

### ADJUSTABLE PRESET TORQUE SCREWDRIVERS



6012

- These torque screwdrivers are adjustable to the torque range and adjustment specified by the customer.



ITEM	LENGTH	TORQUE RANGE	DRIVE	☞	AVAILABLE
6012	5-5/8"	1.5-15 in-lb	1/4"	1	✓
6013	6"	4-40 in-lb	1/4"	1	✓

### MICROADJUSTABLE PLASTIC HANDLE TORQUE SCREWDRIVERS



6108B

- High durability plastic handle.
- For assembly operations with desired torque adjustment.
- Adjustment ring.



ITEM	LENGTH	TORQUE RANGE	DRIVE	☞	AVAILABLE
6105B	7"	0.5-4 in-lb	1/4"	1	✓
6106B	7"	3-15 in-lb	1/4"	1	✓
6107B	7-7/8"	5-25 in-lb	1/4"	1	✓
6108B	7-7/8"	10-50 in-lb	1/4"	1	✓
6109B	7-7/8"	10-90 in-lb	1/4"	1	✓



CLASS	TYPE	PAGE	BRAND	
			URREA	SURTEK
Screwdrivers	Tri-material screwdrivers	230	*	
	Bi-material screwdrivers	232	*	*
	Cushion grip screwdrivers	236	*	
	Amber screwdriver	237	*	
	Red serie screwdriver	239	*	
	Blue screwdriver	240		*
	Yellow screwdriver	241		*
	Magnetizer - demagnetizer for screwdrivers tip	243	*	
	Offset cabinet screwdrivers	243	*	
Screwdrivers with interchangeable tips	Hand screwdriver with interchangeable bits set	243	*	*
Precision screwdrivers	Precision handle screwdrivers	246	*	*
Hex keys	T-handle hexagonal keys	248	*	
	L-handle hexagonal keys	253	*	*
	Combination folding hexagonal keys	259	*	*
Bits	Heavy-duty bit sets	262	*	
	Drive combined bits sets	266		*
	Power drive nut setters	267	*	*
	Power drive slotted bits	268	*	*
	Power drive phillips bits	269	*	*
	Power drive torx bits	270	*	*
	Power drive hexagonal bits	272		*
	Power drive square bits	272	*	
	Drive interchangeable slotted screwdriver bits	276	*	*
	Drive interchangeable torx screwdriver bits	277	*	
	Drive interchangeable hexagonales screwdriver bits	277	*	
	Drive interchangeable bristol screwdriver bits	278	*	*
	Drive hexagonal bit ratchets	278	*	
	Drive bit adapters	279	*	*

[usa.urrea.com](http://usa.urrea.com)

We are constantly improving our products, that is why the information, characteristics and availability of them can change without prior notice.

# SCREWDRIVER BITS TIPS TYPE.

## SLOTTED TIP FOR SLOTTED SCREWS

- Round bar. Greater resistance to torsion.
- Allows the use of a wrench to apply greater torque on the shank.

## PHILLIPS® TIP FOR USE ON PHILLIPS® HEAD SCREWS

- Round bar. Greater resistance to torsion.
- Allows the use of a wrench to apply greater torque on the shank.
- Phillips security pinhead.

## TORX® BIT FOR USE ON TORX® HEAD SCREWS

- Round bar. Higher torque and less tool wear.
- Round bar. Higher torque and less tool wear.
- Nut driver. Higher torque and less tool wear.

## CABINET® TIP FOR SCREWS LOCATED IN NARROW CAVITIES

- Round bar. Greater resistance to torsion.

## HEX® BIT FOR USE ON HEX HEAD SCREWS

- Inch hex bit and ball tip available.
- Metric hex bit and ball tip available.
- Inch hex nut drive
- Metric hex nut drive
- Safety hex tip.

## POZIDRIV BIT FOR USE POZIDRIV HEAD SCREWS

- Primarily used in electronics.

## BRISTOL® BIT FOR USE ON 12-POINT SOCKET SCREWS

- Primarily used in vehicle assemblies of European brands.

## SPANNER BIT FOR SPANNER SCREWS

- Security bit.

## TRIWING BIT FOR SCREWS TRIWING HEAD SCREWS

- It is used for consoles, mobile phones and cameras.

## GAMEBIT FOR USE ON GAMEBIT HEAD SCREWS

- It is used for consoles.

## PENTALOBULAR BIT FOR PENTALOBULAR SCREWS

- It is used in mobile phones and laptops.

## ROBERTSON® BIT FOR SQUARE DRIVE SCREWS

- Square bit

## TRIANGULAR BIT FOR SCREWS WITH TRIANGULAR HEAD

- It is used in electronics.

## SIM BIT FOR SPANNER SCREWS

- For mobile phones SIM card slot.

## SCHRADER VALVE TIP FOR SCHRADER TYPE VALVES

- It is used for tire inner tube valves.

## CLUTCH BIT FOR USE ON CLUTCH HEAD SCREWS

- 

## HEX BIT TO ADAPT TIPS

- For 1/4", 5/16", 3/8" and 1/2" bits.

## SQUARE BUT TO ADAPT SOCKETS

- For 1/4" and 3/8" sockets.

DRIVERS TOOLS

## TRIMATERIAL HANDLE

- Torsion-resistant red PP-type plastic.
- Gray TPE type plastic with soft rubber for better grip.
- Impact resistant black PP type plastic.



### HIGHER TORQUE

Hex section support point for greater torque with the help of a wrench.



Greater torque power, due to its tribolateral design.

### DESING DIAMOND

The handle integrates a diamond-patterned area for better hand grip and ventilation between the hand and the handle.

The bar is nickel-chrome plated for maximum protection.

# TRIMATERIAL SCREWDRIVERS.



Machined tip to exact tolerances.

Exceed ASME B107600, ISO 2380-1, ISO 8764-1. standards

### TRIMATERIAL HANDLE COMBINATION SCREWDRIVER SET



13  
PIECES



- Features a hexagonal shaft for applying greater torque with the help of a wrench.
- Exceeds ASME B107.600 standard.

Tip	Description	Pieces
	7/32", 1/4", *5/16", *3/8"	4
	1/4", 5/32", *7/32"	3
	PH00, PH0, PH1, PH2, *PH3, *PH2	6



ITEM	PIECES	AVAILABLE
JCDT13	13	1 ✓

### TRIMATERIAL HANDLE SCREWDRIVER SET WITH ACCESSORIES



23  
PIECES



- Exceeds ASME B107.600 standard.

Tip	Description	Pieces
	1/4" x 1-1/2", 5/16" x 6", 5/16" x 8", 3/16" x 4"	4
	PH2 x 1-1/2", PH1 x 3", PH1 x 4", PH2 x 6", PH3 x 8"	5
	T40 x 6", T20 x 4", T30 x 6", T25 x 4"	4
	T5 x 2", T6 x 2", PH00 x 2", PH000 x 2"	4
	PH2-1/4", PH1-3/16"	2
Accessories	4 mini hooks and point: Lezma type, curved hook, full hook, 90° hook.	4



ITEM	PIECES	AVAILABLE
JDT25	23	1 On Request



TRIMATERIAL HANDLE SCREWDRIVERS

TRIMATERIAL HANDLE SCREWDRIVER SET WITH ACCESSORIES



12  
PIECES



•Exceeds ASME B107.600 standard.

Tip	Description	Pieces
Slotted	1/4" x 1-1/2", 1/4" x 4", 3/16" x 4", 5/16" x 6".	4
Phillips®	PH2 x 1-1/2", PH2 x 4", PH3 x 6", PH1 x 3".	4
Precision	PH00 x 1-1/2", PH0 x 1-1/2".	2
Type Z	PH2-1/4".	1
Accessories	Demagnetizer	1



ITEM	PIECES	AVAILABILITY
JDT12	12	On Request

TRIMATERIAL HANDLE SCREWDRIVER SET WITH ACCESSORIES



5  
PIECES



•Exceeds ASME B107.600 standard.

Tip	Description	Pieces
Slotted	1/8" x 3", 5/16" x 6".	2
Phillips®	PH2 x 6", PH1 x 4".	2
Type Z	PH2-1/4".	1



ITEM	PIECES	AVAILABILITY
JDT5	5	On Request

TRIMATERIAL HANDLE SCREWDRIVER SET WITH ACCESSORIES



8  
PIECES



•Exceeds ASME B107.600 standard.

Tip	Description	Pieces
Slotted	1/4" x 1-1/2", 1/4" x 4", 3/16" x 4", 5/16" x 6".	4
Phillips®	PH2 x 1-1/2", PH2 x 4", PH3 x 6", PH1 x 3".	4



ITEM	PIECES	AVAILABILITY
JDT8	8	On Request

TRIMATERIAL HANDLE 1/4" HEXAGONAL BIT HOLDER FLEXIBLE BAR SCREWDRIVER

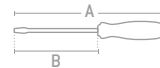

- Made of chrome vanadium steel.
- 1/4" drive size.
- Facilitates work in hard-to-reach areas, allowing easy entry and exit from the repair zone.

ITEM	BAR	TOTAL LENGTH (A)	EXPOSED LENGTH (B)	AVAILABILITY
9300TF	Round	10-13/32"	6"	On Request



URREA  
SUPERIOR QUALITY AFFORDABLE TOOLS

usa.urrea.com

## BIMATERIAL HANDLE SCREWDRIVERS

### STRIKING BIMATERIAL HANDLE SCREWDRIVERS

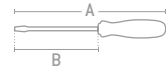

- New laser engraving for easy identification of code and size.



- Impact area integrated with the screwdriver shaft, allowing maximum performance during impact applications.



- Exclusive hole with metal-backed base for leverage application and increased torque.



- Steel insert with heat treatment.

- Made of chrome vanadium steel.
- Black oxide tip to prevent chromium peeling.
- Square shaft allows use of a wrench for higher torque application and improves bending resistance.
- Exceeds ASME B107.600, ISO 2380-1, and ISO 8764-1 standards.



**9116G**  
Slotted tip, square shank



**9184G**  
Phillips® tip, square shank



DRIVERS TOOLS

ITEM	SCREWDRIVER SETS			
	9100GB	9101GC	9100GC	9100GA
PIECES	7	7	7	6
PACKING				
AVAILABLE	1	5	1	1

ITEM	TIP TYPE	TIP SIZE	TOTAL LENGTH (A)	EXPOSED LENGTH (B)	AVAILABLE
9104G	Slotted	1/4"	8-1/2"	4"	1
9116G	Slotted	1/4"	10-1/2"	6"	1
9106G	Slotted	5/16"	11"	6"	1
9143G	Slotted	5/16"	15"	10"	1
9108G	Slotted	3/8"	13"	8"	1
9112G	Slotted	3/8"	17"	12"	1
9182G	Phillips®	PH1	7-1/2"	3"	1
9184G	Phillips®	PH2	8-1/2"	4"	1
9187G	Phillips®	PH2	10-1/2"	6"	1
9186G	Phillips®	PH3	11"	6"	1
9190G	Phillips®	PH3	15"	10"	1
9188G	Phillips®	PH4	13"	8"	1
9191G	Phillips®	PH4	17"	12"	1



**URREA**  
SUPERIOR QUALITY AFFORDABLE TOOLS

usa.urrea.com

BIMATERIAL HANDLE SCREWDRIVERS

BIMATERIAL HANDLE SCREWDRIVERS



URREA



IMPROVED PRODUCT



- Made of chrome vanadium steel.
- Red PP plastic resistant to torsion and impact + black soft TPE rubber plastic for improved grip.
- Hole for leverage application to increase torque.
- Exceeds ASME B107.110 and DIN 3125 standards.

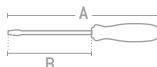

SCREWDRIVER SETS

ITEM	8600E	8600F	8600D	8600B	8600A	83W
PIECES	19	10	8	6	6	6
PACKING						
AVAILABLE	✓	✓	✓	✓	✓	✓

ITEM	TIP TYPE	TIP SIZE	TOTAL LENGTH (A)	EXPOSED LENGTH (B)	AVAILABLE
8602	Slotted	3/16"	8"	4"	✓
8604	Slotted	1/4"	8-7/16"	4"	✓
8616	Slotted	1/4"	10-7/16"	6"	✓
8606	Slotted	5/16"	10-13/16"	6"	✓
8643	Slotted	5/16"	14-13/16"	10"	✓
8608	Slotted	3/8"	12-13/16"	8"	✓
8652	Slotted	1/4"	4"	1-1/2"	✓
8804	Slotted	1/4"	8-7/16"	4"	✓
8816	Slotted	1/4"	10-7/16"	6"	✓
8806	Slotted	5/16"	10-13/16"	6"	✓
8843	Slotted	5/16"	14-13/16"	10"	✓
8808	Slotted	3/8"	12-13/16"	8"	✓
8810	Slotted	3/8"	14-13/16"	10"	✓
8812	Slotted	3/8"	16-7/8"	12"	✓
8624	Cabinet	1/8"	7-5/16"	4"	✓
8626	Cabinet	1/8"	9-1/8"	6"	✓
8631	Cabinet	3/16"	6-15/16"	3"	✓
8632	Cabinet	3/16"	8"	4"	✓
8634	Cabinet	3/16"	9-15/16"	6"	✓
8635	Cabinet	3/16"	11-15/16"	8"	✓
8636	Cabinet	1/4"	14-7/16"	10"	✓
8680	Phillips®	PH0	5-13/16"	2-1/2"	✓
8682	Phillips®	PH1	6-15/16"	3"	✓
8683	Phillips®	PH1	11-15/16"	8"	✓
8684	Phillips®	PH2	8-7/16"	4"	✓
8687	Phillips®	PH2	10-7/16"	6"	✓
8685	Phillips®	PH2	12-7/16"	8"	✓
8686	Phillips®	PH3	10-13/16"	6"	✓
8688	Phillips®	PH4	12-13/16"	8"	✓
8671	Phillips®	PH2	3-7/8"	1-3/8"	✓
8310W	Torx®	T10	8"	4"	✓
8315W	Torx®	T15	8"	4"	✓
8320W	Torx®	T20	8"	4"	✓
8325W	Torx®	T25	8"	4"	✓
8327W	Torx®	T27	8"	4"	✓
8330W	Torx®	T30	8"	4"	✓

## BIMATERIAL HANDLE SCREWDRIVERS

### BIMATERIAL HANDLE NUT DRIVERS

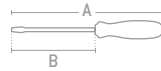
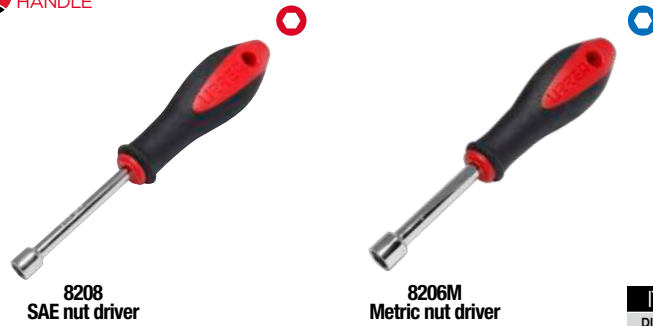

- Made of chrome vanadium steel.
- Red PP plastic resistant to torsion and impact + black TPE soft rubber plastic for improved grip.
- Nut driver tip and shaft forged as a single piece for greater torque resistance.
- Hole for leverage application to increase torque.
- Exceeds ASME B107.110 and DIN 3125 standards.

		NUT DRIVER SETS	
ITEM		8200	8200M
PIECES		6	9
PACKING			
AVAILABLE		1	1

ITEM	TYPE TIP	TIP SIZE	TOTAL LENGTH (A)	EXPOSED LENGTH (B)	AVAILABLE
8206	SAE nut driver	3/16"	7"	3"	✓
8208	SAE nut driver	1/4"	7"	3"	✓
8210	SAE nut driver	5/16"	7"	3"	✓
8212	SAE nut driver	3/8"	7"	3"	✓
8214	SAE nut driver	7/16"	7-3/8"	3"	✓
8216	SAE nut driver	1/2"	7-3/8"	3"	✓
8205M	Metric nut drivers	5 mm	7"	3"	✓
8206M	Metric nut drivers	6 mm	7"	3"	✓
8207M	Metric nut drivers	7 mm	7"	3"	✓
8208M	Metric nut drivers	8 mm	7"	3"	✓
8209M	Metric nut drivers	9 mm	7"	3"	✓
8210M	Metric nut drivers	10 mm	7-3/8"	3"	✓
8211M	Metric nut drivers	11 mm	7-3/8"	3"	✓
8212M	Metric nut drivers	12 mm	7-3/8"	3"	✓
8213M	Metric nut drivers	13 mm	7-3/8"	3"	✓

### BIMATERIAL HANDLE SCREWDRIVER COMBINATION SET



- Complies with ASME B107.600 standard.

Tip	Description	Pieces
Slotted	SL5/16"x6"; SL1/4"x4"; SL3/16"x3"; SL1/4"x1-1/2"	4
Precision	SL1/8"x2"; SL3/32"x2"	2
Phillips®	PH2x4"; PH1x3"; PH2x1-1/2"	3
Precision	PH0x2"; PH0x2"	2
Torx®	T5x2"; T6x2"; T7x2"; T8x2"; T9x2"; T10x2"	6
1" Bits		
Slotted	5/32"; 3/16"; 1/4"; 9/32"	4
Phillips®	PH1, PH2, PH2, PH3, PH3	5
Pozidriv	PZ1, PZ2, PZ2, PZ3, PZ3	5
Torx®	T15, T20, T25, T30	4
Accessories	Screwdriver	1

ITEM	PIECES	AVAILABLE
JDB36	36	On Request

### BIMATERIAL HANDLE SCREWDRIVER COMBINATION SET



- Complies with ASME B107.600 standard.

Tip	Description	Pieces
Slotted	SL1/4"x4"; SL3/16"x3"; SL1/4x1-1/2"	3
Precision	SL3/32"x2"; SL1/8"x2"	2
Phillips®	PH2x4"; PH1x3"; PH2x1-1/2"	3
Precision	PH0x2"; PH0x2"	2
Torx®	T8x2"; T9x2"; T10x2"	3

ITEM	PIECES	AVAILABLE
JDB13	13	On Request



- Complies with ASME B107.600 standard.

Tip	Description	Pieces
Plano	SL1/4"x4"; SL3/16"x3"; SL1/4x1-1/2"	3
Phillips®	PH2x4"; PH1x3"; PH2x1-1/2"	3
Accessories	Demagnetizer	1

ITEM	PIECES	AVAILABLE
JDB7	7	On Request

BIMATERIAL HANDLE SCREWDRIVERS

BIMATERIAL HANDLE SCREWDRIVERS

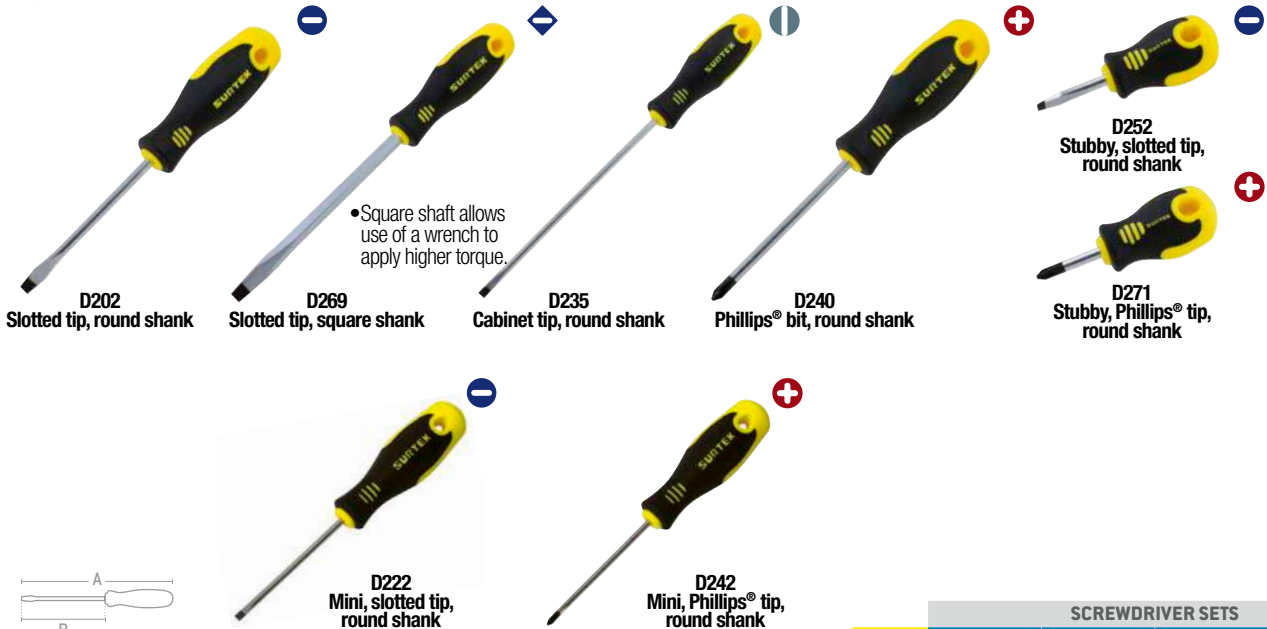

• Square shaft allows use of a wrench to apply higher torque.

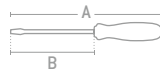

• New laser engraving for easy identification of code and size.

- Made of chrome vanadium steel.
- Black oxide tip to prevent chromium peeling.
- Hole for leverage application to increase torque.
- Complies with ASME B107.600, ISO 2380-1, and ISO 8764-1 standards.

SCREWDRIVER SETS				
ITEM	D20AC	D200A	D200B	D200C
PIECES	10	10	6	5
PACKING				
AVAIL	3	1	1	1

ITEM	TYPE TIP	TIP SIZE	TOTAL LENGTH (A)	EXPOSED LENGTH (B)	AVAIL	D20AC	D200A	D200B	D200C
D202	Slotted	3/16"	8"	4"	3	✓			
D204	Slotted	1/4"	8-1/4"	4"	3	✓			
D216	Slotted	1/4"	10-1/4"	6"	3	✓			
D206	Slotted	5/16"	10-3/4"	6"	3	✓			
D205	Slotted	5/16"	12-3/4"	8"	3	✓			
D220	Slotted	5/16"	14-3/4"	10"	3	✓			
D208	Slotted	3/8"	12-3/4"	8"	3	✓			
D232	Cabinet	1/8"	5"	4"	3	✓			
D224	Cabinet	3/16"	5-1/8"	4"	3	✓			
D234	Cabinet	3/16"	7-1/8"	6"	3	✓			
D235	Cabinet	3/16"	9-1/8"	8"	3	✓			
D230	Cabinet	1/4"	11-5/16"	10"	3	✓			
D264	Slotted	1/4"	8-1/4"	4"	3	✓			
D269	Slotted	1/4"	10-1/4"	6"	3	✓			
D266	Slotted	5/16"	10-3/4"	6"	3	On Request			
D240	Phillips®	PH0	7"	4"	3	✓			
D241	Phillips®	PH0	8"	6"	3	✓			
D243	Phillips®	PH1	7"	3"	3	✓			
D247	Phillips®	PH1	8"	4"	3	✓			
D249	Phillips®	PH1	10"	6"	3	✓			
D244	Phillips®	PH1	12"	8"	3	On Request			
D245	Phillips®	PH2	8-1/4"	4"	3	✓			
D251	Phillips®	PH2	10-1/4"	6"	3	✓			
D248	Phillips®	PH2	12-1/4"	8"	3	✓			
D246	Phillips®	PH3	10-3/4"	6"	3	✓			
D254	Phillips®	PH4	12-3/4"	8"	3	On Request			
D252	Slotted	1/4"	4"	1-1/2"	3	✓			
D271	Phillips®	PH2	5-1/2"	1-3/8"	3	✓			
D222	Slotted	1/8"	3-3/4"	2-1/2"	3	✓			
D242	Phillips®	PH0	5-1/2"	2-1/2"	3	On Request			

## CUSHION GRIP HANDLE SCREWDRIVERS

### CUSHION GRIP HANDLE SCREWDRIVERS



URREA



NEW

DRIVERS TOOLS

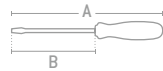
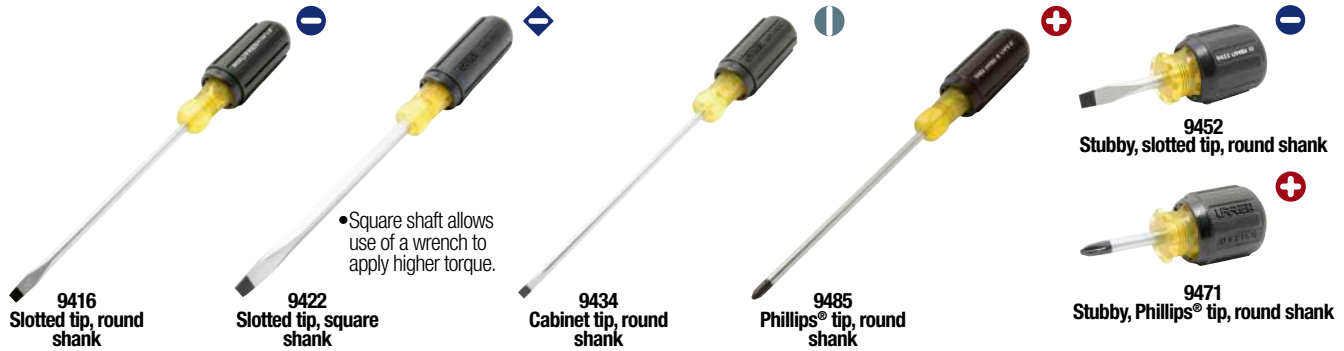

- Made of chrome vanadium steel.
- Cushion grip handle for increased comfort, providing a better grip and enabling higher torque application.
- Black oxide tip to prevent chromium peeling.
- Complies with ASME B107.600, ISO 2380-1, and ISO 8764-1 standards.

SCREWDRIVER SET			
ITEM	9401D	9400D	9400A
PIECES	8	8	7
PACKING			
AVAILABLE	1	1	1

ITEM	TYPE TIP	TIP SIZE	TOTAL LENGTH (A)	EXPOSED LENGTH(B)	AVAILABLE	9401D	9400D	9400A
9402	Slotted	3/16"	7-3/4"	4"	1	•	•	
9404	Slotted	1/4"	8-1/4"	4"	1	•	•	
9416	Slotted	1/4"	10-1/4"	6"	1			
9406	Slotted	5/16"	11"	6"	1	•	•	•
9408	Slotted	3/8"	13-3/8"	8"	1	•	•	
9410	Slotted	3/8"	15-3/8"	10"	1			
9412	Slotted	3/8"	17-3/8"	12"	1			
9421	Slotted	1/4"	8-1/4"	4"	1			•
9422	Slotted	5/16"	11"	6"	1			
9423	Slotted	3/8"	13-3/8"	8"	1			
9424	Slotted	3/8"	17-3/8"	12"	1			
9425	Cabinet	1/8"	7-3/4"	4"	1			
9431	Cabinet	3/16"	6-3/4"	3"	1			•
9432	Cabinet	3/16"	7-3/4"	4"	1			•
9434	Cabinet	3/16"	9-3/4"	6"	1			•
9435	Cabinet	3/16"	11-3/4"	8"	1			
9436	Cabinet	3/16"	13-3/4"	10"	1			
9452	Cabinet	PH1	6-3/4"	3"	1	•	•	•
9482	Phillips®	PH1	11-3/4"	8"	1			
9483	Phillips®	PH2	8-1/2"	4-1/4"	1	•	•	•
9484	Phillips®	PH2	10-1/4"	6"	1			
9485	Phillips®	PH2	12-1/4"	8"	1			
9481	Phillips®	PH2	14-1/4"	10"	1			
9489	Phillips®	PH2	16-1/4"	12"	1			
9488	Phillips®	PH3	11"	6"	1	•	•	
9486	Phillips®	PH4	13-3/8"	8"	1			
9487	Phillips®	1/4"	3-3/8"	1-1/2"	1	•	•	
9471	Phillips®	PH2	3-1/4"	1-3/8"	1			

AMBER HANDLE SCREWDRIVERS

AMBER HANDLE SCREWDRIVER



URREA



VIDEO

NEW

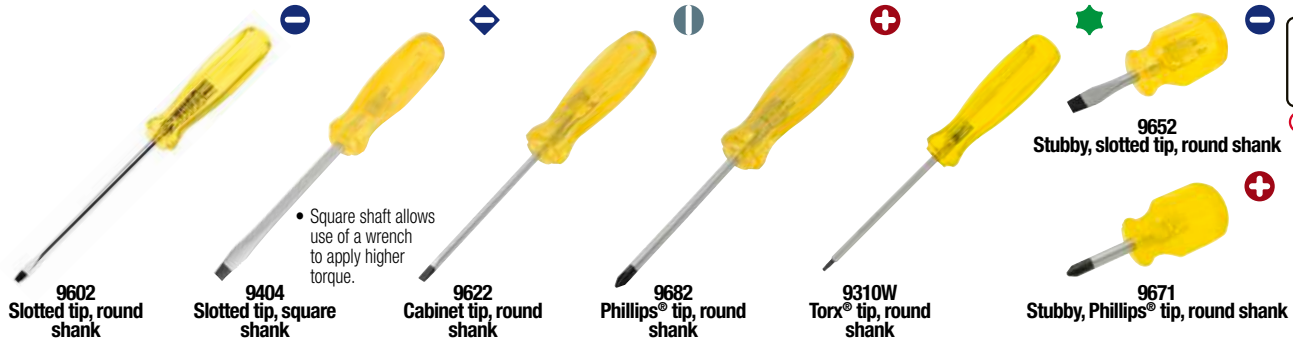

• Square shaft allows use of a wrench to apply higher torque.

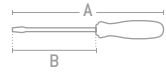

- Made of chrome vanadium steel.
- High-strength transparent plastic handle.
- Black oxide tip to prevent chromium peeling.
- Exceeds ASME B107.600, ISO 2380-1, and ISO 8764-1 standards.



SCREWDRIVER SET

ITEM	9600E	9601F	JBUD02	9601D	9600D	9800A	9601B	9600B	9600A	9600G	JBUD01	9600C	93W
PIECES	19	10	10	8	8	6	6	6	6	6	5	4	6
PACKING													
AVAILABLE	✓	✓	✓	✓	✓	✓	✓	✓	✓	✓	✓	✓	✓

ITEM	TYPE TIP	TIP SIZE	TOTAL LENGTH (A)	EXPOSED LENGTH (B)	AVAILABLE	9600E	9601F	JBUD02	9601D	9600D	9800A	9601B	9600B	9600A	9600G	JBUD01	9600C	93W	
9602	Slotted	3/16"	7-3/8"	4"	6	✓													
9604	Slotted	1/4"	8"	4"	6	✓													
9616	Slotted	1/4"	10"	6"	6	✓													
9606	Slotted	5/16"	10-3/8"	6"	6	✓													
9643	Slotted	5/16"	14-3/8"	10"	6	✓													
9608	Slotted	3/8"	13"	8"	6	✓													
9803	Slotted	1/4"	7"	3"	6	✓													
9804	Slotted	1/4"	8"	4"	6	✓													
9816	Slotted	1/4"	10"	6"	6	✓													
9842	Slotted	1/4"	13"	9"	6	✓													
9805	Slotted	5/16"	9-3/8"	5"	6	✓													
9806	Slotted	5/16"	10-3/8"	6"	6	✓													
9843	Slotted	5/16"	14-3/8"	10"	6	✓													
9808	Slotted	3/8"	13"	8"	6	✓													
9810	Slotted	3/8"	15"	10"	6	✓													
9812	Slotted	3/8"	17"	12"	6	✓													
9622	Cabinet	1/8"	5-1/4"	2-1/2"	6	✓													
9623	Cabinet	1/8"	5-3/4"	3"	6	✓													
9624	Cabinet	1/8"	6-3/4"	4"	6	✓													
9625	Cabinet	1/8"	7-3/4"	5"	6	✓													
9626	Cabinet	1/8"	8-3/4"	6"	6	✓													
9627	Cabinet	1/8"	10-3/4"	8"	6	✓													
9631	Cabinet	3/16"	6-3/8"	3"	6	✓													
9632	Cabinet	3/16"	7-3/8"	4"	6	✓													
9633	Cabinet	3/16"	8-3/8"	5"	6	✓													
9634	Cabinet	3/16"	9-3/8"	6"	6	✓													
9635	Cabinet	3/16"	11-3/8"	8"	6	✓													
9636	Cabinet	1/4"	14"	10"	6	✓													
9642	Cabinet	1/4"	16"	12"	6	✓													
9680	Phillips®	PH 0	5-1/4"	2-1/2"	6	✓													
9689	Phillips®	PH 0	10-3/4"	8"	6	✓													
9682	Phillips®	PH 1	6-3/8"	3"	6	✓													
9683	Phillips®	PH 1	11-3/8"	8"	6	✓													
9684	Phillips®	PH 2	8-1/4"	4"	6	✓													
9687	Phillips®	PH 2	9-15/16"	6"	6	✓													
9685	Phillips®	PH 2	12"	8"	6	✓													
9686	Phillips®	PH 3	10-3/8"	6"	6	✓													
9688	Phillips®	PH 4	13"	8"	6	✓													
9310W	Torx	T10	8"	4"	6	✓													
9315W	Torx	T15	8"	4"	6	✓													
9320W	Torx	T20	8"	4"	6	✓													
9325W	Torx	T25	8"	4"	6	✓													
9327W	Torx	T27	8"	4"	6	✓													
9330W	Torx	T30	8"	4"	6	✓													
9652	Slotted	1/4"	3-17/32"	1-1/2"	6	✓													
9671	Phillips®	PH 2	3-13/32"	1-3/8"	6	✓													

## AMBER HANDLE SCREWDRIVERS

### AMBER HANDLE NUT DRIVERS

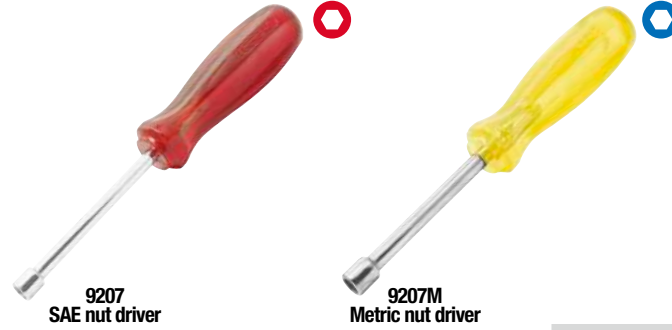

DRIVERS TOOLS

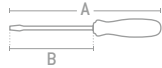

- Made of chrome vanadium steel.
- High-strength transparent plastic handle.
- Shaft and nut driver tip forged as a single piece for greater torque resistance.
- Exceeds ASME B107.110 and DIN 3125 standards.

ITEM	NUT DRIVER SETS			
	9201B	9200B	9231M	9230M
PIECES	10	6	11	7
PACKING				
AVAILABLE	1	1	1	1

ITEM	COLOR	TYPE TIP	TIP SIZE	TOTAL LENGTH	EXPOSED LENGTH	IN STOCK	AVAILABLE	9201B	9200B	9231M	9230M
9206	Black	SAE nut driver	3/16"	7"	3"	6	✓	•	•		
9207	Brown	SAE nut driver	7/32"	7"	3"	6	✓	•			
9208	Red	SAE nut driver	1/4"	7"	3"	6	✓	•	•		
9209	Orange	SAE nut driver	9/32"	7"	3"	6	✓	•			
9210	Amber	SAE nut driver	5/16"	7"	3"	6	✓	•	•		
9211	Green	SAE nut driver	11/32"	7"	3"	6	✓	•			
9212	Blue	SAE nut driver	3/8"	7"	3"	6	✓	•	•		
9214	Brown	SAE nut driver	7/16"	7-3/8"	3"	6	✓	•	•		
9216	Red	SAE nut driver	1/2"	7-3/8"	3"	6	✓	•	•		
9218	Amber	SAE nut driver	9/16"	7-3/8"	3"	6	✓	•			
9204M	Amber	Metric nut driver	4 mm	7"	3"	6	✓			•	
9205M	Amber	Metric nut driver	5 mm	7"	3"	6	✓			•	•
9255M	Amber	Metric nut driver	5.5 mm	7"	3"	6	✓			•	
9206M	Amber	Metric nut driver	6 mm	7"	3"	6	✓			•	•
9207M	Amber	Metric nut driver	7 mm	7"	3"	6	✓			•	•
9208M	Amber	Metric nut driver	8 mm	7"	3"	6	✓			•	•
9209M	Amber	Metric nut driver	9 mm	7"	3"	6	✓			•	•
9210M	Amber	Metric nut driver	10 mm	7-3/8"	3"	6	✓			•	•
9211M	Amber	Metric nut driver	11 mm	7-3/8"	3"	6	✓			•	•
9212M	Amber	Metric nut driver	12 mm	7-3/8"	3"	6	✓			•	
9213M	Amber	Metric nut driver	13 mm	7-3/8"	3"	6	✓			•	



**R-SERIES HANDLE SCREWDRIVERS**

**R-SERIES HANDLE SCREWDRIVERS**

**URREA**  
Hand Tools Division

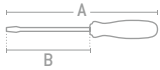

- Handle made of high-strength PP plastic
- Microalloyed steel shaft for maximum durability and strength.
- Black tip prevents chrome peeling.
- Exceeds ASME B107.600, ISO 2380-1, and ISO 8764-1 standards.



**SCREWDRIVER SET**

ITEM	9600ER	JBU03	9600DR	9800AR	9600BR	9600AR
PIECES	15	10	8	6	6	6
PACKING						
AVAILABLE	1	6	6	6	6	1

ITEM	TYPE TIP	TIP SIZE	TOTAL LENGTH (A)	EXPOSED LENGTH (B)	AVAILABLE
9602R	Slotted	3/16"	7-9/16"	4"	1
9604R	Slotted	1/4"	7-15/16"	4"	1
9616R	Slotted	1/4"	9-15/16"	6"	1
9606R	Slotted	5/16"	10-5/16"	6"	1
9643R	Slotted	5/16"	14-5/16"	10"	1
9608R	Slotted	3/8"	12-5/16"	8"	1
9804R	Slotted	1/4"	7-15/16"	4"	1
9816R	Slotted	1/4"	9-15/16"	6"	1
9806R	Slotted	5/16"	10-5/16"	6"	1
9808R	Slotted	3/8"	12-5/16"	8"	1
9812R	Slotted	3/8"	16-5/16"	12"	1
9622R	Cabinet	1/8"	5-5/8"	2-1/2"	1
9624R	Cabinet	1/8"	7-1/8"	4"	1
9632R	Cabinet	3/16"	7-3/8"	4"	1
9634R	Cabinet	3/16"	9-9/16"	6"	1
9635R	Cabinet	3/16"	11-3/8"	8"	1
9680R	Phillips®	PH 0	5-5/8"	2-1/2"	1
9682R	Phillips®	PH 1	6-9/16"	3"	1
9683R	Phillips®	PH 1	11-9/16"	8"	1
9684R	Phillips®	PH 2	8-3/16"	4"	1
9685R	Phillips®	PH 2	11-15/16"	8"	1
9686R	Phillips®	PH 3	10-5/16"	6"	1
9688R	Phillips®	PH 4	13"	8"	1
9652R	Slotted	1/4"	3-17/32"	1-1/2"	1
9671R	Phillips®	PH 2	3-13/32"	1-3/8"	1

## BLUE HANDLE SCREWDRIVERS

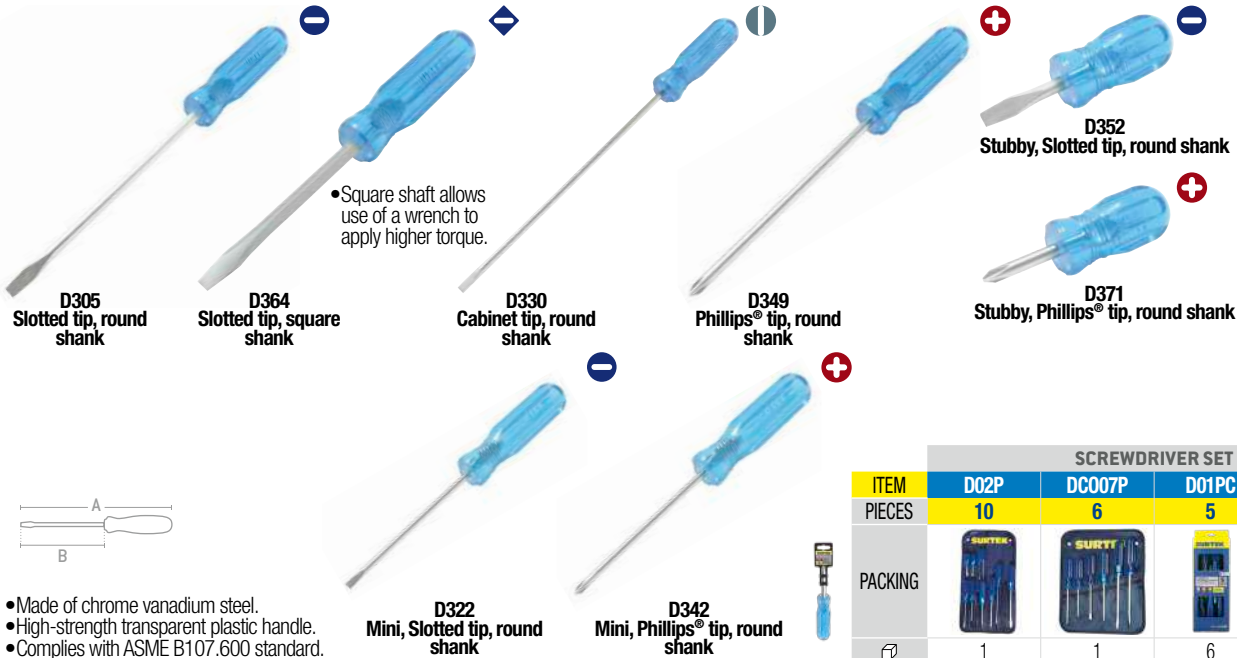

- Made of chrome vanadium steel.
- High-strength transparent plastic handle.
- Complies with ASME B107.600 standard.

ITEM	TYPE TIP	TIP SIZE	TOTAL LENGTH (A)	EXPOSED LENGTH (B)	AVAILABLE	SCREWDRIVER SET			
						D02P	DC007P	D01PC	D01P
D302	Plana	3/16"	7-11/16"	4"	6 ✓	✓	✓		
D304	Plana	1/4"	8"	4"	6 ✓	•		•	•
D316	Plana	1/4"	10"	6"	6 ✓				
D306	Plana	5/16"	10-5/16"	6"	6 ✓		•		
D305	Plana	5/16"	12-3/8"	8"	6 ✓				
D320	Plana	5/16"	14-3/8"	10"	6 ✓				
D308	Plana	3/8"	12-3/8"	8"	6 ✓				
D309	Plana	3/8"	16-5/16"	12"	6 ✓				
D364	Plana	1/4"	8"	4"	6 ✓				
D369	Plana	1/4"	10"	6"	6 ✓		•		
D366	Plana	5/16"	10-5/16"	6"	6 ✓	•			
D363	Plana	5/16"	14-5/16"	10"	6 ✓				
D368	Plana	3/8"	12-5/16"	8"	6 ✓				
D365	Plana	3/8"	14-5/16"	10"	6 ✓				
D367	Plana	3/8"	16-5/16"	12"	6 ✓				
D321	Cabinet	1/8"	5-3/8"	3"	6 ✓				
D332	Cabinet	1/8"	6-3/8"	4"	6 ✓			•	•
D325	Cabinet	1/8"	8-3/8"	6"	6 ✓				
D327	Cabinet	1/8"	10-3/8"	8"	6 ✓				
D324	Cabinet	3/16"	7-11/16"	4"	6 ✓		•	•	•
D334	Cabinet	3/16"	9-11/16"	6"	6 ✓	•			
D335	Cabinet	3/16"	11-5/8"	8"	6 ✓				
D330	Cabinet	1/4"	14"	10"	6 ✓				
D336	Cabinet	1/4"	16"	12"	6 ✓				
D340	Phillips®	PH0	6-3/8"	4"	6 ✓				
D341	Phillips®	PH0	8-3/8"	6"	6 ✓				
D381	Phillips®	PH0	10-3/8"	8"	6 ✓				
D343	Phillips®	PH1	6-11/16"	3"	6 ✓	•	•	•	•
D347	Phillips®	PH1	7-11/16"	4"	6 ✓				
D349	Phillips®	PH1	9-11/16"	6"	6 ✓				
D344	Phillips®	PH1	11-11/16"	8"	6 ✓				
D350	Phillips®	PH1	13-11/16"	10"	6 ✓				
D345	Phillips®	PH2	8-1/4"	4"	6 ✓	•	•	•	•
D351	Phillips®	PH2	10"	6"	6 ✓				
D348	Phillips®	PH2	12"	8"	6 ✓				
D353	Phillips®	PH2	16"	12"	6 ✓				
D346	Phillips®	PH3	10-5/16"	6"	6 ✓				
D354	Phillips®	PH4	12-5/16"	8"	6 ✓				
D352	Plana	1/4"	3-1/4"	1-1/2"	6 ✓	•			
D371	Phillips®	PH2	3-1/8"	1-3/8"	6 ✓	•			
D322	Plana	1/8"	4-7/8"	2-1/2"	6 ✓	•			
D342	Phillips®	PH0	4-7/8"	2-1/2"	6 ✓	•			

**BLUE HANDLE SCREWDRIVERS**



**BLUE-SERIES SCREWDRIVERS**

- New modern and more comfortable design, allowing easier screws tightening and loosening.
- Chrome vanadium tempered steel bar that prevents premature deformation of its tip.
- Great resistance to corrosion due to its bar with a double layer of chrome-nickel.
- High resistance acetate handle.
- Exceed ASME B107.600.

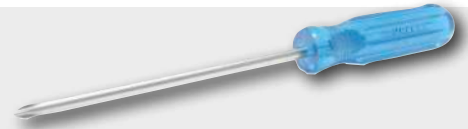

**SAE BLUE HANDLE NUT DRIVERS**



INCHES



**SURTEK**  
TOOL FOR PROGRESS



IMPROVED PRODUCT

NEW



D3510

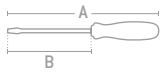

- Made of chrome vanadium steel.
- High-strength transparent plastic handle.
- Shaft and nut driver tip forged as a single piece for greater torque resistance.
- Complies with ASME B107.600 standard.

		SCREWDRIVER SET	
ITEM		D3500S	
PIECES		6	
PACKING			
		1	
AVAILABLE		✓	

ITEM	TIP TYPE	TIP SIZE	TOTAL LENGTH (A)	EXPOSED LENGTH (B)	6	AVAILABLE
D3506	SAE nut driver	3/16"	7"	3"	6	✓
D3508	SAE nut driver	1/4"	7"	3"	6	✓
D3510	SAE nut driver	5/16"	7-3/8"	3"	6	✓
D3512	SAE nut driver	3/8"	7-3/8"	3"	6	✓
D3514	SAE nut driver	7/16"	7-3/8"	3"	6	✓
D3516	SAE nut driver	1/2"	7-3/8"	3"	6	✓

**YELLOW HANDLE SCREWDRIVERS**

**YELLOW HANDLE STRIKING SCREWDRIVERS**



**SURTEK**  
TOOL FOR PROGRESS



NEW

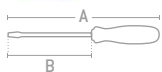

D416G  
Slotted tip, square shank



D445G  
Phillips® tip, square shank

- Made of chrome vanadium steel.
- Square shaft allows use of a wrench to apply higher torque.
- Complies with ASME B107.600 standard.

		SCREWDRIVER SET	
ITEM		D400G	
PIECES		8	
PACKING			
		1	
AVAILABLE		✓	

ITEM	TYPE TIP	TIP SIZE	TOTAL LENGTH (A)	EXPOSED LENGTH (B)	6	AVAILABLE
D403G	Slotted	3/16"	3"	3"	6	✓
D404G	Slotted	1/4"	4"	4"	6	✓
D416G	Slotted	1/4"	6"	6"	6	✓
D405G	Slotted	5/16"	8"	8"	6	✓
D443G	Phillips®	No. 1	3"	3"	6	✓
D445G	Phillips®	No. 2	4"	4"	6	✓
D451G	Phillips®	No. 2	6"	6"	6	✓
D454G	Phillips®	No. 3	8"	8"	6	On Request

## YELLOW HANDLE SCREWDRIVERS

### YELLOW HANDLE SCREWDRIVERS



NEW



VIDEO

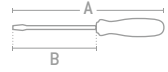
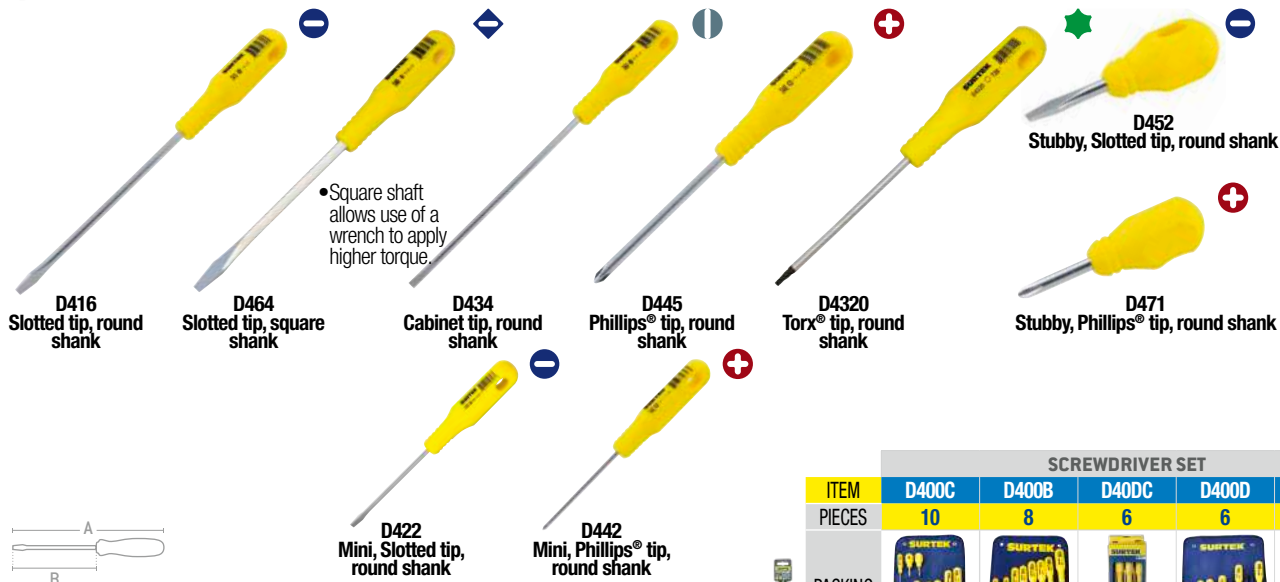

- Made of chrome vanadium steel.
- High-strength polypropylene (PP) handle.
- Complies with ASME B107.600 standard.

SCREWDRIVER SET					
ITEM	D400C	D400B	D400C	D400D	D400A
PIECES	10	8	6	6	5
PACKING					
AVAILABLE	1	1	6	1	1

ITEM	TYPE TIP	TIP SIZE	TOTAL LENGTH (A)	EXPOSED LENGTH (B)	AVAILABLE
D402	Slotted	3/16"	7-7/8"	6"	6
D404	Slotted	1/4"	8-1/4"	4"	6
D416	Slotted	1/4"	10-7/16"	6"	6
D406	Slotted	5/16"	10-11/16"	6"	6
D420	Slotted	5/16"	12-3/8"	8"	6
D408	Slotted	3/8"	14-3/4"	10"	6
D409	Slotted	3/8"	12-3/4"	8"	6
D464	Slotted	1/4"	16-3/4"	12"	6
D469	Slotted	1/4"	12-3/4"	8"	6
D466	Slotted	5/16"	10-5/16"	6"	6
D468	Slotted	3/8"	10-11/16"	6"	6
D465	Slotted	3/8"	12-3/4"	8"	6
D467	Slotted	3/8"	14-3/4"	10"	6
D421	Cabinet	1/8"	16-11/16"	12"	6
D432	Cabinet	1/8"	10"	6"	6
D425	Cabinet	1/8"	7-1/8"	4"	6
D424	Cabinet	3/16"	9-1/8"	6"	6
D434	Cabinet	3/16"	7-7/8"	4"	6
D440	Phillips®	PH0	10"	6"	6
D441	Phillips®	PH0	7-3/32"	4"	6
D443	Phillips®	PH1	9-1/8"	6"	6
D447	Phillips®	PH1	7"	3"	6
D449	Phillips®	PH1	7-7/8"	4"	6
D445	Phillips®	PH2	10"	6"	6
D451	Phillips®	PH2	8-1/4"	4"	6
D448	Phillips®	PH2	10-5/16"	6"	6
D446	Phillips®	PH3	12-5/16"	8"	6
D4310	Torx®	T10	10-3/4"	6"	6
D4315	Torx®	T15	8-1/4"	4"	6
D4320	Torx®	T20	8-1/4"	4"	6
D4325	Torx®	T25	8-1/4"	4"	6
D4327	Torx®	T27	8-1/4"	4"	6
D4330	Torx®	T30	8-1/4"	4"	6
D452	Slotted	1/4"	8-1/4"	4"	6
D471	Phillips®	PH2	3-11/16"	1-1/2"	6
D422	Slotted	1/8"	3-9/16"	1-3/8"	6
D442	Phillips®	PH0	5-5/8"	2-1/2"	6

DRIVERS TOOLS

**YELLOW HANDLE SCREWDRIVERS**

**SAE YELLOW HANDLE NUT DRIVERS**



INCHES



NEW

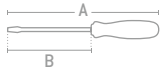

D4512

- Made of chrome vanadium steel.
- High-strength polypropylene (PP) handle.
- Shaft and nut driver tip forged as a single piece for greater torque resistance.
- Complies with ASME B107.600 standard.

ITEM	TIP TYPE	TIP SIZE	TOTAL LENGTH (A)	EXPOSED LENGTH (B)	⊞	AVAILABLE
D4508	SAE nut driver	1/4"	7"	3"	6	✓
D4510	SAE nut driver	5/16"	7"	3"	6	✓
D4512	SAE nut driver	3/8"	7"	3"	6	✓
D4514	SAE nut driver	7/16"	7-5/16"	3"	6	✓
D4516	SAE nut driver	1/2"	7-5/16"	3"	6	✓

**OFFSET CABINET SCREWDRIVERS**

**OFFSET CABINET SCREWDRIVERS**

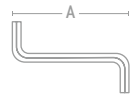

36 1/4

34 1/4

- Made of chrome vanadium steel.
- Phosphated finish that provides greater corrosion resistance.
- Design allows applying greater force to the screw thanks to its lever arm

ITEM	TIP TYPE	TIP SIZE	TOTAL LENGTH (A)	SCREW SIZE	⊞	AVAILABLE
35 1/4	Cabinet	1/4"	3"	10, 12	6	✓
36 1/4	Cabinet	1/4"	4"	10, 12	6	✓
36 5/16	Cabinet	5/16"	5"	12, 14, 16	6	✓
36 3/8	Cabinet	3/8"	6"	16, 18, 20	6	✓
34 1/4	Phillips®	PH 1-2	4-3/4"	1 - 2	6	✓
34 3/8	Phillips®	PH 3-4	6"	3 - 4	6	✓

**MAGNETIZER - DEMAGNETIZER**

**MAGNETIZER - DEMAGNETIZER FOR SCREWDRIVERS TIP**



- Ideal for screwdrivers or small steel parts.

ITEM	DIMENSIONS	⊞	AVAILABLE
9888	2-3/6" x 1-15/16" x 1-1/8"	1	✓

**HAND IMPACT SCREWDRIVER WITH INTERCHANGEABLE BITS**

**HAND IMPACT SCREWDRIVER WITH INTERCHANGEABLE BITS SET**



8  
PIECES



Tip	Description	Pieces
⊕ Phillips®	SL 6 x 3"	1
⊖ Cabinet	SL 8 x 3"	1
⊕ Phillips®	PH2, PH3 X 1-1/2"	2
⊖ Cabinet	SL6, SL8 X 1-1/2"	2
Accessories	Socket and hex square drive 5/16" x 1/2"	1
	Impact screwdriver	1

- Rotation mechanism activated by impact.
- Ideal for loosening stubborn screws, especially those surrounded by rust or adhesive/epoxy.
- 5/16" hexagonal tips.
- Solid steel body with heat treatment to prevent deformation.

ITEM	PIECES	⊞	AVAILABLE
70999A	8	1	✓

**HAND IMPACT SCREWDRIVER WITH INTERCHANGEABLE BITS SET**



8  
PIECES



D10

6  
PIECES



PFD10

Tip	Description	Pieces
⊖ Slotted	Slotted tips 1/4"	2
⊕ Phillips®	Phillips® tips PH2 y PH3	2
⊖ Slotted	Tip 5/16"	1
⊕ Phillips®	Phillips® tip de PH3	1
Accessories	1/2" Impact screwdriver	1
	Tips adapter	1

- Rotation mechanism activated by impact.
- 5/16" hexagonal tips.

ITEM	PIECES	⊞	AVAILABLE
D10	8	1	On Request

Replacement



ITEM	NO. TIPS	⊞	AVAILABLE
PFD10	6	1	On Request

## BIMATERIAL HANDLE INTERCHANGEABLE BIT RATCHETING SCREWDRIVERS

### BIMATERIAL HANDLE INTERCHANGEABLE BIT RATCHETING SCREWDRIVER



**MAGNETIC BIT HOLDER** **RATCHET SYSTEM**

**15 IN ONE**



- 3-position reversible ratchet system.
- Bits made of S2 steel.
- Shaft hole functions as a 1/4" hex nut driver.
- Exceeds ASME B107.600 standard.

Tip	Description	Length	Pieces
Slotted	4, 6	2"	2
Phillips®	PH0, PH1, PH2, PH3	2"	4
Hex	1/8", 5/32"	2"	2
Torx®	T10, T15, T20, T25, T27, T30	2"	6
Nut driver	1/4"		1

ITEM	DESCRIPTION	AVAILABLE
9315MM	Ratcheting 15 in 1	1 ✓

### BIMATERIAL HANDLE INTERCHANGEABLE BIT RATCHETING SCREWDRIVER



**MAGNETIC BIT HOLDER** **RATCHET SYSTEM**

**8 IN ONE**



- Bits made of S2 steel.
- Bit storage system in the handle.
- Exceeds ASME B107.600 standard.

Tip	Description	Length	Pieces
Slotted	1/4", 3/16"	1"	2
Phillips®	PH0, PH1, PH2	1"	3
Torx®	T15, T20	1"	2
Nut driver	1/4"		1

ITEM	DESCRIPTION	AVAILABLE
9308M	Ratcheting 8 in 1	1 ✓

### BIMATERIAL HANDLE FLEXIBLE INTERCHANGEABLE BIT RATCHETING SCREWDRIVER



**MAGNETIC BIT HOLDER** **RATCHET SYSTEM**

**7 IN ONE**



- Bits made of S2 steel.
- Bit storage system in the handle.
- Flexible handle to enhance torque transmission.
- Exceeds ASME B107.600 standard.

Tip	Description	Length	Pieces
Slotted	1/4", 3/16"	1"	2
Phillips®	PH1, PH2	1"	2
Torx®	T15, T20	1"	2
Nut driver	1/4"		1

ITEM	DESCRIPTION	AVAILABLE
9307F	Ratcheting 7 in 1, flexible	1 ✓

### BIMATERIAL HANDLE INTERCHANGEABLE LONG BITS RATCHETING SCREWDRIVER



**MAGNETIC BIT HOLDER** **RATCHET SYSTEM**

**7 IN ONE**



- Bits made of S2 steel.
- Bit storage system in the handle.
- Long bits for accessing tight spaces.
- Exceeds ASME B107.600 standard.

Tip	Description	Length	Pieces
Slotted	1/4", 3/16"	3.5"	2
Phillips®	PH1, PH2	3.5"	2
Torx®	T15, T20	3.5"	2
Nut driver	1/4"		1

ITEM	DESCRIPTION	AVAILABLE
9308L	7 in 1 ratcheting, long bits	1 ✓

### BIMATERIAL HANDLE INTERCHANGEABLE BIT RATCHETING STUBBY SCREWDRIVER



**MAGNETIC BIT HOLDER** **RATCHET SYSTEM**

**7 IN ONE**



- Bits made of S2 steel.
- Bit storage system in the handle.
- Stubby type, designed to access tight spaces.
- Exceeds ASME B107.600 standard.

Tip	Description	Length	Pieces
Slotted	1/4", 3/16"	1"	2
Phillips®	PH1, PH2	1"	2
Torx®	T15, T20	1"	2
Nut driver	1/4"		1

ITEM	DESCRIPTION	AVAILABLE
9308S	Ratcheting 7 in 1, stubby	1 ✓

### RACK WITH REVOLVER TYPE SCREWDRIVER



ITEM	DESCRIPTION	AVAILABLE
RADE15MS	With 20 screwdrivers code 9315MS	1 ✓

INTERCHANGEABLE BIT REVOLVER TYPE SCREWDRIVERS

INTERCHANGEABLE BIT REVOLVER TYPE SCREWDRIVER WITH CONVENTIONAL BITS



15  
IN ONE



- Bits made of S2 steel.
- Ergonomic, soft handle to increase strength and comfort during use.
- Shaft hole functions as a 1/4" hex nut driver.

Tip	Description	Length	Pieces
Slotted	4, 6	2"	2
Phillips®	PH0, PH1, PH2, PH3	2"	4
Hex	1/8", 5/32"	2"	2
Torx®	T10, T15, T20, T25, T27, T30	2"	6
Nut driver	1/4"	N/A	

ITEM	DESCRIPTION	⊞	AVAILABLE
9315MS	15 en 1	1	✓

INTERCHANGEABLE BIT REVOLVER TYPE SCREWDRIVER WITH AUTO/HVAC



14  
IN ONE



- Bits made of S2 steel.
- Ergonomic handle designed with a non-slip grip for use in environments involving grease and oil.
- Nylon coating.
- Includes the most common bits used in the refrigeration and air conditioning industry.

Tip	Description	Length	Pieces
Slotted	5, 5	2"	1
Phillips®	PH1, PH2	2"	2
Torx®	T9, T10, T15, T20, T25, T27, T30, T40	2"	8
Schrader valve		2"	1
Adapter	Socket adapter.	2"	1
Nut driver	1/4"	N/A	

ITEM	DESCRIPTION	⊞	AVAILABLE
9314MS	14 en 1	1	✓

INTERCHANGEABLE BIT REVOLVER TYPE SCREWDRIVER WITH SPANNER AND TAMPER BITS



15  
IN ONE



- Bits made of S2 steel.
- Ergonomic handle designed with a non-slip grip for use in environments involving grease and oil.
- Nylon coating.
- Includes bits for removing the most commonly used security screws in the electrical, telecommunications, and locksmith industries.

Tip	Description	Length	Pieces
Spanner	6, 8, 10, 12	2"	4
Hex tamper	1/8", 9/64", 5/32", 3/16"	2"	4
Torx® Tamper	T10, T15, T20, T25, T27, T30	2"	6
Nut driver	1/4"	N/A	

ITEM	DESCRIPTION	⊞	AVAILABLE
9315MT	15 en 1	1	✓

INTERCHANGEABLE BIT SCREWDRIVER WITH HEX BITS



15  
IN ONE



- Bits made of S2 steel.
- Ergonomic, soft handle to increase strength and comfort during use.
- Shaft hole functions as a 1/4" hex nut driver.

TYPE	TIPS	BIT LENGTH	PIECES
Sae Hex	3/32, 7/64, 1/8, 9/64, 5/32, 3/16, 7/32, 1/4	2"	8
Metric Hex	2, 3, 4, 5, 5.5, 6mm	2"	
Nut driver	1/4" hex		1

ITEM	DESCRIPTION	⊞	AVAILABLE
9315MH	15 in 1	6	On Request

CUSHION GRIP HANDLE INTERCHANGEABLE BIT SCREWDRIVERS

CUSHION GRIP HANDLE INTERCHANGEABLE BIT SCREWDRIVER



10  
IN ONE



Tip	Description	Length	Pieces
Slotted	1/4", 5/16"	1-1/4"	2
Phillips®	PH2, PH3	1-1/4"	2
Square	1/8", 3/32"	1-1/4"	2
Torx®	T10, T15	1-1/4"	2
Nut driver	3/16", 1/4"	1-1/4"	2

- Double bits with central ball detent security device to prevent them from falling during use.
- Shaft hole functions as a hex nut driver.
- Cushion grip handle for enhanced comfort, providing a better grip and allowing higher torque application.

ITEM	LENGTH TOTAL	⊞	AVAILABLE
9310CMS	7-1/4"	1	✓

6  
IN ONE



Tip	Description	Length	Pieces
Slotted	3/16", 5/16"	2-3/4"	2
Phillips®	PH1, PH2	2-3/4"	2
Nut driver	1/4", 5/16"	2-3/4"	2

ITEM	LENGTH TOTAL	⊞	AVAILABLE
9302CMS	7-1/4"	1	✓



5  
IN ONE



Tip	Description	Length	Pieces
Slotted	3/16", 5/16"	2-3/4"	2
Phillips®	PH1, PH2	2-3/4"	2
Nut driver	5/16"	2-3/4"	1

ITEM	LENGTH TOTAL	⊞	AVAILABLE
9301CMS	7-1/4"	1	✓

## AMBER HANDLE INTERCHANGEABLE BIT SCREWDRIVERS

### AMBER HANDLE 1/4" HEXAGONAL MAGNETIC INTERCHANGEABLE BIT SCREWDRIVER



**10 IN ONE** MAGNETIC BIT HOLDER



- High-strength transparent plastic handle.
- Shaft hole functions as a 1/4" hex nut driver.

Tip	Description	Pieces
Slotted	6F-8R, 8F-10R, 10F-12R	4
Phillips®	PH1, PH2, PH3	3
Torx®	T15, T20, T25	3
Nut driver	5/16"	1

ITEM	OPENING SIZE	EXPOSED LENGTH	TOTAL LENGTH	⊞	AVAILABLE
9308	1/4"	7-7/8"	3-1/2"	1	✓

### AMBER HANDLE 1/4" HEXAGONAL MAGNETIC INTERCHANGEABLE BIT SCREWDRIVER



- High-strength transparent plastic handle.
- Shaft hole functions as a 1/4" hex nut driver.

ITEM	OPENING SIZE	EXPOSED LENGTH	TOTAL LENGTH	⊞	AVAILABLE
9300MS	1/4"	7-7/8"	3-1/2"	6	✓

### BLUE HANDLE 1/4" HEXAGONAL MAGNETIC INTERCHANGEABLE BIT SCREWDRIVER



- High-strength transparent plastic handle.
- Shaft hole functions as a 1/4" hex nut driver.

ITEM	OPENING SIZE	EXPOSED LENGTH	TOTAL LENGTH	⊞	AVAILABLE
D300	1/4"	7"	3"	6	✓

## BIMATERIAL HANDLE PRECISION SCREWDRIVERS

### ESD BIMATERIAL PRECISION HANDLE SCREWDRIVERS

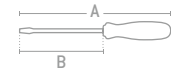

- Made of chrome vanadium steel.
- Rotating cap for greater precision.
- Color-coded ring for tip type identification.
- Shaft markings for easy size selection.
- Exceed ASME B107.33M, ISO 2380-1, and ISO 8764-1 standards.

- **Gray material:** High-strength PE plastic prevents shaft from rotating.
- **Black material:** Soft TPE plastic for improved torque transmission and better grip.

ITEM	TYPE TIP	TIP SIZE	TOTAL LENGTH (A)	EXPOSED LENGTH (B)	⊞	AVAILABLE
9503B	Slotted	3/64"	6-3/32"	2-3/8"	1	✓
9504B	Slotted	1/16"	6-3/32"	2-3/8"	1	✓
9505B	Slotted	9/128"	6-3/32"	2-3/8"	1	✓
9506B	Slotted	5/64"	6-3/32"	2-3/8"	1	✓
9507B	Slotted	13/128"	6-11/16"	2-15/16"	1	✓
9508B	Slotted	15/128"	6-11/16"	2-15/16"	1	✓
9509B	Phillips®	PH00	6-3/32"	2-3/8"	1	✓
9510B	Phillips®	PH0	6-3/32"	2-3/8"	1	✓
9511B	Phillips®	PH1	6-7/8"	3-5/32"	1	✓
9512B	Phillips®	PH1	9-27/32"	5-29/32"	1	✓
9513B	Torx®	T5	6-3/32"	2-3/8"	1	✓
9514B	Torx®	T6	6-3/32"	2-3/8"	1	✓
9515B	Torx®	T7	6-3/32"	2-3/8"	1	✓
9516B	Torx®	T8	6-3/32"	2-3/8"	1	✓
9517B	Torx®	T9	6-3/32"	2-3/8"	1	✓
9518B	Torx®	T10	6-7/8"	3-5/32"	1	✓

### SCREWDRIVER SETS

ITEM	9501BC	9500BC	9501BG	9500BG	9500BF	9501BT	9500BT
PIECES	6	5	6	5	4	6	5
PACKING							
⊞	1	1	1	1	1	1	1
AVAILABLE	✓	✓	✓	✓	✓	✓	✓



**BIMATERIAL HANDLE PRECISION SCREWDRIVERS**

**INTERCHANGEABLE BIT PRECISION SCREWDRIVER SET**



**32  
PIECES**



- Bits made of chrome molybdenum steel.
- Non-slip handle for improved grip.
- Rotating cap for greater precision.
- Extension for working in hard-to-reach areas.

Tip	Description	Pieces
⊖ Slotted	1, 1.5, 2, 2.5, 3, 3.5, 4 mm	7
⊕ Phillips®	PH000, PH00, PH0, PH1	4
★ Torx®	T4, T5, T6, T7, T8, T9, T10, T15, T20	9
● Hex	0.7, 0.9, 1.3, 1.5, 2, 2.5, 3, 4 mm	8
⊕ Pozidriv	PZ0, PZ1	2
Handle	Anti-slip with swivel head	1
Extension		1



ITEM	PIECES	📦	AVAILABLE
DJY04	32	1	✓

**PRECISION SCREWDRIVER SET**



**15  
PIECES**



- Bits made of chrome vanadium steel.
- Non-slip handle for improved grip.
- Rotating cap for greater precision.
- Ideal for eyeglasses, watches, cameras, computers, and other small items.

Tip	Description	Pieces
⊖ Slotted	1.4, 1.8, 2.4 mm	3
⊕ Phillips®	PH00, PH0, PH1	3
★ Torx®	T5, T6, T7, T8, T9, T10	6
● Hexa	1.5, 2, 2.5 mm	3



ITEM	PIECES	📦	AVAILABLE
DJY03	15	1	On Request

**JUEGO DE PRECISION SCREWDRIVER SET FOR JEWELERO**



**6  
PIECES**



- Bits made of chrome vanadium steel.
- Non-slip handle for improved grip.
- Rotating cap for greater precision.
- Ideal for eyeglasses, watches, cameras, computers, and other small items.

Tip	Description	Pieces
⊖ Slotted	1.4, 2, 2.4, 3 mm	4
⊕ Phillips®	PH0, PH1	2



ITEM	PIECES	📦	AVAILABLE
DJY01	6	1	On Request

**COMBINATION ELECTRONIC REPAIR TOOL SET**

**COMBINATION ELECTRONIC REPAIR TOOL SET**



**117  
PIECES**



- Ideal for repairing cell phones, game consoles, laptops, and other popular electronic devices.

Tip	Description	Length	Pieces	Accessories	Pieces
⊖ Slotted	SL1 x 2, SL1.3 x 2, SL1.5 x 2, SL2 x 2, SL2.5 x 2, SL3, SL3.5, SL4	28 mm	13	Metal extension shaft	1
⊕ Phillips®	PH0000 x 2, PH000 x 2, PH00 x 2, PH0 x 2, PH1 x 2, PH2 x 2	28 mm	12	Screwdriver	1
⊕ Phillips® Pinhead	PH 2.5	28 mm	1	Plastic extension	1
● Hex	0.7, 0.9, 1.0, 1.3, 1.5, 2.0, 2.5, 3.0, 3.5, 4.0, 4.5, 5.0, 6.0	28 mm	13	Curved tweezer	1
★ Torx®	T1, T2, T3, T4, T5, T6, T7, T8, T9, T10, T15, T20	28 mm	12	Plastic pry tool	3
★ Tamper Torx®	T6H, T7H, T8H, T9H, T10H, T15H, T20H, T25H	28 mm	8	Adapter 1/4"	1
⊖ Tip de caja	M 2.5, M 3.0, M 3.5, M 4.0, M 4.5, M 5.0, M 5.5	28 mm	7	Magnetizer	1
■ Square	#0 (2.0 mm), #1 (2.5 mm), #2 (3.0 mm)	28 mm	3	Suction cup	1
⊕ Spanner	2.3, 2.6, 8.0	28 mm	3	SIM pick needle	1
⊕ Triwing	0.6 x 2, 1.5 x 2, 2.0, 2.3, 3.0	28 mm	7	Thin triangle pick	4
▲ Triangular	2.0, 2.3, 2.7, 3.0	28 mm	4	Thick triangle pick	4
★ Pentabolular	0.8 x 2, 1.2 x 2, 1.5, 2.0	28 mm	6		
⊕ Pozidriv	PZ000, PZ00, PZ0, PZ1, PZ2	28 mm	5		
○ SIM	0.8	28 mm	1		
● Gamebit	G3.8, G4.5	28 mm	2		

ITEM	PIECES	BIT LENGTH	BIT DIAMETER	📦	AVAILABLE
JDPU117	117	28 mm	5/32"	1	On Request



## COLOR CODING

**INCHES**  
 Red handle. Length 9" and 6".  
 Tips:



**METRIC**  
 Blue handle. Length 9" and 6".  
 Tips:



**TORX®**  
 Green handle. Length 6".  
 Tips:

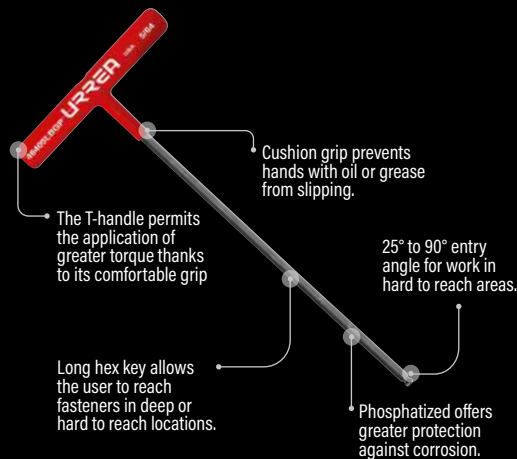

# "T" TYPE HEX KEYS.

## TYPE TIPS

- BALL END TIP** 25° to 90° entry angle for work in hard to reach areas.
- HEX BIT** 90° prevents damaging fasteners.
- TORX® BIT** Special design for Torx fasteners, widely used in the automotive industry.

### ERGONOMIC BALL END T-HANDLE HEXAGONAL KEYS



ITEM	HEX KEY SETS	
	4967LBGP	4965LBGPM
PIECES	11	10
PACKING		
<b>BULK</b>	1	1
AVAILABLE	✓	✓

• Exceed ASME B18.3 and ISO 2936L standards.

ITEM	TIP	TIP SIZE	LENGTH (A)	HANDLE SIZE (B)	⊗	AVAILABLE
46405LBGP	Red	5/64"	9"	3"	4	✓
46406LBGP	Red	3/32"	9"	3"	4	✓
46407LBGP	Red	7/64"	9"	3"	4	✓
46408LBGP	Red	1/8"	9"	3"	4	✓
46409LBGP	Red	9/64"	9"	3"	4	✓
46410LBGP	Red	5/32"	9"	3"	4	✓
46412LBGP	Red	3/16"	9"	4"	4	✓
46414LBGP	Red	7/32"	9"	4"	4	✓
46416LBGP	Red	1/4"	9"	4"	4	✓
46420LBGP	Red	5/16"	9"	5"	2	✓
46424LBGP	Red	3/8"	9"	5"	2	✓
46508LBGP	Blue	2 mm	9"	3"	4	✓
46510LBGP	Blue	2.5 mm	9"	3"	4	✓
46512LBGP	Blue	3 mm	9"	3"	4	✓
46514LBGP	Blue	4 mm	9"	3"	4	✓
46516LBGP	Blue	5 mm	9"	3"	4	✓
46518LBGP	Blue	6 mm	9"	4"	4	✓
46519LBGP	Blue	7 mm	9"	4"	2	✓
46520LBGP	Blue	8 mm	9"	4"	2	✓
46521LBGP	Blue	9 mm	9"	5"	2	✓
46522LBGP	Blue	10 mm	9"	5"	2	✓



**T-HANDLE HEXAGONAL KEYS**

**ERGONOMIC LONG T-HANDLE HEXAGONAL KEYS**



46416LGP



46520LGP

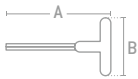

• Exceed ASME B18.3 and ISO 2936L standards.

ITEM	HEX KEY SETS	
	4967LGP	4965LGPM
PIECES	11	10
PACKING		
	1	1

**BULK**

ITEM	TIP	TIP SIZE	LENGTH (A)	HANDLE SIZE (B)		AVAILABLE
46405LGP	Red	5/64"	9"	3"	4	✓
46406LGP	Red	3/32"	9"	3"	4	✓
46407LGP	Red	7/64"	9"	3"	4	✓
46408LGP	Red	1/8"	9"	3"	4	✓
46409LGP	Red	9/64"	9"	3"	4	✓
46410LGP	Red	5/32"	9"	3"	4	✓
46412LGP	Red	3/16"	9"	4"	4	✓
46414LGP	Red	7/32"	9"	4"	4	✓
46416LGP	Red	1/4"	9"	4"	4	✓
46420LGP	Red	5/16"	9"	5"	4	✓
46424LGP	Red	3/8"	9"	5"	2	✓
46508LGP	Blue	2 mm	9"	3"	4	✓
46510LGP	Blue	2.5 mm	9"	3"	4	✓
46512LGP	Blue	3 mm	9"	3"	4	✓
46514LGP	Blue	4 mm	9"	3"	4	✓
46516LGP	Blue	5 mm	9"	3"	4	✓
46518LGP	Blue	6 mm	9"	4"	4	✓
46519LGP	Blue	7 mm	9"	4"	2	✓
46520LGP	Blue	8 mm	9"	4"	2	✓
46521LGP	Blue	9 mm	9"	5"	2	✓
46522LGP	Blue	10 mm	9"	5"	2	✓

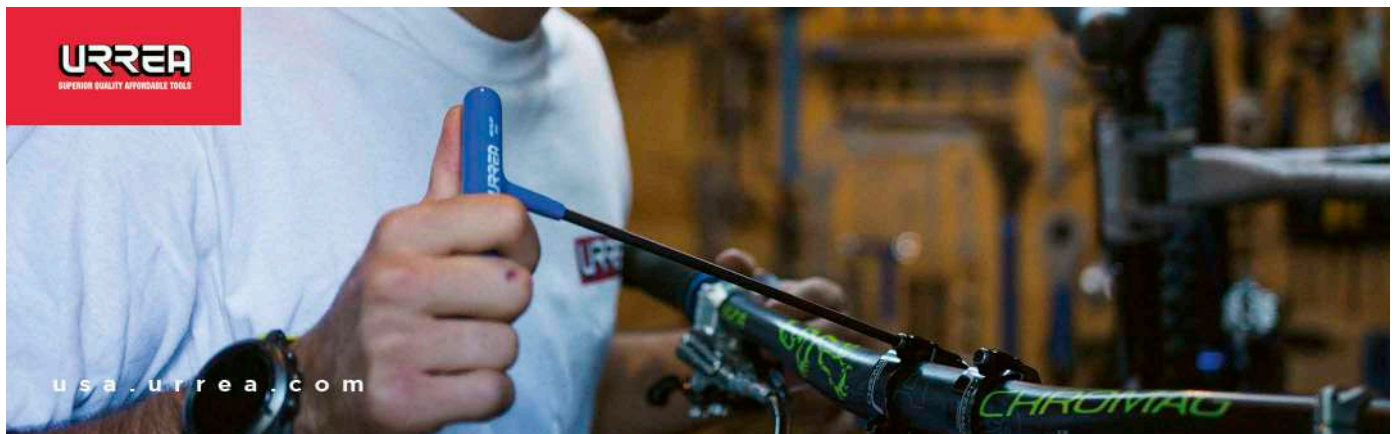

usa.urrea.com

## T-HANDLE HEXAGONAL KEYS

### ERGONOMIC SHORT T-HANDLE HEXAGONAL KEYS

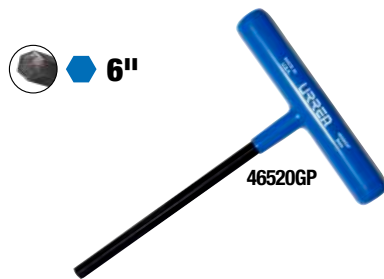
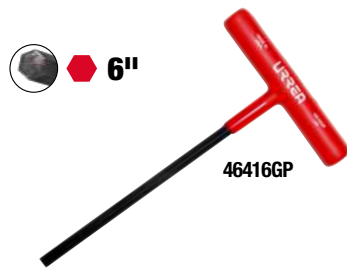

DRIVERS TOOLS

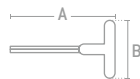

• Exceed ASME B18.3 and ISO 2936L standards.

**BULK**

ITEM	HEX KEY SETS		
	4967GP	4965GPM	49668TGP
PIECES	11	10	13
PACKING			

ITEM	4967GP	4965GPM	49668TGP
AVAILABLE	✓	✓	✓

ITEM	TIP	TIP SIZE	LENGTH (A)	HANDLE SIZE (B)	QTY	AVAILABLE	4967GP	4965GPM	49668TGP
46405GP	Hex	5/64"	6"	3"	4	✓	•		
46406GP	Hex	3/32"	6"	3"	4	✓	•		
46407GP	Hex	7/64"	6"	3"	4	✓	•		
46408GP	Hex	1/8"	6"	3"	4	✓	•		
46409GP	Hex	9/64"	6"	3"	4	✓	•		
46410GP	Hex	5/32"	6"	3"	4	On Request	•		
46412GP	Hex	3/16"	6"	4"	4	On Request	•		
46414GP	Hex	7/32"	6"	4"	4	✓	•		
46416GP	Hex	1/4"	6"	4"	4	✓	•		
46420GP	Hex	5/16"	6"	5"	2	✓	•		
46424GP	Hex	3/8"	6"	5"	2	✓	•		
46508GP	Hex	2 mm	6"	3"	4	✓		•	
46510GP	Hex	2.5 mm	6"	3"	4	✓		•	
46512GP	Hex	3 mm	6"	3"	4	✓		•	
46514GP	Hex	4 mm	6"	3"	4	✓		•	
46516GP	Hex	5 mm	6"	3"	4	✓		•	
46518GP	Hex	6 mm	6"	4"	4	✓		•	
46519GP	Hex	7 mm	6"	4"	2	✓		•	
46520GP	Hex	8 mm	6"	4"	2	✓		•	
46521GP	Hex	9 mm	6"	5"	2	✓		•	
46522GP	Hex	10 mm	6"	5"	2	✓		•	
467T6GP	Torx	T6	6"	3"	4	✓			•
467T7GP	Torx	T7	6"	3"	4	✓			•
467T8GP	Torx	T8	6"	3"	4	✓			•
467T9GP	Torx	T9	6"	3"	4	✓			•
467T10GP	Torx	T10	6"	3"	4	✓			•
467T15GP	Torx	T15	6"	3"	4	✓			•
467T20GP	Torx	T20	6"	3"	4	✓			•
467T25GP	Torx	T25	6"	3"	4	✓			•
467T27GP	Torx	T27	6"	4"	4	✓			•
467T30GP	Torx	T30	6"	4"	4	✓			•
467T40GP	Torx	T40	6"	4"	4	✓			•
467T45GP	Torx	T45	6"	5"	2	✓			•
467T50GP	Torx	T50	6"	5"	2	✓			•

T-HANDLE HEXAGONAL KEYS

VINYL GRIP T-HANDLE HEXAGONAL KEYS

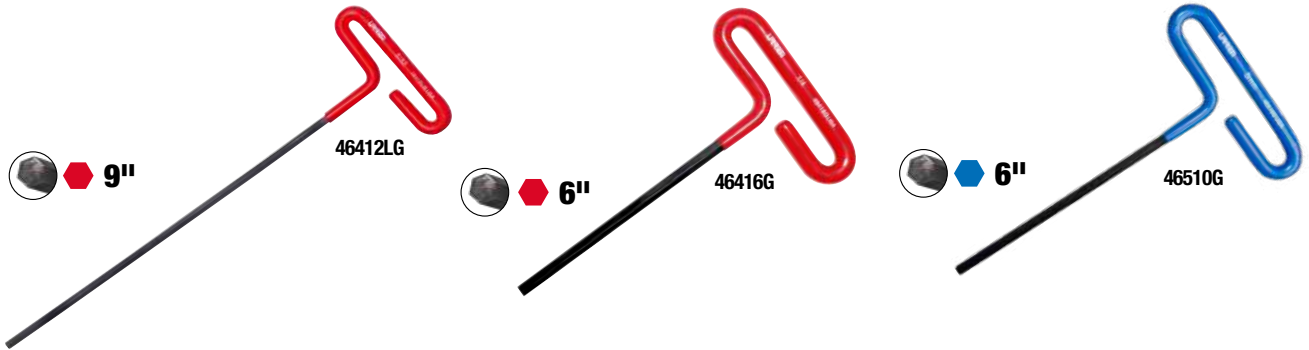

DRIVERS TOOLS

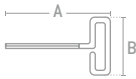

• Exceed ASME B18.3 and ISO 2936L standards.

ITEM	TIP	TIP SIZE	LENGTH (A)	HANDLE SIZE (B)	PKGS	AVAILABLE	HEX KEY SETS	
							4965G	4966G
							10	8
							1	1
							✓	✓
46412LG	●	3/16"	9"	4"	12	✓		
46416LG	●	1/4"	9"	4"	6	✓		
46420LG	●	5/16"	9"	6"	6	✓		
46424LG	●	3/8"	9"	6"	6	✓		
46406G	●	3/32"	6"	3"	12	✓	•	
46407G	●	7/64"	6"	3"	12	✓	•	
46408G	●	1/8"	6"	3"	12	✓	•	
46409G	●	9/64"	6"	3"	12	✓	•	
46410G	●	5/32"	6"	3"	12	✓	•	
46412G	●	3/16"	6"	3"	12	✓	•	
46414G	●	7/32"	6"	4"	6	✓	•	
46416G	●	1/4"	6"	4"	6	✓	•	
46420G	●	5/16"	6"	4"	6	✓	•	
46424G	●	3/8"	6"	4"	6	✓	•	
46508G	●	2 mm	6"	3"	6	✓		•
46510G	●	2.5 mm	6"	3"	6	✓		•
46512G	●	3 mm	6"	3"	6	✓		•
46514G	●	4 mm	6"	3"	6	✓		•
46516G	●	5 mm	6"	3"	6	✓		•
46518G	●	6 mm	6"	3"	6	✓		•
46520G	●	8 mm	6"	4"	6	✓		•
46522G	●	10 mm	6"	4"	6	✓		•

**BULK**

## T-HANDLE HEXAGONAL KEYS

### SHORT T-HANDLE HEXAGONAL KEYS

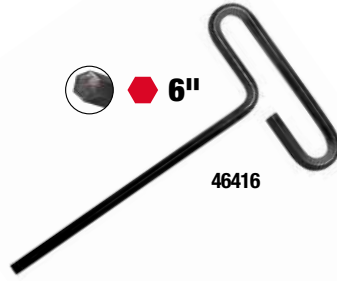

46416

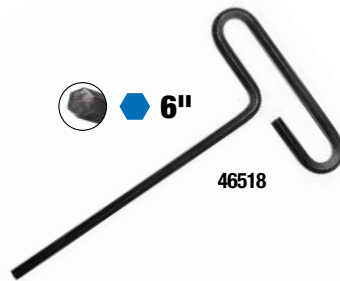

46518

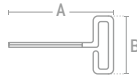

• Exceed ASME B18.3 and ISO 2936L standards.

#### BULK

ITEM	TIP	TIP SIZE	LENGTH (A)	HANDLE SIZE (B)	Ø	HEX KEY SETS	
						4965	4966
						PIECES	10
						PACKING	
						AVAILABLE	1
46406	Red	3/32"	6"	2-3/4"	12	✓	•
46407	Red	7/64"	6"	2-3/4"	12	On Request	•
46408	Red	1/8"	6"	3"	12	✓	•
46409	Red	9/64"	6"	3"	12	✓	•
46410	Red	5/32"	6"	3"	12	✓	•
46412	Red	3/16"	6"	4"	6	✓	•
46414	Red	7/32"	6"	4"	6	✓	•
46416	Red	1/4"	6"	4"	6	✓	•
46420	Red	5/16"	6"	6"	6	✓	•
46424	Red	3/8"	6"	6"	6	✓	•
46508	Blue	2 mm	6"	2-3/4"	6	✓	•
46510	Blue	2.5 mm	6"	2-3/4"	6	✓	•
46512	Blue	3 mm	6"	3"	6	✓	•
46514	Blue	4 mm	6"	3"	6	✓	•
46516	Blue	5 mm	6"	4"	6	✓	•
46518	Blue	6 mm	6"	4"	6	✓	•
46520	Blue	8 mm	6"	6"	6	✓	•
46522	Blue	10 mm	6"	6"	6	✓	•

## HEX KEY SETS

### COLOR CODING

#### INCHES

Red rack. Standard and long keys. Tips:



#### METRIC

Blue rack. Standard and long keys. Tips:



#### TORX®

Green rack. Standard and long keys. Tips:



# L - TYPE HEX KEYS.

## HEAVY-DUTY HEX KEYS FEATURES

Manufactured with alloy steel with up to 40% more resistant.

Hardened with heat treatment to prevent any fracture.

Chamfered tips for a quick and perfect fit.

Exceeds ASME B18.3 and ISO 2936L standards.

### TYPE TIPS



**BALL END TIP**

25° entry angle for work in hard-to-reach areas.



**HEX BIT**

## INDUSTRIAL-DUTY HEX KEYS FEATURES

Manufactured with chrome-vanadium steel.

Chamfered tips for a quick and perfect fit.

Works at angles up to 25°.

Exceeds ASME B18.3 and ISO 2936L standards.

Chamfered tips for faster insertion and full tool engagement in the screw head.

## PROFESSIONAL-USE HEX KEYS FEATURES

Manufactured with chrome-vanadium steel.

Works at angles up to 25°.

Exceeds ASME B18.3 and ISO 2936L standards.



**TORX® BIT**

Special design for Torx fasteners, widely used in the automotive industry.

**HEX KEY SETS**

**COMBINATION BALL-END L-TYPE HEX KEY SETS**



- Made of alloy steel for up to 40% more strength.
- Chamfered tips allow quick engagement with the screw.
- Operates at angles up to 25°.
- Exceeds ASME B18.3 and ISO 2936L standards.

Type	Tip size	Pieces
● Hex	0.05", 1/16", 5/64", 3/32", 7/64", 1/8", 9/64", 5/32", 3/16", 7/32", 1/4", 5/16", 3/8"	13
● Hex	1.5 mm, 2 mm, 2.5 mm, 3 mm, 4 mm, 5 mm, 6 mm, 8 mm, 10 mm	9

ITEM	PIECES	🔗	AVAILABLE
<b>49822HD</b>	22	1	On Request



- Made of chrome vanadium steel.
- Chamfered tips allow quick engagement with the screw.
- Operates at angles up to 25°.
- Exceeds ASME B18.3 and ISO 2936L standards.

Type	Tip size	Pieces
● Hex	0.05", 1/16", 5/64", 3/32", 7/64", 1/8", 9/64", 5/32", 3/16", 7/32", 1/4", 5/16", 3/8"	13
● Hex	1.5 mm, 2 mm, 2.5 mm, 3 mm, 4 mm, 5 mm, 6 mm, 8 mm, 10 mm	9

ITEM	PIECES	🔗	AVAILABLE
<b>49822</b>	22	1	✓

**SAE BALL-END L-TYPE HEX KEY SETS**



- Made of alloy steel for up to 40% more strength.
- Chamfered tips allow quick engagement with the screw.
- Operates at angles up to 25°.
- Exceeds ASME B18.3 and ISO 2936L standards.

Type	Tip size	Pieces
● Hex	0.05", 1/16", 5/64", 3/32", 7/64", 1/8", 9/64", 5/32", 3/16", 7/32", 1/4", 5/16", 3/8"	13

ITEM	PIECES	🔗	AVAILABLE
<b>4995HD</b>	13	1	On Request



- Made of chrome vanadium steel.
- Chamfered tips allow quick engagement with the screw.
- Operates at angles up to 25°.
- Exceeds ASME B18.3 and ISO 2936L standards.

Type	Tip size	Pieces
● Hex	0.05", 1/16", 5/64", 3/32", 7/64", 1/8", 9/64", 5/32", 3/16", 7/32", 1/4", 5/16", 3/8"	13

ITEM	PIECES	🔗	AVAILABLE
<b>4995</b>	13	1	✓

**METRIC BALL-END L-TYPE HEX KEY SETS**



- Made of alloy steel for up to 40% more strength.
- Chamfered tips allow quick engagement with the screw.
- Operates at angles up to 25°.
- Exceeds ASME B18.3 and ISO 2936L standards.

Type	Tip size	Pieces
● Hex	1.5 mm, 2 mm, 2.5 mm, 3 mm, 4 mm, 5 mm, 6 mm, 8 mm, 10 mm	9

ITEM	PIECES	🔗	AVAILABLE
<b>4996HD</b>	9	1	On Request



- Made of chrome vanadium steel.
- Chamfered tips allow quick engagement with the screw.
- Operates at angles up to 25°.
- Exceeds ASME B18.3 and ISO 2936L standards.

Type	Tip size	Pieces
● Hex	1.5 mm, 2 mm, 2.5 mm, 3 mm, 4 mm, 5 mm, 6 mm, 8 mm, 10 mm	9

ITEM	PIECES	🔗	AVAILABLE
<b>4996</b>	9	1	✓

## HEX KEY SETS

### COMBINATION L-TYPE HEX KEY SETS

PROFESSIONAL USE

INCHES

METRIC



30  
PIECES



- Made of chrome vanadium steel.
- Operates at angles up to 25°.
- Complies with ASME B18.3 and ISO 2936L standards.

Type	Tip size	Pieces
Hex	0.028", 0.035", 0.050", 1/16", 5/64", 3/32", 7/64", 1/8", 9/64", 5/32", 3/16", 7/32", 1/4", 5/16", 3/8"	15
Hex	0.7 mm, 0.9 mm, 1.3 mm, 1.5 mm, 2 mm, 2.5 mm, 3 mm, 4 mm, 4.5 mm, 5 mm, 5.5 mm, 6 mm, 7 mm, 8 mm, 10 mm	15

ITEM	PIECES	⊞	AVAILABLE
ALLF30	30	1	On Request

PROFESSIONAL USE

INCHES

METRIC



25  
PIECES

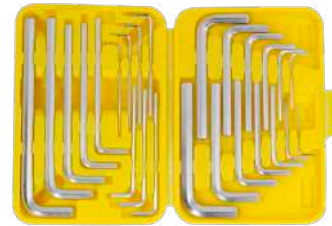

- Made of chrome vanadium steel.
- Operates at angles up to 25°.
- Complies with ASME B18.3 and ISO 2936L standards.

Type	Tip size	Pieces
Hex	1/16", 5/64", 3/32", 7/64", 1/8", 9/64", 5/32", 3/16", 7/32", 1/4", 5/16", 3/8"	12
Hex	1.5 mm, 2 mm, 2.5 mm, 3 mm, 4 mm, 4.5 mm, 5 mm, 5.5 mm, 6 mm, 7 mm, 8 mm, 9 mm, 10 mm	13

ITEM	PIECES	⊞	AVAILABLE
ALLF25	25	1	On Request

SURTEK  
TOOLS FOR SPECIALISTS



DRIVERS TOOLS

### SAE LONG L-TYPE HEX KEY SETS

HEAVY DUTY

INCHES



13  
PIECES



4972RHD

- Made of alloy steel providing up to 40% more strength.
- Chamfered tips allow quick engagement with the screw.
- Exceed ASME B18.3 and ISO 2936L standards.

Type	Tip size	Pieces
Hex	0.05", 1/16", 5/64", 3/32", 7/64", 1/8", 9/64", 5/32", 3/16", 7/32", 1/4", 5/16", 3/8"	13

ITEM	PIECES	⊞	AVAILABLE
4972RHD	13	1	On Request

INDUSTRIAL DUTY

INCHES



13  
PIECES



4972R

- Made of chrome vanadium steel.
- Chamfered tips allow quick engagement with the screw.
- Exceed ASME B18.3 and ISO 2936L standards.

Type	Tip size	Pieces
Hex	0.05", 1/16", 5/64", 3/32", 7/64", 1/8", 9/64", 5/32", 3/16", 7/32", 1/4", 5/16", 3/8"	13

ITEM	PIECES	⊞	AVAILABLE
4972R	13	1	✓

URREA  
SUPERIOR QUALITY AFFORDABLE TOOLS



### METRIC LONG L-TYPE HEX KEY SETS

HEAVY DUTY

METRIC



9  
PIECES



4972MHD

- Made of alloy steel providing up to 40% more strength.
- Chamfered tips allow quick engagement with the screw.
- Exceed ASME B18.3 and ISO 2936L standards.

Type	Tip size	Pieces
Hex	2 mm, 2.5 mm, 3 mm, 4 mm, 5 mm, 6 mm, 8 mm, 10 mm	9

ITEM	PIECES	⊞	AVAILABLE
4972MHD	9	1	On Request

INDUSTRIAL DUTY

METRIC



9  
PIECES



4972M

- Made of chrome vanadium steel.
- Chamfered tips allow quick engagement with the screw.
- Exceed ASME B18.3 and ISO 2936L standards.

Type	Tip size	Pieces
Hex	2 mm, 2.5 mm, 3 mm, 4 mm, 5 mm, 6 mm, 8 mm, 10 mm	9

ITEM	PIECES	⊞	AVAILABLE
4972M	9	1	✓

URREA  
SUPERIOR QUALITY AFFORDABLE TOOLS





**HEX KEY SETS**

**SAE SHORT L-TYPE HEX KEY SETS**



**URREA**  
INDUSTRIAL DUTY



**12**  
PIECES



**4972**

Type	Tip size	Pieces
Hex	0.05", 1/16", 5/64", 3/32", 7/64", 1/8", 9/64", 5/32", 3/16", 7/32", 1/4", 5/16", 3/8"	12

- Made of chrome vanadium steel.
- Chamfered tips allow quick engagement with the screw.
- Exceed ASME B18.3 and ISO 2936L standards.

ITEM	PIECES	☐	AVAILABLE
<b>4972</b>	12	1	✓

**11**  
PIECES



**4975**

Type	Tip size	Pieces
Hex	5/64", 3/32", 7/64", 1/8", 9/64", 5/32", 3/16", 7/32", 1/4", 5/16", 3/8"	11

ITEM	PIECES	☐	AVAILABLE
<b>4975</b>	11	1	✓

**7**  
PIECES



**4977**

Type	Tip size	Pieces
Hex	5/64", 3/32", 1/8", 5/32", 3/16", 7/32", 1/4"	7

ITEM	PIECES	☐	AVAILABLE
<b>4977</b>	7	1	✓

**BULK**

**SAE SHORT L-TYPE HEX KEY SETS**



**SURTEK**  
TOOLS FOR PROFESSIONALS



**13**  
PIECES



**ALLF13**

Type	Tip size	Pieces
Hex	0.05", 1/16", 5/64", 3/32", 7/64", 1/8", 9/64", 5/32", 3/16", 7/32", 1/4", 5/16", 3/8"	13

- Made of chrome vanadium steel.
- Complies with ASME B18.3 and ISO 2936L standards.

ITEM	PIECES	☐	AVAILABLE
<b>ALLF13</b>	13	1	On Request

**10**  
PIECES



**ALLF10**

Type	Tip size	Pieces
Hex	1/16", 5/64", 3/32", 1/8", 5/32", 3/16", 7/32", 1/4", 5/16", 3/8"	10

ITEM	PIECES	☐	AVAILABLE
<b>ALLF10</b>	10	1	On Request

**7**  
PIECES



**ALLF7**

Type	Tip size	Pieces
Hex	1/16", 5/64", 3/32", 1/8", 5/32", 3/16", 1/4"	7

ITEM	PIECES	☐	AVAILABLE
<b>ALLF7</b>	7	1	On Request

**RACK**

**METRIC SHORT L-TYPE HEX KEY SETS**



**URREA**  
INDUSTRIAL DUTY



**11**  
PIECES



**4976A**

Type	Tip size	Pieces
Hex	1.5 mm, 2 mm, 2.5 mm, 3 mm, 4 mm, 5 mm, 6 mm, 7 mm, 8 mm, 9 mm, 10 mm	11

- Made of chrome vanadium steel.
- Chamfered tips allow quick engagement with the screw.
- Exceed ASME B18.3 and ISO 2936L standards.

ITEM	PIECES	☐	AVAILABLE
<b>4976A</b>	11	1	✓

**10**  
PIECES



**4975M**

Type	Tip size	Pieces
Hex	1.27 mm, 1.5 mm, 2 mm, 2.5 mm, 3 mm, 4 mm, 5 mm, 6 mm, 8 mm, 10 mm	10

ITEM	PIECES	☐	AVAILABLE
<b>4975M</b>	10	1	✓

**7**  
PIECES



**4977M**

Type	Tip size	Pieces
Hex	2 mm, 2.5 mm, 3 mm, 4 mm, 5 mm, 6 mm, 8 mm	7

ITEM	PIECES	☐	AVAILABLE
<b>4977M</b>	7	1	✓

**BULK**

## HEX KEY SETS

### METRIC L-TYPE HEX KEY SETS



**13**  
PIECES



**ALLF13M**

Type	Tip size	Pieces
● Hex	1.3 mm, 1.5 mm, 2 mm, 2.5 mm, 3 mm, 3.5 mm, 4 mm, 4.5 mm, 5 mm, 5.5 mm, 6 mm, 8 mm, 10 mm	13

- Made of chrome vanadium steel.
- Complies with ASME B18.3 and ISO 2936L standards.

ITEM	PIECES	AVAILABLE
ALLF13M	13	On Request

**10**  
PIECES



**ALLF10M**

Type	Tip size	Pieces
● Hex	1.5 mm, 2 mm, 2.5 mm, 3 mm, 5 mm, 5.5 mm, 6 mm, 8 mm, 9 mm, 10 mm	10

ITEM	PIECES	AVAILABLE
ALLF10M	10	On Request

**7**  
PIECES



**ALLF7M**

Type	Tip size	Pieces
● Hex	1.5 mm, 2 mm, 2.5 mm, 3 mm, 4 mm, 5 mm, 6 mm	7

ITEM	PIECES	AVAILABLE
ALLF7M	7	On Request

### TORX BALL L-TYPE HEXAGONAL KEY SETS



**7**  
PIECES



- Made of chrome vanadium steel.
- Operates at angles up to 25°.
- Exceed ASME B18.3 and ISO 2936L standards.

Type	Tip size	Pieces
★ Torx®	T10, T15, T20, T25, T27, T30, T40	7

ITEM	PIECES	AVAILABLE
4972TB	7	✓

### TORX LONG L-TYPE HEXAGONAL KEY SET



**7**  
PIECES



- Made of chrome vanadium steel.
- Exceed ASME B18.3 and ISO 2936L standards.

Type	Tip size	Pieces
★ Torx®	T10, T15, T20, T25, T27, T30, T40	7

ITEM	PIECES	AVAILABLE
4972TL	7	✓

### TORX LONG L-TYPE HEX KEY SET



**7**  
PIECES



- Made of chrome vanadium steel.
- Complies with ASME B18.3 and ISO 2936L standards.

Type	Tip size	Pieces
★ Torx®	T9, T10, T15, T20, T25, T27, T30	7

ITEM	PIECES	AVAILABLE
ALLFTL7	7	On Request

### "L" TYPE HEXAGONAL KEY SET, TORX®



**7**  
PIECES



- Made of chrome vanadium steel.
- Exceed ASME B18.3 and ISO 2936L standards.

Type	Tip size	Pieces
★ Torx®	T10, T15, T20, T25, T27, T30, T40	7

ITEM	PIECES	AVAILABLE
4972T	7	✓

### JUEGOS DE LLAVES HEXAGONALES TIPO "L" CORTAS TORX®



**9**  
PIECES



- Made of chrome vanadium steel.
- Complies with ASME B18.3 and ISO 2936L standards.

Type	Tip size	Pieces
★ Torx®	T10, T15, T20, T25, T27, T30, T40, T45, T50	9

ITEM	PIECES	AVAILABLE
ALLF9	9	On Request

### "L" TYPE HEXAGONAL KEY SET, TORX® TAMPER PROOF



**7**  
PIECES



- Made of chrome vanadium steel.
- Exceed ASME B18.3 and ISO 2936L standards.

Type	Tip size	Pieces
★ Torx®	T10, T15, T20, T25, T27, T30, T40	7

ITEM	PIECES	AVAILABLE
4972TT	7	✓

**L-TYPE HEXAGONAL KEYS**

**BALL END L-TYPE HEXAGONAL KEYS**



49-5/16BP



49-3BP



- Made of chrome vanadium steel.
- Chamfered tips allow quick engagement with the screw.
- Operates at angles up to 25°.
- Exceed ASME B18.3 and ISO 2936L standards.



**BULK**

ITEM	TIP	TIP SIZE	LENGTH (A)	HANDLE SIZE (B)	⌀	AVAILABLE
49-1/16BP	●	1/16"	3"	9/16"	10	✓
49-5/64BP	●	5/64"	3-3/16"	39/64"	10	✓
49-3/32BP	●	3/32"	3-3/8"	21/32"	10	✓
49-7/64BP	●	7/64"	3-9/16"	45/64"	10	✓
49-1/8BP	●	1/8"	3-3/4"	3/4"	10	✓
49-9/64BP	●	9/64"	3-15/16"	51/64"	10	✓
49-5/32BP	●	5/32"	4-1/8"	27/32"	10	✓
49-3/16BP	●	3/16"	4-1/2"	15/16"	10	✓
49-7/32BP	●	7/32"	4-7/8"	1"	10	✓
49-1/4BP	●	1/4"	5-1/4"	1-1/8"	10	✓
49-5/16BP	●	5/16"	6"	1-1/4"	5	✓
49-3/8BP	●	3/8"	6-3/4"	1-3/8"	5	✓
49-7/16BP	●	7/16"	7-1/2"	1-1/2"	5	✓
49-1/2BP	●	1/2"	8-1/4"	1-5/8"	5	On Request
49-5/8BP	●	5/8"	9"	1-3/4"	5	✓
49-3/4BP	●	3/4"	9-3/4"	1-7/8"	5	✓

ITEM	TIP	TIP SIZE	LENGTH (A)	HANDLE SIZE (B)	⌀	AVAILABLE
49-1.5BP	●	1.5 mm	3"	1/2"	10	✓
49-2BP	●	2 mm	3-3/16"	39/64"	10	✓
49-2.5BP	●	2.5 mm	3-1/2"	11/16"	10	✓
49-3BP	●	3 mm	3-7/8"	3/4"	10	✓
49-4BP	●	4 mm	4"	15/16"	10	✓
49-5BP	●	5 mm	4-9/16"	1-1/16"	10	✓
49-6BP	●	6 mm	5-7/16"	1-7/32"	10	✓
49-7BP	●	7 mm	6-1/4"	1-3/8"	5	✓
49-8BP	●	8 mm	6-1/4"	1-3/8"	5	✓
49-9BP	●	9 mm	6-9/16"	1-35/64"	5	✓
49-10BP	●	10 mm	6-9/16"	1-35/64"	5	✓
49-12BP	●	12 mm	8-1/4"	1-3/4"	5	✓
49-14BP	●	14 mm	9-1/8"	2-1/8"	5	✓

**LONG L-TYPE HEXAGONAL KEYS**

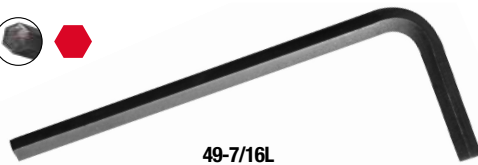

49-7/16L



49-2.5L



- Made of chrome vanadium steel.
- Chamfered tips allow quick engagement with the screw.
- Exceed ASME B18.3 and ISO 2936L standards.



**BULK**

ITEM	TIP	TIP SIZE	LENGTH (A)	HANDLE SIZE (B)	⌀	AVAILABLE
49-5/64L	●	5/64"	3-1/8"	0.61"	25	✓
49-3/32L	●	3/32"	3-3/8"	0.66"	25	✓
49-7/64L	●	7/64"	3-1/2"	0.70"	25	✓
49-1/8L	●	1/8"	3-3/4"	0.75"	25	✓
49-9/64L	●	9/64"	3-15/16"	0.80"	25	✓
49-5/32L	●	5/32"	4-1/8"	0.84"	25	✓
49-3/16L	●	3/16"	4-1/2"	0.94"	25	✓
49-7/32L	●	7/32"	4-7/8"	1.03"	10	✓
49-1/4L	●	1/4"	5-1/4"	1.12"	10	✓
49-5/16L	●	5/16"	6"	1.25"	5	✓
49-3/8L	●	3/8"	6-3/4"	1.38"	5	✓
49-7/16L	●	7/16"	7-1/2"	1.50"	5	✓

ITEM	TIP	TIP SIZE	LENGTH (A)	HANDLE SIZE (B)	⌀	AVAILABLE
49-1/2L	●	1/2"	8-1/4"	1.63"	5	✓
49-9/16L	●	9/16"	9"	1.75"	5	✓
49-5/8L	●	5/8"	9-3/4"	1.88"	5	✓
49-3/4L	●	3/4"	11-1/4"	2.13"	1	✓
49-7/8L	●	7/8"	12-3/4"	2.38"	1	✓
49-1L	●	1"	14-1/4"	2.63"	1	✓
49-3L	●	3 mm	3-7/8"	0.69"	25	✓
49-4L	●	4 mm	4"	0.75"	25	✓
49-5L	●	5 mm	4-9/16"	0.94"	25	✓
49-6L	●	6 mm	5-7/16"	1.06"	10	✓
49-8L	●	8 mm	6-1/4"	1.38"	5	✓
49-10L	●	10 mm	6-9/19"	1.54"	5	✓

## L-TYPE HEXAGONAL KEYS

### SHORT L-TYPE HEXAGONAL KEYS



INCHES  
METRIC

TORX®



URREA

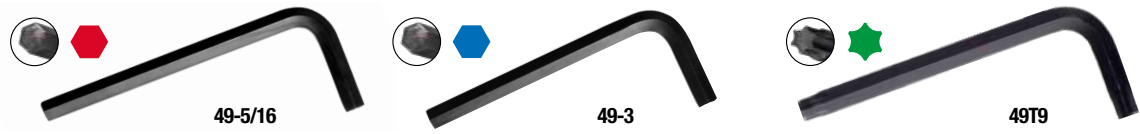

- Made of chrome vanadium steel.
- Chamfered tips allow quick engagement with the screw.
- Exceed ASME B18.3 and ISO 2936L standards.

**BULK**

ITEM	TIP	TIP SIZE	LENGTH (A)	HANDLE SIZE (B)	⌀	AVAILABLE
49-1/16	●	1/16"	1-3/4"	9/16"	25	✓
49-5/64	●	5/64"	1-7/8"	39/64"	25	✓
49-3/32	●	3/32"	2"	21/32"	25	✓
49-7/64	●	7/64"	2-1/8"	45/64"	25	✓
49-1/8	●	1/8"	2-1/4"	3/4"	25	✓
49-9/64	●	9/64"	2-3/8"	51/64"	25	✓
49-5/32	●	5/32"	2-1/2"	27/32"	25	✓
49-3/16	●	3/16"	2-3/4"	15/16"	25	✓
49-7/32	●	7/32"	3"	1"	10	✓
49-1/4	●	1/4"	3-1/4"	1-1/8"	10	✓
49-5/16	●	5/16"	3-3/4"	1-1/4"	5	✓
49-3/8	●	3/8"	4-1/4"	1-3/8"	5	✓
49-7/16	●	7/16"	4-3/4"	1-1/2"	5	✓
49-1/2	●	1/2"	5-1/4"	1-5/8"	5	✓
49-9/16	●	9/16"	5-3/4"	1-3/4"	5	✓
49-5/8	●	5/8"	6-1/4"	1-7/8"	5	✓
49-3/4	●	3/4"	7-1/4"	2-1/8"	1	✓
49-7/8	●	7/8"	8-1/4"	2-3/8"	1	✓
49-1	●	1"	9-1/4"	2-5/8"	1	✓
49-1-1/8	●	1-1/8"	10-1/4"	2-3/4"	1	✓
49-1-1/4	●	1-1/4"	11-1/4"	3"	1	✓
49-1-1/2	●	1-1/2"	13-1/4"	3-1/2"	1	✓
49-1-3/4	●	1-3/4"	15-1/4"	4"	1	✓
49-2-0	●	2"	17-1/4"	4-1/2"	1	✓
49-1.27	●	1.27 mm	1-5/8"	1/2"	25	✓
49-1.5	●	1.5 mm	1-3/4"	1/2"	25	✓
49-2	●	2 mm	1-15/16"	39/64"	25	✓
49-2.5	●	2.5 mm	2-3/16"	11/16"	25	✓
49-3	●	3 mm	2-7/16"	3/4"	25	✓
49-4	●	4 mm	2-5/8"	1"	25	✓
49-5	●	5 mm	3"	1-1/16"	25	✓
49-6	●	6 mm	3-1/2"	1-1/4"	10	✓
49-7	●	7 mm	3-5/8"	1-3/8"	5	✓
49-8	●	8 mm	3-7/8"	1-3/8"	5	✓
49-9	●	9 mm	4"	1-1/2"	5	✓
49-10	●	10 mm	4-1/4"	1-1/2"	5	✓
49-12	●	12 mm	4-13/16"	1-3/4"	5	✓
49-14	●	14 mm	5-3/8"	2-5/32"	5	✓
49-17	●	17 mm	6-1/8"	2-1/2"	1	✓
49-19	●	19 mm	6-15/16"	2-3/4"	1	✓
49-22	●	22 mm	7-11/16"	3-1/16"	1	✓
49-24	●	24 mm	8-39/64"	3-1/2"	1	✓
49-27	●	27 mm	9-39/64"	3-7/8"	1	✓
49-32	●	32 mm	12-7/64"	4-13/16"	1	✓
49-36	●	36 mm	13-41/64"	5-3/8"	1	On Request
49T7	★	T7	1-5/8"	1/2"	5	✓
49T8	★	T8	1-3/4"	9/16"	5	✓
49T9	★	T9	1-7/8"	39/64"	5	✓
49T10	★	T10	2"	21/32"	10	✓
49T15	★	T15	2-1/8"	45/64"	10	✓
49T20	★	T20	2-1/4"	3/4"	10	On Request
49T25	★	T25	2-3/8"	51/64"	10	✓
49T27	★	T27	2-1/2"	27/32"	10	✓
49T30	★	T30	2-3/4"	15/16"	10	✓
49T40	★	T40	3"	1"	10	✓
49T45	★	T45	3-1/4"	1-1/8"	5	✓
49T55	★	T55	4-1/4"	1-3/8"	5	✓

DRIVERS TOOLS

**FOLDING HEXAGONAL KEY SET**

**SAE 5/64" TO 1/4" FOLDING HEXAGONAL KEY SET** **URREA**

INDUSTRIAL DUTY INCHES

**9**  
PIECES



- Made of chrome vanadium steel.
- Metal case.
- Exceed ASME B18.3 and ISO 2936L standards.

Type	Tip size	Pieces
● Hex	5/64", 3/32", 7/64", 1/8", 9/64", 5/32", 3/16", 7/32", 1/4"	9

ITEM	PIECES	AVAILABLE
4993	9	1 ✓

**SAE 0.050" TO 3/16" FOLDING HEXAGONAL KEY SET** **URREA**

INDUSTRIAL DUTY INCHES

**9**  
PIECES



- Made of chrome vanadium steel.
- Metal case.
- Exceed ASME B18.3 and ISO 2936L standards.

Type	Tip size	Pieces
● Hex	0.050", 1/16", 5/64", 3/32", 7/64", 1/8", 9/64", 5/32", 3/16"	9

ITEM	PIECES	AVAILABLE
4978	9	1 ✓

**SAE 0.050" TO 5/32" FOLDING HEXAGONAL KEY SET** **URREA**

INDUSTRIAL DUTY INCHES

**8**  
PIECES



- Made of chrome vanadium steel.
- Metal case.
- Exceed ASME B18.3 and ISO 2936L standards.

Type	Tip size	Pieces
● Hex	0.050", 1/16", 5/64", 3/32", 7/64", 1/8", 9/64", 5/32"	8

ITEM	PIECES	AVAILABLE
4992	8	1 ✓

**SAE 3/16" TO 3/8" FOLDING HEXAGONAL KEY SET** **URREA**

INDUSTRIAL DUTY INCHES

**5**  
PIECES



- Made of chrome vanadium steel.
- Metal case.
- Exceed ASME B18.3 and ISO 2936L standards.

Type	Tip size	Pieces
● Hex	3/16", 7/32", 1/4", 5/16", 3/8"	5

ITEM	PIECES	AVAILABLE
4994	5	1 ✓

**SAE FOLDING HEXAGONAL KEY SET** **SURTEK**

PROFESSIONAL USE INCHES

**9**  
PIECES



- Metal case.
- Complies with ASME B18.3 and ISO 2936L standards.

Type	Tip size	Pieces
● Hex	5/64", 3/32", 7/64", 1/8", 9/64", 5/32", 3/16", 7/32", 1/4"	9

ITEM	PIECES	AVAILABLE
ALLFN9	9	1 On Request

**METRIC 1.5 MM TO 6 MM FOLDING HEXAGONAL KEY SET** **URREA**

INDUSTRIAL DUTY METRIC

**7**  
PIECES



- Made of chrome vanadium steel.
- Metal case.
- Exceed ASME B18.3 and ISO 2936L standards.

Type	Tip size	Pieces
● Hex	1.5 mm, 2 mm, 2.5 mm, 3 mm, 4 mm, 5 mm, 6 mm	7

ITEM	PIECES	AVAILABLE
4974	7	1 ✓

**METRIC 3 MM TO 10 MM FOLDING HEXAGONAL KEY SET** **URREA**

INDUSTRIAL DUTY METRIC

**6**  
PIECES



- Made of chrome vanadium steel.
- Metal case.
- Exceed ASME B18.3 and ISO 2936L standards.

Type	Tip size	Pieces
● Hex	3 mm, 4 mm, 5 mm, 6 mm, 8 mm, 10 mm	6

ITEM	PIECES	AVAILABLE
4973	6	1 ✓

**METRIC FOLDING HEXAGONAL KEY SET** **SURTEK**

PROFESSIONAL USE METRIC

**9**  
PIECES



- Metal case.
- Complies with ASME B18.3 and ISO 2936L standards.

Type	Tip size	Pieces
● Hex	1.3 mm, 1.5 mm, 2 mm, 2.5 mm, 3 mm, 4 mm, 5 mm, 5.5 mm, 6 mm	9

ITEM	PIECES	AVAILABLE
ALLFN9M	9	1 On Request

**TORX T10 TO T40 FOLDING HEXAGONAL KEY SET** **URREA**

INDUSTRIAL DUTY TORX®

**7**  
PIECES



- Made of chrome vanadium steel.
- Metal case.
- Exceed ASME B18.3 and ISO 2936L standards.

Type	Tip size	Pieces
★ Torx®	T10, T15, T20, T25, T27, T30, T40	7

ITEM	PIECES	AVAILABLE
4979TX	7	1 ✓

**TORX FOLDING TORX KEY SETS** **SURTEK**

PROFESSIONAL USE TORX®

**8**  
PIECES



- Metal case.
- Complies with ASME B18.3 and ISO 2936L standards.

Type	Tip size	Pieces
★ Torx®	T9, T10, T15, T20, T25, T27, T30, T40	8

ITEM	PIECES	AVAILABLE
X	8	1 On Request

**TORX FOLDING TORX KEY SETS** **SURTEK**

PROFESSIONAL USE TORX®

**7**  
PIECES



- Metal case.
- Complies with ASME B18.3 and ISO 2936L standards.

Type	Tip size	Pieces
★ Torx®	T9, T10, T15, T20, T25, T30, T40	7

ITEM	PIECES	AVAILABLE
ALLTNA7	7	1 On Request

## FOLDING HEXAGONAL KEY SETS

### COLOR CODING



### BIMATERIAL FOLDING CASE

# FOLDING HEX KEY SETS.

### TYPE TIPS

- HEX BIT** Chamfered tips for faster insertion and full tool engagement in the screw head.
- TORX® BIT** Special design for Torx fasteners, widely used in the automotive industry.

#### COMBINATION FOLDING HEXAGONAL KEY SET



Type	Tip size	Pieces
Hex	5/64", 3/32", 7/64", 1/8", 9/64", 5/32", 3/16", 7/32", 1/4"	8
Hex	1.5 mm, 2 mm, 2.5 mm, 3 mm, 4 mm, 5 mm, 6 mm	7
Torx®	T8, T10, T15, T20, T25, T27, T30, T40	8

ITEM	PIECES	AVAILABLE
49824	24	1 ✓

#### COMBINATION FOLDING HEXAGONAL KEY SET



Type	Tip size	Pieces
Hex	5/64", 3/32", 7/64", 1/8", 9/64", 5/32", 3/16", 7/32", 1/4"	9
Hex	1.5 mm, 2 mm, 2.5 mm, 3 mm, 4 mm, 5 mm, 6 mm	7

ITEM	PIECES	AVAILABLE
49816	16	1 ✓

#### SAE FOLDING HEXAGONAL KEY SET



Type	Tip size	Pieces
Hex	5/64", 3/32", 7/64", 1/8", 9/64", 5/32", 3/16", 7/32", 1/4"	9

ITEM	PIECES	AVAILABLE
4977B	9	1 ✓

#### SAE FOLDING HEXAGONAL KEY SET



Type	Tip size	Pieces
Hex	0.050", 1/16", 5/64", 3/32", 7/64", 1/8", 9/64", 5/32", 3/16"	9

ITEM	PIECES	AVAILABLE
4978B	9	1 ✓

#### SAE FOLDING HEXAGONAL KEY SET



Type	Tip size	Pieces
Hex	5/32", 3/16", 7/32", 1/4", 5/16", 3/8"	6

ITEM	PIECES	AVAILABLE
4994B	6	1 ✓

#### SAE FOLDING HEXAGONAL KEY SET



Type	Tip size	Pieces
Hex	5/64", 3/32", 7/64", 1/8", 5/32", 3/16", 7/32", 1/4"	8

ITEM	PIECES	AVAILABLE
ALLFNX8	8	1 On Request

FOLDING HEXAGONAL KEY SET

METRIC FOLDING HEXAGONAL KEY SET



METRIC



7  
PIECES



- Made of chrome vanadium steel.
- Bi-material plastic case.
- Exceed ASME B18.3 and ISO 2936L standards.

Type	Tip size	Pieces
Hex	2 mm, 2.5 mm, 3 mm, 4 mm, 5 mm, 6 mm, 8 mm	7

ITEM	PIECES	AVAILABLE
4977BM	7	1 ✓

METRIC FOLDING HEXAGONAL KEY SET



METRIC



6  
PIECES



- Made of chrome vanadium steel.
- Bi-material plastic case.
- Exceed ASME B18.3 and ISO 2936L standards.

Type	Tip size	Pieces
Hex	3 mm, 4 mm, 5 mm, 6 mm, 8 mm, 10 mm	6

ITEM	PIECES	AVAILABLE
4973BM	6	1 ✓

METRIC FOLDING HEXAGONAL KEY SET



METRIC



8  
PIECES



- Bi-material plastic case.
- Complies with ASME B18.3 and ISO 2936L standards.

Type	Tip size	Pieces
Hex	1.5 mm, 2 mm, 2.5 mm, 3 mm, 4 mm, 5 mm, 6 mm, 8 mm	8

ITEM	PIECES	AVAILABLE
ALLFNX8M	8	1 On Request

TORX FOLDING TORX KEY SET



TORX®



8  
PIECES



- Made of chrome vanadium steel.
- Bi-material plastic case.
- Exceed ASME B18.3 and ISO 2936L standards.

Type	Tip size	Pieces
Torx®	T6, T7, T8, T9, T10, T15, T20, T25	8

ITEM	PIECES	AVAILABLE
4976TX	8	1 ✓

TORX FOLDING TORX KEY SET



TORX®



7  
PIECES



- Made of chrome vanadium steel.
- Bi-material plastic case.
- Exceed ASME B18.3 and ISO 2936L standards.

Type	Tip size	Pieces
Torx®	T10, T15, T20, T25, T27, T30, T40	7

ITEM	PIECES	AVAILABLE
4977TX	7	1 ✓

TORX FOLDING TORX KEY SET



TORX®



8  
PIECES



- Bi-material plastic case.
- Complies with ASME B18.3 and ISO 2936L standards.

Type	Tip size	Pieces
Torx®	T9, T10, T15, T20, T25, T27, T30, T40	8

ITEM	PIECES	AVAILABLE
ALLFTNX8	8	1 On Request

TORX FOLDING TORX KEY SET



TORX®



7  
PIECES



- Made of chrome vanadium steel.
- Bi-material plastic case.
- Exceed ASME B18.3 and ISO 2936L standards.

Type	Tip size	Pieces
Torx®	T10, T15, T20, T25, T27, T30, T40	7

ITEM	PIECES	AVAILABLE
4977TXT	7	1 ✓

## FOLDING HEXAGONAL KEY SETS

### SAE FOLDING HEXAGONAL KEY SETS

PROFESSIONAL USE INCHES

10 PIECES



- Plastic case.
- Complies with ASME B18.3 and ISO 2936L standards.

Type	Dimensions	Pieces
Hex	1/16", 5/64", 3/32", 7/64", 1/8", 9/64", 5/32", 3/16", 7/32", 1/4"	10

ITEM	PIECES	AVAILABLE
ALLFNP10	10	On Request

### METRIC FOLDING HEXAGONAL KEY SET

PROFESSIONAL USE METRIC

10 PIECES



- Plastic case.
- Complies with ASME B18.3 and ISO 2936L standards.

Type	Dimensions	Pieces
Hex	1.3 mm, 1.5 mm, 2 mm, 2.5 mm, 3 mm, 3.5 mm, 4 mm, 5 mm, 5.5 mm, 6 mm	10

ITEM	PIECES	AVAILABLE
ALLFNP10M	10	On Request

### TORX FOLDING TORX KEY SET

PROFESSIONAL USE TORX

8 PIECES



- Plastic case.
- Complies with ASME B18.3 and ISO 2936L standards.

Type	Dimensions	Pieces
Torx	T9, T10, T15, T20, T25, T27, T30, T40	8

ITEM	PIECES	AVAILABLE
ALLFTNP8	8	On Request

## HEAVY-DUTY BIT SETS

### POWER BIT AND SCREWDRIVER BIT SET WITH ACCESSORIES

HEAVY DUTY 1/4" TORX S2 ALLOY BIT MATERIAL

19 PIECES

- 1/4" and 3/8" socket adapters with locking pin.
- 1/4" square quick-release adapter.

- Bits ideal for continuous-use applications, production lines, and assembly processes.
- Designed for use with electric or pneumatic power tools.

Content-Adapter-		Content-Tips-		
Adapter	Size	Tip	Length	Tip Size
For Tip	1/4", drive 1/4"	Phillips	1"	PH1, PH2, PH3
For bits w/quick release	1/4", drive 1/4" H	Slotted	1"	5F-6R, 6F-8R, 8F-10R
For socket	1/4" x 1/4" x 1"	Phillips	1-15/16"	PH1, PH2, PH3
For socket	1/4" x 1/4" x 2"	Phillips	1-15/16"	PH1, PH2, PH3
For socket	1/4" H x 3/8" x 2"	Torx	1 15/16"	T15, T20, T25
For socket	1/4" H x 3/8" x 6"			
For socket	1/4" x 3/8" x 2"			



ITEM	PIECES	AVAILABLE
61919	19	On Request

### POWER BIT SET QUICK RELEASE WITH ACCESSORIES

HEAVY DUTY 1/4" TORX S2 ALLOY BIT MATERIAL

19 PIECES

- 1/4" square quick-release adapter

- Bits ideal for continuous-use applications, production lines, and assembly processes.
- Designed for use with electric or pneumatic power tools.

Content		
Tip	Length	Tip Size
Slotted	3"	4F-5R, 5F-6R
Slotted	6"	4F-5F, 5F-6R
Phillips	2-3/4"	PH1, PH2, PH3
Phillips	6"	PH1, PH2, PH3
Torx	2-3/4"	T15, T20, T25, T27
Torx	6"	T15, T20, T25, T27
Adapter for 1/4" bits 1/4" square		



ITEM	PIECES	AVAILABLE
61919X	19	✓



HEAVY-DUTY BIT SETS



SHOCK REDUCTION SYSTEM  
SCREWDRIVER BITS



Ideal for use with impact tools, absorbing high torque peaks.

Made of S2 steel for increased durability and strength.

Precision-machined tips for a perfect fit, preventing slippage.

High-strength torsion zone that absorbs impact and prevents breakage.

Prevents screw wear, even under high torque.



DRIVERS TOOLS

SHOCK REDUCTION SYSTEM SCREWDRIVER BIT SET



54  
PIECES

- Bits made of S2 steel.
- Shock reduction system reduces high torque peaks generated by power tools, extending bit life.
- Greater durability and strength compared to traditional bits.
- Perfect fit in screws, preventing slippage.

Tip	Description	Length	Pieces
⊖ Slotted	SL6 x 2, SL8 x 2	25 mm	4
	SL8	50 mm	1
⊕ Phillips®	PH1 x 2, PH2 x 6, PH3 x 2	25 mm	10
	PH2 x 2, PH3	50 mm	3
★ Torx®	T10 x 2, T15 x 2, T20 x 4, T25 x 5, T27 x 2, T30 x 2, T40	25 mm	18
	T20, T25 x 2	50 mm	3
■ Square	S1 x 2, S2 x 4, S3 x 2	25 mm	8
	S2 x 2, S3	50 mm	3
Nut drive	1/4", 5/16" y 3/8"		3
Accessories	Magnetic tip holder		



ITEM	PIECES	⊞	AVAILABLE
JUP54	54	1	On Request

SHOCK REDUCTION SYSTEM SCREWDRIVER BIT SET



48  
PIECES

- Bits made of S2 steel.
- Shock reduction system reduces high torque peaks generated by power tools, extending bit life.
- Greater durability and strength compared to traditional bits.
- Perfect fit in screws, preventing slippage.

Tip	Description	Length	Pieces
⊖ Slotted	SL6 x 2, SL8 x 2	25 mm	4
	SL8	50 mm	1
⊕ Phillips®	PH1 x 2, PH2 x 6, PH3 x 2	25 mm	10
	PH2 x 2, PH3	50 mm	3
★ Torx®	T10, T15, T20 x 4, T25 x 4, T27, T30, T40	25 mm	13
	T20, T25	50 mm	2
■ Square	S1, S2 x 3, S3	25 mm	5
	S2	50 mm	1
Drill bits	1/16", 3/32", 7/64", 1/8", 9/64", 5/32", 3/16" y 1/4"		8
Accessories	Magnetic tip holder		1



ITEM	PIECES	⊞	AVAILABLE
JUP48	48	1	On Request

## HEAVY-DUTY BIT SETS

### SHOCK REDUCTION SYSTEM SCREWDRIVER BIT SET



**42**  
PIECES

- Bits made of S2 steel.
- Shock reduction system reduces high torque peaks generated by power tools, extending bit life.
- Greater durability and strength compared to traditional bits.
- Perfect fit in screws, preventing slippage.

Tip	Description	Length	Pieces
Slotted	SL6, SL8	25 mm	2
	SL8	50 mm	1
Phillips®	PH1, PH2 x 5, PH3 x 2	25 mm	8
	PH1, PH2 x 2, PH3	50 mm	4
	T10, T15, T20 x 2, T25 x 3, T27, T30, T40	25 mm	10
Torx®	T20, T25 x 2	50 mm	3
	S1, S2 x 2, S3	25 mm	4
Square	S2 x 2	50 mm	2
	Nut drive	1/4", 5/16" y 3/8"	3
Socket adapter	3/8"		1
Drill bits	3 mm, 4 mm, 5 mm		3
Accessories	Magnetic tip holder		1



ITEM	PIECES	AVAILABLE
JUP42	42	On Request

### SHOCK REDUCTION SYSTEM SCREWDRIVER BIT SET



**42**  
PIECES

- Bits made of S2 steel.
- Shock reduction system reduces high torque peaks generated by power tools, extending bit life.
- Greater durability and strength compared to traditional bits.
- Perfect fit in screws, preventing slippage.

Tip	Description	Length	Pieces
Slotted	SL8	25 mm	1
Phillips®	PH1, PH2 x 8, PH3 x 3	25 mm	12
	PH2 x 2, PH3	50 mm	3
Torx®	T10, T15, T20 x 2, T25 x 4, T27, T30, T40	25 mm	11
	T20 x 2, T25	50 mm	3
Square	S1 x 2, S2 x 4, S3 x 2	25 mm	8
	S2 x 2	50 mm	2
Socket adapter	3/8"		1
Accessories	Magnetic tip holder		1



ITEM	PIECES	AVAILABLE
JUP42A	42	On Request

### SHOCK REDUCTION SYSTEM SCREWDRIVER BIT SET



**34**  
PIECES

- Bits made of S2 steel.
- Shock reduction system reduces high torque peaks generated by power tools, extending bit life.
- Greater durability and strength compared to traditional bits.
- Perfect fit in screws, preventing slippage.

Tip	Description	Length	Pieces
Slotted	SL8	25 mm	1
Phillips®	PH1, PH2 x 6, PH3 x 2	25 mm	9
	PH2, PH3	50 mm	2
Torx®	T15, T20 x 3, T25 x 3, T30	25 mm	8
	T20, T25	50 mm	2
Square	S1, S2 x 3, S3 x 2	25 mm	6
	S2	50 mm	1
Socket adapter	3/8"		1
Nut drive	1/4" y 5/16"		2
Accessories	Bit holder and extension for magnetic bits		2



ITEM	PIECES	AVAILABLE
JUP34	34	On Request

**HEAVY-DUTY BIT SETS**

**SHOCK REDUCTION SYSTEM SCREWDRIVER BIT SET**



**18**  
PIECES

- Bits made of S2 steel.
- Shock reduction system reduces high torque peaks generated by power tools, extending bit life.
- Greater durability and strength compared to traditional bits.
- Perfect fit in screws, preventing slippage.

Tip	Description	Length	Pieces
+ Phillips®	PH2 x 2, PH3	25 mm	3
	PH2, PH3	50 mm	2
★ Torx®	T20, T25	25 mm	2
	T25	50 mm	1
■ Square	S2 x 2, S3	25 mm	3
	S2	50 mm	1
Drill bits	3/32", 1/8", 5/32", 3/16" y 1/4"		5
Accessories	Magnetic tip holder		1



ITEM	PIECES	⊞	AVAILABLE
JUP18	18	1	✓

**1/4" HEX BIT SETS WITH POWER MAGNETIC ADAPTER**



**56**  
PIECES

- Made of S2 steel.
- Power bits in 25 mm and 75 mm lengths.
- Includes quick-release power magnetic bit holder.
- Supplied in a 12-piece color display box.
- Exceeds ASME B107.600 standard.

Tip	Description	Length	Pieces
+ Phillips®	PH1 x 3, PH x 3, PH x 3	25 mm	11
	PH2, PH3	75 mm	
+ Pozidrive®	PZ1 x 3, PZ2 x 3, PZ3 x 3	25 mm	11
	PZ1, PZ2	75 mm	
- Slotted	SL4 x 2, SL5 x 2, SL6 x 2	25 mm	7
	SL6	75 mm	
● Hex	3 mm, 4 mm, 5 mm	25 mm	3
★ Torx®	T10 x 2, T15 x 2, T20 x 2, T25 x 2, T27 x 2, T30 x 2, T40 x 2	25 mm	16
	T20, T25	75 mm	
★ Security Torx® bit	T10, T15, T20, T25, T27, T30, T40	25 mm	7
○ 1/4" Magnetic bit holder			1



ITEM	PIECES	⊞	AVAILABLE
61956	56	1	On Request



**42**  
PIECES

- Made of S2 steel.
- Exceeds ASME B107.600 standard.

Tip	Description	Length	Pieces
★ Torx®	T10, T15, T20, T25, T27, T30, T35, T40	25 mm	8
● Hex	2 mm, 2.5 mm, 3 mm, 4 mm, 5 mm, 6 mm, 8 mm	25 mm	7
+ Phillips®	PH0, PH1, PH2, PH3	25 mm	4
- Slotted	3 mm, 4 mm, 5 mm, 6 mm, 7 mm, 8 mm	25 mm	6
+ Pozidrive®	PZ0, PZ1, PZ2, PZ3	25 mm	4
● Nut drive	3/16", 9/32", 11/32", 3/8", 5/16", 1/4"	38 mm	6
● Power bit	3/16", 1/4"	50 mm	2
+ Phillips® power bit	PH1, PH2	50 mm	2
● Bit adapter	1/4"	2-3/8"	1
● Socket adapter	1/4" x 1"	1"	1
● 1/4" x 2" power socket adapter		2"	1



ITEM	PIECES	⊞	AVAILABLE
60142	42	1	✓

## HEAVY-DUTY BIT SETS

### 1/4" HEX BIT SETS WITH POWER MAGNETIC ADAPTER



**37**  
PIECES

- Made of S2 steel.
- Exceeds ASME B107.600 standard.

Tip	Description	Length	Pieces
Slotted	3-4, 6-8, 8-10, 10-12	25 mm	4
Phillips®	PH1, PH2, PH3	25 mm	3
Phillips® reducida	PH2 x 5	25 mm	5
Hex	5/64", 3/32", 7/64", 1/8", 9/64", 5/32", 3/16"	25 mm	7
Torx®	T8, T9, T10, T15, T20, T25, T27, T30, T40	25 mm	9
Cuadrada	RB0, RB1, RB2, RB3	25 mm	4
Clutch	1/8", 5/32", 3/16", 1/4"	25 mm	4
1/4" Magnetic bit holder		3"	1



ITEM	PIECES	AVAILABLE
61927	37	1 ✓



**32**  
PIECES

- Made of S2 steel.
- Power bits in 25 mm and 75 mm lengths.
- Includes quick-release power magnetic bit holder.
- Supplied in a 12-piece color display box.
- Exceeds ASME B107.600 standard.

Tip	Description	Length	Pieces
Phillips®	PH1, PH3, PH2 x 2	25 mm	4
Pozidrive®	PZ1, PZ3, PZ2 x 2	25 mm	4
Slotted	SL0.5 x 3.0, SL0.8 x 4.0, SL0.8 x 5.0, SL1.2 x 6.5 mm	25 mm	4
Hex	H3, H4, H5, H6 mm	25 mm	4
Torx®	T10, T15, T20, T25, T27, T30, T40	25 mm	7
Torx® de seguridad	T10H, T15H, T20H, T25H, T27H, T30H, T40H	25 mm	7
1/4" Magnetic tip holder			1
1/4" Female magnetic bit holder			1



ITEM	PIECES	AVAILABLE
61932	32	1 On Request

### 1/4" HEX DRIVE COMBINATION BIT SET



**9**  
PIECES



- Made of chrome vanadium steel.
- Complies with ASME B107.600 standard.

Tip	Description	Pieces
Phillips®	PH1, PH2, PH3	3
Slotted	3/16", 1/4", 5/16"	3
Pozidrive	PZ2	1
Drive	S1, S2	2



ITEM	PIECES	AVAILABLE
PFC9	9	6 On Request



**5**  
PIECES



- Made of chrome vanadium steel.
- Complies with ASME B107.600 standard.

Tip	Description	Length	Pieces
Phillips®	PH0, PH1, PH2	2"	3
Slotted	3/16", 1/4"	2"	2



ITEM	PIECES	AVAILABLE
PF525	5	12 On Request

### 1/4" HEX DRIVE COMBINATION EXTRA LONG BIT SET



**9**  
PIECES



- Made of chrome vanadium steel.
- Complies with ASME B107.600 standard.

Tip	Description	Length	Pieces
Phillips®	PH1, PH2, PH3	150 mm	3
Slotted	3 mm, 5 mm, 7 mm	150 mm	3
Pozidrive	PZ1, PZ2, PZ3	150 mm	3



ITEM	PIECES	AVAILABLE
PFCL9	9	1 On Request

**POWER DRIVE NUT SETTERS**

**1/4" HEX POWER DRIVE METRIC NUT SETTER WITH RETRACTABLE MAGNET**

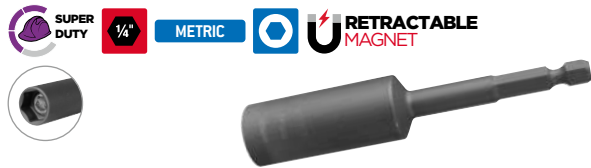

10214

- Made of chrome vanadium steel.
- Retractable magnet holds the nut or screw securely inside the socket cavity.
- 1/4" hex shank.
- Exceeds ISO 1173 standard.

**BULK**

ITEM	TYPE TIP	OPENING SIZE	TOTAL LENGTH (A)	BOX DEPTH (B)	SHANK	AVAILABLE
11114	○	14 mm	70 mm	20 mm	1/4"	✓
10208	○	8 mm	100 mm	25 mm	1/4"	✓
10210	○	10 mm	100 mm	25 mm	1/4"	✓
10212	○	12 mm	100 mm	25 mm	1/4"	✓
10213	○	13 mm	100 mm	25 mm	1/4"	✓
10214	○	14 mm	100 mm	25 mm	1/4"	✓
10216	○	16 mm	100 mm	25 mm	1/4"	✓
10410	○	10 mm	150 mm	26 mm	1/4"	✓
10412	○	12 mm	150 mm	26 mm	1/4"	✓
10413	○	13 mm	150 mm	26 mm	1/4"	✓
10414	○	14 mm	150 mm	26 mm	1/4"	✓
11610	○	10 mm	200 mm	26 mm	1/4"	✓
11612	○	12 mm	200 mm	26 mm	1/4"	✓

**1/4" HEX POWER DRIVE SAE MAGNETIC NUT SETTER**



10560

10108

- Made of chrome vanadium steel.
- 1/4" hex shank.
- Exceeds ISO 1173 standard.

ITEM	TYPE TIP	OPENING SIZE	OUTER DIAMETER	TOTAL LENGTH (A)	SHANK	PIECES PER BOX	AVAILABLE
10560	○	1/4"	7/16"	1-7/8"	1/4"	6	✓
10576	○	5/16"	1/2"	1-7/8"	1/4"	6	✓
10584	○	3/8"	9/16"	1-7/8"	1/4"	6	✓
10592	○	7/16"	5/8"	1-7/8"	1/4"	6	✓
10504	○	1/4"	7/16"	2-9/16"	1/4"	6	✓
10520	○	5/16"	1/2"	2-9/16"	1/4"	6	✓
10536	○	3/8"	9/16"	2-9/16"	1/4"	6	✓
10552	○	7/16"	5/8"	2-9/16"	1/4"	6	✓
10108	○	8 mm	1/2"	1-7/8"	1/4"	6	✓
10116	○	10 mm	9/16"	1-7/8"	1/4"	6	✓

**1/4" HEX POWER DRIVE METRIC MAGNETIC NUT SETTER**



PCJ5

- Made of chrome vanadium steel.
- Complies with ISO 1173 standard.

ITEM	TYPE TIP	OPENING SIZE	OUTER DIAMETER	TOTAL LENGTH (A)	SHANK	PIECES PER BOX	AVAILABLE
PCJ5	○	5 mm	8.4 mm	2"	1/4"	5	On Request
PCJ6	○	6 mm	10.9 mm	2"	1/4"	5	On Request
PCJ8	○	8 mm	12.9 mm	2"	1/4"	5	On Request
PCJ10	○	10 mm	14.4 mm	2"	1/4"	5	On Request
PCJ12	○	12 mm	16 mm	2"	1/4"	5	On Request

**1/4" HEXAGONAL DRIVE SAE MAGNETIC NUT SETTER**

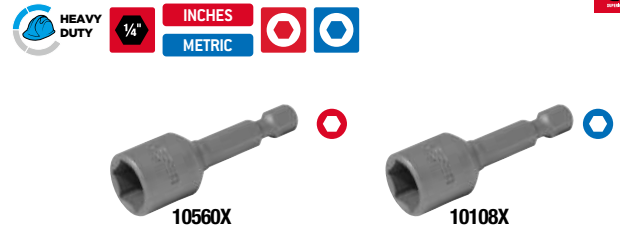

10560X

10108X

- Made of chrome vanadium steel.
- 1/4" hex shank.
- Exceeds ISO 1173 standard.

ITEM	TYPE TIP	OPENING SIZE	OUTER DIAMETER	TOTAL LENGTH (A)	SHANK	PIECES PER BOX	AVAILABLE
10560X	○	1/4"	7/16"	1-3/4"	1/4"	5	✓
10576X	○	5/16"	1/2"	1-3/4"	1/4"	5	✓
10584X	○	3/8"	9/16"	1-3/4"	1/4"	5	✓
10592X	○	7/16"	5/8"	1-3/4"	1/4"	5	✓
10504X	○	1/4"	7/16"	2-9/16"	1/4"	5	✓
10520X	○	5/16"	1/2"	2-9/16"	1/4"	5	✓
10536X	○	3/8"	9/16"	2-9/16"	1/4"	5	✓
10552X	○	7/16"	5/8"	2-9/16"	1/4"	5	✓
10108X	○	8 mm	1/2"	1-3/4"	1/4"	5	✓
10116X	○	10 mm	9/16"	1-3/4"	1/4"	5	✓

**1/4" HEX POWER DRIVE SAE MAGNETIC NUT SETTER**



PCJ316

- Made of chrome vanadium steel.
- Complies with ISO 1173 standard.

ITEM	TYPE TIP	OPENING SIZE	OUTER DIAMETER	TOTAL LENGTH (A)	SHANK	PIECES PER BOX	AVAILABLE
PCJ316	○	3/16"	8.4 mm	2"	1/4"	5	On Request
PCJ14	○	1/4"	10.9 mm	2"	1/4"	5	On Request
PCA516	○	5/16"	12.9 mm	2"	1/4"	5	On Request
PCA38	○	3/8"	14.4 mm	2"	1/4"	5	On Request
PCA716	○	7/16"	16 mm	2"	1/4"	5	On Request

**1/4" HEX POWER DRIVE SAE MAGNETIC NUT SETTER**



- Made of chrome vanadium steel.
- Complies with ISO 1173 standard.

ITEM	TYPE TIP	OPENING SIZE	OUTER DIAMETER	TOTAL LENGTH (A)	SHANK	PIECES PER POLYBAG	AVAILABLE
PCJ1/4	○	1/4"	10.9 mm	65 mm	1/4"	5	On Request
PCJ5/16	○	5/16"	12.9 mm	65 mm	1/4"	10	On Request
PCJ3/8	○	3/8"	14.4 mm	65 mm	1/4"	10	On Request

## POWER DRIVE SLOTTED BITS

### 1/4" HEX POWER DRIVE SLOTTED BITS

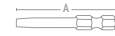

- Made of S2 steel for continuous use in production lines and assembly processes.
- Designed to work with electric or pneumatic power tools, handling high applied torque.
- Exceeds ASME B107.600 and ISO 1173 standards.

ITEM	TYPE TIP	TIP THICKNESS	TIP WIDTH	TOTAL LENGTH (A)	SHANK	PIECES PER POLYBAG	☞	AVAILABLE
14008X	⊖	0.036"	1/4"	1-15/16"	⊖	5	5	✓
14012X	⊖	0.038"	1/4"	1-15/16"	⊖	5	5	✓
14016X	⊖	0.042"	9/32"	1-15/16"	⊖	5	5	✓
14020X	⊖	0.046"	5/16"	1-15/16"	⊖	5	5	✓



14008X



### 1/4" HEX POWER DRIVE SLOTTED BITS



- Made of S2 steel for continuous use in production lines and assembly processes.
- Exceeds ASME B107.600 and ISO 1173 standards.

ITEM	TYPE TIP	TIP THICKNESS	TIP WIDTH	TOTAL LENGTH (A)	SHANK	PIECES PER BOX	☞	AVAILABLE
14012	⊖	0.038"	1/4"	1-15/16"	⊖	10	10	✓
14016	⊖	0.042"	9/32"	1-15/16"	⊖	10	10	✓
14020	⊖	0.046"	5/16"	1-15/16"	⊖	10	10	✓
14024	⊖	0.050"	3/8"	1-15/16"	⊖	10	10	✓



14012



### 1/4" HEX POWER DRIVE SLOTTED BITS



- Made of S2 steel.
- Complies with ASME B107.600 and ISO 1173 standards.

ITEM	TYPE TIP	TIP THICKNESS	TIP WIDTH	TOTAL LENGTH (A)	SHANK	PIECES PER BOX	☞	AVAILABLE
PPL142	⊖	0.038"	1/4"	2"	⊖	5	1	On Request
PPL9322	⊖	0.042"	9/32"	2"	⊖	5	1	On Request
PPL5162	⊖	0.046"	5/16"	2"	⊖	5	1	On Request
PPL382	⊖	0.052"	3/8"	2"	⊖	5	1	On Request



PPL142



NEW

### 1/4" HEX POWER DRIVE FLAT BITS

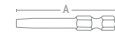

- Made of S2 steel.
- Complies with ASME B107.600 and ISO 1173 standards.

ITEM	TYPE TIP	TIP THICKNESS	TIP WIDTH	TOTAL LENGTH (A)	SHANK	PIECES PER BLISTER	☞	AVAILABLE
PF523	⊖	0.028"	3/16"	2"	⊖	5	12	On Request
PF524	⊖	0.032"	1/4"	2"	⊖	5	12	On Request



PF524



### 1/4" HEX POWER DRIVE SLOTTED BITS

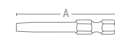

- Made of S2 steel.
- Complies with ASME B107.600 and ISO 1173 standards.

ITEM	TYPE TIP	TIP THICKNESS	TIP WIDTH	TOTAL LENGTH (A)	SHANK	PIECES PER POLYBAG	☞	AVAILABLE
PPL101	⊖	0.038"	1/4"	2"	⊖	5	1	On Request
PPL62	⊖	0.042"	9/32"	2"	⊖	5	1	On Request
PPL82	⊖	0.046"	5/16"	2"	⊖	5	1	On Request
PPL102	⊖	0.052"	3/8"	2"	⊖	5	1	On Request



PPL62



NEW

**POWER DRIVE PHILLIPS BITS**

**1/4" HEX POWER DRIVE PHILLIPS BITS**



**URREA**  
Tools for Professionals



- Made of S2 steel for continuous use in production lines and assembly processes.
- Designed to work with electric or pneumatic power tools, handling high applied torque.
- Exceeds ASME B107.600 and ISO 1173 standards.

ITEM	TYPE TIP	TIP SIZE	TIP DIAMETER	TOTAL LENGTH (A)	SHANK	PIECES PER POLYBAG	⊞	AVAILABLE
12000X	+	PH 1	3/16"	1-15/16"	1/4"	5	5	✓
12004X	+	PH 2	1/4"	1-15/16"	1/4"	5	5	✓
12008X	+	PH 3	1/4"	1-15/16"	1/4"	5	5	✓
12016X	+	PH 1	3/16"	2-3/4"	1/4"	5	5	✓
12020X	+	PH 2	1/4"	2-3/4"	1/4"	5	5	✓
12031X	+	PH 1	3/16"	3-1/2"	1/4"	5	5	✓
12032X	+	PH 2	1/4"	3-1/2"	1/4"	5	5	✓
12033X	+	PH 3	1/4"	3-1/2"	1/4"	5	5	✓
12061X	+	PH 1	3/16"	6"	1/4"	5	5	✓
12062X	+	PH 2	1/4"	6"	1/4"	5	5	✓
12063X	+	PH 3	1/4"	6"	1/4"	5	5	✓



DRIVERS TOOLS

**1/4" HEX POWER DRIVE PHILLIPS BITS**



**URREA**  
Tools for Professionals

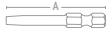

- Made of S2 steel for continuous use in production lines and assembly processes.
- Exceeds ASME B107.600 and ISO 1173 standards.

ITEM	TYPE TIP	TIP SIZE	TIP DIAMETER	TOTAL LENGTH (A)	SHANK	PIECES PER BOX	⊞	AVAILABLE
12000	+	PH 1	3/16"	1-15/16"	1/4"	10	10	✓
12004	+	PH 2	1/4"	1-15/16"	1/4"	10	10	✓
12008	+	PH 3	1/4"	1-15/16"	1/4"	10	10	✓
12016	+	PH 1	3/16"	2-3/4"	1/4"	10	10	✓
12020	+	PH 2	1/4"	2-3/4"	1/4"	10	10	✓
12024	+	PH 3	1/4"	2-3/4"	1/4"	10	10	✓
12032	+	PH 2	1/4"	3-1/2"	1/4"	10	10	✓
12062	+	PH 2	1/4"	6"	1/4"	10	10	✓



**1/4" HEX DRIVE PHILLIPS SCREWDRIVER BITS**



**SURTEK**  
TOOLS FOR PROFESSIONALS



- Made of S2 steel.
- Complies with ASME B107.600 and ISO 1173 standards.

ITEM	TYPE TIP	TIP SIZE	TOTAL LENGTH (A)	SHANK	PIECES PER BOX	⊞	AVAILABLE
PPH01A	+	PH0	1"	1/4"	5	1	On Request
PPH11A	+	PH1	1"	1/4"	5	1	On Request
PPH21A	+	PH2	1"	1/4"	5	1	On Request
PPH31A	+	PH3	1"	1/4"	5	1	On Request
PPH11C	+	PH1	1"	1/4"	15	1	On Request
PPH21C	+	PH2	1"	1/4"	15	1	On Request
PPH02	+	PH0	2"	1/4"	5	1	On Request
PPH12A	+	PH1	2"	1/4"	5	1	On Request
PPH12C	+	PH2	2"	1/4"	5	1	On Request
PPH22A	+	PH3	2"	1/4"	5	1	On Request
PPH22C	+	PH1	2"	1/4"	15	1	On Request
PPH32A	+	PH2	2"	1/4"	15	1	On Request
PPH32B	+	PH3	2"	1/4"	15	1	On Request
PPH03	+	PH0	3"	1/4"	5	1	On Request
PPH13	+	PH1	3"	1/4"	5	1	On Request
PPH23	+	PH2	3"	1/4"	5	1	On Request
PPH33	+	PH3	3"	1/4"	5	1	On Request
PPH14	+	PH1	4"	1/4"	5	1	On Request
PPH24	+	PH2	4"	1/4"	5	1	On Request



NEW

## POWER DRIVE PHILLIPS BITS

### 1/4" HEX POWER DRIVE PHILLIPS BITS



- Made of S2 steel.
- Complies with ASME B107.600 and ISO 1173 standards.



PF521

ITEM	TYPE TIP	TIP SIZE	TOTAL LENGTH (A)	SHANK	PIECES PER BLISTER	☞	AVAILABLE
PF520	+	PH0	2"	1/4"	5	12	On Request
PF521	+	PH1	2"	1/4"	5	12	On Request
PF522	+	PH2	2"	1/4"	5	12	On Request



### 1/4" HEX POWER DRIVE PHILLIPS BITS



- Made of S2 steel.
- Complies with ASME B107.600 and ISO 1173 standards.



PPH22

ITEM	TYPE TIP	TIP SIZE	TOTAL LENGTH (A)	SHANK	PIECES PER POLYBAG	☞	AVAILABLE
PPH12	+	PH1	2"	1/4"	5	1	On Request
PPH22	+	PH2	2"	1/4"	20	1	On Request
PPH32	+	PH3	2"	1/4"	5	1	On Request



## POWER DRIVE TORX BITS

### 1/4" HEX POWER DRIVE TORX BITS

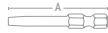

- Made of S2 steel for continuous use in production lines and assembly processes.
- Designed to work with electric or pneumatic power tools, handling high applied torque.
- Exceeds ASME B107.600 and ISO 1173 standards.

ITEM	TYPE TIP	TYPE SIZE	TIP DIAMETER	TOTAL LENGTH (A)	SHANK	PIECES PER BOX	☞	AVAILABLE
16040X	★	T6	1/8"	1-15/16"	1/4"	5	5	✓
16000X	★	T7	1/8"	1-15/16"	1/4"	5	5	✓
16004X	★	T8	1/8"	1-15/16"	1/4"	5	5	✓
16008X	★	T9	1/8"	1-15/16"	1/4"	5	5	✓
16012X	★	T10	5/32"	1-15/16"	1/4"	5	5	✓
16016X	★	T15	5/32"	1-15/16"	1/4"	5	5	✓
16020X	★	T20	3/16"	1-15/16"	1/4"	5	5	✓
16028X	★	T27	1/4"	1-15/16"	1/4"	5	5	✓
16032X	★	T30	1/4"	1-15/16"	1/4"	5	5	✓
16036X	★	T40	5/16"	1-15/16"	1/4"	5	5	✓
16308X	★	T8	1/8"	3-1/2"	1/4"	5	5	✓
16310X	★	T10	5/32"	3-1/2"	1/4"	5	5	✓
16315X	★	T15	5/32"	3-1/2"	1/4"	5	5	✓
16320X	★	T20	3/16"	3-1/2"	1/4"	5	5	✓
16325X	★	T25	3/16"	3-1/2"	1/4"	5	5	✓
16327X	★	T27	1/4"	3-1/2"	1/4"	5	5	✓
16330X	★	T30	1/4"	3-1/2"	1/4"	5	5	✓
16610X	★	T10	5/32"	6"	1/4"	5	5	✓
16615X	★	T15	5/32"	6"	1/4"	5	5	✓
16620X	★	T20	3/16"	6"	1/4"	5	5	✓
16625X	★	T25	3/16"	6"	1/4"	5	5	✓
16627X	★	T27	1/4"	6"	1/4"	5	5	✓
16630X	★	T30	1/4"	6"	1/4"	5	5	✓
16640X	★	T40	5/16"	6"	1/4"	5	5	✓





**POWER DRIVE TORX BITS**

**1/4" HEX POWER DRIVE TORX BITS**

URREA



- Made of S2 steel for continuous use in production lines and assembly processes.
- Exceeds ASME B107.600 and ISO 1173 standards.

ITEM	TYPE TIP	TIP SIZE	TIP DIAMETER	TOTAL LENGTH (A)	SHANK	PIECES PER BOX	☞	AVAILABLE
16040	★	T6	0.065"	1-15/16"	1/4"	10	10	✓
16004	★	T8	0.086"	1-15/16"	1/4"	10	10	✓
16012	★	T10	0.107"	1-15/16"	1/4"	10	10	✓
16016	★	T15	0.128"	1-15/16"	1/4"	10	10	✓
16020	★	T20	0.151"	1-15/16"	1/4"	10	10	✓
16025	★	T25	0.245"	1-15/16"	1/4"	10	10	✓
16032	★	T30	0.216"	1-15/16"	1/4"	10	10	✓
16308	★	T8	0.125"	3-1/2"	1/4"	6	6	✓
16310	★	T10	0.125"	3-1/2"	5/16"	6	6	✓
16315	★	T15	0.187"	3-1/2"	5/16"	6	6	✓
16320	★	T20	0.187"	3-1/2"	1/4"	6	6	✓
16325	★	T25	0.245"	3-1/2"	1/4"	6	6	✓
16330	★	T30	0.245"	3-1/2"	1/4"	6	6	✓
16340	★	T40	0.250"	3-1/2"	1/4"	6	6	✓
16615	★	T15	0.187"	6"	1/4"	6	6	✓
16625	★	T25	0.245"	6"	1/4"	6	6	✓
16630	★	T30	0.245"	6"	1/4"	6	6	✓



DRIVERS TOOLS



**1/4" HEX POWER DRIVE TORX BITS**

SURTEK

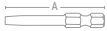

- Made of S2 steel.
- Complies with ASME B107.600 and ISO 1173 standards.

ITEM	TYPE TIP	TIP SIZE	TOTAL LENGTH (A)	SHANK	PIECES PER BOX	☞	AVAILABLE
PT062	★	T6	2"	1/4"	5	1	On Request
PT072	★	T7	2"	1/4"	5	1	On Request
PT082	★	T8	2"	1/4"	5	1	On Request
PT092	★	T9	2"	1/4"	5	1	On Request
PT0102	★	T10	2"	1/4"	5	1	On Request
PT0152	★	T15	2"	1/4"	5	1	On Request
PT0202	★	T20	2"	1/4"	5	1	On Request
PT0252	★	T25	2"	1/4"	5	1	On Request
PT0272	★	T27	2"	1/4"	5	1	On Request
PT0302	★	T30	2"	1/4"	5	1	On Request
PT0402	★	T40	2"	1/4"	5	1	On Request



PT0102



NEW

**1/4" HEX DRIVE TORX SCREWDRIVER BITS**

SURTEK

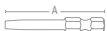

- Made of S2 steel.
- Complies with ASME B107.600 and ISO 1173 standards.

ITEM	TYPE TIP	TIP SIZE	TOTAL LENGTH (A)	SHANK	PIECES PER POLYBAG	☞	AVAILABLE
PT10	★	T10	1"	1/4"	10	1	On Request
PT15	★	T15	1"	1/4"	10	1	On Request
PT20	★	T20	1"	1/4"	10	1	On Request
PT25	★	T25	1"	1/4"	10	1	On Request
PT30	★	T30	1"	1/4"	10	1	On Request
PT252	★	T25	2"	1/4"	10	1	On Request
PT302	★	T30	2"	1/4"	10	1	On Request



PT10



## POWER DRIVE TORX BITS

### 1/4" HEX POWER DRIVE TORX TAMPER BITS



NEW

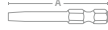

- Made of S2 steel.
- Complies with ASME B107.600 and ISO 1173 standards.

ITEM	TYPE TIP	TIP SIZE	TOTAL LENGTH (A)	SHANK	PIECES PER BOX	⊕	AVAILABLE
PTS102	☆	T10	2"	1/4"	5	1	On Request
PTS152	☆	T15	2"	1/4"	5	1	On Request
PTS202	☆	T20	2"	1/4"	5	1	On Request
PTS252	☆	T25	2"	1/4"	5	1	On Request
PTS272	☆	T27	2"	1/4"	5	1	On Request
PTS302	☆	T30	2"	1/4"	5	1	On Request
PTS402	☆	T40	2"	1/4"	5	1	On Request



PTS402



## POWER DRIVE SQUIRE BITS

### 1/4" HEX POWER DRIVE SQUIRE BITS



- Made of S2 steel for continuous use in production lines and assembly processes.
- Designed to work with electric or pneumatic power tools, handling high applied torque.
- Exceeds ASME B107.600 and ISO 1173 standards.

ITEM	TYPE TIP	SCREW SIZE	TIP SIZE	DRIVE	TOTAL LENGTH (A)	SHANK	PIECES PER POLYBAG	⊕	AVAILABLE
13054X	■	8, 9, 10	2	3/16"	1-15/16"	1/4"	5	5	✓
13058X	■	12, 14, 1/4	3	1/4"	1-15/16"	1/4"	5	5	✓



13054X



### 1/4" HEX POWER DRIVE SQUARE BITS

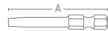

- Made of S2 steel for continuous use in production lines and assembly processes.
- Exceeds ASME B107.600 and ISO 1173 standards.

ITEM	TYPE TIP	SCREW SIZE	TIP SIZE	DRIVE	TOTAL LENGTH (A)	SHANK	PIECES PER BOX	⊕	AVAILABLE
13054	■	8, 9, 10	2	0.112"	1-15/16"	1/4"	10	10	✓
13058	■	12, 14, 1/4	3	0.134"	1-15/16"	1/4"	10	10	✓



13054



## POWER DRIVE HEXAGONAL BITS

### 1/4" HEX POWER DRIVE SAE HEXAGONAL BITS



NEW



- Made of S2 steel.
- Complies with ASME B107.600 and ISO 1173 standards.

ITEM	TYPE TIP	TIP SIZE	TOTAL LENGTH (A)	SHANK	PIECES PER BOX	⊕	AVAILABLE
PHE3322	◆	3/32"	2"	1/4"	5	1	On Request
PHE182	◆	1/8"	2"	1/4"	5	1	On Request
PHE5322	◆	5/32"	2"	1/4"	5	1	On Request
PHE3162	◆	3/16"	2"	1/4"	5	1	On Request
PHE142	◆	1/4"	2"	1/4"	5	1	On Request
PHE5162	◆	5/16"	2"	1/4"	5	1	On Request



PHE3322



### 1/4" HEX POWER DRIVE METRIC HEXAGONAL BITS



NEW

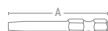

- Made of S2 steel.
- Complies with ASME B107.600 and ISO 1173 standards.

ITEM	TYPE TIP	TIP SIZE	TOTAL LENGTH (A)	SHANK	PIECES PER BOX	⊕	AVAILABLE
PHE22	◆	2 mm	2"	1/4"	5	1	On Request
PHE32	◆	3 mm	2"	1/4"	5	1	On Request
PHE42	◆	4 mm	2"	1/4"	5	1	On Request
PHE52	◆	5 mm	2"	1/4"	5	1	On Request
PHE62	◆	6 mm	2"	1/4"	5	1	On Request
PHE82	◆	8 mm	2"	1/4"	5	1	On Request



PHE22



**DRIVE COMBINED BITS SETS**

**3/8" HEXAGONAL DRIVE COMBINED BITS AND DRILL HOLDER SET WITH ADAPTER**



**44**  
PIECES



- Metal case for easy storage and transport.
- Two different lengths to suit various types of work.
- High torque resistance.
- Includes 1/2" and 3/8" adapters.

Tip	Description	Length	Pieces
Hex	4 mm, 5 mm, 6 mm, 7 mm, 8 mm, 10 mm, 12 mm	36 mm	7
		80 mm	7
Torx®	T20, T25, T27, T30, T40, T45, T50, T55, T60	36 mm	9
		80 mm	9
Bristol®	M5, M6, M8, M10, M12	36 mm	5
		80 mm	5
Bits adapter	3/8" x 10 mm, 1/2" x 10 mm		2



ITEM	PIECES	AVAILABILITY
60244	44	1 On Request

**1/4" HEXAGONAL DRIVE COMBINED BITS AND DRILL HOLDER SET**



**42**  
PIECES



- Metal case for easy storage and transport.
- High torque resistance.
- Precision finish for a perfect fit.

Tip	Description	Length	Pieces
Hex	1.5 mm, 2 mm, 2.5 mm, 3 mm, 4 mm, 5 mm, 6 mm, 7 mm, 8 mm, 10 mm	36 mm	10
		36 mm	11
Security Torx®	T6, T7, T8, T9, T10, T15, T20, T25, T27, T30, T40	36 mm	11
Slotted	3 x 0.5 mm, 3.5 x 0.6 mm, 4 x 0.5 mm, 4.5 x 0.6 mm, 5 x 0.8 mm, 5.5 x 0.8 mm, 6 x 1.0 mm, 6.5 x 1.2 mm, 7 x 1.2 mm, 8 x 1.2 mm	36 mm	10
		36 mm	4
Phillips®	PH0, PH1, PH2, PH3	36 mm	4
Pozidrive®	PZ1, PZ2, PZ3	36 mm	3
Square Robertson®	RB0, RB1, RB2, RB3	36 mm	4



ITEM	PIECES	AVAILABILITY
60242	42	1 ✓

**3/8" HEXAGONAL DRIVE TORX BIT SET WITH ADAPTER**



**15**  
PIECES



- Metal case for easy storage and transport.
- Two different lengths to suit various types of work.
- High torque resistance.
- Includes 1/2" adapter.



Tip	Description	Length	Pieces
Torx®	T20, T25, T30, T40, T45, T50, T55	36 mm	7
		80 mm	7
H 1/2" x 10 mm bit adapter			1

ITEM	PIECES	AVAILABILITY
J2315	15	1 ✓

**3/8" HEXAGONAL DRIVE SAE HEXAGONAL BIT SET WITH ADAPTER**



**15**  
PIECES



- Metal case for easy storage and transport.
- Two different lengths to suit various types of work.
- High torque resistance.
- Includes 1/2" adapter.



Tip	Description	Length	Pieces
Hex	5/32", 3/16", 7/32", 1/4", 5/16", 3/8", 7/16"	36 mm	7
		80 mm	7
H 1/2" x 10 mm bit adapter			1

ITEM	PIECES	AVAILABILITY
J2415	15	1 ✓

**3/8" HEXAGONAL DRIVE METRIC HEXAGONAL BIT SET WITH ADAPTER**



**15**  
PIECES



- Metal case for easy storage and transport.
- Two different lengths to suit various types of work.
- High torque resistance.
- Includes 1/2" adapter.



Tip	Description	Length	Pieces
Hex	4 mm, 5 mm, 6 mm, 7 mm, 8 mm, 10 mm, 12 mm	36 mm	7
		80 mm	7
H 1/2" x 10 mm bit adapter			1

ITEM	PIECES	AVAILABILITY
J2415M	15	1 On Request

**3/8" HEXAGONAL DRIVE TORX BIT SET WITH ADAPTER**



**15**  
PIECES



- Two different lengths to suit various types of work.
- High torque resistance.
- Includes 3/8" adapter.

Tip	Description	Length	Pieces
Torx®	T10, T15, T20, T27, T30	30 mm	5
		75 mm	9
H 3/8" x 10 mm bit adapter			1

ITEM	PIECES	AVAILABILITY
J230	15	1 ✓

**3/8" HEXAGONAL DRIVE BRISTOL BIT SET WITH ADAPTER**



**11**  
PIECES



- Metal case for easy storage and transport.
- Two different lengths to suit various types of work.
- High torque resistance.
- Includes 3/8" adapter.

Tip	Description	Length	Pieces
Bristol	M5, M6, M8, M10, M12	36 mm	5
		80 mm	5
H 3/8" x 10 mm bit adapter			1

ITEM	PIECES	AVAILABILITY
J6011	11	1 ✓



## BIT SETS

### BIT SETS



- Made of chrome vanadium steel.
- Complies with ASME B107.600 standard.

Tip	Description	Pieces
Phillips®	PH0, PH1, PH2, PH3	8
Slotted	3, 4, 4.5, 5, 5.5, 6, 6.5, 7, 8 mm	9
Pozidrive	PZ0, PZ1, PZ2, PZ3	8
Drive	S0, S, S2, S3	4
Torx®	T8, T10, T15, T20, T25, T27, T30, T40, T45	9
Torx® Tamper proof	T8, T10, T15, T20, T25, T27, T30, T35, T40	9
SAE hex	1/16", 5/64", 3/32", 7/64", 1/8", 9/64", 5/32", 3/16", 7/32", 1/4"	10
Metric hex	1.5, 2, 2.5, 3, 4, 5, 5.5, 6, 8 mm	9
SAE hex tamper proof	5/64", 3/32", 7/64", 1/8", 9/64", 5/32"	6
Metric hex tamper proof	2, 2.5, 3, 4, 5, 6 mm	6
Triple square	M5, M6, M8	3
Torque	6, 8, 10	3
Triwing	1, 2, 3, 4	4
Spanner	SP4, SP6, SP8, SP10	4
Clutch	1, 2, 3	3
1/4" x 2" Magnetic power adapter		3
1/4" x 1" Bit adapter		1
1/4" x 1" y 1/4" x 2" Extensions		1
1/4" Butterfly adaptor		2
Plastic box		1

ITEM	PIECES	AVAILABLE
PFC100	100	1 On Request



- Made of chrome vanadium steel.
- Complies with ASME B107.600 standard.

Type	Tips	Pieces
Phillips®	PH0, PH1, PH2, PH3	9
Slotted	5-6, 6-8, 8-10, 10-12	4
Pozidrive	PZ0, PZ1, PZ2, PZ3	4
Drive	S1, S2, S3	6
Torx®	T10, T15, T20, T25, T30, T40	6
SAE hex bits	3/32", 1/8", 5/32", 3/16", 7/32", 1/4"	6
1/4" Magnetic bit holder		1
Plastic case		1

ITEM	PIECES	AVAILABLE
PFC33	33	1 On Request



- Made of chrome vanadium steel.
- Complies with ASME B107.600 standard.

Tip	Description	Length	Pieces
Phillips®	PH1, PH2	3"	2
Slotted	3, 4, 4.5, 5, 5.5, 6, 6.5, 7, 8 mm	1"	9
Drive	S0, S1, S2, S3	3"	2
Torx®	T8, T10, T15, T20, T25, T27, T30, T40, T45	1"	4
Torx® Tamper proof	T8, T10, T15, T20, T25, T27, T30, T35, T40	1"	9
SAE hex	1/16", 5/64", 3/32", 7/64", 1/8", 9/64", 5/32", 3/16", 7/32", 1/4"	1"	9
Metric hex	1.5, 2, 2.5, 3, 4, 5, 5.5, 6, 8 mm	3"	3
SAE hex tamper proof	5/64", 3/32", 7/64", 1/8", 9/64", 5/32"	1"	6
Metric hex tamper proof	2, 2.5, 3, 4, 5, 6 mm	1"	6
Triple square	M5, M6, M8	1"	3
Torque	6, 8, 10	1"	3
Tri wing	1, 2, 3, 4	3"	3
Spanner	SP4, SP6, SP8, SP10	1"	4
Clutch	SP4, SP6, SP8, SP10	1"	4
1/4" x 2-3/8" Magnetic bits adapter		1"	3
1/4" x 1/4" Socket adapter		1"	1
1/4" x 2-3/8" Magnetic bits adapter		1"	1
1/4" Couple		1"	1
Plastic case			1

ITEM	PIECES	AVAILABLE
PFC99	99	1 On Request



- Made of chrome vanadium steel.
- Complies with ASME B107.600 standard.

Tip	Tips	Pieces
Phillips®	PH1, PH2, PH3	4
Slotted	6-8, 8-10, 10-12	3
Pozidrive	PZ1, PZ2, PZ3	3
Drive	S1, S2, S3	3
Torx®	T15, T20, T25, T30	4
SAE hex	1/8", 3/32", 5/32"	3
Nutsetters	3/16", 1/4", 5/16", 11/32", 3/8"	5
1/4" x 2" magnetic bit adapter		1

ITEM	PIECES	AVAILABLE
PFC29	26	1 On Request

**BIT SETS**

**BIT SETS**



**20**  
PIECES



- Made of chrome vanadium steel.
- Complies with ASME B107.600 standard.

Tip	Tips	Pieces
⊕ Phillips®	PH1, PH2, PH3	3
⊖ Slotted	3-4, 6-8, 10-12, 12-14 mm	4
★ Torx®	T10, T15, T20, T25, T30, T40	6
● Metric hex bits	2, 2.5, 3, 4, 5, 6, 8 mm	7



ITEM	PIECES	AVAILABLE
<b>PFC20</b>	20	6 On Request



**5**  
PIECES



- Made of chrome vanadium steel.
- Complies with ASME B107.600 standard.

Tip	Tips	Pieces
⊕ Phillips®	PH0, PH1, PH2	3
⊖ Slotted	3/16", 1/4"	2



ITEM	PIECES	AVAILABLE
<b>PF515</b>	5	12 On Request

**3/8" TORX® BIT SET WITH ADAPTER**



**15**  
PIECES



**NEW**

- Made of chrome vanadium steel.
- Complies with ASME B107.600 standard.

Tip	Description	Length	Pieces
★ Torx®	T10, T15, T20, T27, T30	1"	5
	T20, T25, T30, T40, T45, T47, T50, T55, T60	3"	9
	3/8" Bit adapter		1



ITEM	PIECES	AVAILABLE
<b>PFB15</b>	15	1 On Request

**1/4" HEX DRIVE TORX BIT SET WITH ADAPTER**



**9**  
PIECES



- Made of chrome vanadium steel.
- Complies with ASME B107.600 standard.

Tip	Description	Pieces
★ Torx®	T8, T10, T15, T20, T25, T27, T30, T40	8
	1/4" Bit adapter	1



ITEM	PIECES	AVAILABLE
<b>PFTX9</b>	9	1 On Request



**7**  
PIECES



- Made of chrome vanadium steel.
- Complies with ASME B107.600 standard.

Tip	Description	Pieces
★ Torx®	T10, T15, T20, T25, T30, T40	6
	1/4" Bit adapter	1



ITEM	PIECES	AVAILABLE
<b>PFT7</b>	7	6 On Request

**1/4" HEX DRIVE SECURITY TORX BIT SET**



**9**  
PIECES



- Made of chrome vanadium steel.
- Complies with ASME B107.600 standard.

Tip	Description	Pieces
★ Torx®	T8, T10, T15, T20, T25, T27, T30, T40	8
	1/4" Bit adapter	1



ITEM	PIECES	AVAILABLE
<b>PFT9</b>	9	12 On Request

**1/4" HEX DRIVE BRISTOL BIT SET**



**4**  
PIECES



- Made of chrome vanadium steel.
- Complies with ASME B107.600 standard.

Tip	Description	Pieces
● Bristol	6, 8, 10, 12 mm	4



ITEM	PIECES	AVAILABLE
<b>PFB4</b>	4	1 On Request

## DRIVE INTERCHANGEABLE SCREWDRIVER BITS

### 1/4" HEXAGONAL DRIVE INTERCHANGEABLE PHILLIPS 3" AND SLOTTED 8 - 10" SCREWDRIVER BIT

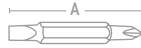

- Made of S2 steel for continuous use in production lines and assembly processes.
- Exceeds ASME B107.600 and ISO 1173 standards.

ITEM	PHILLIPS® TIP SIZE	SCREW SIZE	TIP THICKNESS	TIP WIDTH	TOTAL LENGTH (A)	SHANK	PIECES PER BOX	☞	AVAILABLE
30004	PH 2	8 - 10	0.038"	1/4"	1-1/2"	1/4"	10	10	✓



### 1/4" HEX DOUBLE DRIVE PHILLIPS SCREWDRIVER BIT#2 AND SLOTTED BIT 9/32", 2" 5



- Made of S2 steel.
- Complies with ASME B107.600 and ISO 1173 standards.

ITEM	PHILLIPS® TIP SIZE	TIP SIZE	TIP THICKNESS	TIP WIDTH	TOTAL LENGTH (A)	SHANK	PIECES PER BOX	☞	AVAILABLE
PDP2932	PH 2	9/32"	0.038"	1/4"	2"	1/4"	5	1	On Request



### "1/4" HEX DOUBLE DRIVE PHILLIPS SCREWDRIVER BIT#2 AND SLOTTED BIT 1/4", 1-1/2" 10



- Made of S2 steel.
- Complies with ASME B107.600 and ISO 1173 standards.

ITEM	PHILLIPS® TIP SIZE	SCREW SIZE	TIP THICKNESS	TIP WIDTH	TOTAL LENGTH (A)	SHANK	PIECES PER POLYBAG	☞	AVAILABLE
PPH2PL	PH 2	1/4"	0.038"	1/4"	1-1/2"	1/4"	10	1	On Request



## DRIVE PHILLIPS SCREWDRIVER BITS

### HEXAGONAL DRIVE PHILLIPS SCREWDRIVER BITS



- Made of S2 steel for continuous use in production lines and assembly processes.
- Exceeds ASME B107.600 and ISO 1173 standards.

ITEM	TYPE TIP	TIP SIZE	TIP DIAMETER	TOTAL LENGTH (A)	SHANK	PIECES PER BOX	☞	AVAILABLE
20004	+	PH 1	13/64"	1"	1/4"	25	25	✓
20008	+	PH 2	15/64"	1"	1/4"	25	25	✓
20040	+	PH 2 Reducida	3/16"	1"	1/4"	25	25	✓
20012	+	PH 3	15/64"	1"	1/4"	25	25	✓
21108	+	PH 2	—	1-1/2"	5/16"	5	5	✓
21112	+	PH 3	—	1-1/2"	5/16"	5	5	✓



21112



20004



### HEX DRIVE PHILLIPS BITS



- Made of S2 steel.
- Complies with ASME B107.600 and ISO 1173 standards.

ITEM	TYPE TIP	TIP SIZE	TOTAL LENGTH (A)	SHANK	PIECES PER BLISTER	☞	AVAILABLE
PF511	+	#1	1"	1/4"	5	12	On Request
PF512	+	#2	1"	1/4"	5	12	On Request



PF512



DRIVE PHILLIPS SCREWDRIVER BITS

HEX DRIVE PHILLIPS SCREWDRIVER BITS



- Ideal for controlling screw depth in drywall
- Made of S2 steel.
- Complies with ASME B107.600 and ISO 1173 standards.

ITEM	TYPE TIP	SIZE TIP	TOTAL LENGTH (A)	SHANK	PIECES PER BOX	⊞	AVAILABLE
PPT21	+	#2	1"	1/4"	5	1	On Request



DRIVE TORX SCREWDRIVER BITS

1/4" HEXAGONAL DRIVE TORX SCREWDRIVER BITS



- Made of S2 steel for continuous use in production lines and assembly processes.
- Exceeds ASME B107.600 and ISO 1173 standards.

ITEM	TYPE TIP	SIZE TIP	TIP DIAMETER	TOTAL LENGTH (A)	SHANK	PIECES PER BOX	⊞	AVAILABLE
23016	T15	T15	0.128"	1"	1/4"	10	10	✓
23020	T20	T20	0.151"	1"	1/4"	10	10	✓
23024	T25	T25	0.173"	1"	1/4"	10	10	✓
23032	T30	T30	0.216"	1"	1/4"	10	10	✓
23036	T40	T40	0.260"	1"	1/4"	10	10	✓
23050	T30	T30	0.216"	1-1/4"	5/16"	10	10	✓
23054	T40	T40	0.260"	1-1/4"	5/16"	10	10	✓



23016



23050



1/4" HEXAGONAL DRIVE TORX TAMPER-PROOF SCREWDRIVER BITS



- Made of S2 steel for continuous use in production lines and assembly processes.
- Exceeds ASME B107.600 and ISO 1173 standards.

ITEM	TYPE TIP	SIZE TIP	TIP DIAMETER	TOTAL LENGTH (A)	SHANK	PIECES PER BOX	⊞	AVAILABLE
23014	T10	T10	0.107"	1"	1/4"	10	10	✓
23018	T15	T15	0.128"	1"	1/4"	10	10	✓
23022	T20	T20	0.151"	1"	1/4"	10	10	✓
23026	T25	T25	0.173"	1"	1/4"	10	10	✓
23030	T27	T27	0.192"	1"	1/4"	10	10	✓
23034	T30	T30	0.216"	1"	1/4"	10	10	✓
23038	T40	T40	0.260"	1"	1/4"	10	10	✓



23014



HEXAGONAL DRIVE SCREWDRIVER BITS

1/4" HEXAGONAL DRIVE SCREWDRIVER BITS



- Made of S2 steel for continuous use in production lines and assembly processes.
- Exceeds ASME B107.600 and ISO 1173 standards.

ITEM	TYPE TIP	SIZE TIP	TOTAL LENGTH (A)	SHANK	PIECES PER BOX	⊞	AVAILABLE
24016	Hex	5/32"	1-1/4"	1/4"	10	10	✓
24020	Hex	3/16"	1-1/4"	1/4"	10	10	✓



24016



## DRIVE BRISTOL SCREWDRIVER BITS

### HEXAGONAL DRIVE BRISTOL SCREWDRIVER BITS



**S2 ALLOY**  
BIT MATERIAL

**URREA**  
Tools for Professionals



60760



60780



- Ideal for fasteners used in vehicles from Audi®, BMW®, Mercedes-Benz®, Porsche®, and Volkswagen®
- Made of S2 steel for continuous use in production lines and assembly processes.
- Exceeds ASME B107.600 and ISO 1173 standards.



ITEM	BRISTOL BIT SETS	
	JPB60	J607
PIECES	7	4
PACKING		
AVAIL.	1	1

ITEM	TYPE TIP	TIP SIZE	TOTAL LENGTH (A)	SHANK	PIECES PER BOX	AVAIL.	JPB60	J607
60760		M 6	2-1/2"		6	✓	•	•
60770		M 8	3"		6	✓	•	•
60780		M 10	2-7/8"		3	✓	•	•
60790		M 12	2-7/8"		3	✓	•	•
60800		M 14	3"		2	✓	•	•
60810		M 16	3"		2	✓	•	•
60820		M 18	3"		2	✓	•	•

### HEX DRIVE BRISTOL SCREWDRIVER BITS



**SURTEK**  
Tools for Specialists



PB8



- Made of S2 steel.
- Complies with ASME B107.600 and ISO 1173 standards.

ITEM	TYPE TIP	TIP SIZE	TOTAL LENGTH (A)	SHANK	PIECES PER POLYBAG	AVAIL.
PB8		8 mm	75 mm		5	On Request
PB12		12 mm	75 mm		5	On Request



## DRIVE HEXAGONAL BIT RATCHETES

### DRIVE HEXAGONAL BIT RATCHETES



**URREA**  
Tools for Professionals

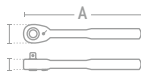

- Allows greater torque compared to using a conventional bit screwdriver.
- Made of chrome vanadium steel.
- Exceeds ASME B107.110 standard.



ITEM	HEX DRIVE	TOTAL LENGTH (A)	HEAD WIDTH (B)	HEAD THICKNESS (C)	TEETH	SWING ARC	AVAIL.
4749T	1/4"	4"	13/16"	3/8"	60	6°	✓



DRIVE BIT ADAPTERS

5/16" HEXAGONAL DRIVE MAGNETIC BIT ADAPTERS



URREA



- Made of S2 steel for continuous use in production lines and assembly processes.
- Exceeds ASME B107.600 and ISO 1173 standards.



ITEM	HEX SHANK	BODY DIAMETER	TOTAL LENGTH(A)	SHANK	PIECES PER POLYBAG	⊞	AVAILABLE
56020X	5/16"	7/16"	2-1/2"	1/4"	1	⊞	On Request
56120X	5/16"	7/16"	2-1/2"	5/16"	1	⊞	On Request



1/4" HEXAGONAL DRIVE BIT ADAPTERS WITH RETENTION RING



URREA



- Made of S2 steel for continuous use in production lines and assembly processes.
- Exceeds ASME B107.600 and ISO 1173 standards.



ITEM	HEX SHANK	BODY DIAMETER	FOR TIPS	TOTAL LENGTH (A)	SHANK	PIECES PER POLYBAG	⊞	AVAILABLE
55010	1/4"	7/16"	1/4"	2-15/16"	1/4"	6	⊞	✓



1/4" HEXAGONAL DRIVE BIT ADAPTERS WITH RETENTION RING



URREA



- Designed with a threaded locking system and plastic retaining ring.
- Made of S2 steel for continuous use in production lines and assembly processes.
- Exceeds ASME B107.600 and ISO 1173 standards.



ITEM	HEX SHANK	BODY DIAMETER	FOR TIPS	TOTAL LENGTH (A)	SHANK	PIECES PER POLYBAG	⊞	AVAILABLE
55012	1/4"	7/16"	1/4"	2-31/32"	1/4"	6	⊞	✓



1/4" HEX POWER DRIVE BIT ADAPTERS MAGNETIC



URREA



- Magnetic adapter that securely holds power bits, preventing them from easily coming loose.
- Made of S2 steel for continuous use in production lines and assembly processes.
- Exceeds ASME B107.600 and ISO 1173 standards.



ITEM	HEX SHANK	BODY DIAMETER	FOR TIPS	TOTAL LENGTH (A)	SHANK	PIECES PER POLYBAG	⊞	AVAILABLE
55004	1/4"	7/16"	1/4"	2-1/4"	1/4"	6	⊞	✓



1/4" HEX POWER DRIVE BIT ADAPTERS MAGNETIC



SURTEK



NEW



- Made of chrome vanadium steel.
- Complies with ASME B107.600 and ISO 1173 standards.

ITEM	TIP SIZE	BODY DIAMETER	FOR TIPS	TOTAL LENGTH (A)	SHANK	PIECES PER BOX	⊞	AVAILABLE
PEX147	1/4"	7/16"	1/4"	2-3/4"	1/4"	5	⊞	On Request



## DRIVE BIT ADAPTERS

### 1/4" HEX POWER DRIVE BIT ADAPTERS MAGNETIC



- Made of chrome vanadium steel.
- Complies with ASME B107.600 and ISO 1173 standards.

ITEM	TIP SIZE	BODY DIAMETER	FOR TIPS	TOTAL LENGTH (A)	SHANK	PIECES PER POLYBAG	☞	AVAILABLE
PEM1/4	1/4"	7/16"	1/4"	2-53/64"	1/4"	10	1	On Request



### 1/4", 3/8" AND 1/2" MALE SQUEAR ADAPTER SET



**3**  
PIECES



- Allows use of 1/4", 3/8", and 1/2" square drives with electric screwdrivers or bit drivers.
- Made of chrome vanadium steel.
- Complies with ISO 1173 standard.

ITEM	PIECES	☞	AVAILABLE
105120	3	1	On Request



### 1/4" HEX POWER DRIVE ADAPTERS WITH PIN FOR 1/4" FEMALE DRIVE



- Made of S2 steel for continuous use in production lines and assembly processes.
- Exceeds ISO 1173 standards.

ITEM	SQUARE DRIVE	TOTAL LENGTH (A)	SHANK	PIECES PER POLYBAG	☞	AVAILABLE
50004X	1/4"	2"	1/4"	1	1	✓
50104X	3/8"	2"	1/4"	1	1	✓

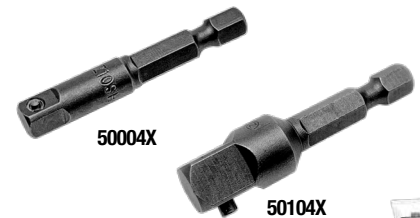

### 1/4" HEX POWER DRIVE ADAPTERS WITH PIN FOR 1/4" FEMALE DRIVE



- Made of S2 steel for continuous use in production lines and assembly processes.
- Exceeds ISO 1173 standards.

ITEM	DRIVE	TOTAL LENGTH (A)	SHANK	PIECES PER BOX	☞	AVAILABLE
50004	1/4"	2"	1/4"	6	6	✓
50012	1/4"	4"	1/4"	6	6	✓
50020	1/4"	6"	1/4"	6	6	✓



### 1/4" HEX POWER DRIVE ADAPTERS WITH STEEL BALL FOR 1/4" FEMALE DRIVE



- Made of S2 steel for continuous use in production lines and assembly processes.
- Exceeds ISO 1173 standards.

ITEM	DRIVE	TOTAL LENGTH (A)	SHANK	PIECES PER BOX	☞	AVAILABLE
50006	1/4"	2"	1/4"	6	6	✓



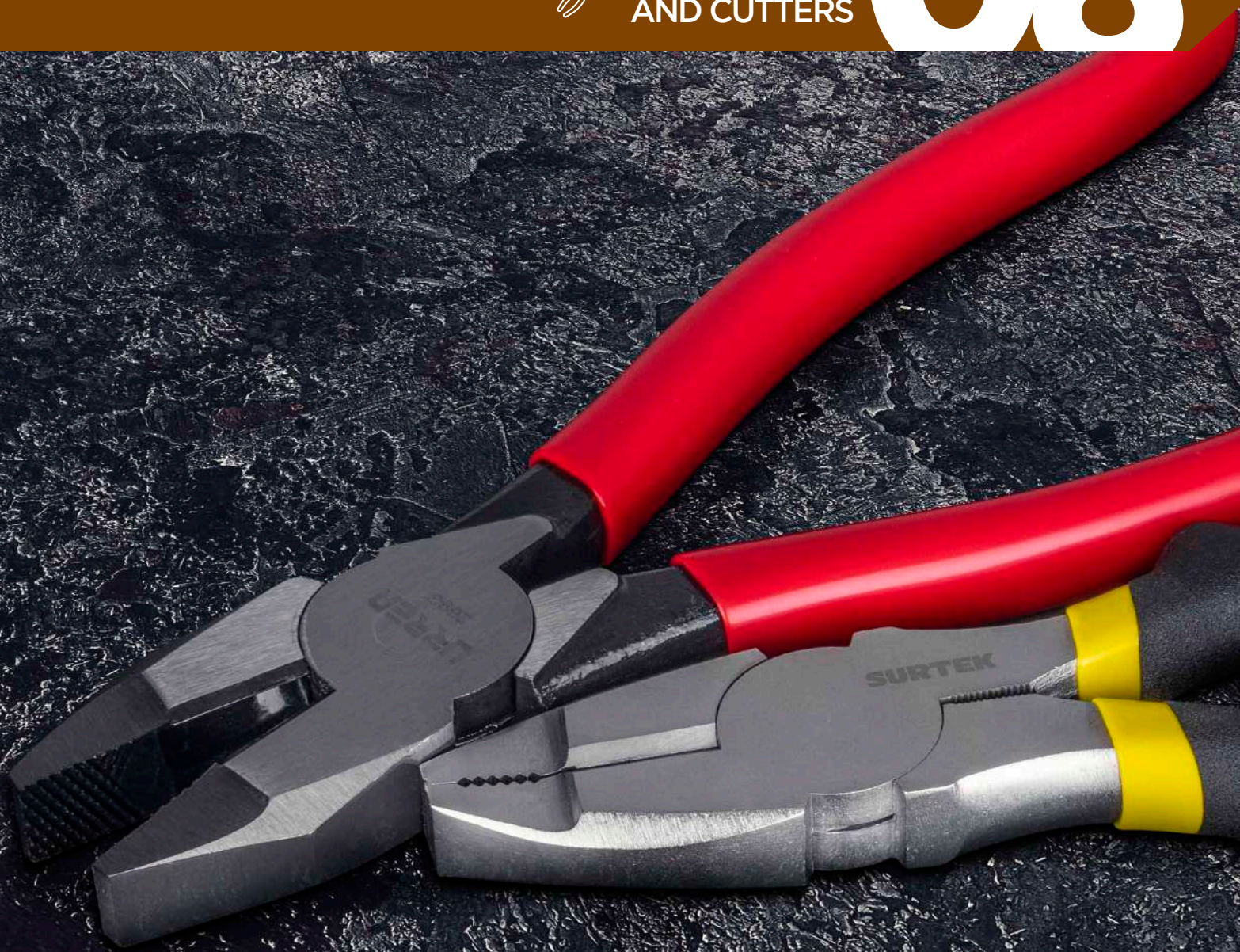

CLASS	TYPE	PAGE	BRAND	
			URREA	SURTEK
Bolt cutters	Bolt cutters	282	•	•
Pliers	Retaining ring pliers	283	•	•
	Flush cut pliers	287	•	•
	Electrician pliers	287	•	•
	Groove joint pliers	295	•	•
	Safety wire twist pliers	295	•	•
	Fencing plier	296	•	•
	Mechanic's pliers	296	•	•
	Folding multi-tool	297	•	•
	Wire stripping pliers	297	•	•
	Specialty tweezers	299	•	•
	Locking pliers	301	•	•
	Half cut pincers	305	•	•
Tin snips	Cable and wire cutters	305	•	•
	Aviation tin snips	305	•	•

[usa.urrea.com](http://usa.urrea.com)

We are constantly improving our products, that is why the information, characteristics and availability of them can change without prior notice.

## BOLT CUTTERS

### FORGED BOLT CUTTERS

**HEAVY DUTY**

Design of jaws that ensure the best distribution of applied force and easier cutting.

Forged steel body.

Black jaws.

Handles closer together for more cutting power with less strain.

Jaw hardness from 57 to 62 HRC.

Chrome vanadium #60 jaws.

URREA  
SUPERIOR QUALITY AFFORDABLE TOOLS

IMPROVED PRODUCT

• Exceed GGG-C-740d standard.

ITEM	LENGTH	SOFT METAL	MEDIUM METAL	HARD METAL	⊞	AVAILABLE
COP14	14"	3/16"	1/4"	5/16"	1	On Request
COP18	18"	1/4"	5/16"	3/8"	1	On Request
COP24	24"	5/16"	3/8"	7/16"	1	On Request
COP30	30"	3/8"	7/16"	1/2"	1	On Request
COP36	36"	7/16"	1/2"	9/16"	1	On Request

### FOLDABLE BOLT CUTTERS

**HEAVY DUTY**

Design of jaws that ensure the best distribution of applied force and easier cutting.

Adjustable telescopic handles, adapt to different work situations.

Black jaws.

Chrome vanadium #50 jaws.

Jaw hardness from 55 to 60 HRC.

Handles closer together for more cutting power with less strain.

Smooth plastic handles.

URREA  
SUPERIOR QUALITY AFFORDABLE TOOLS

• Exceed GGG-C-740d standard.

ITEM	LENGTH	SOFT METAL	MEDIUM METAL	HARD METAL	⊞	AVAILABLE
COP18T	18"	5/16"	1/4"		1	On Request

### FOLDABLE BOLT CUTTERS

**HEAVY DUTY**

Design of jaws that ensure the best distribution of applied force and easier cutting.

Folding handles for easy transport and storage.

Black jaws.

Chrome vanadium #50 jaws.

Jaw hardness from 55 to 60 HRC.

Handles closer together for more cutting power with less strain.

Forged steel body.

URREA  
SUPERIOR QUALITY AFFORDABLE TOOLS

• Exceed GGG-C-740d standard.

ITEM	LENGTH	SOFT METAL	MEDIUM METAL	HARD METAL	⊞	AVAILABLE
COP24P	24"	5/16"	3/8"		1	On Request

### REPLACEMENT BLADE FOR BOLT CUTTERS

**HEAVY DUTY**

Chrome vanadium #60 jaws.

Jaw hardness from 57 to 62 HRC.

Black jaws.

URREA  
SUPERIOR QUALITY AFFORDABLE TOOLS

ITEM	DESCRIPTION	⊞	AVAILABLE
RCOP14	Replacement blade for COP14	1	On Request
RCOP18	Replacement blade for COP18	1	On Request
RCOP24	Replacement blade for COP24	1	On Request
RCOP30	Replacement blade for COP30	1	On Request
RCOP36	Replacement blade for COP36	1	On Request
RCOP24P	Replacement blade for COP24P	1	On Request
RCOP18T	Replacement blade for COP18T	1	On Request

### TUBULAR HANDLE BOLT CUTTERS

**PROFESSIONAL USE**

Composite lever system.

With toothed blades.

Tubular handle.

Forged chrome molybdenum steel jaws.

Handle with PVC coating.

URREA  
SUPERIOR QUALITY AFFORDABLE TOOLS

IMPROVED PRODUCT

• Exceed GGG-C-740d standard.

ITEM	LENGTH	SOFT METAL	HARD METAL	⊞	AVAILABLE
115138	8"	1/8"	3/32"	1	On Request
115139	12"	3/16"	1/8"	1	On Request
115140	14"	9/32"	5/32"	1	On Request
115141	18"	5/16"	3/16"	1	On Request

ITEM	LENGTH	SOFT METAL	HARD METAL	⊞	AVAILABLE
115142	24"	3/8"	7/32"	1	On Request
115144	30"	1/2"	9/32"	1	On Request
115143	36"	5/8"	5/16"	1	On Request

**RETAINING RING PLIERS WITH INTERCHANGEABLE TIPS**

**CONVERTIBLE RETAINING RING PLIER SET WITH INTERCHANGEABLE TIPS**



**HEAVY DUTY** **AIR CUSHION HANDLE** **CONVERTIBLE**

**33**  
PIECES



Convert between internal and external with a quick flip of a switch.

• Exceed ASME B107.19 Standard

Content												
Plier size	Small				Medium				Large			
Tip Size	2	2	2	2	2	2	2	2	2	2	2	2
Angle	0°	90°	0°	90°	0°	90°	0°	90°	0°	15°	90°	15°
Tip diameter	0.038"	0.047"	0.070"		0.024"	0.038"	0.047"		0.090"	0.108"	0.120"	

ITEM	PIECES	AVAILABLE
383	33	1 ✓



**URREA**  
SUPERIOR QUALITY AFFORDABLE TOOLS

usa.urrea.com

PLIERS, SNIPS AND CUTTERS

**LARGE QUICK SWITCH PLIER WITH ADJUSTABLE STOP AND TIP SET**



**HEAVY DUTY** **AIR CUSHION HANDLE** **CONVERTIBLE**

**13**  
PIECES

Convert between internal and external with a quick flip of a switch

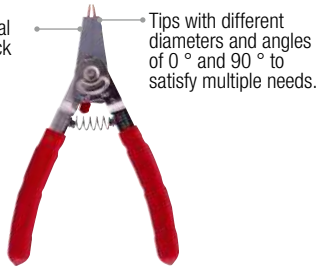

Tips with different diameters and angles of 0° and 90° to satisfy multiple needs.

Content		
Tip Size	Diameter	Angle
2 Tip Size	0.070"	0°
4 Tip Size	0.039"	0° & 90°
4 Tip Size	0.047"	0° & 90°
1 pinza	-	-

• Exceed ASME B107.19 Standard

ITEM	PIECES	MAXIMUM OPENING	AVAILABLE
381	13	2"	1 ✓

**SMALL QUICK SWITCH PLIER WITH ADJUSTABLE STOP AND TIP SET**



**SUPER DUTY** **AIR CUSHION HANDLE** **CONVERTIBLE**

**11**  
PIECES

Convert between internal and external with a quick flip of a switch

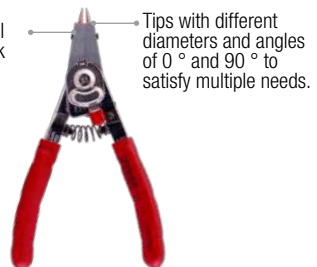

Tips with different diameters and angles of 0° and 90° to satisfy multiple needs.

Content		
Tip Size	Diameter	Angle
2 Tip Size	0.023"	0°
4 Tip Size	0.039"	0° & 90°
4 Tip Size	0.047"	0° & 90°
1 pinza	-	-

• Exceed ASME B107.19 Standard

ITEM	PIECES	MAXIMUM OPENING	AVAILABLE
382	11	1"	1 ✓

**RETAINING RING PLIERS WITH INTERCHANGEABLE HEAD**



**PROFESSIONAL USE** **INTERNAL** **EXTERNAL**

**5**  
PIECES

4 easy-to-install convertible heads for internal and external retaining rings.



• Meet ASME B107.19 Standard

ITEM	PIECES	TIP SIZE	LENGTH	MAXIMUM OPENING	AVAILABLE
PFR01	5	0°, 45°, 90°	6-1/4"	2"	1 On Request

**RETAINING RING PLIERS WITH INTERCHANGEABLE HEAD**



**PROFESSIONAL USE** **INTERNAL** **EXTERNAL**

**3**  
PIECES

2 easy-to-install convertible heads for internal and external retaining rings.



• Meet ASME B107.19 Standard

ITEM	PIECES	TIP SIZE	LENGTH	MAXIMUM OPENING	AVAILABLE
PFR02	3	0°, 45°, 90°	6-1/4"	2"	1 On Request

## RETAINING RING PLIER WITH RATCHETING SYSTEM

### RETAINING RING PLIER WITH RATCHETING SYSTEM

**SUPER DUTY** **AIR CUSHION HANDLE**

**EXTERNAL** **INTERNAL**

Induction hardened and precision machined tips.

The ratcheting mechanism reduces fatigue because the ring is gradually compressed or retained and is locked at the desired size.

• Exceed ASME B107.500 standard.

Cushion grip for comfort

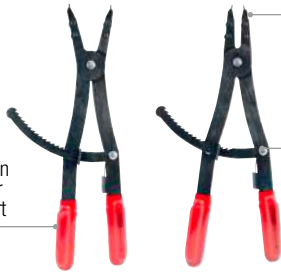

365

364

ITEM	TYPE	TIP DIAMETER	MAXIMUM OPENING	LENGTH	⊞	AVAILABLE
365	External	0.120"	3-1/8"	16-1/2"	1	
364	Internal	0.120"	3-1/8"	16-1/2"	1	

**URREA**  
SUPER DUTY



**IMPROVED PRODUCT**



364RKB

### REPLACEMENT TIP SET FOR MODEL 361

**SUPER DUTY**

**8 PIECES**



361RKB



361RKA

ITEM	PIECES	DESCRIPTION	TIP DIAMETER	⊞	AVAILABLE
361RKB	8	Thick tip	0.120"	1	✓
361RKA	8	Thin tip	0.108"	1	✓

PLIERS, SNIPS AND CUTTERS

## CONVERTIBLE RETAINING RING PLIERS

### CONVERTIBLE RETAINING RING PLIERS SET

**INDUSTRIAL DUTY** **CONVERTIBLE**

**12 PIECES**

Content	Angle	Diameter
	0°	0.038"
	45°	0.038"
	90°	0.038"
	0°	0.047"
	45°	0.047"
	90°	0.047"
	0°	0.070"
	45°	0.070"
	90°	0.070"
	0°	0.090"
	45°	0.090"
	90°	0.090"

Manufactured in tempered steel and finished in corrosion resistant blued finish.

Interior to exterior convertible clamps with easy screw system.  
Double high-resistance vinyl handle for greater comfort.

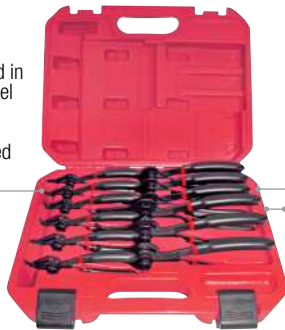

• Exceed ASME B107.500 standard.

ITEM	DESCRIPTION	⊞	AVAILABLE
360C	Convertible retaining ring pliers	1	✓

### CONVERTIBLE RETAINING RING PLIERS SET

**INDUSTRIAL DUTY** **CONVERTIBLE**

**6 PIECES**

Content	Angle	Diameter
	0°	0.038"
	90°	0.038"
	0°	0.047"
	90°	0.047"
	0°	0.070"
	90°	0.070"

Interior to exterior convertible clamps with easy screw system.

Manufactured in tempered steel and finished in corrosion resistant blued finish.



Double high-resistance vinyl handle for greater comfort.



• Exceed ASME B107.500 standard.

ITEM	DESCRIPTION	⊞	AVAILABLE
360D	Convertible retaining ring pliers	1	✓

### QUICK-CHANGE CONVERTIBLE RETAINING RING PLIERS

**HEAVY DUTY** **AIR CUSHION HANDLE** **QUICK CHANGE** **CONVERTIBLE**

Coated with a layer of black oxide and bathed in oil to prevent corrosion.

Internal to external convertible tongs with easy knob system.

Induction hardened and precision machined tips.



399L



385L



374L



• Exceed ASME B107.500 standard.

						PLIER SET		
ITEM	ANGLE	TIP DIAMETER	LENGTH	MAXIMUM OPENING	⊞	AVAILABLE		
399L	0°	0.038"	6"	7/8"	3	✓		
385L	0°	0.070"	7-1/4"	1-3/16"	3	✓		
374L	90°	0.047"	6"	3/4"	3	On Request		
						<b>BULK</b>	1	✓

## CONVERTIBLE RETAINING RING PLIERS

### EASY-CHANGE CONVERTIBLE RETAINING RING PLIERS



URREA



Internal to external convertible tongs with easy half turn butterfly system.

Precision machined, induction hardened tips.

Heat treated steel for durability.



399



377



370



375



371



376



			PLIER SETS	
ITEM	360B	360A		
PIECES	12	6		
PACKING				
	1	1		
AVAILABLE	✓	✓		

ITEM	ANGLE	TIP DIAMETER	LENGTH	MAXIMUM OPENING	✓	AVAILABLE	360B	360A
399	0°	0.038"	5-7/8"	13/16"	3	✓	•	•
372	0°	0.047"	5-7/8"	3/4"	3	✓	•	•
385	0°	0.070"	7-1/2"	1"	3	✓	•	•
377	0°	0.090"	9-1/4"	1-9/16"	3	✓	•	•
370	45°	0.038"	5-3/4"	13/16"	3	✓	•	•
373	45°	0.047"	5-3/4"	3/4"	3	✓	•	•
375	45°	0.070"	7-3/8"	1"	3	✓	•	•
378	45°	0.090"	9"	1-1/2"	3	✓	•	•
371	90°	0.038"	5-11/16"	11/16"	3	✓	•	•
374	90°	0.047"	5-11/16"	11/16"	3	✓	•	•
376	90°	0.070"	7-1/8"	15/16"	3	✓	•	•
379	90°	0.090"	8-5/8"	1-3/8"	3	✓	•	•



• Exceed ASME B107.500 Standard.

### CONVERTIBLE RETAINING RING PLIERS



SURTEK



Internal to external convertible system.

Heat treated steel for durability.



975



976



985



			PLIER SET	
ITEM	P02			
PIECES	3			
PACKING				
	1			
AVAILABLE	On Request			

ITEM	ANGLE	TIP DIAMETER	LENGTH	MAXIMUM OPENING	✓	AVAILABLE
975	45°	0.072"	8"	1"	3	On Request
976	90°	0.072"	8"	1"	3	On Request
985	0°	0.072"	8"	1"	3	On Request



• Meet ASME B107.19 standard.

URREA

SUPERIOR QUALITY AFFORDABLE TOOLS

SUPERIOR  
Grip



usa.urrea.com

CONVERTIBLE RETAINING RING PLIERS SET

## FORGED RETAINING RING PLIERS

### FORGED RETAINING RING PLIERS WITH RUBBER GRIP HANDLE

**SUPER DUTY** **FORGED CLAMP** **RUBBER GRIP**  
 GREATER RESISTANCE

**URREA**  
United States • Canada • Mexico



**IMPROVED PRODUCT**



**VIDEO**

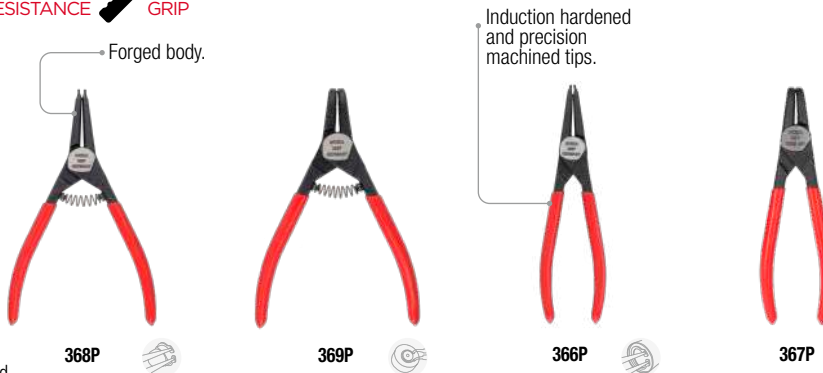

• Exceed ASME B107.500 Standard

ITEM	TIP DIAMETER	ANGLE	TYPE		LENGTH	MAXIMUM OPENING	☐	AVAILABLE
			EXTERNAL	INTERNAL				
368P	0.070"	0°	•		7-1/8"	1-1/2"	1	✓
369P	0.070"	90°	•		6-11/16"	1-13/64"	1	✓
366P	0.070"	0°		•	7-1/8"	1-51/64"	1	✓
367P	0.070"	90°		•	6-11/16"	1-19/64"	1	✓

### FORGED RETAINING RING PLIERS WITH VINYL HANDLE

**INDUSTRIAL DUTY** **FORGED CLAMP** **GREATER RESISTANCE**

**URREA**  
United States • Canada • Mexico



• Exceed ASME B107.500 Standard

ITEM	TIP DIAMETER	ANGLE	TYPE		LENGTH	MAXIMUM OPENING	☐	AVAILABLE
			EXTERNAL	INTERNAL				
368G	0.070"	0°	•		7"	1-5/8"	1	✓
369G	0.070"	90°	•		7"	1-3/8"	1	✓
366G	0.070"	0°		•	7"	1-1/16"	1	✓
367G	0.070"	90°		•	7"	1-1/16"	1	✓

### FORGED RETAINING RING PLIERS WITH VINYL HANDLES

**MASTER USE**

**SURTEK**  
TOOLS FOR SPECIALISTS



• Meet ASME B107.500 Standard

ITEM	TIP DIAMETER	ANGLE	TYPE		LENGTH	MAXIMUM OPENING	☐	AVAILABLE
			EXTERNAL	INTERNAL				
PFR610	0.071"	0°	•		7-1/16"	1"	1	On Request
PFR600	0.071"	0°		•	7-1/16"	1"	1	On Request
PFR6190	0.071"	90°	•		6-9/32"	1"	1	On Request
PFR6090	0.071"	90°		•	6-9/32"	1"	1	On Request



## RETAINING RING PLIER WITH FIXED TIPS

### RUBBER GRIP HANDLE RETAINING RING PLIERS WITH FIXED TIPS



URREA



• Meet ASME B107.500 Standard

ITEM	TIP DIAMETER	ANGLE	TYPE		LENGTH	MAXIMUM OPENING	☒	AVAILABLE
			EXTERNAL	INTERNAL				
<b>Rubber grip handle retaining ring pliers with fixed tips</b>								
391	0.038"	0°	•		5-9/32"	1-1/2"	3	✓
3914	0.038"	45°	•		5-13/64"	1-1/2"	3	✓
397	0.038"	90°	•		5-1/8"	1-1/2"	3	✓
389	0.038"	0°		•	5-9/32"	1-1/4"	3	✓
398	0.038"	45°		•	5-13/64"	1-1/4"	3	✓
3989	0.038"	90°		•	5-1/8"	1-1/4"	3	✓
<b>Flat nose retaining ring pliers</b>								
251G	-	0°	•	-	10"	1-1/4"	1	✓
250G	-	0°	•	-	8-3/4"	1-1/4"	3	✓

## RUBBER GRIP HANDLE FLUSH CUT PLIERS FOR PLASTIC AND NON-FERROUS MATERIAL

### RUBBER GRIP HANDLE FLUSH CUT PLIERS FOR PLASTIC AND NON-FERROUS MATERIAL



URREA



Designed to make precise cuts of thermoplastic, thermostable, copper, aluminum and bronze materials, among others.



211G

Handles with ergonomic design.



212G

Reinforced joints for optimum performance.



ITEM	TOTAL LENGTH	JAWWIDTH	MAXIMUM OPENING	☒	AVAILABLE
211G	5"	3/4"	21/32"	6	✓
212G	6"	15/16"	25/32"	6	✓

## ELECTRICIAN PLIERS

### COMBINATION PLIER SET



4  
PIECES

URREA



207G



278G



2292G



240G

Content Item	Total length
207G	7-3/4"
278G	8"
2292G	8-3/8"
240G	10"

ITEM	DESCRIPTION	☒	AVAILABLE
J200G	Combination plier set	1	✓

## ELECTRICIAN PLIERS

### BIMATERIAL HANDLE COMPOUND LEVERAGE ELECTRICIAN PLIERS



VIDEO

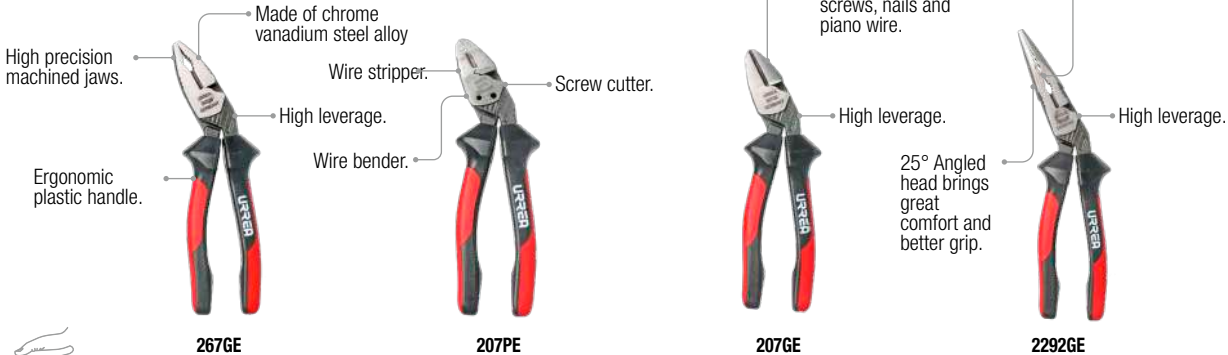

267GE

207PE

207GE

2292GE

• Exceed ASME B107.500 standard.

ITEM	TOTAL LENGTH	MAXIMUM OPENING	HIGH LEVERAGE	CUTS CABLE	WIRE STRIPPER	SCREW CUTTER	CUTTING EDGE TYPE	CUTTING CAPACITY			☞	AVAILABLE
								SOFT WIRE	MEDIUM WIRE	HARD WIRE		
267GE	7-1/2"	1"	✓	✓	-	-	Side	3.5 mm	2.5 mm	2 mm	1	On Request
207PE	7"	31/32"	-	✓	✓	✓	Diagonal cutting	3.5 mm	2.5 mm	2 mm	1	On Request
207GE	7"	7/8"	✓	✓	-	-	Diagonal cutting	3.8 mm	2.7 mm	2.3 mm	1	✓
2292GE	8-2/5"	1-17/32"	✓	✓	-	-	Side	3 mm	2 mm	1.4 mm	1	On Request

### BIMATERIAL HANDLE ELECTRICIAN PLIERS

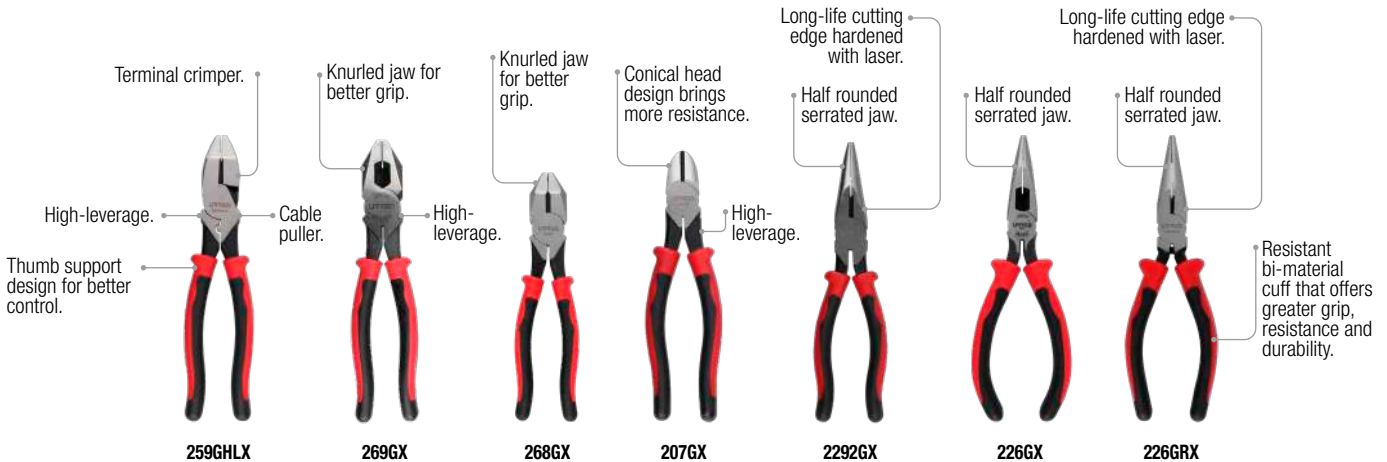

259GHLX

269GX

268GX

207GX

2292GX

226GX

226GRX

• Exceed ASME B107.500 standard.

ITEM	TOTAL LENGTH (A)	JAW WIDTH (B)	JAW THICKNESS (C)	MAXIMUM OPENING (D)	AWG CUTTING CAPACITY	CUTS CABLE	CUTTING EDGE TYPE	CUTTING EDGE	☞	AVAILABLE
259GHLX	9-3/8"	1-29/32"	5/8"	1-9/32"	Cal. 6	✓	Lateral cutting	51/64"	1	On Request
269GX	9-3/8"	2-3/16"	5/8"	1-5/16"	Cal. 6	✓	Lateral cutting	51/64"	1	On Request
268GX	8-21/32"	2"	5/8"	1-7/32"	Cal. 8	✓	Lateral cutting	51/64"	1	On Request
207GX	7-3/4"	1-1/2"	1/2"	31/32"	Cal. 10	✓	Diagonal cutting	1"	1	On Request
2292GX	8-7/16"	2-3/4"	1/2"	1-1/32"	Cal. 8	✓	Lateral cutting	5/8"	1	On Request
226GX	6-23/32"	2-1/4"	3/8"	3/4"	Cal. 10	✓	Lateral cutting	1/2"	1	On Request
226GRX	6-23/32"	2-1/4"	3/8"	3/4"	Cal. 10	✓	Lateral cutting	1/2"	1	On Request

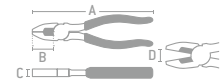

**ELECTRICIAN PLIERS**

**BIMATERIAL HANDLE COMPOUND LEVERAGE ELECTRICIAN PLIERS**

**URREA**  
INDUSTRIAL DUTY



**BIMATERIAL HANDLE** 60% LESS EFFORT

Increases cutting force with 60% less effort compared to standard cutting pliers.

Induction hardened cutting edges.

Induction hardened cutting edges to increase durability.

Half rounded serrated jaw.



**267GCA**

Grips design brings more comfort and control.



**209GCA**



**2292GCA**

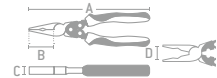

• Exceed ASME B107.500 standard.

ITEM	TOTAL LENGTH (A)	JAW WIDTH (B)	JAW THICKNESS (C)	MAXIMUM OPENING (D)	CUTS CABLE	AWG CUTTING CAPACITY	CUTTING EDGE TYPE	SOFT WIRE MEDIUM	CUTTING CAPACITY MEDIUM WIRE	HARD WIRE	FLAT	⊞	AVAILABLE
<b>267GCA</b>	8"	2"	7/16"	1-3/16"	✓	Cal. 8	Lateral cutting	3 mm	1.6 mm	1.6 mm	2.5 mm	1	On Request
<b>209GCA</b>	7"	2"	7/16"	9/16"	✓	Cal. 8	Diagonal cutting	3 mm	1.6 mm	1.6 mm	2.5 mm	1	On Request
<b>2292GCA</b>	8"	3-1/4"	7/16"	7/8"	✓	Cal. 8	Lateral cutting	3 mm	1.6 mm	1.6 mm	2.5 mm	1	On Request

**BIMATERIAL HANDLE MULTIPURPOSE PLIERS**

**URREA**  
INDUSTRIAL DUTY



**NICKEL-CHROME**

**TPR HANDLE DOUBLE INJECTION**

**SCREW CUTTER**



**258MP**

Wire stripper blades.

Universal tip.

High leverage.

Bi-material handles.



**2292MP**

Ideal to holding, cutting, stripping, screw cutter, and crimping.

Long tip.

High leverage.

Wire crimper.

Diagonal cutting tip.

High leverage.

**207MP**



• Exceed ASME B107.500 standard.

ITEM	TOTAL LENGTH (A)	JAW WIDTH (B)	JAW THICKNESS (C)	MAXIMUM OPENING (D)	CUTS CABLE	AWG CUTTING CAPACITY	SCREW CUTTING CAPACITY	CUTTING EDGE TYPE	CUTTING EDGE	CRIMPER	⊞	AVAILABLE
<b>258MP</b>	8"	1-1/8"	9/64"	1-9/32"	✓	10, 12, 14, 16	6-32; 8-32	Lateral cutting	2.3 mm	✗	1	On Request
<b>2292MP</b>	8"	2-1/2"	9/64"	1-15/16"	✓	10, 12, 14, 16, 18	6-32; 8-32	Lateral cutting	1.6 mm	✗	1	On Request
<b>207MP</b>	7"	1"	7/64"	1"	✓	14, 16	6-32; 8-32	Diagonal cutting	2.0 mm	✓	1	On Request

**RUBBER GRIP HANDLE ELECTRICIAN PLIER**

**URREA**  
INDUSTRIAL DUTY



**RUBBER GRIP**



"Knife and anvil" cutters design ensure proper cutting edge alignment, resulting in a clean cut every time.



Cuts cable ACSR, screws, nails and piano wire.

High leverage.

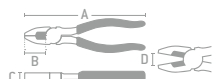

• Exceed ASME B107.500 standard.

ITEM	TOTAL LENGTH (A)	JAW WIDTH (B)	JAW THICKNESS (C)	MAXIMUM OPENING (D)	CUTS CABLE	AWG CUTTING CAPACITY	CUTTING EDGE TYPE	SOFT WIRE MEDIUM	CUTTING CAPACITY MEDIUM WIRE	HARD WIRE	FLAT CABLE	⊞	AVAILABLE
<b>208GM</b>	8"	25/32"	7/16"	7/16"	✓	Cal. 6	Diagonal cutting	4.1 mm	2.2 mm	1.6 mm	2.3 mm	1	✓

## ELECTRICIAN PLIERS

### RUBBER GRIP HANDLE PLIERS

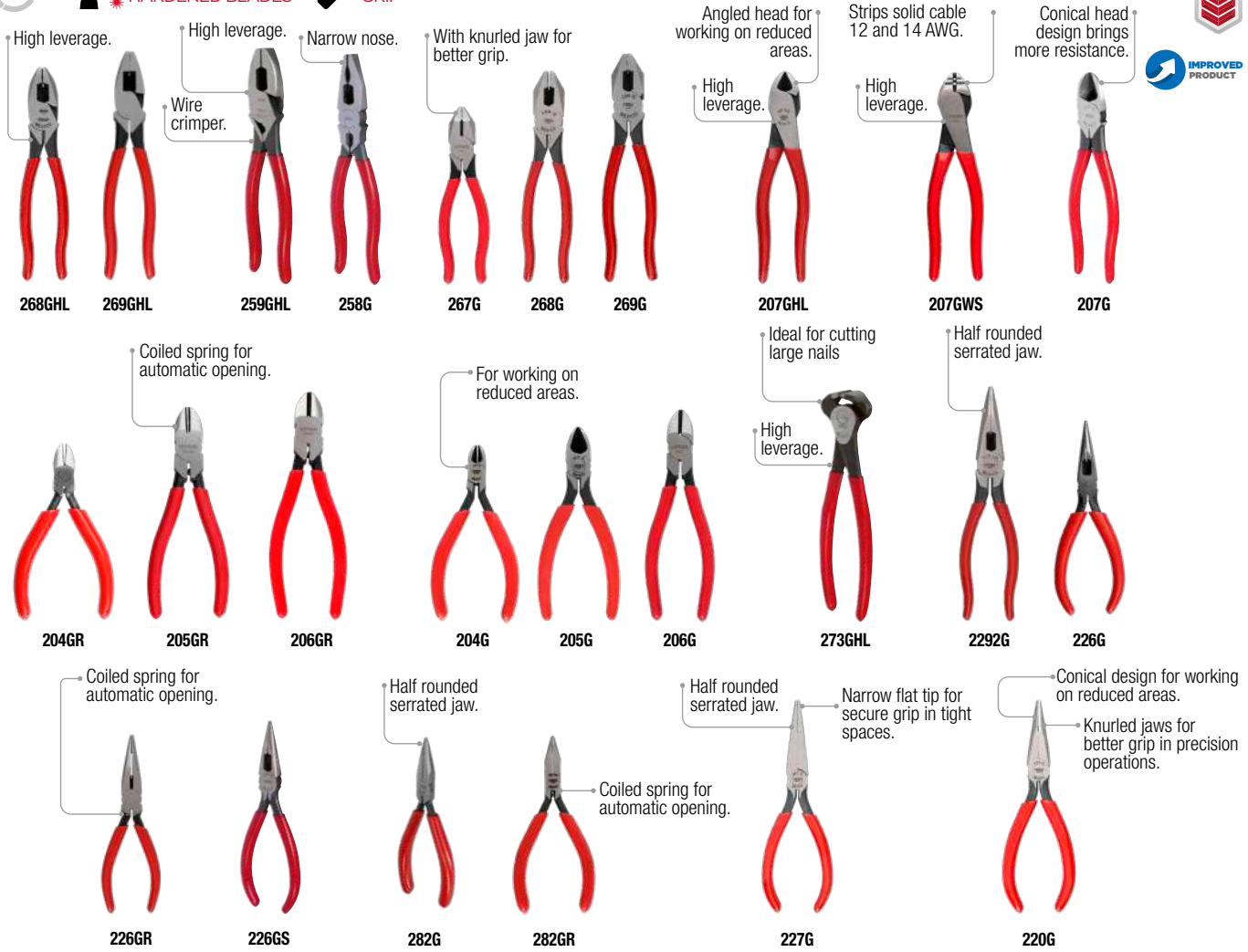

• Exceed ASME B107.500 standard.

ITEM	TOTAL LENGTH (A)	JAW WIDTH (B)	JAW THICKNESS (C)	MAXIMUM OPENING (D)	AWG CUTTING CAPACITY	CUTS CABLE	CUTTING EDGE TYPE	CUTTING EDGE	⚙️	AVAILABLE
268GHL	8-1/2"	1-7/16"	5/8"	1-1/4"	Cal. 8	✓	Lateral cutting	25/32"	3	On Request
269GHL	9"	1-7/16"	5/8"	1-1/4"	Cal. 6	✓	Lateral cutting	25/32"	3	On Request
259GHL	9-5/16"	1-29/32"	5/8"	1-9/32"	Cal. 6	✓	Lateral cutting	25/32"	6	On Request
258G	8-17/32"	2-1/4"	9/16"	1-1/64"	Cal. 8	✓	Lateral cutting	3/4"	3	On Request
267G	7-5/16"	1-3/4"	1/2"	1-3/32"	Cal. 8	✓	Lateral cutting	5/8"	3	On Request
268G	8-17/32"	2"	5/8"	1-7/32"	Cal. 8	✓	Lateral cutting	3/4"	3	On Request
269G	9-5/16"	2-3/16"	5/8"	1-5/16"	Cal. 6	✓	Lateral cutting	13/16"	6	On Request
207GHL	7-15/16"	13/16"	7/16"	1-1/8"	Cal. 10	✓	Diagonal cutting	13/16"	3	On Request
207GWS	7-5/16"	1-5/32"	7/16"	1-5/32"	Cal. 10	✓	Diagonal cutting	13/16"	3	On Request
207G	7-3/4"	1-1/16"	1/2"	1/16"	Cal. 10	✓	Diagonal cutting	1"	6	On Request
204GR	4-3/16"	3/4"	1/4"	27/64"	Cal. 16	✓	Diagonal cutting	1/2"	6	On Request
205GR	5-13/32"	1-3/32"	3/8"	21/32"	Cal. 12	✓	Diagonal cutting	21/32"	6	On Request
206GR	6-1/64"	1-3/32"	7/16"	21/32"	Cal. 12	✓	Diagonal cutting	25/32"	6	On Request
204G	4-3/16"	1/2"	9/32"	27/64"	Cal. 16	✓	Diagonal cutting	1/2"	6	On Request
205G	5-13/32"	1-3/32"	7/16"	21/32"	Cal. 12	✓	Diagonal cutting	3/4"	6	On Request
206G	6-1/64"	1-3/32"	7/16"	21/32"	Cal. 12	✓	Diagonal cutting	3/4"	6	On Request
273GHL	8-3/8"	7/16"	1-3/16"	1-3/4"	Cal. 8	✓	Transversal	1-3/16"	6	On Request
2292G	8-9/32"	2-3/8"	1/2"	1-1/16"	Cal. 8	✓	Lateral cutting	5/8"	6	On Request
226G	6-5/8"	2-1/4"	3/8"	3/4"	Cal. 10	✓	Lateral cutting	1/2"	6	On Request
226GR	6-5/8"	2-1/4"	3/8"	3/4"	Cal. 10	✓	Lateral cutting	1/2"	6	On Request
226GS	6-1/4"	1-29/32"	3/8"	3/4"	Cal. 10	✓	Lateral cutting	1/2"	6	On Request
282G	4-3/4"	1-5/16"	1/4"	27/64"	-	x	-	-	6	On Request
282GR	4-3/4"	1-5/16"	1/4"	27/64"	-	x	-	-	6	On Request
227G	6-5/8"	2-1/4"	3/8"	3/4"	-	x	-	-	6	On Request
220G	6-5/8"	2-1/4"	3/8"	3/4"	-	x	-	-	6	On Request

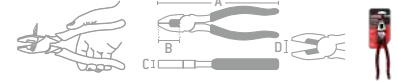

PLIERS, SNIPS AND CUTTERS

**ELECTRICIAN PLIERS**

**EXTRA-LONG PLIERS WITH RUBBER GRIP HANDLE**

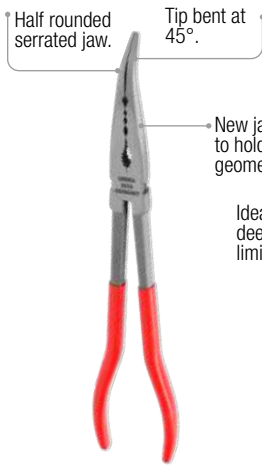

241G

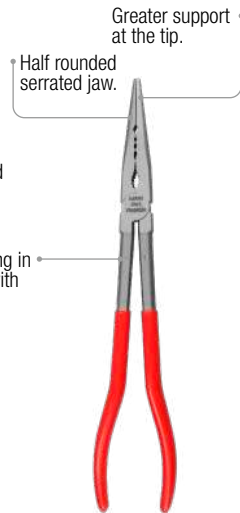

239G

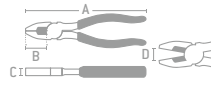

• Exceed ASME B107.500 standard.

ITEM	TOTAL LENGTH (A)	JAW WIDTH (B)	JAW THICKNESS (C)	MAXIMUM OPENING (D)	AWG CUTTING CAPACITY	AVAILABLE
241G	9-5/8"	2-11/16"	3/8"	11/16"	1	On Request
239G	11"	3"	7/16"	5/8"	1	On Request

**EXTRA-LONG PLIERS WITH DOUBLE DIPPED HANDLE**



931

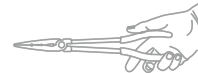

936

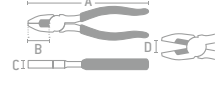

• Meet ASME B107.500 standard.

ITEM	TOTAL LENGTH (A)	JAW WIDTH (B)	JAW THICKNESS (C)	MAXIMUM OPENING (D)	AWG CUTTING CAPACITY	AVAILABLE
931	11"	3"	7/16"	11/16"	1	On Request
936	16"	3-1/2"	15/32"	25/32"	1	On Request

**RUBBER GRIP HANDLE ELECTRICIAN PLIERS**

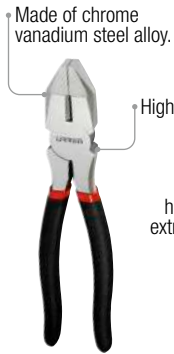

269GI

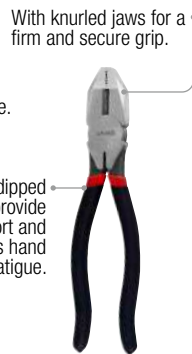

268GI



207GI



2292GI



226GI

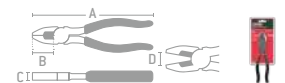

• Exceed ASME B107.500 standard.

ITEM	TOTAL LENGTH (A)	JAW WIDTH (B)	JAW THICKNESS (C)	MAXIMUM OPENING (D)	AWG CUTTING CAPACITY	CUTS CABLE	CUTTING EDGE TYPE	CUTTING EDGE	AWG CUTTING CAPACITY	AVAILABLE
269GI	9"	1-23/32"	21/32"	1-1/32"	Cal. 8	✓	Lateral cutting	15/64"	1	✓
268GI	8-9/16"	1-1/2"	21/32"	1-3/4"	Cal. 10	✓	Lateral cutting	7/32"	1	✓
207GI	7-3/4"	1"	7/16"	59/64"	Cal. 12	✓	Diagonal cutting	11/64"	1	✓
2292GI	8-9/16"	2-5/16"	7/16"	1-1/32"	Cal. 10	✓	Lateral cutting	13/64"	1	✓
226GI	6-3/4"	2"	13/32"	3/4"	Cal. 12	✓	Lateral cutting	5/32"	1	✓

## ELECTRICIAN PLIERS

### RUBBER GRIP HANDLE ELECTRICIAN PLIERS



PLIERS, SNIPS AND CUTTERS



• Meet ASME B107.500 standard.



ITEM	TOTAL LENGTH (A)	JAW WIDTH (B)	JAW THICKNESS (C)	MAXIMUM OPENING (D)	CUTS CABLE	CUTTING EDGE TYPE	CUTTING EDGE	CUTTING CAPACITY	⊞	AVAILABLE
<b>Professional</b>										
979R	9"	1-3/8"	15/32"	1-37/64"	✓	Reinforced lateral cutting	3/4"	Soft and medium	1	On Request
977	7"	1-7/32"	7/16"	1-9/64"	✓	Lateral cutting	5/8"	Soft and medium	1	On Request
978	8"	1-3/8"	17/32"	1-3/8"	✓	Lateral cutting	3/4"	Soft and medium	1	On Request
979	9"	1-1/2"	19/32"	1-1/2"	✓	Lateral cutting	3/4"	Soft and medium	1	On Request
<b>Lateral cutting</b>										
966	6"	1-1/16"	23/64"	43/64"	✓	Lateral cutting	25/64"	Soft and medium	1	On Request
967	7"	1-3/16"	25/64"	1-7/32"	✓	Lateral cutting	15/32"	Soft and medium	1	On Request
968	8"	1-1/2"	25/64"	1-1/2"	✓	Lateral cutting	35/64"	Soft and medium	1	On Request
<b>Diagonal cutting</b>										
945	5"	53/64"	21/64"	43/64"	✓	Diagonal cutting	53/64"	Soft and medium	1	On Request
946	6"	53/64"	23/64"	55/64"	✓	Diagonal cutting	53/64"	Soft and medium	1	On Request
947	7"	63/64"	23/64"	55/64"	✓	Diagonal cutting	29/32"	Soft and medium	1	On Request
<b>Long nose</b>										
925	5"	1-1/2"	23/64"	1-39/64"	✓	Lateral cutting	25/64"	Soft and medium	1	On Request
926	6"	1-49/64"	23/64"	1-11/16"	✓	Lateral cutting	7/16"	Soft and medium	1	On Request
927	7"	2-13/64"	3/8"	1-57/64"	✓	Lateral cutting	15/32"	Soft and medium	1	On Request
929	8"	2-9/32"	25/64"	1-21/32"	✓	Lateral cutting	33/64"	Soft and medium	1	On Request
<b>Slip joint plier</b>										
908	8"	1-3/8"	25/64"	2-23/64"	✗	-	-	Soft and medium	6	✓

## ELECTRONIC PLIERS

### PRECISION PLIER TWEezer SET



**4**  
PIECES

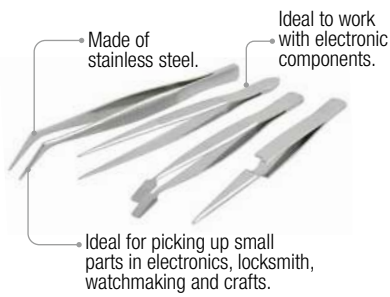

Content	
Straight tip 4-1/2"	1
Curve tip 4-3/4"	1
Flat tip 4-1/4"	1
Cross locking 4-1/2"	1



ITEM	PIECES	⊞	AVAILABLE
115200	4	10	On Request



## ELECTRONIC PLIERS

### RUBBER GRIP HANDLE ELECTRONIC PLIERS



URREA



IMPROVED PRODUCT

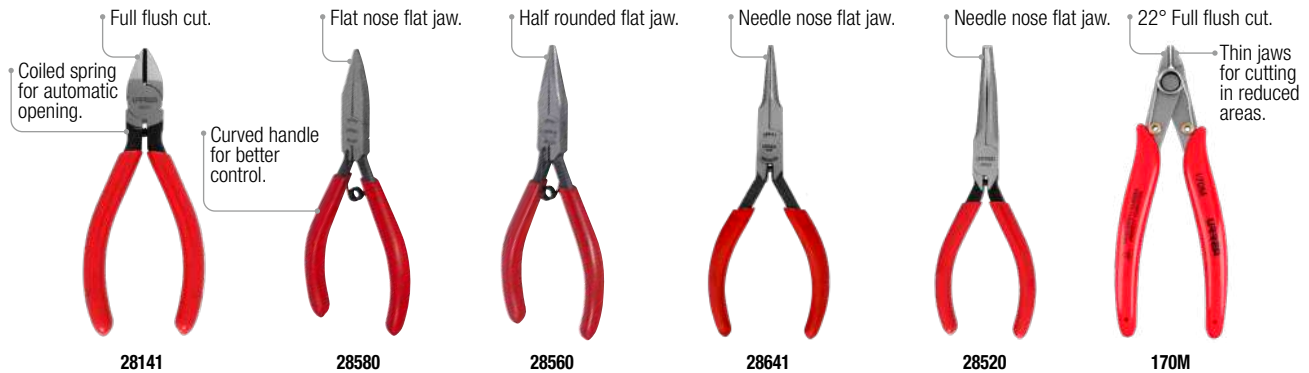

• Exceed ASME B107.500 standard.

ITEM	TOTAL LENGTH (A)	JAW WIDTH (B)	JAW THICKNESS (C)	MAXIMUM OPENING (D)	CUTS CABLE	CUTTING EDGE TYPE	CUTTING EDGE	OPENINGS	AVAILABLE
28140	4-3/16"	3/4"	1/4"	27/64"	✓	Full flush	1/2"	3	On Request
28141	5"	1"	5/16"	9/16"	✓	Full flush	21/32"	3	On Request
28580	4-3/4"	1-5/16"	1/4"	27/64"	✗	-	-	3	On Request
28560	4-3/4"	1-5/16"	1/4"	27/64"	✗	-	-	3	On Request
28641	5-5/8"	2-1/16"	5/16"	9/16"	✗	-	-	3	On Request
28520	5-11/32"	1-29/64"	3/8"	9/16"	✗	-	-	3	On Request
170M	5-1/8"	3/4"	3/16"	5/8"	✓	Full flush	9/16"	6	On Request



### BIMATERIAL HANDLE ESD ELECTRONIC PLIERS



URREA



VIDEO



• Exceed ASME B107.500 standard.

ITEM	TOTAL LENGTH (A)	MAXIMUM OPENING (B)	CUTS CABLE	CUTTING EDGE TYPE	CUTTING CAPACITY		OPENINGS	AVAILABLE
					SOFT WIRE MEDIUM	MEDIUM WIRE		
28140X	4-1/2"	1-1/16"	✓	Diagonal cutting	0.3 - 1.3 mm	0.3 - 1.3 mm	1	✓
28141X	4-1/2"	1-1/16"	✓	Diagonal cutting	0.3 - 1.3 mm	0.3 - 1.3 mm	1	✓
28142X	4-1/2"	1"	✓	Diagonal cutting	0.3 - 1.3 mm	0.3 - 1.3 mm	1	✓
28660X	4-3/4"	1-1/2"	-	-	-	-	1	On Request
28520X	5"	1-1/2"	-	-	-	-	1	✓
28580X	4-3/4"	1-1/2"	-	-	-	-	1	On Request



## ELECTRONIC PLIERS

### ELECTRONICS PLIERS



**28141P**  
Diagonal cut, tapered jaw with spring-loaded handles



**28520P**  
45° offset long nose spring loaded handles

DESCRIPTION	ITEM	TOTAL LENGTH	JAW WIDTH	JAW THICKNESS	MAXIMUM OPENING	CUTTING CAPACITY	CUTS CABLE	CUTTING EDGE TYPE	CUTTING EDGE	CUTTING CAPACITY		AVAILABLE
										SOFT WIRE	MEDIUM WIRE	
Diagonal cutting	<b>28141P</b>	5-1/8"	45/64"	25/64"	5/8"	15 ga.	✓	Full-flush	45/64"	1.5 mm	1 mm	1 On Request
45° offset long nose	<b>28520P</b>	5-7/8"	1-3/4"	25/64"	9/16"	n/a	✗	n/a	21/32"	-	-	1 On Request

### BIMATERIAL HANDLE ELECTRONIC PLIERS



NEW

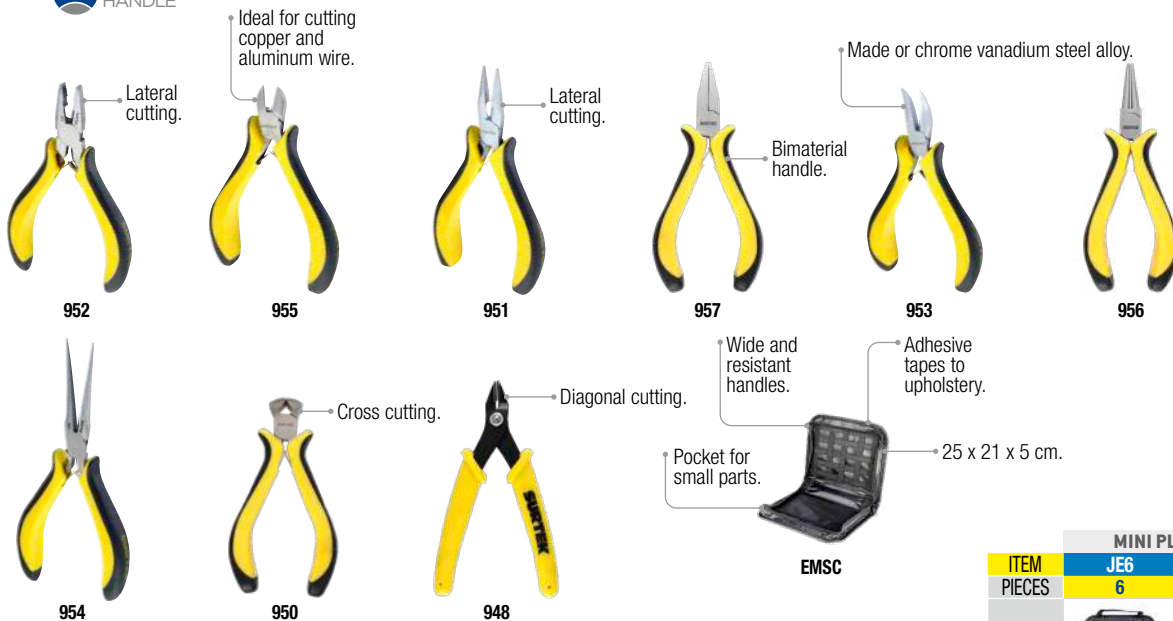

• Exceed ASME B107.500 standard.

ITEM	TOTAL LENGTH (A)	CUTS CABLE	CUTTING EDGE TYPE	CUTTING CAPACITY	AVAILABLE	MINI PLIER SET	
						JE6	95P3
<b>952</b>	4-1/2"	✓	Lateral cutting	Soft wire	12 On Request	•	
<b>955</b>	4-5/16"	✓	Diagonal cutting	Soft wire	12 On Request	•	•
<b>951</b>	4-3/4"	✓	Lateral cutting	Soft wire	12 On Request	•	•
<b>957</b>	4-3/4"	-	-	-	12 On Request	•	
<b>953</b>	4-3/4"	-	-	-	12 On Request	•	
<b>956</b>	4-3/4"	-	-	-	12 On Request	•	•
<b>954</b>	5-7/8"	-	-	-	12 On Request		
<b>950</b>	4-1/16"	✓	Cross cutting	Soft wire	12 On Request		
<b>948</b>	5"	✓	Diagonal cutting	Soft wire	6 On Request		
<b>Small canvas case EMSC</b>	-	-	-	-	1 On Request	•	



**GROOVE JOINT PLIERS**

**URREA**  
CORPORATE INDUSTRIAL DIV.



Flat jaws, can be used on chromed accessories without damaging them.  
Parrot jaws are self-gripping and ideal for use on round surfaces.  
Made of chrome vanadium steel alloy.

**265G**

Tongue and groove pipe plier

Smooth jaws provide a strong grip and protect plated surfaces or soft fasteners (nickel, chrome, PVC) from scratching or marring.  
Made of chrome vanadium steel alloy.

**246G**

Smooth jaw groove joint plier

Self-clamping jaws  
Made of chrome vanadium steel alloy

**274**

7-Position groove joint plier for pipes

Made of chrome vanadium steel alloy.

Special jaw design and ergonomic offset head accommodates many shapes with greater leverage

**263G**

6-Position power grip plier for pipes



Made of chrome vanadium steel alloy.  
Self-clamping jaws  
Rubber grip handle.

**240G**

5-Position groove joint plier

Universal jaw to hold multiple geometries.  
Quick Release system brings smooth and fast adjustments.  
Made of chrome vanadium steel alloy.

**274GI**

Quick release groove joint plier

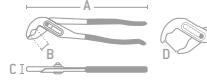

PLIER SET	
ITEM	J201G
PIECES	2
PACKING	
	1

• Exceed ASME B107.500 standard.

ITEM	DESCRIPTION	TOTAL LENGTH (A)	JAW WIDTH (B)	JAW THICKNESS (C)	MAXIMUM OPENING (D)	POSITIONS	AVAILABLE
265G	5-Position groove joint pliers	9-1/2"	1-1/8"	15/32"	1-1/8"	4	✓
266G	Tongue and groove pipe pliers	13-1/2"	1-5/8"	1/2"	2"	6	✓
246G	Tongue and groove pipe pliers	10"	1-3/8"	7/16"	2"	5	✓
274	Smooth jaw groove joint pliers	7"	1-1/16"	1/4"	1-7/64"	7	✓
270	7-Position groove joint pliers for pipes	10"	1-13/32"	9/32"	1-1/4"	7	✓
275	7-Position groove joint pliers for pipes	12"	1-37/64"	23/64"	1-21/32"	7	✓
262G	7-Position groove joint pliers for pipes	6-1/2"	1"	1/4"	1"	5	✓
263G	6-Position power grip pliers for pipes	9-1/2"	1-11/32"	23/64"	1-1/4"	5	✓
264G	6-Position power grip pliers for pipes	12-1/2"	1-25/32"	31/64"	2-1/4"	6	✓
240G	6-Position power grip pliers for pipes	10"	1-9/16"	1/2"	1-1/2"	5	✓
274GI	Quick Release	8"	3/4"	1/4"	2-3/4"	19	On Request
270GI	Quick Release	10"	7/8"	5/16"	3-1/2"	19	On Request

**GROOVE JOINT PLIERS**



**SURTEK**  
TOOLS FOR PROFESSIONALS



Made of chrome vanadium steel alloy.  
Double dipped handle for better grip.



**938**

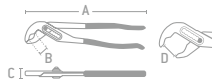

• Exceed ASME B107.500 standard.

ITEM	TOTAL LENGTH (A)	JAW WIDTH (B)	JAW THICKNESS (C)	MAXIMUM OPENING (D)	POSITIONS	AVAILABLE
938	8"	1-1/8"	15/32"	1-3/8"	5	On Request
940	10"	1-3/8"	7/16"	2"	6	On Request
942	12"	1-1/2"	15/32"	2-5/8"	7	On Request

**SAFETY WIRE TWIST PLIERS**

**SAFETY WIRE TWIST PLIERS**



**URREA**  
CORPORATE INDUSTRIAL DIV.



Versatile plier will reliably twist safety wire rapidly and consistently.



For use on safety wire applications found on vehicles, machinery and aircraft.



Reversible action for left and right twists.

ITEM	TYPE	WIRE SUPPORTED	LENGTH	AVAILABLE
190	Lateral cutting	1/16"	8-3/8"	✓
192	Lateral cutting	1/16"	10-1/2"	✓

## FENCING PLIER

### DOUBLE DIPPED HANDLE FENCING PLIER

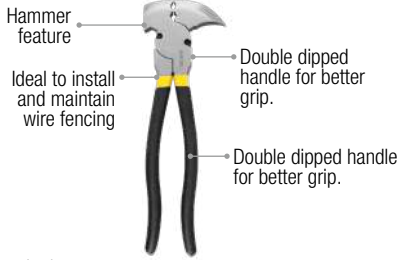

• Exceed ASME B107.500 standard.

ITEM	LENGTH		AVAILABLE
110079	11"	1	On Request



## SLIP JOINT PLIERS

### RUBBER GRIP HANDLE SLIP JOINT PLIERS

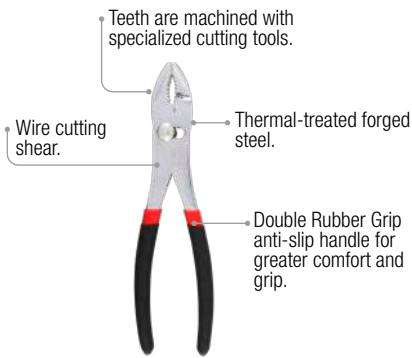

278G

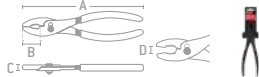
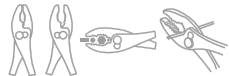

• Exceed ASME B107.500 standard.

ITEM	TOTAL LENGTH (A)	JAW WIDTH (B)	JAW THICKNESS (C)	MAXIMUM OPENING (D)		AVAILABLE
276G	6-3/8"	1-11/16"	13/32"	1-1/8"	6	✓
278G	8"	1-29/32"	13/32"	1-3/16"	6	✓
280G	10"	2-11/32"	1/2"	1-7/16"	6	✓

### CHROME FINISH SLIP JOINT PLIERS

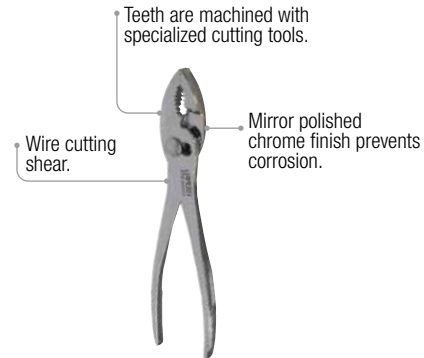

278

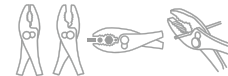

• Exceed ASME B107.500 standard.

ITEM	TOTAL LENGTH (A)	JAW WIDTH (B)	JAW THICKNESS (C)	MAXIMUM OPENING (D)		AVAILABLE
276	6-3/8"	1-11/16"	13/32"	1-1/8"	6	✓
278	8"	1-29/32"	13/32"	1-3/16"	6	✓
280	10"	2-11/32"	1/2"	1-7/16"	6	✓

### RUBBER GRIP HANDLE BLACK SLIP JOINT PLIERS



278B



• Exceed ASME B107.500 standard.

ITEM	TOTAL LENGTH (A)	JAW WIDTH (B)	JAW THICKNESS (C)	MAXIMUM OPENING (D)		AVAILABLE
278B	8"	1-29/32"	13/32"	1-3/16"	1	On Request
280B	10"	2-11/32"	1/2"	1-7/16"	1	On Request

### RUBBER GRIP HANDLE SLIP JOINT PLIERS



906



• Exceeds B107.500 standard.

ITEM	TOTAL LENGTH (A)	JAW WIDTH (B)	JAW THICKNESS (C)	MAXIMUM OPENING (D)		AVAILABLE
906	6"	1-7/32"	23/64"	1-27/32"	6	✓
908	8"	1-3/8"	25/64"	2-23/64"	6	✓
910	10"	1-39/64"	7/16"	2-53/64"	3	✓

**FOLDING MULTI-TOOL**

**FOLDING MULTI-TOOL 16 FUNCTIONS**



**16**  
FUNCTIONS

Functions	
☞ Bottle opener	1
☞ Can opener	1
☞ Long nose plier, curve jaw pliers, wire stripper, wire cutter	4
☞ Knife	1
☞ Phillips® Screwdriver, slotted screwdriver medium and small	3
☞ Reamer	1
☞ Serrated blade	1
☞ File	1
☞ Wire stripper	1
☞ Shackle ring	1
☞ Saw	1



ITEM	MAXIMUM OPENING	OPEN LENGHT	FOLDED LENGHT	☞	AVAILABLE
18566	1-3/8"	7"	4-7/16"	1	On Request



**FOLDING MULTI-TOOL 21 FUNCTIONS**



**21**  
IN ONE

Functions	
☞ Can opener	1
☞ Cable cutter	1
☞ Awl	1
☞ Wire stripper	1
☞ Shock absorber spring	1
☞ Hook remover	1
☞ Punch	1
☞ Peeling	1
☞ Cut cables and wires	2
☞ Knife and serrated knife	2
☞ Big Flat Screwdriver, Middle Flat Screwdriver, Small Flat Screwdriver	4
☞ Bastard file, fine file	3
☞ Curve jaws plier, Straight jaws plier	2



- Made of stainless steel.
- Stainless steel handles.

ITEM	MAXIMUM OPENING	OPEN LENGHT	FOLDED LENGHT	☞	AVAILABLE
120501	1"	6"	4"	1	✓



**WIRE STRIPPING PLIERS**

**AUTOMATIC WIRE STRIPPING PLIER**

**MEGA DUTY** **6-20 AWG GAUGE FILAMENT CABLES** **8-20 AWG GAUGE RIGID CABLES**

**7/64"** CUTTING DIAMETER

Integrated, well-accessible wire cutter up to 3 mm diameter.



ITEM	DESCRIPTION	WEIGHT	LATERAL CUTTING	☞	AVAILABLE
PEC02	Automatic stripper 6-20 AWG	0.5 lb	7/64"	1	✓

**4 IN 1 MULTIFUNCTIONAL WIRE STRIPPER**

**MEGA DUTY** **10-20 AWG GAUGE** **5/16"-1/2"** CUTTING DIAMETER

**4-IN-1** FUNCTIONS

Electrical wire stripper has different size calibers to meet various needs and cable types from (10 - 20 AWG).

Flush stripping, even in hard-to-reach areas.

Safe and space saving storage with closing clip.



ITEM	DESCRIPTION	WEIGHT	MAXIMUM CUTTING DIAMETER	☞	AVAILABLE
PEC03	4-in-1 multifunctional wire stripper	0.18 lb	5/16"-1/2"	1	✓

**AUTOMATIC WIRE STRIPPING PLIER**

**MEGA DUTY** **10-24 AWG GAUGE STRIATED CABLE** **5/64"** CUTTING DIAMETER

Integrated, well-accessible wire cutter up to 2 mm diameter.

Adjusts automatically to the respective cable cross-section, which prevents damage to the conductor.



ITEM	DESCRIPTION	WEIGHT	CORTE LATERAL	☞	AVAILABLE
PEC01	Automatic stripper 10-24 AWG	0.25 lb	5/64"	1	✓

**2 IN 1 MULTIFUNCTIONAL WIRE STRIPPER**

**MEGA DUTY** **10-20 AWG GAUGE** **5/32"-15/16"** CUTTING DIAMETER

Blade fully protected.



ITEM	DESCRIPTION	WEIGHT	MAXIMUM CUTTING DIAMETER	☞	AVAILABLE
PEC05	2-in-1 multifunctional wire stripper	0.14 lb	5/32"-15/16"	1	✓

PLIERS, SNIPS AND CUTTERS

## WIRE STRIPPING PLIERS

### AIR CUSHION HANDLE WIRE STRIPPING PLIERS



299



298



291P



293

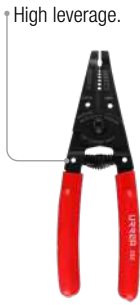

292



297



291



296



- Better cutting capacity and hardness in blades.
- Exceed ASME B107.500 standard.

ITEM	TOTAL LENGTH	STRIPPING CAPACITY (AWG)		SCREW SHEARING						CRIMPS TERMINALS	☐	AVAILABLE
		SOLID	STRIATED									
299	8-3/4"	8, 10, 12, 14, 16, 18	10, 12, 14, 16, 18, 20, 22	10 - 24	6 - 32	8 - 32	10 - 32	4 - 40	-	✓	3	On Request
298	8-1/4"	10, 12, 14, 16, 18, 20, 22	-	10 - 24	6 - 32	8 - 32	10 - 32	4 - 40	5 - 40	✓	3	On Request
291P	7-1/4"	10, 12, 14, 16, 18	12, 14, 16, 18, 20	-	6 - 32	8 - 32	-	-	-	-	3	On Request
293	6"	22, 24, 26, 28, 30	-	-	-	-	-	-	-	-	3	On Request
292	6-3/4"	16, 18, 20, 22, 24, 26	-	-	-	-	-	-	-	-	3	On Request
297	6-3/4"	10, 12, 14, 16, 18, 20	-	-	-	-	-	-	-	-	3	On Request
291	6-3/4"	10, 12, 14, 16, 18, 20	-	-	-	-	-	-	-	-	3	On Request
296	4-29/32"	10 - 20	-	-	-	-	-	-	-	-	3	On Request



### WIRE STRIPPING PLIERS



PLC6



PLC8



PLC9



PLC10

- Exceed ASME B107.500 standard.

ITEM	TOTAL LENGTH	STRIPPING CAPACITY	☐	AVAILABLE
PLC10	10"	10 - 22 AWG	1	On Request
PLC9	9"	10 - 24 AWG	1	On Request
PLC8	8"	10 - 22 AWG	1	On Request
PLC6	6"	10 - 26 AWG	1	On Request



**WIRE STRIPPING PLIERS**

**AUTOMATIC WIRE STRIPPING PLIER**



ITEM	TOTAL LENGTH	STRIPPING CAPACITY SOLID (AWG)	⊞	AVAILABLE
313	6.6"	10, 12, 14, 16, 18, 20, 22	1	✓

Replacement blade for 313

ITEM	DESCRIPTION	⊞	AVAILABLE
R313	Replacement blade	1	✓

**AUTOMATIC WIRE STRIPPING PLIERS**



ITEM	TOTAL LENGTH	STRIPPING CAPACITY SOLID (AWG)	⊞	AVAILABLE
997	7"	8-22	1	On Request



ITEM	TOTAL LENGTH	STRIPPING CAPACITY SOLID (AWG)	⊞	AVAILABLE
993	8"	10-24	1	On Request

**RUBBER GRIP HANDLE CRIMPER PLIER**

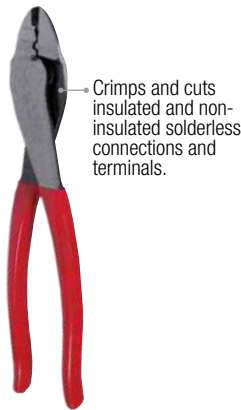

• Exceed ASME B107.500 standard.

ITEM	TOTAL LENGTH	JAW WIDTH	JAW THICKNESS	MAXIMUM OPENING	CRIMPING CAPACITY	⊞	AVAILABLE
208G	9-1/2"	1-5/32"	1/2"	1-5/16"	10-22 AWG	1	✓

**RATCHETING MODULAR CRIMPER/STRIPPER**

**3 IN 1 RATCHETING MODULAR CRIMPER/STRIPPER**



ITEM	CRIMPS CONNECTORS	CONDUCTORS/POSITION	LENGTH	⊞	AVAILABLE
302	RJ22, RJ12/11, RJ45	4 - 6 - 8 - 10	8,3" (210 mm)	1	✓
R302		Replacement blade		1	✓

**3 IN 1 RATCHETING MODULAR CRIMPER/STRIPPER**



ITEM	CRIMPS CONNECTORS	CONDUCTORS/POSITION	LENGTH	⊞	AVAILABLE
303	RJ12/11, RJ45	4 - 6 - 8	7.5" (191 mm)	1	✓
R303		Replacement blade		1	✓

**3 IN 1 RATCHETING MODULAR CRIMPER/STRIPPER**



ITEM	CRIMPS CONNECTORS	CONDUCTORS/POSITION	LENGTH	⊞	AVAILABLE
994	RJ45, RJ12 & RJ9	4 - 6 - 8	8"	1	On Request

PLIERS, SNIPS AND CUTTERS

## RATCHETING MODULAR CRIMPER/STRIPPER

### RATCHETING MODULAR CRIMPER/STRIPPER



RJ45  
8P



Strips, cuts and crimps cable.

For cutting and assembling of RJ45 connectors.

Ergonomic handle.



ITEM	CRIMPS CONNECTORS	CONDUCTORS/POSITION	LENGTH	⊞	AVAILABLE
995	RJ45	8	9"	1	On Request

## COAXIAL CABLE CRIMP TOOL

### COMPRESSION CRIMPER



COAXIAL  
CABLE



Compresses RG59/6 coaxial cables with F, BNC and RCA type connectors.

Includes special adaptor for F-type connectors.

Fixed plunger allows quick, easy insertion and removal of cable and connector.



Connectors				
Connectors	Before (±0.2)		After (±0.2)	
	MIN.	MAX.	MIN.	MAX.
F	24	33.5	15.9	25.2
BNC	36.1	45.7	28	34.4
RCA	36.1	45.7	28	37.4

ITEM	CRIMPS CONNECTORS	LENGTH	⊞	AVAILABLE
304	F - BNC - RCA	6.1" (155 mm)	1	On Request

## FIBER OPTIC STRIPPER

### FIBER OPTIC STRIPPER



High precision blades prevent fiber damage.

Strips first, second and third fiber-optic jacket insulation.



ITEM	CAVITIES FOR	LENGTH	⊞	AVAILABLE
310	2 mm: Outer jack 900 μm: Buffer insulation 250 μm Acrylate coating	6.3" (162 mm)	1	On Request

## IMPACT PUNCHDOWN TOOL



Terminate cable in variety of cross-connect panels, blocks and keystone jacks.

Integrated hook and spudger for fast, easy manipulation of wire and small components.

Offers a quick and easy blade change system.

Blade storage compartment.

Impact intensity regulator (High / Low).



ITEM	DESCRIPTION	BLADE	⊞	AVAILABLE
309	Punchdown tool	66 & 88/110	1	✓
R309A	Replacement blade	66	1	✓
R309B	Replacement blade	66/110	1	✓

## COAXIAL AND UPT/STP CABLE STRIPPER

### COAXIAL AND UPT/STP CABLE STRIPPER



FLAT CABLE ROUND CABLE COAXIAL CABLE



Stripping length 1/2" and 1/4".

Adjustment knob regulates blade height.

Reversible cartridge according coaxial cable diameter.

Large finger loop promotes rotation during use.



ITEM	FOR CABLE	LENGTH	⊞	AVAILABLE
307	RG59/6 - RG7/11 - UTP / STP	4.9" (125 mm)	1	✓
R307	Replacement blade		1	✓

## KEVLAR® CUTTER

### KEVLAR CUTTER



Cuts easily excess fiber Kevlar® and fiber optic cables.

Serrated blade that prevents cable slippage.

Handles made of TPR.

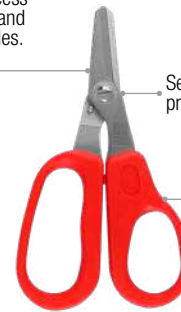

ITEM	LENGTH	⊞	AVAILABLE
312	5.8" (147 mm)	1	✓

**LOCKING PLIERS**

**LOCKING PLIERS**



**URREA**



Holds flat, round shapes and amorphous objects; ideal for plumbing and maintenance.

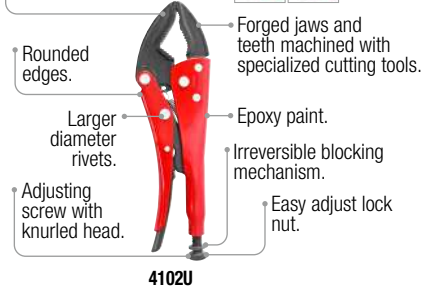

4102U

Using two universal locking pliers you can create a portable vise.



4102UR

With wire cutting jaws.



4073

Curved jaw to hold round and amorphous objects.



4102

Straight jaw to hold flat or square objects.



4071

The solid copper pad on the fixed jaw solves the problem of burn thru when plug welding thin sheet metal panels.



4137

Permits the clamping of adjacent jobs and perfect visibility when welding.



4129

Provides aid when holding, placing or extracting pieces in awkward areas, engines, etc.



4091

Great for bending, forming, and crimping sheet metal without hand gripping effort.



4128

Wraps and fastens irregularly shaped objects easily and quickly.



4120

Chain length 18-7/8".

With swivel pads for holding objects with irregular surfaces.



4118

Multi-purpose tool for maintenance and repair workshops.



4122

Provides an excellent grip on most screw-in oil filters.

Maximum opening 100 mm.



• Exceed ASME B107.500 standard.

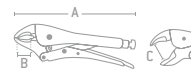

		PLIER SETS			
ITEM		4100B	4100A	4100	4100C
PIECES		5	3	3	2
PACKING					
AVAILABLE		1	1	1	1

ITEM	TOTAL LENGTH (A)	JAW WIDTH (B)	MAXIMUM OPENING (C)	AVAILABLE
<b>Universal locking pliers</b>				
4072U	7-7/8"	1-49/64"	1-37/64"	1 ✓
4102U	9-27/32"	2-11/64"	2-23/64"	1 ✓
4104U	12-13/64"	2-23/64"	2-23/64"	1 ✓
<b>Universal locking plier with plier holder visebench</b>				
4102UR	10"	2-11/64"	2-23/64"	1 ✓
<b>Curved locking pliers with wire cutter</b>				
4073	7-31/64"	1-3/16"	1-21/32"	1 ✓
4103	9-1/4"	1-1/2"	2-23/64"	1 ✓
<b>Curved locking pliers</b>				
4072	7-31/64"	1-3/16"	1-21/32"	1 ✓
4102	9-1/4"	1-1/2"	2-23/64"	1 ✓
<b>Straight locking pliers</b>				
4071	7-31/64"	1-1/2"	1-21/32"	1 ✓
4101	9-1/4"	1-21/32"	2-23/64"	1 ✓
<b>Plugweld Grip Locking Plier</b>				
4137	9-1/2"	3"	1-11/32"	1 ✓
<b>U-Clamp locking plier</b>				
4129	9-1/16"	2-49/64"	1-37/64"	1 ✓
<b>Long nose locking pliers</b>				
4091	6-57/64"	1-31/32"	2-11/64"	1 ✓
4099	9-1/16"	2-9/16"	2-49/64"	1 ✓
<b>Sheet metal clamp</b>				
4128	8-5/64"	1-49/64"	1-49/64"	1 ✓
<b>Chain clamp</b>				
4120	9-27/32"	3-3/4"	6-19/64"	1 ✓
<b>C-clamp with swivel pads</b>				
4116	6-57/64"	1-31/32"	1-31/32"	1 ✓
4111	11-13/16"	3-45/64"	3-5/32"	1 ✓
4118	18-5/16"	10-15/64"	9-29/64"	1 ✓
4124	24-51/64"	16-9/64"	15-3/4"	1 ✓
<b>Pipe or oil filter clamp</b>				
4122	11-13/16"	3-1/4"	3-1/4"	1 ✓

PLIERS, SNIPS AND CUTTERS

## LOCKING PLIERS

### BIMATERIAL HANDLE LOCKING PLIERS



Curved jaw to hold round and amorphous objects.



292WRG

It has a blade to cut annealed wire.

Straight jaw to hold objects flat.



293RG

Hardened teeth allow a grip from different angles.

Nose jaws allow access to narrow and remote places.



PNLB6

Bi-material handles provide better grip and comfort.

One-hand quick release system for detachments.

Flexible jaws to conform to uneven surfaces.



PCB6

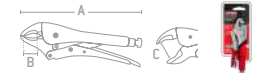

• Exceed ASME B107.500 standard.

ITEM	TOTAL LENGTH (A)	JAW WIDTH (B)	MAXIMUM OPENING (C)	☐	AVAILABLE
<b>Curved locking pliers with wire cutter</b>					
PCUB5	5"	11/16"	15/16"	1	On Request
PCUB7	7"	1"	1-27/64"	1	On Request
292WRG	10"	1-5/32"	2-1/2"	1	On Request
<b>Straight locking plier</b>					
293RG	10"	1-1/8"	2-11/16"	1	On Request
<b>Long nose locking pliers</b>					
PNLB6	6"	1-11/16"	1-57/64"	1	On Request
PNLB9	9"	2-9/32"	2-37/64"	1	On Request
<b>C-clamp with swivel pads</b>					
PCB6	6"	2"	1-55/64"	1	On Request
PCB11	11"	3-3/4"	3-9/64"	1	On Request

### BIMATERIAL HANDLE LOCKING PLIERS



To hold round, curved or amorphous surfaces.



115095

With wire cutter.



• Exceed ASME B107.500 standard.

ITEM	TOTAL LENGTH (A)	JAW WIDTH (B)	MAXIMUM OPENING (C)	☐	AVAILABLE
<b>Curved locking pliers with wire cutter</b>					
115095	10"	5/8"	2"	1	On Request
115096	10"	7/16"	1 3/4"	1	On Request



**LOCKING PLIERS**



Holds flat, round shapes and bulky objects; Ideal for plumbing and maintenance shops.

Powerful curved jaws.

Features a one-hand release system that swiftly unlocks.

Ideal for assembly and welding jobs.

**PU10**

Curved jaw to hold round and amorphous objects

It has a blade to cut annealed wire.

**292WR**

Straight jaw to hold objects flat.

**PR12**

It allows the grip of adjacent pieces and good visibility in welding work.

**261R**

They allow access to narrow and remote places.

**286LN**

Tip designed to firmly grip thin materials such as sheet metal.

**260R**

Flexible jaws to conform to uneven surfaces.

**266R**

Flexible jaws to conform to uneven surfaces.

**PC11**



• Exceed ASME B107.500 standard.

ITEM	TOTAL LENGTH (A)	JAW WIDTH (B)	MAXIMUM OPENING (C)	AVAILABLE	PLIER SET
<b>Universal locking plier</b>					
PU10	10"	2"	2-37/64"	1	<b>2700LP</b>
<b>Curved jaw locking pliers with wire cutter</b>					
PCU4	4"	5/8"	1"	1	<b>4</b>
293WR	5"	3/4"	1-3/8"	1	•
294WR	7"	63/64"	1-3/16"	1	•
292WR	10"	1-5/32"	1-9/16"	1	•
PCU12	12"	1-1/4"	2-5/32"	1	•
<b>Straight locking pliers</b>					
291R	7-1/2"	63/64"	2-7/32"	1	•
293R	10"	1-7/32"	2-19/32"	1	•
PR12	12"	1-1/4"	2-5/32"	1	•
<b>U-Clamp locking plier</b>					
261R	8-7/8"	3"	2-1/2"	1	•
<b>Long nose locking pliers</b>					
PNL4	4"	1-3/8"	1-31/64"	1	•
286LN	6-1/2"	1-3/4"	1-1/2"	1	•
289LN	10"	2-1/4"	2"	1	•
<b>Sheet metal clamp</b>					
260R	8"	3"	2-1/2"	1	•
<b>C-clamp with swivel pads</b>					
PCA6	6"	1-1/2"	2"	1	•
266R	11"	4-7/8"	5-1/4"	1	•
PCA18	18"	8-15/16"	6-31/64"	1	•
<b>C-clamp with fixed tips</b>					
PC6	6"	1-1/8"	2"	1	•
PC11	11"	2-1/8"	3-3/8"	1	•
PC18	18"	9-3/8"	6-31/64"	1	•

ITEM	PLIER SET
ITEM	<b>2700LP</b>
PIECES	<b>4</b>
PACKING	
☐	1
AVAILABLE	<b>On Request</b>

PLIERS, SNIPS AND CUTTERS

## LOCKING PLIERS

### LOCKING PLIERS

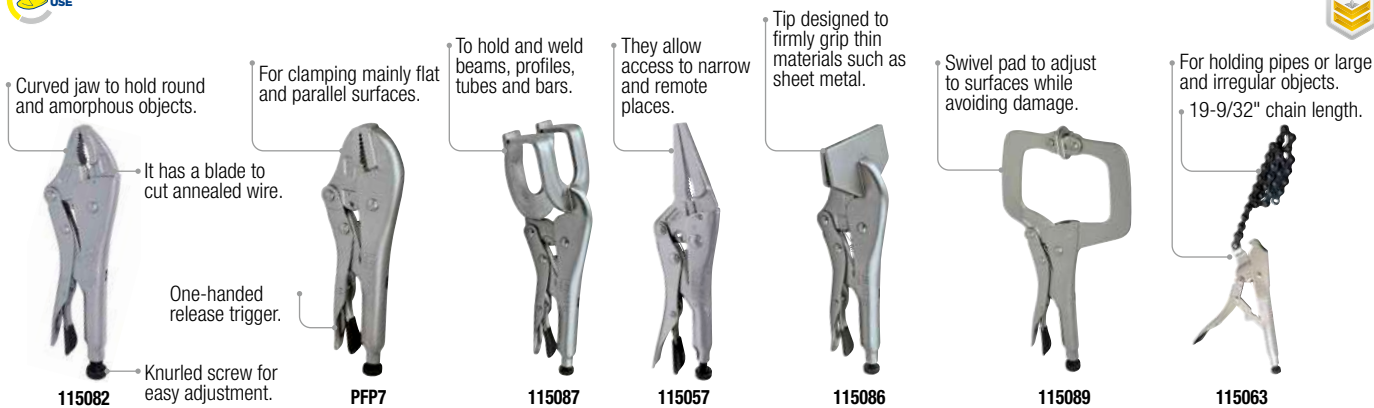

• Exceed ASME B107.500 standard.

ITEM	TOTAL LENGTH (A)	JAW WIDTH (B)	MAXIMUM OPENING (C)	AVAILABLE
<b>Curved locking pliers with wire cutter</b>				
115054	4"	1/4"	7/8"	1 On Request
115084	5"	5/16"	1"	1 On Request
115083	7"	5/16"	1-1/2"	1 On Request
115082	10"	5/16"	1-7/8"	1 On Request
115055	12"	9/16"	1-5/8"	1 On Request
<b>Straight locking pliers</b>				
PFP7	7"	5/16"	1-1/2"	1 On Request
PFP10	10"	7/16"	1-7/8"	1 On Request
PFP12	12"	5/8"	1-1/4"	1 On Request
<b>U-Clamp</b>				
115087	9"	2 3/4"	2"	1 On Request
<b>Long nose locking pliers</b>				
115057	6"	6"	2"	1 On Request
115058	9"	5/16"	2"	1 On Request
<b>Sheet metal clamp</b>				
115086	8"	3-1/4"	1-1/2"	1 On Request
<b>C-clamp with swivel pads</b>				
115089	11"	1"	3"	1 On Request
<b>Chain clamp</b>				
115063	8"	1/2"	1-1/2"	1 On Request

**URREA**  
SUPERIOR QUALITY AFFORDABLE TOOLS



usa.urrea.com

**HALF CUT PINCERS**

**HALF CUT PINCERS**



For twisting and cutting hard cables in a single action.



115129

Made of high carbon steel alloy.

Spring loaded for easy opening.



115118

With tungsten carbide tooth.

Non-slip vinyl coated handle.

For twisting and cutting hard cables in a single action

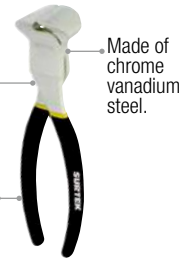

115117

Made of chrome vanadium steel.

Double coating handle.

Double coating on the handle.

Ideal for cutting and twisting wire, and for pulling nails from wood.



115116

• Exceed ASME B107.600 standard.

ITEM	LENGTH	⊞	AVAILABLE
<b>Half cutting pincer</b>			
115129	9"	6	✓



ITEM	LENGTH	⊞	AVAILABLE
<b>Tile nipper</b>			
115118	8-1/2"	6	On Request



ITEM	LENGTH	⊞	AVAILABLE
<b>End cutting pincer</b>			
115117	8"	6	On Request



ITEM	LENGTH	⊞	AVAILABLE
<b>Carpenter's pincer</b>			
115116	8"	6	On Request

**CABLE AND WIRE CUTTERS**

**CABLE AND WIRE CUTTERS**



High-leverage system.



287G

Steel cable and wire cutter

Thumb protector.

Ideal for cutting copper wires from batteries.



289G

AWG 1/0 cooper cable cutter

Ideal for cutting copper wires from batteries.



288G

AWG 1/0 cooper cable cutter



ITEM	TOTAL LENGTH	JAW LENGTH	JAW THICKNESS	MAXIMUM OPENING	⊞	AVAILABLE
287G	9"	3/16"	—	7/16"	1	On Request
289G	9-1/4"	1-5/8"	1-1/2"	—	1	On Request
288G	7-1/2"	1-3/4"	1-1/8"	—	1	On Request

**AVIATION TIN SNIPS**

**RUBBER GRIP HANDLE MULTI-PURPOSE AVIATION SNIPS**



For cutting metal sheet, vinyl, plastic, rubber and many other materials.

They cut up to 20 gauge steel sheets.

Lock keeps snips closed for safe storage.



Aviation snip straight

Compound action multiplies the force of your hand.

Raised guard on handles for hand protection.



CÓDIGO	CUT	WORKING ANGLE	CUTTING EDGE	COOPER	CUTTING CAPACITY STEEL	STAINLESS STEEL	TOTAL LENGTH	LENGTH CUT	⊞	AVAILABLE
303U	Straight		Serrated	—	Gauge 20	—	10"	1-3/4"	3	On Request

## AVIATION TIN SNIPS

### RUBBER GRIP HANDLE AVIATION TIN SNIPS



For cutting metal sheet, vinyl, plastic, rubber and many other materials.

Anti-slip jaws.

Blades are hot drop-forged of molybdenum alloy steel and austempered heat-treated to provide unequalled strength, longest lasting edge life, and the most precise cutting action.

Compound action results in maximum jaw power with minimum effort.

Locking latch prevents damage to cutting edge when stored.



**303S**  
Aviation tin snip straight



**303R**  
Aviation tin snip right



**303L**  
Aviation tin snip left



**303B**  
Universal bulldog aviation



**303RS**  
Offset aviation tin snips 15° right



**303LS**  
Offset aviation tin snips 15° left

Ideal for the metal shear industry.



PLIER SET	
ITEM	<b>30301</b>
PIECES	<b>3</b>
PACKING	
	1
AVAILABLE	✓
	On Request
	On Request

ITEM	CUT	WORK ANGLE	HANDLE COLOR	CUTTING CAPACITY			TOTAL LENGTH	LENGTH CUT		AVAILABLE
303S	Straight		Yellow	Gauge 16	Gauge 18	Gauge 22	10"	1-3/4"	3	On Request
303R	Right		Green	Gauge 16	Gauge 18	Gauge 22	10"	1-5/8"	3	On Request
303L	Left		Red	Gauge 16	Gauge 18	Gauge 22	10"	1-5/8"	3	✓
303B			Yellow	Gauge 16	Gauge 18	Gauge 22	9-1/2"	1"	3	✓
303RS	Right		Green	Gauge 16	Gauge 18	Gauge 22	10"	1-5/8"	3	✓
303LS	Left		Red	Gauge 16	Gauge 18	Gauge 22	10"	1-5/8"	3	✓

### AVIATION TYPE TIN SNIPS



Locking latch allows opening and closing with one hand.

Knurled edges that provide a better grip.

Anti-slip jaws

Bimaterial handle for better grip



**11511**  
Aviation tin snip right



**11510**  
Aviation tin snip left



**11512**  
Aviation tin snip straight



PLIER SET	
ITEM	<b>115115</b>
PIECES	<b>3</b>
PACKING	
	1
AVAILABLE	On Request
	•
	•
	•

ITEM	CUT	WORK ANGLE	HANDLE COLOR	CUTTING CAPACITY			TOTAL LENGTH	LENGTH CUT		AVAILABLE
11511	Right		Green	Gauge 16	Gauge 18	Gauge 20	10"	1-5/8"	6	On Request
11510	Left		Red	Gauge 16	Gauge 18	Gauge 20	10"	1-5/8"	6	On Request
11512	Straight		Yellow	Gauge 16	Gauge 18	Gauge 20	10"	1-5/8"	6	On Request

### RUBBER GRIP HANDLE TIN SNIPS



Snip tool cuts up to 20-gauge cold-roll steel and 22-gauge stainless-steel.

Hot, drop-forged steel blades provide maximum strength and long life.

Rubber grip handles for better performance.



**320G**



**322G**



**324G**



### RUBBER GRIP HANDLE TIN SNIPS



Made of carbon steel.

Satin coating to prevent corrosion.

Handles with non-slip textured rubber cover.

Made of carbon steel.

Ideal for angled cuts in sheet and metal.



**TJH7**



**TJH10A**  
Angled



ITEM	TOTAL LENGTH	LENGTH CUT		AVAILABLE	ITEM	TOTAL LENGTH	LENGTH CUT		AVAILABLE
320G	10"	1-3/4"	1	On Request	TJH7	7"	1-7/8"	4	On Request
322G	12"	2-1/2"	1	On Request	T00	8"	2-1/8"	4	On Request
324G	14"	4"	1	On Request	T01	10"	2-5/8"	4	On Request
					TJH10A	10"	2-5/8"	4	On Request





CLASS	TYPE	PAGE	BRAND	
			URREA	SURTEK
Bars	Impact curved pry bars	308	•	
	Alignment bars	308	•	
	Hex bars	308	•	•
Chisels	Drift pins, punches and chisels set	309	•	•
	Cold cut chisels	311	•	•
	Cape chisels	313	•	
	Chisel holders	313	•	
Punches and points	Punch set	313	•	
	Brass tapered drift punches	313	•	
	Tapered drift punches	313	•	
	Tapered drift punches with grip	314	•	
	Straight pin punches with grip	314	•	
	Straight drift pin punches	314	•	•
	Center and prick punches	315	•	•
	Striking letters a-z	316	•	
Wedges	Concrete chisel hexagonal steel body	316		•
Sledge hammers	Rubber grip handle sledge hammers	316	•	•
	Fiberglass handle sledge hammers	317	•	•
	Wooden handle sledge hammers	317	•	•
	Bronze hammers	318	•	
	Non-slip handle dead blow impact sledge hammers	318	•	
Hammers	Ball pein hammers	319	•	•
	Face hammers	320	•	
	Claw hammers	321	•	•
	Specialty hammers	321	•	•
Mallets	Mallets	323	•	•
Hook and pick set	Scraper hook and pick set	323	•	
Knockout punches	Hollow punches	324	•	

[usa.urrea.com](http://usa.urrea.com)

We are constantly improving our products, that is why the information, characteristics and availability of them can change without prior notice.



## BARs

### BIMATERIAL HANDLE IMPACT CURVED TIP BARS



Impact sleeve integrated with the bar, allowing safe hammer strikes without damaging the handle.

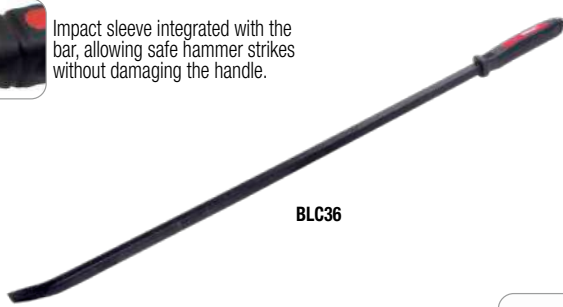

BLC36



- Ideal for lifting and moving heavy objects during maintenance tasks, tool changes, or machinery relocation.
- Made of high-quality micro-alloyed steel.
- Black oxide finish.
- Exceeds ASME B107.33M standard.



Square bar with curved tip

**BULK**

ITEM	LENGTH	BAR SIZE	☐	AVAILABLE
BLC12	12"	3/8"	1	✓
BLC17	17"	3/8"	1	✓
BLC25	25"	1/2"	1	✓
BLC36	36"	5/8"	1	✓
BLC48	48"	3/4"	1	✓

### ALIGNMENT BARS



- Ideal for aligning, adjusting, moving, or disassembling metal or wooden parts.
- The angled chisel-shaped tip provides greater leverage, while the other end allows for object alignment.
- Made of high-quality micro-alloyed steel.
- Black oxide finish.
- Exceeds ASME B107.410 standard.

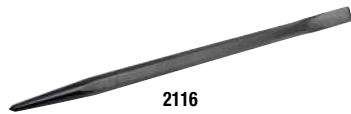

2116

**BULK**

ITEM	DIAMETER	TOTAL LENGTH	☐	AVAILABLE
2116	1/2"	14"	1	✓
2120	5/8"	16"	1	✓
2124	3/4"	24"	1	✓
2125	7/8"	30"	1	✓

### HEX BARS

#### HEX BARS WITH GRIP



Tip Chisel



2840HD

Vulcanized handle for better grip.

- Diamond-shaped tip to facilitate concrete breaking.
- Heat-treated chisel and tip for superior hardness and performance.
- Made of high-quality micro-alloyed steel.
- Exceeds ASME B107.410 standard.

**BULK**

ITEM	DIAMETER	LENGTH	CHISEL	WEIGHT	☐	AVAILABLE
2840HD	1"	59"	2-31/64"	13 lb	1	✓
2850HD	1"	68"	2-31/64"	16 lb	1	✓
2860HD	1-1/4"	68"	3-15/32"	25 lb	1	✓

### ALIGNMENT BAR SET



**3 PIECES**



- Made of high-quality micro-alloyed steel.
- Black oxide finish.
- Exceeds ASME B107.410 standard.

Item	Distance between hexagonal planes
2116	1/2"
2120	5/8"
2126	1/2"

**BULK**

ITEM	PIECES	☐	AVAILABLE
21003	3	1	✓

### LADYFOOT PRY BAR CURVE FORGED HEAD



Special claw design to apply greater torque than traditional alignment bars



2116HD

Forged head.

- Ideal for aligning, adjusting, moving, or disassembling metal or wooden parts.
- Made of high-quality micro-alloyed steel.
- Black oxide finish.
- Exceeds ASME B107.410 standard.

**BULK**

ITEM	LENGTH	☐	AVAILABLE
2116HD	12"	1	✓
2130HD	16"	1	✓

### ALIGNMENT PRY BARS WITH TURNING HEAD



- Ideal for aligning, adjusting, moving, or disassembling metal or wooden parts.
- The angled chisel-shaped tip provides greater leverage, while the other end allows for object alignment.
- Made of high-quality micro-alloyed steel.
- Black oxide finish.
- Exceeds ASME B107.410 standard.



2126

**BULK**

ITEM	DIAMETER	TOTAL LENGTH	☐	AVAILABLE
2126	1/2"	16"	1	✓
2130	5/8"	18"	1	✓

### HEX BARS WITH GRIP

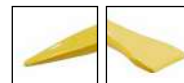

Tip Chisel

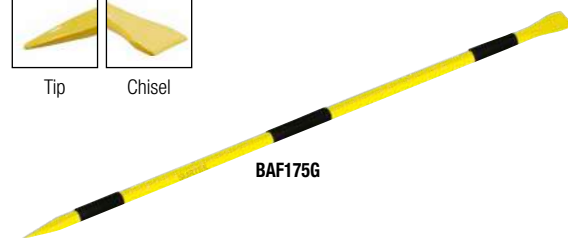

BAF175G

- Heat-treated chisel and tip for superior hardness and performance.
- Made of high-carbon steel.
- Complies with ASME B107.410 standard.

**BULK**

ITEM	DIAMETER	LENGTH	CHISEL	WEIGHT	☐	AVAILABLE
BAF150G	1"	59"	2"	2.9 lb	1	✓
BAF175G	1"	68.8"	2"	3.4 lb	1	✓

**HEX BARS**

**HEX BARS**



Tip Chisel



2840

- Heat-treated chisel and tip for superior hardness and performance.
- Made of high-carbon steel.
- Complies with ASME B107.410 standard.



**BULK**

ITEM	DIAMETER	LENGTH	CHISEL	WEIGHT	⊞	AVAILABLE
2840	1"	59"	13.8"	7 lb	1	✓
2850	1"	68"	16.3"	16 lb	1	✓
2860	1-1/4"	68"	25.1"	25 lb	1	✓

**GOOSENECK WRECKING BARS**



BU75

- Heat-treated claw and tip for enhanced hardness and durability.
- Made of high-carbon steel.
- Complies with ASME B107.410 standard.



**BULK**

ITEM	DIAMETER	LENGTH	WEIGHT	⊞	AVAILABLE
BU45	5/8"	17.7"	1.9 lb	3	On Request
BU60	3/4"	23.6"	3.5 lb	3	On Request
BU75	3/4"	29.5"	4.4 lb	3	On Request
BU90	3/4"	35"	5 lb	3	On Request

**HEX BARS**

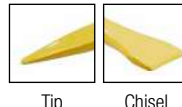

Tip Chisel



BAF175

- Heat-treated chisel and tip for superior hardness and performance.
- Made of high-carbon steel.
- Complies with ASME B107.410 standard.

**BULK**

ITEM	DIAMETER	LENGTH	CHISEL	WEIGHT	⊞	AVAILABLE
BAF100	7/8"	39"	1.5"	7 lb	3	✓
BAF125	7/8"	49.2"	1.5"	9 lb	3	✓
BAF150	1"	59"	2"	13.8 lb	3	✓
BAF175	1"	68.8"	2"	16.3 kg	3	✓
BAF200	1-1/4"	68.8"	2.4"	26.4 lb	3	✓



usa.urrea.com

STRIKING AND STRUCK TOOLS

**DRIFT PINS, PUNCHES AND CHISELS SET**

**DRIFT PINS, PUNCHES, AND CHISELS SET**



**26**  
PIECES

Item	Size	Item	Size
41-3/8	3/8 x 1/8"	50-1/2	1/2 x 1/4"
41-1/2	1/2 x 3/16"	86A-3/16	1/4 x 3/16"
44-5/16	5/16 x 7/64"	86A-1/4	1/4 x 1/4"
47-1/4X3/32	1/4 x 3/32"	86A-5/16	5/16 x 5/16"
47-5/16X1/8	5/16 x 1/8"	86A-7/16	7/16 x 7/16"
47-5/16X5/32	5/16 x 5/32"	86A-1/2	1/2 x 1/2"
47-3/8X3/16	3/8 x 3/16"	86A-5/8	5/8 x 5/8"
47-7/16X7/32	7/16 x 7/32"	86A-3/4X8	3/4 x 3/4"
47-1/2X1/4	1/2 x 1/4"	86A-7/8X8	7/8 x 1"
50-1/4	1/4 x 3/32"	86A-1X8	1 x 3/16"
50-5/16	5/16 x 1/8"	96-5/16	5/16 x 1/8"
50-3/8	3/8 x 3/16"	96-3/8	3/8 x 3/16"
50-7/16	7/16 x 7/32"	96-1/2	1/2 x 1/4"
		E516	Estuche



- Made of chrome vanadium steel.
- Heat-treated for high performance.
- Chamfered striking end to minimize chip formation.
- Exceeds ASME B107.410 standard.

**POUCH**

ITEM	PIECES	⊞	AVAILABLE
NO.46	26	1	✓

**DRIFT PINS AND PUNCHES SET**



**16**  
PIECES

Item	Size	Item	Size
47-1/4X3/32	1/4 x 3/32"	96-3/8	3/8 x 3/16"
47-5/16X1/8	5/16 x 1/8"	96-1/2	1/2 x 1/4"
47-5/16X5/32	5/16 x 5/32"		
47-3/8X3/16	3/8 x 3/16"	41-3/8	3/8 x 1/8"
47-1/2X1/4	1/2 x 1/4"	41-1/2	1/2 x 3/16"
50-1/4	1/4 x 1/16"	44-3/8	3/8 x 5/32"
50-1/4	1/4 x 3/32"	E514	Estuche
50-5/16	5/16 x 1/8"		
50-3/8	3/8 x 3/16"		
50-7/16	7/16 x 7/32"		
50-1/2	1/2 x 1/4"		



- Made of chrome vanadium steel.
- Heat-treated for high performance.
- Chamfered striking end to minimize chip formation.
- Exceeds ASME B107.410 standard.

**POUCH**

ITEM	PIECES	⊞	AVAILABLE
NO.6	16	1	✓

## DRIFT PINS, PUNCHES AND CHISELS SET WITH POUCH

### DRIFT PINS, PUNCHES AND CHISELS SET

**HEAVY DUTY** **BLACK OXIDE FINISH** **CHROME-VANADIUM**

Item	Size	Item	Size
47-1/4X3/32	1/4 x 3/32"	41-3/8	3/8 x 1/8"
47-5/16X1/8	5/16 x 1/8"	86A-3/16	1/4 x 3/16"
47-5/16X5/32	5/16 x 5/32"	86A-5/16	5/16 x 5/16"
47-3/8X3/16	3/8 x 3/16"	86A-7/16	7/16 x 7/16"
50-5/16	5/16 x 1/8"	86A-1/2	1/2 x 1/2"
50-3/8	3/8 x 3/16"	E519	Pouch
96-3/4	3/4 x 3/8"		



**POUCH**

- Made of chrome vanadium steel.
- Heat-treated for high performance.
- Chamfered striking end to minimize chip formation.
- Exceeds ASME B107.410 standard.

ITEM	PIECES	AVAILABLE
NO.5	12	1 ✓

### CHISELS, DRIFT PINS AND PUNCHES SET

**HEAVY DUTY** **BLACK OXIDE FINISH** **CHROME-VANADIUM**

Item	Size	Item	Size
41-3/8	3/8 x 1/8"	86A-1/4	1/4 x 1/4"
47-1/4X3/32	1/4 x 3/32"	86A-3/8	3/8 x 3/8"
47-5/16X1/8	5/16 x 1/8"	86A-7/16	7/16 x 7/16"
47-3/8X3/16	3/8 x 3/16"	E307	Pouch
50-3/16	1/4 x 1/16"		
50-5/16	5/16 x 1/8"		
50-3/8	3/8 x 3/16"		



**POUCH**

- Made of chrome vanadium steel.
- Heat-treated for high performance.
- Chamfered striking end to minimize chip formation.
- Exceeds ASME B107.410 standard.

ITEM	PIECES	AVAILABLE
NO.2	10	1 ✓

### CHISELS, DRIFT PINS AND PUNCHES SET

**HEAVY DUTY** **BLACK OXIDE FINISH** **CHROME-VANADIUM**

Item	Size	Item	Size
47-5/16X5/32	5/16 x 5/32"	86A-7/16	7/16 x 7/16"
50-3/8	3/8 x 3/16"	86A-1/2	1/2 x 1/2"
41-3/8	3/8 x 1/8"	E518	Pouch



**POUCH**

- Made of chrome vanadium steel.
- Heat-treated for high performance.
- Chamfered striking end to minimize chip formation.
- Exceeds ASME B107.410 standard.

ITEM	PIECES	AVAILABLE
NO.4	5	1 ✓

### CHISELS, DRIFT PINS AND PUNCHES SET

**HEAVY DUTY** **BLACK OXIDE FINISH** **CHROME-VANADIUM**

Item	Size	Item	Size
41-3/8	3/8 x 1/8"	50-5/16	5/16 x 1/8"
47-5/16X1/8	5/16 x 1/8"	86A-1/2	1/2 x 1/2"
47-3/8X3/16	3/8 x 3/16"	E300	Pouch



**POUCH**

- Made of chrome vanadium steel.
- Heat-treated for high performance.
- Chamfered striking end to minimize chip formation.
- Exceeds ASME B107.410 standard.

ITEM	PIECES	AVAILABLE
NO.3	5	1 ✓

### CHISELS, DRIFT PINS AND PUNCHES SET

**PROFESSIONAL USE** **ZINC PHOSPHATE FINISH** **CHROME-VANADIUM**

Item	Size
117102	1/4" x 5"
117106	3/8" x 6"
117114	1/2" x 6"
117124	5/8" x 8"
117148	1/8" x 6"
117150	3/16" x 6"
117152	1/4" x 6"
117164	3/8" x 5"
117170	3/8" x 5"



**POUCH**

- Made of high-carbon steel.
- Complies with ASME B107.410 standard.

ITEM	PIECES	AVAILABLE
117194	9	1 On Request

### DRIFT PINS, PUNCHES, AND CHISELS SET

#### POINT, PIN, CHISEL AND PUNCH SET

**INDUSTRIAL DUTY** **ZINC PHOSPHATE FINISH** **CHROME-VANADIUM**

Content	Length	Tip size	Hexagon
<b>Straight pin punches</b>			
	5"	5/32"	5/16"
	4-1/2"	1/8"	5/16"
	5"	3/16"	3/8"
	5-1/2"	1/4"	3/8"
<b>Tapered drift punch</b>	7"	5/32"	3/8"
<b>Prick punch</b>	7"	5/32"	3/8"
<b>Content</b>	<b>Length</b>	<b>Tip size</b>	<b>Hexagon</b>
	4-1/2"	3/16"	3/8"
<b>Punches</b>			
	4"	1/16"	3/8"
	4"	1/8"	3/8"
<b>Cold cut chisels</b>			
	4"	1/4"	1/4"
	5"	3/8"	5/16"
	6"	5/8"	1/2"



**NEW**

- Made of chrome vanadium steel.
- Chamfered striking end to minimize chip formation.
- Exceeds ASME B107.410 standard.

ITEM	PIECES	AVAILABLE
NO.8	12	1 On Request

### CHISEL AND PUNCH SET

**INDUSTRIAL DUTY** **ZINC PHOSPHATE FINISH** **CHROME-VANADIUM**

Content	Length	Tip size	Hexagon
<b>Straight pin punches</b>			
	4"	3-32"	1/4"
	4-1/2"	1/8"	5/16"
<b>Cold cut chisels</b>			
	5-3/4"	1/2"	7/16"
	6-3/4"	3/4"	5/8"
<b>Content</b>	<b>Length</b>	<b>Tip size</b>	<b>Hexagon</b>
	9"	3/16"	1/2"
<b>Tapered pin punches</b>			
	4-1/2"	3/16"	3/8"



**NEW**

- Made of chrome vanadium steel.
- Chamfered striking end to minimize chip formation.
- Exceeds ASME B107.410 standard.

ITEM	PIECES	AVAILABLE
NO.9	6	1 On Request

### PUNCHES STRAIGHT EXTRA LONG SET

**INDUSTRIAL DUTY** **ZINC PHOSPHATE FINISH** **CHROME-VANADIUM**

Content	Length	Tip size	Hexagon
	7/2"	5/32"	5/16"
	7/2"	3/16"	3/8"
	7/2"	7/32"	3/8"
	7/2"	1/4"	3/8"
	7/2"	5/16"	1/2"
	7/2"	3/8"	1/2"



**NEW**

- Made of chrome vanadium steel.
- Chamfered striking end to minimize chip formation.
- Exceeds ASME B107.410 standard.

ITEM	PIECES	AVAILABLE
48B	6	1 On Request



**DRIFT PINS, PUNCHES, AND CHISELS SET**

**PUNCHES STRAIGHT SET**



**6 PIECES**

Content		
Length	Tip size	Hexagon
4-1/2"	1/8"	5/16"
5"	5/32"	5/16"
5"	3/16"	3/8"
5"	7/32"	3/8"
5-1/2"	1/4"	3/8"
5-1/2"	5/16"	3/8"



**NEW**

- Made of chrome vanadium steel.
- Chamfered striking end to minimize chip formation.
- Exceeds ASME B107.410 standard.

ITEM	PIECES	1	AVAILABLE
<b>47B</b>	6	1	On Request

**COLD CHISEL SET**



**3 PIECES**

Content		
length	Tip size	Hexagon
12"	5/8"	1/2"
12"	3/4"	5/8"
12"	7/8"	3/4"



**NEW**

- Made of chrome vanadium steel.
- Chamfered striking end to minimize chip formation.
- Exceeds ASME B107.410 standard.

ITEM	PIECES	1	AVAILABLE
<b>86E</b>	3	1	On Request

**CHISELS**

**COLD CUT CHISELS WITH GUARD**



**86G-5/8**



- Made of chrome vanadium steel.
- Plastic safety guard provides better control and greater confidence when striking.
- Designed for removing, cutting, or breaking materials softer than the chisel itself, such as concrete, stone, welding slag, brass, untreated steel, nuts, bolts, etc.
- Exceeds ASME B107.410 standard.

**BULK**

ITEM	TIP SIZE (A)	DIAMETER (B)	LENGTH (C)	1	AVAILABLE
<b>86G-1/2</b>	5/8"	1/2"	6-5/8"	1	On Request
<b>86G-5/8</b>	3/4"	5/8"	7"	1	✓
<b>86G-3/4x12</b>	7/8"	3/4"	12"	1	✓
<b>86G-7/8x12</b>	1"	7/8"	12"	1	On Request
<b>86G-1x12</b>	1"	1"	12"	1	✓

**COLD CUT CHISELS WITH GUARD**



**CG348**



- Made of high-carbon steel.
- Plastic safety guard provides better control and greater confidence when striking.
- Designed for removing, cutting, or breaking materials softer than the chisel itself, such as concrete, stone, welding slag, brass, untreated steel, nuts, bolts, etc.
- Complies with ASME B107.410 standard.

**BULK**

ITEM	TIP SIZE (A)	LENGTH (B)	1	AVAILABLE
<b>CG348</b>	3/4"	8"	1	On Request
<b>CG3410</b>	3/4"	10"	1	On Request
<b>CG3412</b>	3/4"	12"	1	On Request
<b>CG788</b>	7/8"	8"	1	On Request
<b>CG7810</b>	7/8"	10"	1	On Request
<b>CG7812</b>	7/8"	12"	1	On Request
<b>CG18</b>	1"	8"	1	On Request
<b>CG110</b>	1"	10"	1	On Request
<b>CG112</b>	1"	12"	1	On Request

**COLD CUT CHISELS WITH GRIP**



**86P-3/4x8**



- Made of chrome vanadium steel.
- Non-slip grip for improved control.
- Designed for removing, cutting, or breaking materials softer than the chisel itself, such as concrete, stone, welding slag, brass, untreated steel, nuts, bolts, etc.
- Exceeds ASME B107.410 standard.

**BULK**

ITEM	TIP SIZE (A)	DIAMETER (B)	LENGTH (C)	6	AVAILABLE
<b>86P-1/2</b>	5/8"	1/2"	6-5/8"	6	On Request
<b>86P-5/8</b>	3/4"	5/8"	7"	6	On Request
<b>86P-3/4x8</b>	7/8"	3/4"	8"	6	On Request
<b>86P-7/8x8</b>	1"	7/8"	8"	6	✓
<b>86P-1x8</b>	1-3/16"	1"	8-1/4"	6	On Request
<b>86P-1x12</b>	1"	1"	12"	6	✓



## CHISELS

### COLD CUT CHISELS



86A-1/2

ITEM	CHISEL SETS			
	86D	86B	86C	86A
PIECES	10	7	5	5
PACKING				
	<input type="checkbox"/>	<input type="checkbox"/>	<input type="checkbox"/>	<input type="checkbox"/>

#### BULK

ITEM	TIP SIZE (A)	DIAMETER (B)	LENGTH (C)	<input type="checkbox"/>	AVAILABLE	<input checked="" type="checkbox"/>	<input checked="" type="checkbox"/>	<input checked="" type="checkbox"/>	<input checked="" type="checkbox"/>
86A-3/16	5/16"	3/16"	4-7/8"	6	✓	•			
86A-1/4	5/16"	1/4"	5-1/8"	6	✓	•	•	•	
86A-5/16	3/8"	5/16"	5-3/8"	6	✓	•	•	•	•
86A-3/8	7/16"	3/8"	5-1/2"	6	✓	•	•	•	•
86A-7/16	1/2"	7/16"	6"	6	✓	•	•	•	•
86A-1/2	5/8"	1/2"	6-5/8"	6	✓	•	•	•	•
86A-5/8	3/4"	5/8"	7"	6	✓	•	•		
86A-3/4x8	7/8"	3/4"	8"	6	✓	•	•		•
86A-3/4x12	7/8"	3/4"	12"	6	✓				
86A-7/8x8	1"	7/8"	8"	6	✓	•			
86A-7/8x12	1"	7/8"	12"	6	✓				
86A-1x8	1-3/16"	1"	8-1/4"	6	✓	•			
86A-1x12	1"	1"	12"	6	✓				



- Made of chrome vanadium steel.
- Designed for removing, cutting, or breaking materials softer than the chisel itself, such as concrete, stone, welding slag, brass, untreated steel, nuts, bolts, etc.
- Exceeds ASME B107.410 standard.

### COLD CUT CHISELS



117132

ITEM	CHISEL SETS	
	117193	
PIECES	6	
PACKING		
	<input type="checkbox"/>	<input type="checkbox"/>

ITEM	TIP SIZE (A)	LENGTH (B)	<input type="checkbox"/>	AVAILABLE	On Request
117102	1/4"	5"	6	✓	•
117104	5/16"	6"	6	✓	
117106	3/8"	6"	6	✓	•
117108	3/8"	8"	6	✓	
117110	3/8"	10"	6	✓	
117114	1/2"	6"	6	✓	•
117116	1/2"	8"	6	✓	
117118	1/2"	10"	6	✓	
117120	1/2"	12"	6	✓	
117122	5/8"	6"	6	✓	
117124	5/8"	8"	6	✓	•
117126	5/8"	10"	6	✓	
117128	5/8"	12"	6	✓	
117154	3/4"	6"	6	✓	
117130	3/4"	8"	6	✓	•
117132	3/4"	10"	6	✓	
117134	3/4"	12"	6	✓	
117136	7/8"	8"	6	✓	
117138	7/8"	10"	6	✓	•
117140	7/8"	12"	6	✓	
117142	1"	8"	6	✓	
117144	1"	10"	6	✓	
117146	1"	12"	6	✓	



- Made of high-carbon steel.
- Designed for removing, cutting, or breaking materials softer than the chisel itself, such as concrete, stone, welding slag, brass, untreated steel, nuts, bolts, etc.
- Special anti-corrosion coating.
- Complies with ASME B107.410 standard.

**CHISELS**

**CAPE CHISELS**



HEAVY DUTY

BLACK OXIDE FINISH

CHROME-VANADIUM



- Made of chrome vanadium steel.
- Diamond-shaped edge with 52 HRC hardness for increased pressure application.
- Exceeds ASME B107.410 standard

**BULK**

ITEM	TIP SIZE (A)	DIAMETER (B)	LENGTH (C)	⊗	AVAILABLE
72-1/4	11/64"	1/4"	4-5/8"	6	✓
72-5/16	13/64"	5/16"	5-1/8"	6	✓
72-3/8	1/4"	3/8"	5 1/2"	6	✓

**PUNCH AND CHISEL HOLDERS**



HEAVY DUTY

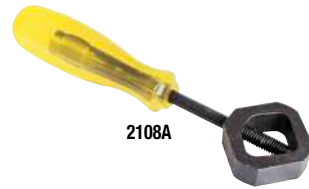

2108A

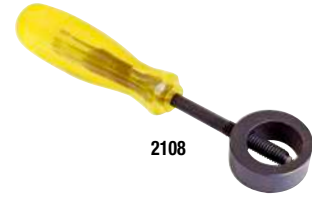

2108

- Made of chrome vanadium steel.
- Ergonomic high-strength plastic handle.
- Reduces the risk of hand injuries.
- Clamping capacity up to 1"

**BULK**

ITEM	SHAFT DIAMETER	TOTAL LENGTH	⊗	AVAILABLE
2108A	3/8"	8-1/2"	1	✓
2108	3/8"	8-1/2"	1	✓

**BRASS TAPERED AND STRAIGHT DRIFT PUNCH SET**

**BRASS TAPERED & STRAIGHT DRIFT PUNCH SET**



HEAVY DUTY

**3 PIECES**

Diameter
3/4"
1/2"
3/8"

Shaft 3/4" x tip 3/8"  
Shaft 3/4" x tip 7/16"



- Knurled grip area for improved handling.
- Designed to prevent damage to objects being struck.

**POUCH**

ITEM	PIECES	⊗	AVAILABLE
49904	3	1	✓

**BRASS STRAIGHT DRIFT PUNCH SET**



HEAVY DUTY

**3 PIECES**

Diameter
3/8"
1/2"
3/4"



- Knurled grip area for improved handling.
- Designed to prevent damage to objects being struck.

**POUCH**

ITEM	PIECES	⊗	AVAILABLE
49903	3	1	✓

**BRASS TAPERED DRIFT PUNCHES**



HEAVY DUTY



49915

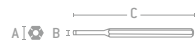

- Knurled grip area for improved handling.
- Designed to prevent damage to objects being struck.

**BULK**

ITEM	TIP DIAMETER (A)	SHAFT DIAMETER (B)	TOTAL LENGTH (C)	⊗	AVAILABLE
49915	3/8"	3/4"	10"	1	✓
49916	7/16"	3/4"	14"	1	✓

**BRASS STRAIGHT DRIFT PUNCHES**



HEAVY DUTY



49923

- Knurled grip area for improved handling.
- Designed to prevent damage to objects being struck.

**BULK**

ITEM	TIP DIAMETER (A)	SHAFT DIAMETER (B)	TOTAL LENGTH (C)	⊗	AVAILABLE
49920	1/2"	1/2"	7"	3	✓
49922	3/4"	3/4"	8"	3	✓
49923	3/4"	3/4"	12"	1	✓

## PUNCHES

### TAPERED DRIFT PUNCHES WITH GRIP



96G-5/8



- Made of chrome vanadium steel.
- Non-slip grip for improved control.
- Electrostatic coating to prevent corrosion.
- Chamfered striking end to minimize chip formation.
- Exceeds ASME B107.410 standard.

**BULK**

ITEM	WIDTH (A)	TIP SIZE (B)	TOTAL LENGTH (C)	☞	AVAILABLE
96G-1/2	1/2"	1/4"	10"	6	On Request
96G-5/8	5/8"	5/16"	10"	6	On Request
96G-3/4	3/4"	3/8"	10"	6	✓

### STRAIGHT PIN PUNCHES WITH GRIP



47G-1/2X1/4



- Made of chrome vanadium steel.
- Non-slip grip for improved control.
- Electrostatic coating to prevent corrosion.
- Chamfered striking end to minimize chip formation.
- Exceeds ASME B107.410 standard.

**BULK**

ITEM	WIDTH (A)	TIP SIZE (B)	TOTAL LENGTH (C)	☞	AVAILABLE
47G-7/16X7/32	7/16"	7/32"	6-1/2"	6	On Request
47G-1/2X1/4	1/2"	1/4"	6-3/4"	6	On Request

### STRAIGHT DRIFT PIN PUNCHES



47-1/2X1/4  
Straight pin punches



48-3/8 X 3/16  
Extra long straight pin punches

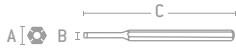

- Made of chrome vanadium steel.
- Chamfered striking end to minimize chip formation.
- Wide range of diameters and lengths to fit countless bolts, guides, holes, and more.
- Exceeds ASME B107.410 standard.

**BULK**

ITEM	WIDTH (A)	TIP SIZE (B)	TOTAL LENGTH (C)	☞	AVAILABLE	PUNCH AND DRIFT PIN SETS			
						47A	48A		
						PIECES	7	5	
						PACKING			
						☞	1	1	
						AVAILABLE	✓	✓	
<b>Straight pin punches</b>									
47-1/4X1/16	1/4"	1/16"	4-3/8"	6	✓		•		
47-1/4X3/32	1/4"	3/32"	4-3/4"	6	✓		•		
47-5/16X1/8	5/16"	1/8"	5-1/4"	6	✓		•		
47-5/16X5/32	5/16"	5/32"	5-5/8"	6	✓		•		
47-3/8X3/16	3/8"	3/16"	6-1/8"	6	✓		•		
47-7/16X7/32	7/16"	7/32"	6-1/2"	6	✓		•		
47-1/2X1/4	1/2"	1/4"	6-3/4"	6	✓		•		
<b>Extra long straight pin punches</b>									
48-3/8 X 5/32	3/8"	5/32"	8"	6	✓		•		
48-3/8 X 3/16	3/8"	3/16"	8"	6	On Request		•		
48-7/16 X 7/32	7/16"	7/32"	8"	6	✓		•		
48-1/2 X 1/4	1/2"	1/4"	8"	6	✓		•		
48-1/2 X 5/16	1/2"	5/16"	8"	6	✓		•		

### STRAIGHT PIN PUNCHES



117148

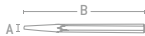

- Complies with ASME B107.410 standard.
- Assists in aligning two parts.

**BULK**

ITEM	WIDTH (A)	TOTAL LENGTH (B)	☞	AVAILABLE
117148	1/8"	6"	6	✓
117150	3/16"	6"	6	✓
117152	1/4"	6"	6	✓

## SUPERIOR Stability

usa.urrea.com

STRAIGHT PIN PUNCHES WITH GRIP

**PUNCHES**

**TAPERED DRIFT PUNCHES**



**50-3/16**  
Short tapered drift punches



**96-1/2**  
Long tapered drift punches



- Made of chrome vanadium steel.
- Chamfered striking end to minimize chip formation.
- Straight tip ideal for installing and removing guide bushings in die tooling.
- Exceeds ASME B107.410 standard.

PUNCH AND DRIFT PIN SETS			
ITEM	50A	96A	99B
PIECES	6	7	5
PACKING			

**BULK**

ITEM	WIDTH (A)	TIP SIZE (B)	TOTAL LENGTH (C)	⊞	AVAILABLE	1	1	1	
<b>Short tapered drift punches</b>									
50-3/16	3/16"	1/16"	4 1/8"	6	✓	•			
50-1/4	1/4"	3/32"	4-5/8"	6	✓	•			
50-5/16	5/16"	1/8"	5-1/8"	6	✓	•			
50-3/8	3/8"	3/16"	5-5/8"	6	✓	•			
50-7/16	7/16"	7/32"	6"	6	✓	•			
50-1/2	1/2"	1/4"	6-1/2"	6	✓	•			
<b>Long tapered drift punches</b>									
96-1/4	1/4"	3/32"	10"	6	✓		•		
96-5/16	5/16"	1/8"	10"	6	✓		•	•	
96-3/8	3/8"	3/16"	10"	6	✓		•	•	
96-7/16	7/16"	7/32"	10"	6	✓		•	•	
96-1/2	1/2"	1/4"	10"	6	✓		•	•	
96-5/8	5/8"	5/16"	10"	6	✓		•	•	
96-3/4	3/4"	3/4"	10"	6	✓		•	•	

**CENTER AND PRICK PUNCHES**

**CENTER AND PRICK PUNCHES**



**41-1/2**  
For centering or marking



**90°** FOR CENTERING OR MARKING

**44-5/8**  
For pricking or drilling



**50°** FOR PRICKING OR DRILLING



- Made of chrome vanadium steel.
- Chamfered striking end to minimize chip formation.
- 90° points are used to mark parts during manufacturing or assembly processes.
- 50° points are used to center the drilling point and prevent the drill bit from slipping.
- Exceeds ASME B107.410 standard.

PRICK PUNCH SETS		
ITEM	41A	44A
PIECES	5	5
PACKING		

**BULK**

ITEM	WIDTH (A)	TIP SIZE (B)	TOTAL LENGTH (C)	⊞	AVAILABLE	1	1	
<b>For centering or marking</b>								
41-1/4	1/4"	5/64"	4-1/4"	6	✓	•		
41-5/16	5/16"	3/32"	4-5/8"	6	✓	•		
41-3/8	3/8"	1/8"	4-7/8"	6	✓	•		
41-7/16	7/16"	5/32"	5-1/4"	6	✓	•		
41-1/2	1/2"	3/16"	5-5/8"	6	✓	•		
41-5/8	5/8"	5/16"	6-1/4"	6	✓	•		
<b>For pricking or drilling</b>								
44-1/4	1/4"	3/32"	4-3/4"	6	✓		•	
44-5/16	5/16"	7/64"	5"	6	✓		•	
44-3/8	3/8"	3/8"	5-1/4"	6	✓		•	
44-7/16	7/16"	7/32"	5-5/8"	6	✓		•	
44-1/2	1/2"	1/4"	6"	6	✓		•	
44-5/8	5/8"	3/8"	6-7/8"	6	✓		•	

**CENTER PUNCHES**



**117162**  
For centering or marking



**117170**  
For pricking or drilling

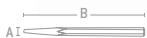

- Made of high-carbon steel.
- 90° points are used to mark parts during manufacturing or assembly processes.
- 50° points are used to center the drilling point and prevent the drill bit from slipping.
- Complies with ASME B107.410 standard.

**BULK**

ITEM	WIDTH (A)	TOTAL LENGTH (B)	⊞	AVAILABLE
<b>For centering or marking</b>				
117162	1/4"	3 1/2"	6	✓
117164	3/8"	5"	6	✓
117166	1/2"	6"	6	✓
<b>For pricking or drilling</b>				
117170	3/8"	5"	6	✓

## STRIKING LETTERS AND NUMBERS

### STRIKING LETTERS A-Z



27  
PIECES



Letters **E E E E E**  
size 5/32" 3/16" 1/4" 5/16" 3/8" 42L8

- Item** 42L4 42L5 42L6 42L8 42L10
- Made of high-strength carbon steel.
  - Induction-hardened tip for superior impact and deformation resistance.
  - Chamfered striking end to minimize chip formation.
  - Ideal for marking special parts; perfect for workshops and industrial use.

ITEM	PIECES	SIZES	AVAILABILITY
42L4	27	5/32" (4 mm)	On Request
42L5	27	3/16" (5 mm)	On Request
42L6	27	1/4" (6 mm)	On Request
42L8	27	5/16" (8 mm)	On Request
42L10	27	3/8" (10 mm)	On Request

### STRIKING NUMBERS 0-9



9  
PIECES



Numbers **8 8 8 8 8**  
size 5/32" 3/16" 1/4" 5/16" 3/8" 42N6

- Item** 42N4 42N5 42N6 42N8 42N10
- Made of high-strength carbon steel.
  - Induction-hardened tip for superior impact and deformation resistance.
  - Chamfered striking end to minimize chip formation.
  - Ideal for marking special parts; perfect for workshops and industrial use.

ITEM	PIECES	SIZES	AVAILABILITY
42N4	9	5/32" (4 mm)	On Request
42N5	9	3/16" (5 mm)	On Request
42N6	9	1/4" (6 mm)	On Request
42N8	9	5/16" (8 mm)	On Request
42N10	9	3/8" (10 mm)	On Request

STRIKING AND STRUCK TOOLS

### CHISELS

#### CONCRETE CHISEL HEXAGONAL STEEL BODY



NEW

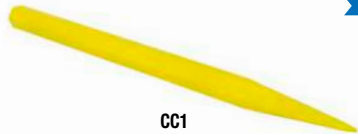

CC1



- Made of chrome vanadium steel.
- Heat-treated for high performance.

BULK

ITEM	WIDTH (A)	TOTAL LENGTH (B)	WEIGHT	AVAILABILITY
CC5	3/4"	11.8"	1.5 lb	On Request
CC4	7/8"	13.7"	2.4 lb	On Request
CC1	1"	15.7"	3.7 lb	On Request
CC2	1-1/4"	20"	7.4 lb	On Request
CC3	1-1/2"	24"	12.7 lb	On Request

### HAMMERS

#### RUBBER GRIP ANTI-VIBRATION INDESTRUCTIBLE HANDLE SLEDGE HAMMERS



1437HD

- Made of high-carbon steel with heat treatment.
- Steel rod core secured to the head for maximum impact resistance.
- Steel locking plate eliminates the risk of head separation.
- Rubber grip handle absorbs vibration.
- Exceeds ASME B107.400, Federal GGG-H-86-C, and BS 876 standards.

BULK

ITEM	HEAD WEIGHT	FACE DIAMETER (A)	HEAD LENGTH (B)	HANDLE LENGTH (C)	AVAILABILITY
1435HD	4 lbs	2"	4-1/2"	16"	On Request
1437HD	8 lbs	2-6/16"	6-1/4"	30"	On Request
1439HD	12 lbs	2-11/16"	7-9/16"	30"	On Request
1441HD	14 lb	2-15/16"	7-3/4"	30"	On Request
1442HD	20 lb	3-3/16"	8-13/16"	36"	On Request

#### RUBBER GRIP ANTI-VIBRATION HANDLE SLEDGE HAMMERS



1434A

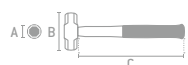

- Tri-material handle that absorbs vibration.
- Head secured with epoxy resin.
- Exceeds ASME B107.400, Federal GGG-H-86-C, and BS 876 standards.

BULK

ITEM	HEAD WEIGHT	FACE DIAMETER (A)	HEAD LENGTH (B)	HANDLE LENGTH (C)	AVAILABILITY
1433A	2 lbs	n/a	3-23/32"	10-1/4"	✓
1434A	3 lbs	n/a	4-19/64"	10-1/4"	✓
1435A	4 lbs	n/a	4-11/16"	11"	✓

#### RUBBER GRIP ANTI-VIBRATION HANDLE ONE-PIECE FORGED OCTAGONAL SLEDGE HAMMERS



1434AF

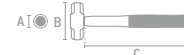

- Forged in one piece from high-carbon steel with heat treatment.
- Rubber grip handle that absorbs vibration.
- Exceeds ASME B107.400, Federal GGG-H-86-C, and BS 876 standards.

BULK

ITEM	HEAD WEIGHT	FACE DIAMETER (A)	HEAD LENGTH (B)	HANDLE LENGTH (C)	AVAILABILITY
1434AF	3 lbs	1-11/64"	4-3/16"	12-13/64"	On Request
1435AF	4 lbs	1-9/16"	4-11/32"	12-19/32"	On Request

**HAMMERS**

**RUBBER GRIP HANDLE ONE-PIECE FORGED OCTAGONAL SLEDGE HAMMERS**



**MARR3X**

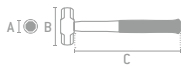

- Forged in one piece from high-carbon steel with heat treatment.
- Complies with ASME B107.400, Federal GGG-H-86-C, and BS 876 standards.

**BULK**

ITEM	HEAD WEIGHT	FACE DIAMETER (A)	HEAD LENGTH (B)	HANDLE LENGTH (C)	☞	AVAILABLE
<b>MARR3X</b>	3 lbs	1-1/16"	4-3/16"	9"	1	On Request
<b>MARR4X</b>	4 lbs	1-1/16"	4-1/2"	9"	1	On Request

**SHORT FIBERGLASS HANDLE FORGED OCTAGONAL SLEDGE HAMMERS**



**MAR3FV**  
12" handle



**MAR10FV**  
36" handle

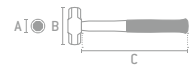

- Made of high-carbon steel with heat treatment.
- Polished striking surface.
- Complies with ASME B107.400 standard.

**BULK**

ITEM	HEAD WEIGHT	FACE DIAMETER (A)	HEAD LENGTH (B)	HANDLE LENGTH (C)	☞	AVAILABLE
<b>MAR2FV</b>	2 lbs	1-5/8"	4-1/2"	12"	2	On Request
<b>MAR3FV</b>	3 lbs	1-3/4"	5-1/8"	12"	2	On Request
<b>MAR4FV</b>	4 lbs	2-1/16"	5-5/8"	12"	2	On Request
<b>MAR6FV</b>	6 lbs	2-3/16"	6"	36"	2	On Request
<b>MAR8FV</b>	8 lbs	2-3/8"	6-1/2"	36"	2	On Request
<b>MAR10FV</b>	10 lbs	2-1/2"	6-7/8"	36"	2	On Request
<b>MAR12FV</b>	12 lbs	7-11/16"	7-11/16"	36"	2	On Request
<b>MAR14FV</b>	14 lbs	2-11/16"	8"	36"	2	On Request
<b>MAR16FV</b>	16 lbs	2-13/16"	8-7/16"	36"	1	On Request

**FIBERGLASS HANDLE MACHINED OCTAGONAL HEAD SLEDGE HAMMERS**



**1434GFV**  
15-1/4" handle



**1438GFV**  
36" handle

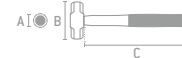

- Made of high-carbon steel with heat treatment.
- Fiberglass handle with integrated overstrike protection.
- Head coated with electrostatic paint.
- Exceeds ASME B107.400 standard.

**BULK**

ITEM	HEAD WEIGHT	FACE DIAMETER (A)	HEAD LENGTH (B)	HANDLE LENGTH (C)	☞	AVAILABLE
<b>1433GFV</b>	2 lbs	1-5/8"	4-1/2"	15-1/4"	1	✓
<b>1434GFV</b>	3 lbs	1-3/4"	5-1/8"	15-1/4"	1	✓
<b>1435GFV</b>	4 lbs	2-1/16"	5-5/8"	15-1/4"	1	✓
<b>1436GFV</b>	6 lbs	2-3/16"	6"	36"	1	✓
<b>1437GFV</b>	8 lbs	2-3/8"	6-1/2"	36"	1	✓
<b>1438GFV</b>	10 lbs	2-1/2"	6-7/8"	36"	1	✓
<b>1439GFV</b>	12 lbs	2-11/16"	7-11/16"	36"	1	✓
<b>1440GFV</b>	16 lbs	2-15/16"	8-7/16"	36"	1	✓

**WOODEN HANDLE MACHINED OCTAGONAL HEAD SLEDGE HAMMERS**



**1434G**  
12" handle



**1434EG**  
16" handle



**1438G**  
36" handle

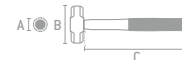

- Made of high-carbon steel with heat treatment.
- Polished and waxed wooden handle with integrated overstrike protection.
- Head coated with electrostatic paint.
- Exceeds ASME B107.400 standard.

**BULK**

ITEM	HEAD WEIGHT	FACE DIAMETER (A)	HEAD LENGTH (B)	HANDLE LENGTH (C)	☞	AVAILABLE
<b>1433G</b>	2 lbs	1-5/8"	4-1/2"	12"	1	✓
<b>1434G</b>	3 lbs	1-3/4"	5-1/8"	12"	1	✓
<b>1435G</b>	4 lbs	2-1/16"	5-5/8"	12"	1	✓
<b>1433EG</b>	2 lbs	1-5/8"	4-1/2"	16"	1	✓
<b>1434EG</b>	3 lbs	1-3/4"	5-1/8"	16"	1	✓
<b>1435EG</b>	4 lbs	2-1/16"	5-5/8"	16"	1	✓
<b>1436G</b>	6 lbs	2-3/16"	6"	36"	1	✓
<b>1437G</b>	8 lbs	2-3/8"	6-1/2"	36"	1	✓
<b>1438G</b>	10 lbs	2-1/2"	6-7/8"	36"	1	✓
<b>1439G</b>	12 lbs	2-11/16"	7-11/16"	36"	1	✓
<b>1440G</b>	16 lbs	2-15/16"	8-7/16"	36"	1	✓

## HAMMERS

### WOODEN HANDLE FORGED OCTAGONAL SLEDGE HAMMERS

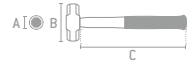
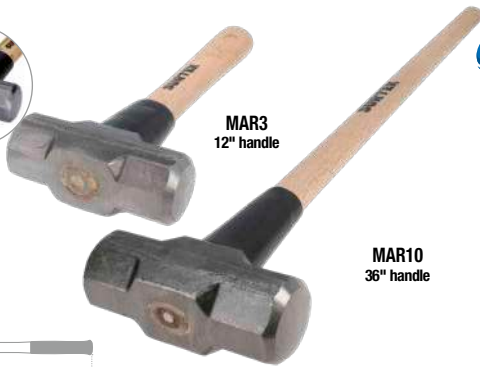

- Made of high-carbon steel with heat treatment.
- Polished and waxed wooden handle with integrated overstrike protection.
- Polished striking surface.
- Complies with ASME B107.400 standard.

**BULK**

ITEM	HEAD WEIGHT	FACE DIAMETER (A)	HEAD LENGTH (B)	HANDLE LENGTH (C)	⊞	AVAILABLE
MAR2	2 lbs	1-5/8"	4-1/2"	12"	2	On Request
MAR3	3 lbs	1-3/4"	5-1/8"	12"	2	On Request
MAR4	4 lbs	2-1/16"	5-5/8"	12"	6	On Request
MAR6	6 lbs	2-3/16"	6"	36"	6	On Request
MAR8	8 lbs	2-3/8"	6-1/2"	36"	6	On Request
MAR10	10 lbs	2-1/2"	6-7/8"	36"	6	On Request
MAR12	12 lbs	2-11/16"	7-11/16"	36"	2	On Request
MAR14	14 lbs	2-11/16"	8"	36"	2	On Request
MAR16	16 lbs	2-15/16"	8-7/16"	36"	1	On Request

STRIKING AND STRUCK TOOLS

### REPLACEMENT SPARE WOODEN HANDLE FOR SLEDGE HAMMERS



CAB10  
36"



- Includes metal and wooden wedge.

**BULK**

ITEM	HANDLE LENGTH	⊞	AVAILABLE
CAB7	12"	3	✓
CAB10	36"	6	✓

### FIBERGLASS HANDLE BRONZE HAMMERS

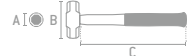

1430FV

- Ideal for maintenance work, dies, and molds.
- Designed to prevent damage to objects being struck.
- Fiberglass handle with integrated overstrike protection.
- Exceeds ASME B107.400 and Federal GGG-H-33A standards.

**BULK**

ITEM	HEAD WEIGHT	FACE DIAMETER (A)	HEAD LENGTH (B)	HANDLE LENGTH (C)	⊞	AVAILABLE
1430FV	1.6 lbs	1-3/8"	3-7/16"	13"	1	✓
1432FV	3.1 lbs	2"	3-3/4"	15"	1	✓

### WOODEN HANDLE BRONZE HAMMERS

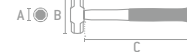

1430

- Polished and waxed wooden handle.
- Exceeds ASME B107.400 and Federal GGG-H-33A standards.

**BULK**

ITEM	HEAD WEIGHT	FACE DIAMETER (A)	HEAD LENGTH (B)	HANDLE LENGTH (C)	⊞	AVAILABLE
1430	1.6 lbs	1-3/8"	3-7/16"	14"	1	✓
1432	3.1 lbs	2"	3-3/4"	18"	1	✓

### NON-SLIP HANDLE DEAD BLOW IMPACT SLEDGE HAMMERS



FIBERGLASS HANDLE



LARGER IMPACT SURFACE

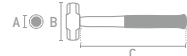

1436DB

- Internal steel shot system that prevents rebound and controls the hammer upon impact.
- Ideal for maintenance work, dies, and molds.
- Designed to prevent damage to objects being struck.
- More resistant to cuts, dents, and abrasion than rubber or urethane mallets.

**BULK**

ITEM	HEAD WEIGHT	FACE DIAMETER (A)	HEAD LENGTH (B)	HANDLE LENGTH (C)	⊞	AVAILABLE
1436DB	6 lbs	2-3/4"	7-3/32"	20"	1	✓
1439DB	12 lbs	3-1/8"	8"	36-1/2"	1	✓

### RACK WITH SLEDGE HAMMER FIBERGLASS AND AMERICAN WOODEN HANDLE

30 PIECES

Contents	Quantity
RMARRU	1
1436G	4
1437G	4
1438G	4
1439G	4
1440G	4
1436GFV	2
1437GFV	2
1438GFV	2
1439GFV	2
1440GFV	2



CONTENIDO

ITEM	DESCRIPTION	⊞	AVAILABLE
RMARRUC	Sledge rack with hammer fiberglass and American wooden handles	1	✓



**BALL PEIN HAMMERS**

**RUBBER GRIP INDESTRUCTIBLE HANDLE BALL PEIN HAMMERS**

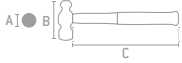

1324HD

- Made of high-carbon steel with heat treatment.
- Steel rod core fixed to the head to withstand any impact.
- Steel retention plate that eliminates the risk of head detachment.
- Rubber grip handle that absorbs vibration.
- Exceeds ASME B107.400 and Federal GGG-H-86C standards.

**BULK**

ITEM	HEAD WEIGHT	FACE DIAMETER (A)	HEAD LENGTH (B)	HANDLE LENGTH (C)	☐	AVAILABLE
1316HD	16 oz	1-1/2"	4"	14"	1	On Request
1320HD	20 oz	1-9/16"	4-9/32"	14"	1	On Request
1324HD	24 oz	1-1/4"	4-1/2"	14"	1	On Request
1332HD	32 oz	1-1/2"	5"	14"	1	On Request
1348HD	48 oz	1-7/8"	5-9/16"	14"	1	On Request

**TEXTURED HANDLE ANTI-VIBRATION ONE-PIECE FORGED BALL PEIN HAMMERS**

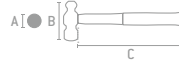

- Forged from a single piece of high carbon steel with heat treatment.
- Rubber grip handle that absorbs vibration.
- Exceeds ASME B107.400 and Federal GGG-H-86-C standards.

**BULK**

ITEM	HEAD WEIGHT	FACE DIAMETER (A)	HEAD LENGTH (B)	HANDLE LENGTH (C)	☐	AVAILABLE
1324AF	24 oz	1-5/16"	4-1/2"	13-31/32"	1	On Request

**FIBERGLASS SHORT HANDLE ANTI-VIBRATION FORGED BALL PEIN HAMMERS**



1324FVS

- Made of high-carbon steel with heat treatment.
- Fiberglass handle with integrated overstrike protection.
- Head coated with electrostatic paint.
- Exceeds ASME B107.400 standard.

**BULK**

ITEM	HEAD WEIGHT	FACE DIAMETER (A)	HEAD LENGTH (B)	HANDLE LENGTH (C)	☐	AVAILABLE
1324FVS	24 oz	1-1/2"	4-7/8"	9"	1	✓
1332FVS	32 oz	1-5/8"	5-1/8"	9"	1	✓

**FIBERGLASS HANDLE POLISHED BALL PEIN HEAD HAMMERS**

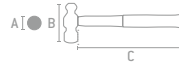

1332FV

- Made of high-carbon steel with heat treatment.
- Fiberglass handle with integrated overstrike protection.
- Head coated with electrostatic paint.
- Exceeds ASME B107.400 standard.

**BULK**

ITEM	HEAD WEIGHT	FACE DIAMETER (A)	HEAD LENGTH (B)	HANDLE LENGTH (C)	☐	AVAILABLE
1308FV	8 oz	1"	3-1/2"	13"	1	✓
1312FV	12 oz	1-3/16"	3-3/4"	13"	1	✓
1316FV	16 oz	1-5/16"	4-7/32"	13"	1	✓
1324FV	24 oz	1-1/2"	4-7/8"	15"	1	✓
1332FV	32 oz	1-5/8"	5-1/8"	15"	1	✓
1340FV	40 oz	1-3/4"	5-9/16"	15"	1	✓

**HICKORY HANDLE POLISHED BALL PEIN HEAD HAMMERS**

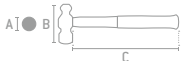

1332P

- Made of high-carbon steel with heat treatment.
- Polished and waxed wooden handle.
- Head coated with electrostatic paint.
- Exceeds ASME B107.400 standard.

**BULK**

ITEM	HEAD WEIGHT	FACE DIAMETER (A)	HEAD LENGTH (B)	HANDLE LENGTH (C)	☐	AVAILABLE
1308P	8 oz	1"	3-1/2"	12-3/8"	1	✓
1312P	12 oz	1-3/16"	3-3/4"	12-3/8"	1	✓
1316P	16 oz	1-5/16"	4-7/32"	13"	1	✓
1324P	24 oz	1-1/2"	4-7/8"	16"	1	✓
1332P	32 oz	1-5/8"	5-1/8"	16"	1	✓
1340P	40 oz	1-3/4"	5-9/16"	18"	1	✓
1348P	48 oz	1 7/8"	5-7/8"	18"	1	✓

**WOODEN HANDLE BLACK BALL PEIN HAMMERS**

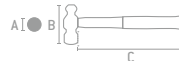

- Made of high-carbon steel with heat treatment.
- Polished and waxed wooden handle.
- Head coated with electrostatic paint.
- Exceeds ASME B107.400 standard.

**BULK**

ITEM	HEAD WEIGHT	FACE DIAMETER (A)	HEAD LENGTH (B)	HANDLE LENGTH (C)	☐	AVAILABLE
1308PN	8 oz	1"	3-1/2"	12-3/8"	1	✓
1312PN	12 oz	1-3/16"	3-3/4"	14"	1	✓
1316PN	16 oz	1-5/16"	4-7/32"	14"	1	✓
1324PN	24 oz	1-1/2"	4-7/8"	16"	1	✓
1332PN	32 oz	1-5/8"	5-1/8"	16"	1	✓
1340PN	40 oz	1-3/4"	5-9/16"	18"	1	✓
1348PN	48 oz	1 7/8"	5-7/8"	18"	1	✓

## BALL PEIN HAMMERS

### ERGONOMIC WOODEN HANDLE BLACK BALL PEIN HAMMERS

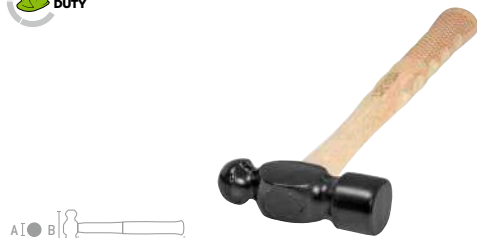

1324E

- Made of high-carbon steel with heat treatment.
- Grooved wooden handle for improved grip.
- Head coated with electrostatic paint.
- Exceeds ASME B107.400 standard.

**BULK**

ITEM	HEAD WEIGHT	FACE DIAMETER (A)	HEAD LENGTH (B)	HANDLE LENGTH (C)	⊞	AVAILABLE
1324E	24 oz	1-1/2"	4-7/8"	16"	1	✓
1332E	32 oz	1-5/8"	5-1/8"	16"	1	✓

### WOODEN HANDLE POLISHED BALL PEIN HEAD HAMMERS



24S

- Made of high-carbon steel with heat treatment.
- Polished striking surface.
- Complies with ASME B107.400 standard.

**BULK**

ITEM	HEAD WEIGHT	FACE DIAMETER (A)	HANDLE LENGTH (B)	⊞	AVAILABLE
8S	8 oz	1"	13"	1	On Request
12S	12 oz	1-1/4"	13"	1	On Request
16S	16 oz	1-1/4"	14"	1	On Request
24S	24 oz	1-1/2"	16"	1	On Request
32S	32 oz	1-1/2"	16"	1	On Request
40S	40 oz	1-5/8"	17"	1	On Request
48S	48 oz	1-1/8"	17"	1	On Request

STRIKING AND STRUCK TOOLS

### SPARE WOODEN HANDLE FOR MODELS 1324E AND 1332E



- Includes wood and metal wedges.

**BULK**

ITEM	LENGTH	⊞	AVAILABLE
CAB6U	16"	1	✓

### SPARE WOODEN HANDLE BALL PEIN HAMMERS



- Includes wood and metal wedges.

**BULK**

ITEM	LENGTH	⊞	AVAILABLE
CAB2UH	14"	1	✓

### SPARE WOODEN HANDLE BALL PEIN HAMMERS



CAB1  
13" handle

- Includes wooden and metal wedges

**BULK**

ITEM	LENGTH	FOR ITEM	⊞	AVAILABLE
CAB1	13"	8S y 12S	1	✓
CAB3	16"	24S y 32S	1	✓
CAB4	17"	40S y 48S	1	✓

## FACE HAMMERS

### DEAD BLOW BALL PEIN HAMMERS

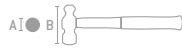

- Internal steel shot system that prevents rebound and controls the hammer upon impact.
- Body made of high-impact polyurethane with a non-slip handle.
- Beveled steel head to prevent chipping.

1326DB

**BULK**

ITEM	MATERIAL HEAD	TOTAL WEIGHT	FACE DIAMETER (A)	HEAD LENGTH (B)	⊞	AVAILABLE
1326DB	Rubber	26 oz	1-15/64"	4-1/4"	1	✓
1336DB	Rubber	36 oz	1-15/32"	4-1/2"	1	On Request
1344DB	Rubber	44 oz	1-11/16"	4-7/8"	1	✓

### ANTI-VIBRATION HANDLE WITH PLASTIC FACE HAMMER



- Aluminum head with high-strength interchangeable faces.
- Unbreakable anti-vibration handle that extends the hammer's service life and reduces the risk of accidents.
- Ideal for striking soft materials without causing damage.
- Exceeds Federal GGG-H-33A standard.



**BULK**

ITEM	HEAD WEIGHT	FACE DIAMETER	FACE DIAMETER (A)	HEAD LENGTH (B)	⊞	AVAILABLE
1383A	16 oz	1-35/64"	4-19/64"		1	✓

### FIBERGLASS HANDLE WITH FIXED PLASTIC FACE HAMMER

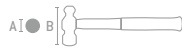

- Durable plastic faces that prevent hammer rebound.
- Fiberglass handle with integrated overstrike protection.
- Designed for striking soft materials where heavy impact is not needed.
- Exceeds Federal GGG-H-33A standard.



**BULK**

ITEM	HEAD WEIGHT	FACE DIAMETER	FACE DIAMETER (A)	HEAD LENGTH (B)	⊞	AVAILABLE
1383FV	13 oz	1-5/6"	3-15/32"	11-1/4"	1	✓

### WOODEN HANDLE WITH FIXED PLASTIC FACE HAMMER



- Durable plastic faces that prevent hammer rebound.
- Polished and waxed wooden handle.
- Designed for striking soft materials where heavy impact is not needed.
- Exceeds Federal GGG-H-33A standard.



**BULK**

ITEM	HEAD WEIGHT	FACE DIAMETER	FACE DIAMETER (A)	HEAD LENGTH (B)	⊞	AVAILABLE
1383	13 oz	1-5/6"	3-15/32"	11-1/2"	1	✓

**FACE HAMMERS**

**WOODEN HANDLE WITH FIXED PLASTIC FACE HAMMERS**



- Beige face with 95 Shore hardness for heavy-duty use.
- Gray face with 60 Shore hardness for extra soft use.
- Polished and waxed wooden handle.
- Exceeds Federal GGG-H-33A standard.



**BULK**

ITEM	HEAD WEIGHT	FACE DIAMETER	FACE DIAMETER (A)	HEAD LENGTH (B)	⊞	AVAILABLE
1364	13 oz	1-1/2"	3-3/8"	12-3/32"	1	✓
1363	13 oz	1-7/8"	4-3/4"	16"	1	✓
1362	25 oz	2-13/32"	2-13/32"	18"	1	✓

**SPARE INTERCHANGEABLE RUBBER HAMMER FACES**



**BULK**

ITEM	STRIKE TYPE	SHORE HARDNESS	FACE COLOR	REPLACEMENT FOR	⊞	AVAILABLE
1364XS	Extra soft	60	●	1364	1	✓
1364T	Rugged use	95	●	1364	1	✓
1363XS	Extra soft	60	●	1363	1	✓
1363T	Rugged use	95	●	1363	1	✓
1362XS	Extra soft	60	●	1362	1	✓
1362T	Rugged use	95	●	1362	1	✓

**CLAW HAMMERS**

**ANTI-VIBRATION INDESTRUCTIBLE HANDLE CLAW HAMMER**

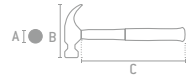

- Made of high-carbon steel with heat treatment.
- Steel rod core fixed to the head to withstand any impact.
- Steel retention plate that eliminates the risk of head detachment.
- Rubber grip handle that absorbs vibration.
- Exceeds ASME B107.400 and Federal GGG-H-86C standards.



**BULK**

ITEM	HEAD WEIGHT	FACE DIAMETER (A)	HEAD LENGTH (B)	HANDLE LENGTH (C)	⊞	AVAILABLE
1616HD	16 oz	1-1/8"	5"	13"	1	On Request

**FIBERGLASS HANDLE CURVED CLAW HAMMER**

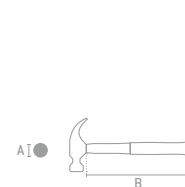

- Made of high-carbon steel with heat treatment.
- Fiberglass handle that absorbs vibration.
- Fully polished head.
- Complies with ASME B107.400 standard.



**BULK**

ITEM	HEAD WEIGHT	FACE DIAMETER (A)	HANDLE LENGTH (B)	⊞	AVAILABLE
416F	16 oz	1-3/16"	14"	1	On Request

**WOODEN HANDLE MILLED FACE CALIFORNIA STRAIGHT CLAW HAMMER**

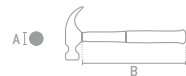

- Made of high-carbon steel with heat treatment.
- Milled face that improves precision and safety during work.
- Polished and waxed wooden handle.
- Complies with ASME B107.400 standard.



**BULK**

ITEM	HEAD WEIGHT	FACE DIAMETER (A)	HANDLE LENGTH (B)	⊞	AVAILABLE
425CF	25 oz	1-3/16"	16"	1	✓

**WOODEN HANDLE MILLED FACE RIPPING STRAIGHT CLAW HAMMER**



- Made of high-carbon steel with heat treatment.
- Milled face that improves precision and safety during work.
- Polished and waxed wooden handle.
- Complies with ASME B107.400 standard.



**BULK**

ITEM	HEAD WEIGHT	FACE DIAMETER (A)	HANDLE LENGTH (B)	⊞	AVAILABLE
424CF	24 oz	1-3/16"	16"	1	✓

**WOODEN HANDLE POLISHED HEAD STRAIGHT CLAW HAMMER**

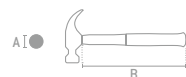

- Made of high-carbon steel with heat treatment.
- Fully polished head.
- Polished and waxed wooden handle.
- Complies with ASME B107.400 standard.



**BULK**

ITEM	HEAD WEIGHT	FACE DIAMETER (A)	HANDLE LENGTH (B)	⊞	AVAILABLE
416PR	16 oz	1-3/8"	14"	1	✓
420PR	20 oz	1-3/8"	14"	1	✓

**SPECIALTY HAMMERS**

**FIBERGLASS HANDLE WELDER LABOR HAMMER**

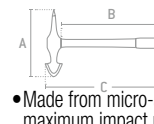

- Made from micro-alloyed steel for maximum impact resistance.
- Fiberglass handle with integrated overstrike protection.
- Ideal for removing slag in welding work, both on flat surfaces and in corners.



**BULK**

ITEM	HEAD WEIGHT	HEAD LENGTH (A)	HANDLE LENGTH (B)	TOTAL LENGTH (C)	⊞	AVAILABLE
1410	12 oz	7 1/4"	11-1/4"	12"	1	✓

## SPECIALTY HAMMERS

### BODYWORK HAMMERS WITH FIBERGLASS HANDLE



URREA  
SUPERIOR QUALITY AFFORDABLE TOOLS

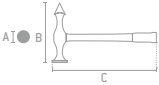

- Made from micro-alloyed steel for maximum impact resistance.
- Polished heads for superior finishing in auto body work.
- Bi-material fiberglass handle for improved grip.



1424FV

- Flat round and flat square heads, specially designed to smooth damaged metal surfaces, particularly in corner areas.



1427FV

- Features a flat round head and a narrow head, ideal for finishing work on edges and moldings.



1428FV

- Flat head and long point dent hammer, ideal for smoothing dents in sheet metal and deep or recessed areas.

**BULK**

ITEM	DESCRIPTION	FACE DIAMETER (A)	HEAD LENGTH (B)	TOTAL LENGTH (C)	⊕	AVAILABLE
1424FV	With fiberglass handle, for smooth finishes	1-1/4"	4"	13"	1	✓
1427FV	With fiberglass handle, for finishes	1-3/8"	4-1/2"	13"	1	✓
1428FV	With fiberglass handle, for sheet straightening	1-3/8"	5-7/8"	13"	1	✓

### BODYWORK HAMMERS WITH WOODEN HANDLE



URREA  
SUPERIOR QUALITY AFFORDABLE TOOLS

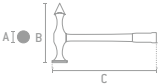

- Made from micro-alloyed steel for maximum impact resistance.
- Polished heads for superior finishing in auto body work.
- Waxed and engraved wooden handle for a more comfortable grip.



1421

- With two flat heads, ideal for sheet metal straightening.



1424

- Flat round and flat square heads, specially designed to smooth damaged metal surfaces, particularly in corner areas.



1427

- Features a flat round head and a narrow head, ideal for finishing work on edges and moldings.



1428

- Flat head and long point dent hammer, ideal for smoothing dents in sheet metal and deep or recessed areas.

**BULK**

ITEM	DESCRIPTION	FACE DIAMETER (A)	HEAD LENGTH (B)	TOTAL LENGTH (C)	⊕	AVAILABLE
1421	Two head wood handle, for sheet straightening	1-1/4"	6"	13-3/4"	1	✓
1427	With wood handle, for finishes	1-3/8"	4-1/2"	12-1/4"	1	✓
1424	With wood handle, for smooth finishes	1-1/4"	4"	13"	1	✓
1428	One head wood handle, for sheet straightening	1-1/2"	5-7/8"	14"	1	✓

### AMERICAN HICKORY WOODEN HANDLE MASONRY HAMMERS



SURTEK  
TOOLS FOR SPECIALISTS

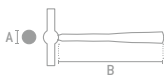

- Made of high-carbon steel with heat treatment.
- Fully polished head.
- Complies with ASME B107.400 and Federal GGG-H-86C standard.

**BULK**

ITEM	HEAD WEIGHT	FACE DIAMETER (A)	TOTAL LENGTH (B)	⊕	AVAILABLE
117018	24 oz	1-1/8"	13"	1	On Request

### AMERICAN HICKORY WOODEN HANDLE UPHOLSTERER HAMMERS



SURTEK  
TOOLS FOR SPECIALISTS

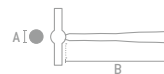

- Magnetized to facilitate the installation of nails and staples.
- Made of high-carbon steel with heat treatment.
- Fully polished head.
- Complies with ASME B107.400 and Federal GGG-H-86C standard.

**BULK**

ITEM	HEAD WEIGHT	FACE DIAMETER (A)	TOTAL LENGTH (B)	⊕	AVAILABLE
852124	7 oz	1-3/16"	13"	1	On Request

**MALLETS**

**WOODEN HANDLE RUBBER HEAD MALLETS**



- Ideal for flooring and tile installation.
- Head made of neoprene rubber that absorbs strong impacts without damaging or staining the surface.
- Polished and waxed wooden handle.
- Exceeds Federal GGG-H-33A standard.



**1366**



**1368B**



**1368G**

**URREA**



**BULK**

ITEM	COLOR	HEAD WEIGHT	FACE DIAMETER (A)	HEAD LENGTH (B)	HANDLE LENGTH (C)	☞	AVAILABLE
<b>1366</b>	Black ●	8 oz	1-25/32"	3-1/16"	12-3/8"	1	✓
<b>1367</b>	Black ●	16 oz	2-3/16"	3-3/4"	14"	1	✓
<b>1368</b>	Black ●	22 oz	2-5/8"	4-1/2"	16"	1	✓

ITEM	COLOR	HEAD WEIGHT	FACE DIAMETER (A)	HEAD LENGTH (B)	HANDLE LENGTH (C)	☞	AVAILABLE
<b>1368B</b>	Beige ●	22 oz	2-5/8"	4-1/2"	16"	1	✓
<b>1368G</b>	Grey ●	22 oz	2-5/8"	4-1/2"	16"	1	✓

**WOODEN HANDLE RUBBER HEAD MALLETS**

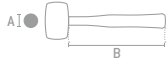

- Ideal for flooring and tile installation.
- Head made of neoprene rubber that absorbs strong impacts without damaging or staining the surface.
- Complies with Federal GGG-H-33A standard.



**616**  
Black color rubber



**608B**  
White color rubber

**SURTEK**



**BULK**

ITEM	COLOR	HEAD WEIGHT	FACE DIAMETER (A)	HANDLE LENGTH (B)	☞	AVAILABLE
<b>608</b>	Black ●	8 oz	1-25/32"	12"	1	✓
<b>616</b>	Black ●	16 oz	2-3/16"	14"	1	✓
<b>600</b>	Black ●	22 oz	2-5/8"	16"	1	✓

ITEM	COLOR	HEAD WEIGHT	FACE DIAMETER (A)	HANDLE LENGTH (B)	☞	AVAILABLE
<b>608B</b>	White ○	8 oz	5/8"	11"	1	On Request
<b>616B</b>	White ○	16 oz	5/8"	12"	1	On Request
<b>600B</b>	White ○	24 oz	5/8"	12-1/2"	1	On Request

**IMPACT CARBON SCRAPER HOOK AND PICK SET**

**IMPACT CARBON SCRAPER SET**



**4**  
**PIECES**

**URREA**



- Bars made from tempered alloy steel for maximum durability.
- Impact sleeve attached to the bar allows striking the end without damaging the handle and facilitates scraping or removal operations



ITEM	SIZES	TOTAL LENGTH	☞	AVAILABLE
<b>JRASP4</b>	1/2", 3/4", 1" & 1-1/2"	10"	1	✓

**IMPACT HOOK AND PICK SET**



**4**  
**PIECES**

**URREA**



- Designed for pulling or aligning bolts, rings, cables, seals, gears, bearings, and small parts in general.
- Impact sleeve attached to the bar allows striking the end without damaging the handle.



ITEM	TIPS	TOTAL LENGTH	☞	AVAILABLE
<b>JGP4</b>	Scratch awl, 90°, curved & complex	10"	1	✓

## HOLLOW PUNCHES

### HOLLOW PUNCH SET FROM 1/8" TO 2



**28**  
PIECES

Content				
1/8"	7/16"	7/8"	1-1/4"	1-5/8"
3/16"	1/2"	1"	1-5/16"	1-11/16"
1/4"	9/16"	1-1/16"	1-3/8"	1-3/4"
5/16"	5/8"	1-1/8"	1-7/16"	1-7/8"
3/8"	3/4"	1-3/16"	1-1/2"	2"

**Accessories**  
Handle adapter  
Centering tip



URREA



- Pistol-style handle.
- System for using multiple hole punches simultaneously.
- Ideal for cutting washers and sealing rings made of foam, cardboard, leather, rubber, fiber, plastic, and thin steel sheet.

ITEM	PIECES	☐	AVAILABLE
49902A	28	1	✓

### HOLLOW PUNCH SET FROM 1/8" TO 2



**27**  
PIECES

Content				
1/8"	3/16"	1/4"	5/16"	3/8"
7/16"	1/2"	9/16"	5/8"	3/4"
7/8"	1"	1-1/16"	1-1/8"	1-3/16"
1-1/4"	1-5/16"	1-3/8"	1-7/16"	1-1/2"
1-5/8"	1-11/16"	1-3/4"	1-7/8"	2"

**Accessories**  
Handle adapter  
Plastic case



URREA



- Ideal for cutting washers and sealing rings made of foam, cardboard, leather, rubber, fiber, plastic, and thin steel sheet.

ITEM	PIECES	☐	AVAILABLE
49902	27	1	✓

### HOLLOW PUNCH SET FROM 1/8" TO 1-3/16



**16**  
PIECES

Content	
1/8"	5/8"
3/16"	3/4"
1/4"	7/8"
5/16"	1"
3/8"	1-1/16"
7/16"	1-1/8"
1/2"	1 3/16"
9/16"	

**Accessories**  
Handle adapter  
Plastic case



URREA



- Ideal for cutting washers and sealing rings made of foam, cardboard, leather, rubber, fiber, plastic, and thin steel sheet.

ITEM	PIECES	☐	AVAILABLE
49900	16	1	✓

### HOLLOW PUNCH SET FROM 1/8" TO 3/4



**11**  
PIECES

Content	
1/8"	7/16"
3/16"	1/2"
1/4"	9/16"
5/16"	5/8"
3/8"	3/4"

**Accessories**  
Handle adapter  
Plastic case



URREA



- Ideal for cutting washers and sealing rings made of foam, cardboard, leather, rubber, fiber, plastic, and thin steel sheet.

ITEM	PIECES	☐	AVAILABLE
49901	11	1	✓

### HOLLOW PUNCH SET FROM 3 TO 30MM



**16**  
PIECES

Content	
3 mm	16 mm
4 mm	18 mm
6 mm	20 mm
8 mm	22 mm
10 mm	24 mm
12 mm	26 mm
14 mm	30 mm

**Accessories**  
Handle adapter  
Plastic case



URREA



- Ideal for cutting washers and sealing rings made of foam, cardboard, leather, rubber, fiber, plastic, and thin steel sheet.

ITEM	PIECES	☐	AVAILABLE
49900M	16	1	✓

### HOLLOW PUNCH SET FROM 5/8" TO 1-1/4



**7**  
PIECES

External cutting diameter	
5/8"	
3/4"	
1"	
1-1/4"	

**Screws**  
1"  
1-1/2"  
1-3/4"



URREA



- Ground edges that ensure exact diameter holes without burrs.
- Drills through steel sheets up to 2 mm and stainless steel up to 1.5 mm.
- Equipped with a bronze washer that reduces friction and allows smoother cuts.
- Can be operated with a standard wrench.

ITEM	PIECES	☐	AVAILABLE
50900	7	1	On Request

### KNOCKOUT PUNCHES



509-1/2



URREA

- Ground edges that ensure exact diameter holes without burrs
- Drills through steel sheets up to 2 mm and stainless steel up to 1.5 mm.
- Equipped with a bronze washer that reduces friction and allows smoother cuts.
- Can be operated with a standard wrench

ITEM	EXTERNAL CUTTING DIAMETER	BOX	
		☐	AVAILABLE
509-1/2	1/2"	1	✓
509-3/4	3/4"	1	✓
509-7/8	7/8"	1	On Request
509-1	1"	1	✓
509-1-1/4	1-1/4"	1	✓
509-1-1/2	1-1/2"	1	On Request
509-2	2"	1	✓
509-2-1/2	2-1/2"	1	On Request
509-3	3"	1	On Request
509-3-1/2	3-1/2"	1	✓
509-4	4"	1	✓



# NON-SPARKING AND INSULATED TOOLS

# 10

CLASS	TYPE	PAGE	BRAND	
			URREA	SURTEK
Specialty tool sets	1000 V combination tool set	326	•	
	1000 V socket sets with accessories	327	•	
	1000 V adjustable wrenches	328	•	
Insulated tools	1000 V open-end wrenches	328	•	
	1000 V screwdrivers	329	•	•
	1000 V L-type hex keys	331	•	
	1000 V pliers	332	•	•
	1000 V cable stripe knives	333	•	
Non-sparking tools	Non-sparking adjustable wrenches	334	•	
	Non-sparking combination wrenches	334	•	
	Non-sparking spline wrenches	335	•	
	Non-sparking offset striking wrenches	336	•	
	Non-sparking flat striking wrenches	336	•	
	Non-sparking structural box-end wrenches	337	•	
	Non-sparking pipe wrenches	337	•	
	Non-sparking screwdrivers	338	•	
	Non-sparking pliers	338	•	
	Non-sparking chisels	338	•	
	Non-sparking wedges	338	•	
	Non-sparking sledge hammers	339	•	
	Non-sparking ball pein hammers	339	•	
	Non-sparking brushes	340	•	
	Non-sparking putty knives	340	•	

[usa.urrea.com](http://usa.urrea.com)

We are constantly improving our products, that is why the information, characteristics and availability of them can change without prior notice.



# 10 NON-SPARKING AND INSULATED TOOLS

## COMBINATION TOOL SET 1000 V

### SAE COMBINATION TOOL SET 1000V



1000 V

23 PIECES



- Sockets and extension designed with excess polymer to ensure fully insulated assemblies
- The Urrea insulated tool is designed to work safely in activities and operations where there is a risk of contact with live electrical parts of up to 1000V (CA) or 1500V (DC).
- Exceed IEC 60900 Standard

	Opening size	Type	Length	Nut end outside diameter	Drive end outside diameter	Nut depth
Sockets	3/8"	I	3-11/16"	3/4"	1-1/16"	3/4"
	7/16"	I	3-11/16"	55/64"	1-1/16"	3/4"
	1/2"	I	3-11/16"	29/32"	1-1/16"	3/4"
	9/16"	I	3-11/16"	31/32"	1-1/16"	1-1/4"
	5/8"	III	3-11/16"	1-3/32"	1-1/16"	1-1/4"
	3/4"	III	3-11/16"	1-3/16"	1-1/16"	1-7/16"
	7/8"	III	3-11/16"	1-3/8"	1-1/16"	1-3/8"
	15/16"	III	3-11/16"	1-7/16"	1-1/16"	1-3/8"

	Type	Drive	Length	Teeth	Head	Quick Release	Torque resistance
Accessories	Ratchet	1/2"	9-3/16"	48	Pear-Head	•	4,500 lb-in
	Extension	1/2"	5-5/8"	-	-	-	3,500 lb-in
	T-handle	1/2"	8-1/8"	-	-	-	3,500 lb-in

	Length	Jaw length	head thickness	Max. Opening	Jaw thickness	Cable cutting
Pliers	6-1/2"	11/16"	29/32"	1/2"	3/8"	•
	8"	1-19/32"	1-1/16"	1-1/2"	7/16"	•

	Opening size	Total Length	Outside diameter	Head thickness
Open-end wrenches	1/4"	3-1/2"	11/16"	9/32"
	5/16"	4"	3/4"	19/64"
	3/8"	4-1/4"	31/32"	5/16"
	1/2"	4-3/4"	1-1/16"	3/8"
	9/16"	5-1/4"	1-1/4"	13/32"

	Tip type	Shank type	Tip size	Total length	Exposed length
Screwdrivers	⊕ Phillips	Round Shank	3/16"	7-7/8"	3-3/4"
	⊕ Phillips	Round Shank	15/64"	8-1/4"	3-3/4"
	⊖ Plana	Round Shank	7/32"	9-1/4"	4-29/32"
	⊖ Plana	Round Shank	5/32"	7-7/8"	3-15/16"

	Total length	Blade length
Knife	8"	2"

ITEM	PIECES	AVAILABLE
JE23V	23	1 On Request

### METRIC COMBINATION TOOL SET 1000V



1000 V

23 PIECES



- Sockets and extension designed with excess polymer to ensure fully insulated assemblies
- The Urrea insulated tool is designed to work safely in activities and operations where there is a risk of contact with live electrical parts of up to 1000V (CA) or 1500V (DC).
- Exceed IEC 60900 Standard

	Opening size	Type	Length	Nut end outside diameter	Drive end outside diameter	Nut depth
Sockets	10mm	I	3-11/16"	3/4"	1-1/16"	3/4"
	12mm	I	3-11/16"	55/64"	1-1/16"	3/4"
	13mm	I	3-11/16"	29/32"	1-1/16"	3/4"
	14mm	I	3-11/16"	31/32"	1-1/16"	1-1/4"
	17mm	III	3-11/16"	1-3/32"	1-1/16"	1-1/4"
	19mm	III	3-11/16"	1-3/16"	1-1/16"	1-7/16"
	22mm	III	3-11/16"	1-3/8"	1-1/16"	1-3/8"
	24mm	III	3-11/16"	1-7/16"	1-1/16"	1-3/8"

	Type	Drive	Length	Teeth	Head	Quick Release	Torque resistance
Accessories	Ratchet	1/2"	9-3/16"	48	Pear-Head	•	4,500 lb-in
	Extension	1/2"	5-5/8"	-	-	-	3,500 lb-in
	T-handle	1/2"	8-1/8"	-	-	-	3,500 lb-in

	Length	Jaw length	head thickness	Max. Opening	Jaw thickness	Cable cutting
Pliers	6-1/2"	11/16"	29/32"	1/2"	3/8"	•
	8"	1-19/32"	1-1/16"	1-1/2"	7/16"	•

	Opening size	Total Length	Outside diameter	Head thickness
Open-end wrenches	7 mm	3-1/2"	11/16"	9/32"
	8 mm	4"	3/4"	19/64"
	10 mm	4-1/4"	31/32"	5/16"
	12 mm	4-3/4"	1-1/16"	3/8"
	14 mm	5-1/4"	1-1/4"	13/32"

	Tip type	Shank type	Tip size	Total length	Exposed length
Screwdrivers	⊕ Phillips	Round Shank	3/16"	7-7/8"	3-3/4"
	⊕ Phillips	Round Shank	15/64"	8-1/4"	3-3/4"
	⊖ Plana	Round Shank	7/32"	9-1/4"	4-29/32"
	⊖ Plana	Round Shank	5/32"	7-7/8"	3-15/16"

	Total length	Blade length
Knife	8"	2"

ITEM	PIECES	AVAILABLE
JE23VM	23	1 On Request

NON-SPARKING AND INSULATED TOOLS

**URREA**  
SUPERIOR QUALITY AFFORDABLE TOOLS



usa.urrea.com



## 1000 V SOCKET SETS WITH ACCESSORIES

### SAE 1/2" DRIVE 1000 V SOCKET SET WITH ACCESSORIES



**11** VDE  
**PIECES**



- VDE certified product.
- Sockets and extension designed with excess polymer to ensure fully insulated assemblies.
- The Urrea insulated tool is designed and certified to work safely in activities and operations where there is a risk of contact with live electrical parts of up to 1000V (CA) or 1500V (DC).
- Exceed IEC.60900:2004 standard.

	Opening size	Type	Length	Nut end outside diameter	Drive end outside diameter	Nut depth
Sockets	5/16"	I	2-3/64"	43/64"	1-1/16"	7/16"
	3/8"	I	2-5/32"	49/64"	1-1/16"	7/16"
	7/16"	I	2-5/32"	25/32"	1-1/16"	7/16"
	1/2"	II	2-5/32"	1"	1"	7/16"
	9/16"	II	2-5/32"	1"	1"	1/2"
	11/16"	III	2-5/32"	1-5/32"	1-1/8"	1/2"
	3/4"	III	2-5/32"	1-1/4"	1-1/8"	9/16"
	7/8"	III	2-15/64"	1-27/64"	1-3/16"	5/8"
	15/16"	III	2-21/64"	1-17/32"	1-11/32"	25/32"
	Accessories	Ratchet	1/2"	10-3/4"	24	Pear-Head
Extension		1/2"	5-5/8"	-	-	3,500 in-lb
		Drive	Length	Teeth	Head	Quick Release



ITEM	PIECES	AVAILABLE
5400V	11	1 ✓

### METRIC 1/2" DRIVE 1000 V SOCKET SET WITH ACCESSORIES



**11** VDE  
**PIECES**



- VDE certified product.
- Sockets and extension designed with excess polymer to ensure fully insulated assemblies.
- The Urrea insulated tool is designed and certified to work safely in activities and operations where there is a risk of contact with live electrical parts of up to 1000V (CA) or 1500V (DC).
- Exceed IEC.60900:2004 standard.

	Opening size	Type	Length	Nut end outside diameter	Drive end outside diameter	Nut depth
Sockets	8 mm	I	2-5/32"	23/32"	31/32"	1/2"
	10 mm	I	2-5/32"	3/4"	31/32"	1/2"
	11 mm	I	2-5/32"	55/64"	15/16"	1/2"
	13 mm	II	2-5/32"	31/32"	31/32"	1/2"
	14 mm	II	2-5/32"	31/32"	31/32"	1/2"
	17 mm	III	2-5/32"	1-5/32"	1"	1/2"
	19 mm	III	2-5/32"	1-7/32"	1"	9/16"
	22 mm	III	2-5/32"	1-3/8"	1"	19/32"
	24 mm	III	2-11/32"	1-7/16"	1"	43/64"
	Accessories	Ratchet	1/2"	10-3/4"	24	Pear-Head
Extension		1/2"	5-5/8"	-	-	3,500 in-lb
		Drive	Length	Teeth	Head	Quick Release



ITEM	PIECES	AVAILABLE
5400MV	11	1 ✓

### SAE 1/2" DRIVE 1000 V SOCKET SET WITH ACCESSORIES



**11** PIECES



**NEW**

- Sockets and extension designed with excess polymer to ensure fully insulated assemblies.
- The Urrea insulated tool is designed and certified to work safely in activities and operations where there is a risk of contact with live electrical parts of up to 1000V (CA) or 1500V (DC).
- Exceed IEC.60900:2004 standard.

	Opening size	Type	Length	Nut end outside diameter	Drive end outside diameter	Nut depth	
Sockets	3/8"	I	3-11/16"	3/4"	1-1/16"	3/4"	
	7/16"	I	3-11/16"	55/64"	1-1/16"	3/4"	
	1/2"	I	3-11/16"	29/32"	1-1/16"	3/4"	
	9/16"	I	3-11/16"	31/32"	1-1/16"	1-1/4"	
	5/8"	III	3-11/16"	1-3/32"	1-1/16"	1-1/4"	
	3/4"	III	3-11/16"	1-3/16"	1-1/16"	1-7/16"	
	7/8"	III	3-11/16"	1-3/8"	1-1/16"	1-3/8"	
	15/16"	III	3-11/16"	1-7/16"	1-1/16"	1-3/8"	
	Accessories	Ratchet	1/2"	9-3/16"	24	Pear-Head	4,500 in-lb
		Extension	1/2"	5-5/8"	-	-	3,500 in-lb
		Drive	Length	Teeth	Head	Quick Release	Resistance



ITEM	PIECES	AVAILABLE
5400VI	11	1 On Request

### METRIC 1/2" DRIVE 1000 V SOCKET SET WITH ACCESSORIES



**11** PIECES



**NEW**

- Sockets and extension designed with excess polymer to ensure fully insulated assemblies.
- The Urrea insulated tool is designed and certified to work safely in activities and operations where there is a risk of contact with live electrical parts of up to 1000V (CA) or 1500V (DC).
- Exceed IEC.60900:2004 standard.

	Opening size	Type	Length	Nut end outside diameter	Drive end outside diameter	Nut depth	
Sockets	10mm	I	3-11/16"	3/4"	1-1/16"	3/4"	
	12mm	I	3-11/16"	55/64"	1-1/16"	3/4"	
	13mm	I	3-11/16"	29/32"	1-1/16"	3/4"	
	14mm	I	3-11/16"	31/32"	1-1/16"	1-1/4"	
	17mm	III	3-11/16"	1-3/32"	1-1/16"	1-1/4"	
	19mm	III	3-11/16"	1-3/16"	1-1/16"	1-7/16"	
	22mm	III	3-11/16"	1-3/8"	1-1/16"	1-3/8"	
	24mm	III	3-11/16"	1-7/16"	1-1/16"	1-3/8"	
	Accessories	Ratchet	1/2"	9-3/16"	24	Pear-Head	4,500 in-lb
		Extension	1/2"	5-5/8"	-	-	3,500 in-lb
		Drive	Length	Teeth	Head	Quick Release	Resistance



ITEM	PIECES	AVAILABLE
5400MVI	11	1 On Request

## 1000 V ADJUSTABLE WRENCHES

### 1000 V ADJUSTABLE WRENCHES

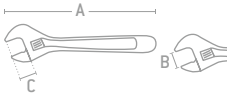

712V

- Made of chrome vanadium steel.
- Exceed IEC 60900:2004 standard.
- Double insulated handle with non-slip protectors.

ITEM	TOTAL LENGTH (A)	MAXIMUM OPENING (B)	JAW DEPTH (C)	📦	AVAILABLE
708V	8"	1"	1"	1	✓
710V	10"	1-1/8"	1-1/8"	1	✓
712V	12"	1-5/16"	1-5/16"	1	✓
715V	15"	1-11/16"	1-5/8"	1	✓

### SAE 1000 V OPEN-END WRENCHES



NEW



1210V

- Made of chrome vanadium steel alloy
- Double insulated handle
- Exceed IEC 60900 Standard

ITEM	OPENING SIZE	TOTAL LENGTH	OUTER DIAMETER	HEAD THICKNESS	📦	AVAILABLE	WRENCH SET
1210V	5/16"	3-47/64"	55/64"	9/32"	1	On Request	1201V
1212V	3/8"	3-15/16"	1-1/32"	19/64"	1	On Request	8
1214V	7/16"	4-13/32"	1-5/32"	5/16"	1	On Request	
1216V	1/2"	5-13/64"	1-11/32"	21/64"	1	On Request	
1218V	9/16"	5-33/64"	1-11/32"	21/64"	1	On Request	
1220V	5/8"	6-1/16"	1-17/32"	23/64"	1	On Request	
1222V	11/16"	6-3/16"	1-43/64"	23/64"	1	On Request	
1225V	3/4"	6-11/16"	1-47/64"	23/64"	1	On Request	

### METRIC 1000 V OPEN-END WRENCHES



NEW



1210VM

- Made of chrome vanadium steel alloy
- Double insulated handle
- Exceed IEC 60900 Standard

ITEM	OPENING SIZE	TOTAL LENGTH	OUTER DIAMETER	HEAD THICKNESS	📦	AVAILABLE	WRENCH SET
1210VM	10 mm	4-9/64"	1-1/32"	19/64"	1	On Request	1201VM
1211VM	11 mm	4-13/32"	1-1/32"	19/64"	1	On Request	9
1212VM	12 mm	4-59/64"	1-9/64"	5/16"	1	On Request	
1213VM	13 mm	5-13/64"	1-17/64"	21/64"	1	On Request	
1214VM	14 mm	5-33/64"	1-17/64"	21/64"	1	On Request	
1215VM	15 mm	5-29/32"	1-27/64"	23/64"	1	On Request	
1217VM	17 mm	6-3/16"	1-39/64"	25/64"	1	On Request	
1218VM	18 mm	6-1/2"	1-11/16"	7/16"	1	On Request	
1219VM	19 mm	6-11/16"	1-47/64"	7/16"	1	On Request	

NON-SPARKING AND INSULATED TOOLS

1000 V SCREWDRIVERS

# TRIMATERIAL SCREWDRIVERS

**DIELECTRIC** **1000 V** **TRIMATERIAL HANDLE**

## TRIMATERIAL HANDLE

Tip machined with exact tolerances.



The handle integrates a diamond-patterned area for better hand grip and ventilation between hand and handle.

Greater torque power, due to its trilobal design.

- Red PP plastic: prevents shaft slippage.
- Gray soft TPE material: better transmission of torque.
- Black PP plastic: impact-resistant and low temperatures resistant.

**DIN ISO Standard** Insulation directly injection molded around the bar for maximum electrical protection.

1000 V TRIMATERIAL SLIM SCREWDRIVER SET

**SUPER DUTY** **DIELECTRIC** **1000 V VDE**



Tip	Tip size
⊖ Slotted	3.5 mm, 4 mm, 5.5 mm
⊕ Phillips®	PH 1, PH 2

- VDE certified product.
- Thanks to its slim design, the tip can enter without restriction into narrow cavities of switches and other electrical devices.
- Exceed IEC.60900:2004 standard.

ITEM	PIECES	AVAILABLE
9700TSA	5	1 ✓

1000 V TRIMATERIAL SCREWDRIVERS

**SUPER DUTY** **DIELECTRIC** **1000 V VDE**

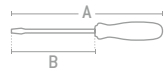

- The handle integrates a diamond-patterned area for greater hand grip and ventilation between hand and handle.
- Greater torque power due to its trilobal design at the top of the handle.
- PP plastic specially formulated to resist impacts, even at very low temperatures.
- TPE soft rubber formulated to transmit better torque.
- Exceed IEC.60900:2004 standard.

ITEM	SHANK TYPE	TIP TYPE	TIP SIZE	TOTAL LENGTH (A)	EXPOSED LENGTH (B)	AVAILABLE
9713T	Round shank	⊖	3/32"	6-19/64"	3"	1 ✓
9714T	Round shank	⊖	5/32"	7-9/32"	4"	1 ✓
9715T	Round shank	⊖	7/32"	8-55/64"	5"	1 ✓
9716T	Round shank	⊖	1/4"	10-15/64"	6"	1 <b>On Request</b>
9700T	Round shank	⊕	PH 0	5-45/64"	2-3/8"	1 ✓
9701T	Round shank	⊕	PH 1	7-3/32"	3-5/32"	1 ✓
9702T	Round shank	⊕	PH 2	8-17/64"	4"	1 ✓
9703T	Round shank	⊕	PH 3	10-5/8"	6"	1 ✓

1000 V TRIMATERIAL NUT DRIVERS

**SUPER DUTY** **DIELECTRIC** **1000 V VDE**

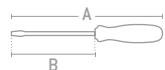

- The handle integrates a diamond-patterned area for greater hand grip and ventilation between the hand and the handle.
- Greater torque power due to its trilobal design at the top of the handle.
- PP plastic specially formulated to resist impacts, even at very low temperatures.
- TPE soft rubber formulated to transmit better torque.
- Exceed IEC.60900:2004 standard

ITEM	SHANK TYPE	NUT SIZE	OPENING SIZE	TOTAL LENGTH (A)	EXPOSED LENGTH (B)	AVAILABLE
9206TV	Round shank	⊙	3/16"	9"	5"	1 <b>On Request</b>
9208TV	Round shank	⊙	1/4"	9"	5"	1 ✓
9206MTV	Round shank	⊙	- 6 mm	9"	5"	1 <b>On Request</b>
9207MTV	Round shank	⊙	- 7 mm	9"	5"	1 ✓
9208MTV	Round shank	⊙	- 8 mm	9"	5"	1 <b>On Request</b>
9209MTV	Round shank	⊙	- 9 mm	9"	5"	1 <b>On Request</b>
9210MTV	Round shank	⊙	- 10 mm	9"	5"	1 <b>On Request</b>
9211MTV	Round shank	⊙	- 11 mm	9"	5"	1 <b>On Request</b>

# 10 NON-SPARKING AND INSULATED TOOLS

## 1000 V SCREWDRIVERS

### 1000 V INTERCHANGEABLE BIT SCREWDRIVER SET



**10**  
PIECES

Type	Tips	Exposed length	Pieces
Slotted	1/8"	60 mm	1
	5/32"	100 mm	1
	3/16"	100 mm	1
	1/4"	100 mm	1
Phillips®	PH 1	80 mm	1
	PH 2	100 mm	1
Torx®	T15	100 mm	1
	T20	100 mm	1
Handles			2
Pouch			1



- 8-interchangeable bits make it a very versatile set
- Includes two kind of handles, one for high torque applications, other for precision uses.
- Exceeds IEC-60900 standard.



VIDEO



ITEM	PIECES	AVAILABLE
9300V	10	✓

### 1000 V BIMATERIAL HANDLE SCREWDRIVER SET



**7**  
PIECES



- Greater torque capacity thanks to its trilobular handle design.
- Soft TPE-type plastic for better grip.
- Blackened tip to prevent chrome peeling.
- Exceed IEC 60900 Standard

Type	Tips	Exposed length	Pieces
Phillips®	PH0	2-15/16"	1
	PH1	3-15/16"	1
	PH2	3-15/16"	1
Slotted	3 mm	2-15/16"	1
	4 mm	3-15/16"	1
	5.5 mm	4-29/32"	1
	6.5 mm	5-29/32"	1

ITEM	PIECES	AVAILABLE
9700BV	7	On Request

### 1000 V BIMATERIAL HANDLE SCREWDRIVER SET



**6**  
PIECES



- PP+TPR Bi-material handle.
- Blade in chrome vanadium.
- 1000 V BIMATERIAL SCREWDRIVERS.
- Shank is fully protected.
- Exceeds ASME B107.600 standard.

Type	Tips	Pieces
Slotted	1.0 x 5.5 x 125 mm	1
	0.8 x 4.0 x 100 mm	1
	0.4 x 2.5 x 75 mm	1
Phillips®	PH2 x 100 mm	1
	PH1 x 80 mm	1
	PH0 x 60 mm	1

ITEM	PIECES	AVAILABLE
JDB6V	6	On Request

### 1000 V BIMATERIAL SCREWDRIVERS



- Trilobular design for best torque transmission.
- Red plastic torsion and impact resistant PP type.
- Black plastic TPE type of soft rubber for better grip.
- Black tip to avoid detachment of chrome.
- Exceed IEC.60900:2004 standard.

ITEM	SHANK	TIP TYPE	TIP SIZE	TOTAL LENGTH (A)	EXPOSED LENGTH (B)	AVAILABLE
9713B	Round shank	⊖	3/32"	6"	3"	✓
9714B	Round shank	⊖	5/32"	7-1/2"	4"	✓
9715B	Round shank	⊖	7/32"	8-7/8"	5"	✓
9716B	Round shank	⊖	1/4"	9-7/8"	5-7/8"	✓
9700B	Round shank	⊕	PH 0	5-1/2"	2-3/8"	✓
9701B	Round shank	⊕	PH 1	7"	3-5/32"	✓
9702B	Round shank	⊕	PH 2	7-7/8"	3-15/16"	✓

ITEM	PIECES	AVAILABLE
9700BA	7	✓

ITEM	PIECES	AVAILABLE
9700BA	7	✓

NON-SPARKING AND INSULATED TOOLS

**1000 V SCREWDRIVERS**

**1000 V R-SERIES SCREWDRIVERS**



URREA



- Trilobular design for best torque transmission.
- Black tip to avoid chrome detachment.
- Handle made of impact and torsion resistant PP plastic.
- Exceed IEC.60900:2004 standard.

ITEM	SCREWDRIVER SETS	
	J9700V	9700C
PIECES	8	5
PACKING		
AVAILABLE	1	1
ITEM	✓	✓
PIECES	•	•
PACKING	•	•
AVAILABLE	On Request	•
ITEM	•	•
PIECES	•	•
PACKING	•	•
AVAILABLE	•	•

ITEM	SHANK	TIP TYPE	TIP SIZE	TOTAL LENGTH (A)	EXPOSED LENGTH (B)	AVAILABLE
9713	Round shank	⊖	3/32"	6"	3"	✓
9713A	Round shank	⊖	1/8"	6"	3"	✓
9714	Round shank	⊖	5/32"	7-1/2"	4"	✓
9715	Round shank	⊖	7/32"	8-7/8"	5"	On Request
9716	Round shank	⊖	1/4"	9-7/8"	5-7/8"	✓
9700	Round shank	⊕	PH 0	5-1/2"	2-3/8"	✓
9701	Round shank	⊕	PH 1	7"	3-5/32"	✓
9702	Round shank	⊕	PH 2	7-7/8"	3-15/16"	✓

**1000 V SCREWDRIVERS**



SURTEK



- Made of high-resistance PP plastic.
- Blackened tip to prevent chrome peeling.
- Exceeds IEC-60900 standard.

ITEM	SCREWDRIVER SETS	
	D4VC	D4V
PIECES	5	5
PACKING		
AVAILABLE	6	1
ITEM	On Request	✓
PIECES	•	•
PACKING	•	•
AVAILABLE	•	•

ITEM	SHANK	TIP TYPE	TIP SIZE	TOTAL LENGTH (A)	EXPOSED LENGTH (B)	AVAILABLE
D401V	Round shank	⊕	PH 1	7"	3-1/8"	✓
D402V	Round shank	⊕	PH 2	8"	4"	✓
D414V	Round shank	⊖	5/32"	8"	4"	✓
D415V	Round shank	⊖	7/32"	9"	5"	✓
D416V	Round shank	⊖	1/4"	9-11/16"	5-7/8"	✓

**1000 V L-TYPE HEX KEYS**



URREA



URREA



49-3/16V



49-5V

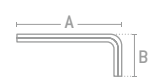

- Made of chrome vanadium steel alloy.
- Handle with double insulated dipping plastic.
- Exceed IEC 60900 Standard.

HEX KEY SET	
ITEM	4901V
PIECES	4
PACKING	
AVAILABLE	1

ITEM	TIP SIZE	TOTAL LENGTH (A)	SHANK LENGTH (B)	AVAILABLE
49-1/8V	1/8"	5-5/64"	63/64"	On Request
49-5/32V	5/32"	5-43/64"	1-7/32"	On Request
49-3/16V	3/16"	6-1/2"	1-3/8"	On Request
49-1/4V	1/4"	7-21/64"	1-37/64"	On Request

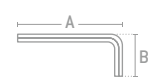

- Made of chrome vanadium steel alloy.
- Handle with double insulated dipping plastic.
- Exceed IEC 60900 Standard.

HEX KEY SET	
ITEM	4901VM
PIECES	4
PACKING	
AVAILABLE	1

ITEM	TIP SIZE	TOTAL LENGTH (A)	SHANK LENGTH (B)	AVAILABLE
49-3V	3 mm	5-1/8"	1-1/32"	On Request
49-4V	4 mm	5-45/64"	1-7/32"	On Request
49-5V	5 mm	6-1/2"	1-27/64"	On Request
49-6V	6 mm	7-13/32"	1-37/64"	On Request

NON-SPARKING AND INSULATED TOOLS

## 1000 V PLIERS

### 1000 V PLIERS

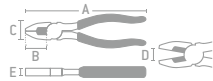

- Made of chrome vanadium steel.
- PVC handle to avoid fire hazard and conductivity.
- Double insulated handle with non-slip protectors
- They allow working in reduced areas facilitating handling, cutting or braiding of energized cables.
- Exceed IEC 60900:2004 standard.

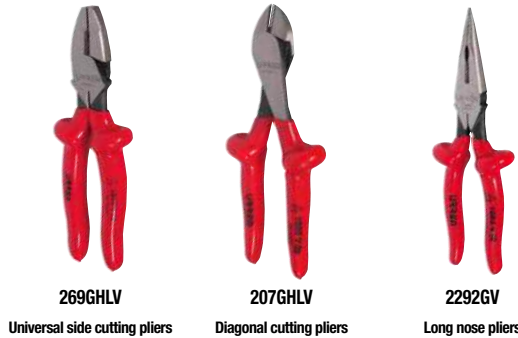

ITEM	TOTAL LENGTH (A)	JAW LENGTH (B)	JAW WIDTH (C)	MAX OPENING (D)	JAW DEPTH	CUTS WIRE	CUTTING TYPE	CUTTING EDGE	⊞	AVAILABLE
269GHLV	9-1/2"	1-3/4"	1-9/32"	1-7/32"	5/8"	✓	Side cutting	25/32"	3	On Request
207GHLV	7-15/16"	1-5/32"	1-5/32"	27/32"	1/2"	✓	Diagonal cutting	13/16"	3	On Request
2292GV	8-9/32"	2-3/4"	1-1/32"	1-1/2"	33/64"	✓	Side cutting	19/32"	3	On Request

### 1000 V PLIERS BIMATERIAL HANDLE

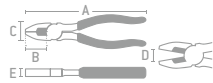

- VDE certified product.
- Made of chrome vanadium steel alloy.
- Bimaterial handle with non-slip protectors.
- Exceed IEC 60900 standard.



ITEM	TOTAL LENGTH (A)	JAW LENGTH (B)	JAW WIDTH (C)	MAX OPENING (D)	JAW DEPTH (E)	CUTS WIRE	CUTTING TYPE	CUTTING EDGE	⊞	AVAILABLE
180	6-5/16"	3/8"	13/16"	1-7/32"	25/64"	✓	Side cutting	15/32"	1	✓
181	7-5/16"	9/16"	1"	1-5/16"	7/16"	✓	Side cutting	5/8"	1	✓
189	6-11/16"	1-5/8"	11/16"	1-5/16"	23/64"	✓	Diagonal cutting	9/16"	1	On Request
183	7-7/8"	1-7/64"	1-13/32"	11/16"	29/64"	✓	Diagonal cutting	55/64"	1	✓
182	7"	1"	1-1/4"	19/32"	7/16"	✓	Diagonal cutting	25/32"	1	✓
187	7-7/8"	2-7/8"	11/16"	1-23/64"	11/32"	✓	Diagonal cutting	9/16"	1	✓

### 1000 V PLIERS BIMATERIAL HANDLE

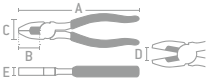

- Made of chrome vanadium steel alloy.
- Bimaterial handle with non-slip protectors.
- Exceed IEC 60900 Standard.



ITEM	TOTAL LENGTH (A)	JAW LENGTH (B)	JAW WIDTH (C)	MAX OPENING (D)	CUTS WIRE	CUTTING TYPE	CUTTING EDGE	CUTTING CAPACITY	⊞	AVAILABLE
967V	7"	37 mm	13/32"	1-3/8"	✓	Lateral cutting	33/64"	Medium wire	6	On Request
968V	8"	1-59/64"	7/16"	1-17/32"	✓	Lateral cutting	23/64"	Medium wire	6	On Request
946V	6"	29/32"	3/8"	29/32"	✓	Diagonal cutting	5/64"	Medium wire	6	On Request
926V	6"	1-27/32"	23/64"	1-27/64"	✓	Lateral cutting	15/32"	Medium wire	6	On Request
928V	8"	2-33/64"	23/64"	2-51/64"	✓	Lateral cutting	33/64"	Medium wire	6	On Request

**1000 V PLIERS**

**1000 V GROOVE JOINT PLIER**



- Made of chrome vanadium steel alloy.
- Double insulated handle with non-slip protectors.
- 7-position adjustment for easy configuration.
- Exceed IEC 60900 Standard.



ITEM	TOTAL LENGTH	JAW LENGTH	JAW WIDTH	MAX OPENING	☐	AVAILABLE
270V	9-29/64"	1-3/8"	17/32"	1-19/64"	1	On Request

**1000 V WIRE AND CABLE CUTTER**



For copper cable AWG 1/0

- Double insulated handle with non-slip protectors.
- High leverage.
- For cutting cooper cables or wires.
- Exceed IEC 60900 Standard.



ITEM	TOTAL LENGTH	JAW LENGTH	JAW WIDTH	MAX OPENING	☐	AVAILABLE
289GV	9-1/4"	1-5/8"	1-9/16"	1-37/64"	1	On Request

**1000 V TWEEZER PLIERS**



PPR1V

- Double insulated handle with non-slip protectors.
- Exceed IEC 60900 Standard.



ITEM	TOTAL LENGTH	BLADE LENGTH	☐	AVAILABLE
PPR1V	6-1/2"	29/32"	1	On Request
PPR2V	5-9/32"	55/64"	1	On Request

**1000 V CABLE STRIPE KNIFES**



NELV



NELCV

- Double insulated handle with non-slip protectors.
- Includes blade protector.
- Exceed IEC 60900.



ITEM	TOTAL LENGTH	BLADE LENGTH	HANDLE LENGTH	☐	AVAILABLE
NELV	7-3/32"	1-37/64"	4-59/64"	1	On Request
NELCV	8-21/32"	2-1/4"	5-1/8"	1	On Request

## NON-SPARKING TOOLS

Urrea non-sparking tools are the ideal tool for use in applications in potentially explosive environments.

All tools are forged from an aluminum-bronze alloy, which allows them to meet the performance requirements without creating sparks



The bronze-aluminum alloy gives special properties as anti-spark, anti-magnetic and corrosion resistance



## NON-SPARKING ADJUSTABLE WRENCHES

### NON-SPARKING ADJUSTABLE WRENCHES



UH708

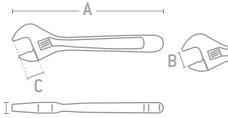

Tools recommended for 1, 2, 21 or 22 Ex zones.

ITEM	TOTAL LENGTH (A)	MAX OPENING (B)	THROAT DEPTH (C)	JAW THICKNESS (D)	AVAILABLE
UH708	8"	11/16"	11/16"	25/32"	1 On Request
UH710	10"	15/16"	15/16"	25/32"	1 On Request
UH712	12"	1-3/8"	1-1/8"	25/32"	1 On Request
UH715	15"	1-13/16"	1-5/8"	1-7/64"	1 On Request
UH718	18"	2-5/32"	2"	1-7/64"	1 On Request
UH724	24"	2-1/2"	2-3/8"	1-11/32"	1 On Request

## NON-SPARKING COMBINATION WRENCHES

### SAE NON-SPARKING COMBINATION 12-POINT WRENCHES



UH1224

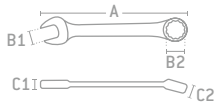

Tools recommended for 1, 2, 21 or 22 Ex zones.  
 Slim jaws for better access in tight areas.  
 Oval body for a more comfortable grip.



\* POUCH

ITEM	OPENING SIZE	TOTAL LENGTH (A)	OUTSIDE DIAMETER (B)		HEAD THICKNESS		AVAILABLE	WRENCH SETS		
			OPEN END (B1)	BOX END (B3)	OPEN END (C1)	BOX END (C2)		UH1200F*	UH1200G*	UH1200H*
UH1210	5/16"	5-9/16"	11/16"	35/64"	1/4"	13/64"	1 On Request	•		
UH1212	3/8"	6"	13/16"	19/32"	5/16"	7/32"	1 ✓	•		•
UH1214	7/16"	6-1/2"	15/16"	11/16"	5/16"	1/4"	1 ✓	•		•
UH1216	1/2"	7"	1-3/64"	25/32"	11/32"	17/64"	1 ✓	•	•	•
UH1218	9/16"	7-1/2"	1-13/64"	7/8"	23/64"	9/32"	1 ✓	•	•	•
UH1220	5/8"	8-1/8"	1-21/64"	31/32"	25/64"	5/16"	1 ✓	•	•	•
UH1222	11/16"	8-15/16"	1-29/64"	1-3/64"	27/64"	21/64"	1 ✓	•	•	•
UH1224	3/4"	9-13/16"	1-9/16"	1-7/64"	29/64"	21/64"	1 ✓	•	•	•
UH1226	13/16"	10-11/16"	1-11/16"	1-7/32"	31/64"	3/8"	1 ✓	•	•	•
UH1228	7/8"	11-9/16"	1-51/64"	1-5/16"	33/64"	25/64"	1 ✓	•	•	•
UH1230	15/16"	12-7/16"	1-29/32"	1-13/32"	35/64"	13/32"	1 ✓	•	•	•
UH1232	1"	13-5/16"	2"	1-1/2"	37/64"	7/16"	1 ✓	•	•	•
UH1234	1-1/16"	14-13/64"	2-9/64"	1-5/8"	39/64"	29/64"	1 ✓	•		
UH1236	1-1/8"	15-15/32"	2-17/64"	1-45/64"	5/8"	15/32"	1 ✓	•		
UH1238	1-3/16"	20-6/16"	2-17/64"	1-45/64"	5/8"	15/32"	1 On Request			
UH1240	1-1/4"	16-7/8"	2-33/64"	1-7/8"	11/16"	33/64"	1 ✓	•		
UH1244	1-3/8"	18-5/8"	2-49/64"	2-1/32"	49/64"	9/16"	1 ✓			
UH1246	1-7/16"	19-15/32"	2-57/64"	2-9/64"	13/16"	9/16"	1 ✓			
UH1248	1-1/2"	20-1/4"	3"	2-3/16"	27/32"	39/64"	1 On Request			
UH1250	1-9/16"	23"	3-25/64"	2-13/32"	29/32"	21/32"	1 ✓			
UH1252	1-5/8"	23-1/8"	3-25/64"	2-13/32"	29/32"	21/32"	1 ✓			
UH1254	1-11/16"	23-1/8"	3-25/64"	2-13/32"	29/32"	21/32"	1 ✓			
UH1256	1-3/4"	23-1/8"	3-41/64"	2-43/64"	31/32"	45/64"	1 ✓			
UH1258	1-13/16"	25-7/64"	3-41/64"	2-43/64"	31/32"	45/64"	1 ✓			
UH1260	1-7/8"	28"	3-57/64"	3"	63/64"	23/32"	1 ✓			

NON-SPARKING AND INSULATED TOOLS



**NON-SPARKING COMBINATION WRENCHES**

**METRIC NON-SPARKING 12-POINT COMBINATION WRENCHES**



UH1224M

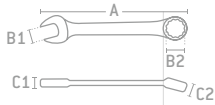

- Tools recommended for 1, 2, 21 or 22 Ex zones.
- Oval body for a more comfortable grip.
- Precision machined jaws for a perfect coupling with the nut or bolt.



ITEM	WRENCH SETS			ITEM	PIECES	PACKING	AVAILABLE
	UH1200QM*	UH1200FM*	UH1200KM*				
	26	15	10				
	1	1	1				
ITEM	OPENING SIZE	TOTAL LENGTH (A)	OUTSIDE DIAMETER (B)		HEAD THICKNESS		AVAILABLE
			OPEN END (B1)	BOX END (B2)	OPEN END (C1)	BOX END (C2)	
UH1206M	6 mm	5-1/16"	5/8"	13/32"	15/64"	3/16"	✓
UH1207M	7 mm	5-1/16"	5/8"	13/32"	15/64"	3/16"	✓
UH1208M	8 mm	5-9/16"	11/16"	35/64"	1/4"	13/64"	✓
UH1209M	9 mm	6-1/16"	13/16"	19/32"	5/16"	7/32"	✓
UH1210M	10 mm	6-9/16"	15/16"	11/16"	5/16"	1/4"	✓
UH1211M	11 mm	6-9/16"	15/16"	11/16"	5/16"	1/4"	✓
UH1212M	12 mm	7-1/16"	1-3/64"	25/32"	11/32"	17/64"	✓
UH1213M	13 mm	7-1/16"	1-3/64"	25/32"	11/32"	17/64"	✓
UH1214M	14 mm	7-9/16"	1-13/64"	7/8"	23/64"	9/32"	✓
UH1215M	15 mm	7-9/16"	1-13/64"	7/8"	23/64"	9/32"	✓
UH1216M	16 mm	8-2/16"	1-21/64"	31/32"	25/64"	5/16"	✓
UH1217M	17 mm	8-15/16"	1-29/64"	1-3/64"	27/64"	21/64"	✓
UH1218M	18 mm	8-15/16"	1-29/64"	1-3/64"	27/64"	21/64"	✓
UH1219M	19 mm	9-13/16"	1-9/16"	1-7/64"	29/64"	21/64"	✓
UH1220M	20 mm	10-11/16"	1-11/16"	1-7/32"	31/64"	3/8"	✓
UH1221M	21 mm	10-11/16"	1-11/16"	1-7/32"	31/64"	3/8"	✓
UH1222M	22 mm	11-9/16"	1-51/64"	1-5/16"	33/64"	25/64"	✓
UH1223M	23 mm	11-9/16"	1-51/64"	1-5/16"	33/64"	25/64"	✓
UH1224M	24 mm	12-7/16"	1-29/32"	1-13/32"	35/64"	13/32"	✓
UH1225M	25 mm	12-7/16"	1-29/32"	1-13/32"	35/64"	13/32"	✓
UH1226M	26 mm	13-5/16"	2"	1-1/2"	37/64"	7/16"	✓
UH1227M	27 mm	14-3/16"	2-9/64"	1-5/8"	39/64"	29/64"	✓
UH1228M	28 mm	15-1/2"	2-17/64"	1-45/64"	5/8"	15/32"	✓
UH1229M	29 mm	15-1/2"	2-17/64"	1-45/64"	5/8"	15/32"	✓
UH1230M	30 mm	15-1/2"	2-17/64"	1-45/64"	5/8"	15/32"	✓
UH1232M	32 mm	16-14/16"	2-33/64"	1-7/8"	11/16"	33/64"	On Request
UH1233M	33 mm	17-11/16"	2-41/64"	1-61/64"	3/4"	35/64"	✓
UH1234M	34 mm	17-11/16"	2-41/64"	1-61/64"	3/4"	35/64"	✓
UH1237M	37 mm	19-7/16"	2-57/64"	2-9/64"	13/16"	9/16"	✓
UH1238M	38 mm	20-6/16"	3"	2-3/16"	27/32"	39/64"	✓
UH1241M	41 mm	23-2/16"	3-25/64"	2-13/32"	29/32"	21/32"	✓
UH1242M	42 mm	23-2/16"	3-25/64"	2-13/32"	29/32"	21/32"	On Request
UH1246M	46 mm	28"	3-41/64"	2-43/64"	31/32"	45/64"	✓
UH1250M	50 mm	28"	3-57/64"	3"	63/64"	23/32"	✓
UH1251M	51 mm	28"	3-57/64"	3"	63/64"	23/32"	✓

NON-SPARKING AND INSULATED TOOLS

**NON-SPARKING SPLINE WRENCHES**

**SAE NON-SPARKING 12-POINT 15° BOX-END WRENCHES**



UH1134



- Precision machined jaws for a perfect coupling with the nut or bolt.
- Slim jaws for better access in tight areas.
- Tools recommended for 1, 2, 21 or 22 Ex zones.



ITEM	OPENING SIZE	TOTAL LENGTH (A)	OUTER DIAMETER		HEAD THICKNESS		AVAILABLE
			(B1)	(B2)	(C1)	(C1)	
UH1164	1-5/8" x 1-11/16"	24-1/2"	2-3/8"	2-25/64"	7/8"	61/64"	On Request

## NON-SPARKING OFFSET STRIKING WRENCHES

### SAE NON-SPARKING OFFSET STRIKING WRENCHES



UH2629SW

- Tools recommended for 1, 2, 21 or 22 Ex zones.
- Urrea offset striking wrenches, with the opening at an angle from the wrench's shank, allows them to be used in places with obstacles hindering their operation.

ITEM	OPENING SIZE	TOTAL LENGTH (A)	OUTER DIAMETER (B)	HEAD DEPTH (C)	⊞	AVAILABLE
UH2616SW	1"	8-1/2"	1-11/16"	5/8"	1	✓
UH2617SW	1-1/16"	8-1/2"	1-11/16"	5/8"	1	✓
UH2618SW	1-1/8"	8-1/2"	1-11/16"	5/8"	1	On Request
UH2619SW	1-3/16"	10-3/4"	1-7/8"	13/16"	1	✓
UH2620SW	1-1/4"	10-3/4"	1-7/8"	13/16"	1	✓
UH2621SW	1-5/16"	10-3/4"	1-7/8"	13/16"	1	On Request
UH2622SW	1-3/8"	12"	2-3/16"	1"	1	✓
UH2623SW	1-7/16"	12"	2-3/16"	1"	1	On Request
UH2624SW	1-1/2"	12"	2-3/16"	1"	1	✓
UH2627SW	1-11/16"	12-1/4"	2-13/32"	1-1/8"	1	✓
UH2628SW	1-3/4"	13-7/16"	2-21/32"	1-13/16"	1	✓
UH2629SW	1-13/16"	13-5/8"	2-61/64"	1-1/4"	1	✓
UH2630SW	1-7/8"	13-5/8"	2-61/64"	1-1/4"	1	✓
UH2631SW	1-15/16"	13-5/8"	2-61/64"	1-1/4"	1	✓
UH2632SW	2"	14-1/8"	3-3/16"	1-1/4"	1	✓

### METRIC NON-SPARKING OFFSET STRIKING WRENCHES

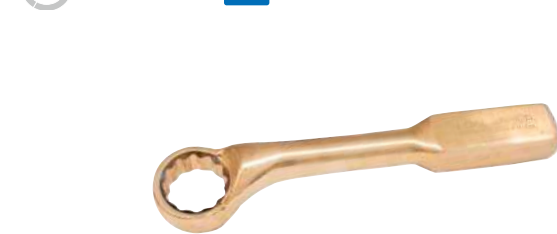

US2633WM

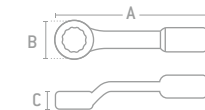

- Tools recommended for 1, 2, 21 or 22 Ex zones.
- Urrea offset striking wrenches, with the opening at an angle from the wrench's shank, allows them to be used in places with obstacles hindering their operation.

ITEM	OPENING SIZE	TOTAL LENGTH (A)	OUTER DIAMETER (B)	HEAD DEPTH (C)	⊞	AVAILABLE
UH2633SWM	33 mm	10-3/4"	1-7/8"	13/16"	1	✓
UH2650SWM	50 mm	13-7/16"	2-27/32"	1-1/4"	1	✓

## NON-SPARKING FLAT STRIKING WRENCHES

### SAE NON-SPARKING FLAT STRIKING WRENCHES



UH2729SW

- Tools recommended for 1, 2, 21 or 22 Ex zones
- The flat desing allows it to be used in places where there is no object or obstacle in its way.

ITEM	OPENING SIZE	TOTAL LENGTH (A)	OUTER DIAMETER (B)	HEAD DEPTH (C)	⊞	AVAILABLE
UH2716SW	1"	9-1/2"	2-15/64"	55/64"	1	✓
UH2717SW	1-1/16"	9-1/2"	2-15/64"	55/64"	1	✓
UH2718SW	1-1/8"	9-1/2"	2-15/64"	55/64"	1	✓
UH2719SW	1-3/16"	9-1/2"	2-15/64"	55/64"	1	✓
UH2720SW	1-1/4"	9-1/2"	2-15/64"	55/64"	1	✓
UH2721SW	1-5/16"	9-1/2"	2-15/64"	55/64"	1	✓
UH2722SW	1-3/8"	9-1/2"	2-15/64"	55/64"	1	✓
UH2723SW	1-7/16"	11-21/64"	3"	63/64"	1	✓
UH2724SW	1-1/2"	11-21/64"	3"	63/64"	1	✓
UH2726SW	1-5/8"	11-21/64"	3"	63/64"	1	✓
UH2727SW	1-11/16"	11-21/64"	3"	63/64"	1	✓
UH2728SW	1-3/4"	11-21/64"	3"	63/64"	1	✓
UH2729SW	1-13/16"	11-21/64"	3"	63/64"	1	✓
UH2730SW	1-7/8"	11-21/64"	3"	63/64"	1	✓
UH2731SW	1-15/16"	11-21/64"	3"	63/64"	1	✓
UH2732SW	2"	13-31/64"	3-47/64"	1-31/64"	1	✓
UH2734SW	2-1/8"	13-31/64"	3-47/64"	1-31/64"	1	✓
UH2735SW	2-3/16"	13-31/64"	3-47/64"	1-31/64"	1	✓
UH2736SW	2-1/4"	13-31/64"	3-47/64"	1-31/64"	1	✓
UH2737SW	2-5/16"	13-31/64"	3-47/64"	1-31/64"	1	✓
UH2738SW	2-3/8"	14-51/64"	4-7/64"	1-31/64"	1	✓
UH2740SW	2-1/2"	14-51/64"	4-7/64"	1-31/64"	1	✓
UH2741SW	2-9/16"	14-51/64"	4-7/64"	1-31/64"	1	✓
UH2742SW	2-5/8"	14-51/64"	4-7/64"	1-31/64"	1	✓
UH2744SW	2-3/4"	16-18/47"	4-9/16"	1-19/32"	1	✓
UH2746SW	2-7/8"	16-18/47"	4-9/16"	1-19/32"	1	✓
UH2747SW	2-15/16"	16-18/47"	4-9/16"	1-19/32"	1	✓
UH2748SW	3"	16-18/47"	4-9/16"	1-19/32"	1	✓
UH2750SW	3-1/8"	18-27/68"	5-1/8"	1-23/32"	1	✓
UH2754SW	3-3/8"	18-27/68"	5-1/8"	1-23/32"	1	✓
UH2756SW	3-1/2"	18-27/68"	5-1/8"	1-23/32"	1	✓

### METRIC NON-SPARKING FLAT STRIKING WRENCHES



UH2730SWM

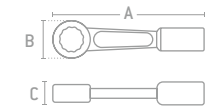

- Tools recommended for 1, 2, 21 or 22 Ex zones
- The flat desing allows it to be used in places where there is no object or obstacle in its way.

ITEM	OPENING SIZE	TOTAL LENGTH (A)	OUTER DIAMETER (B)	HEAD DEPTH (C)	⊞	AVAILABLE
UH2724SWM	24 mm	9-1/2"	2-15/64"	55/64"	1	✓
UH2727SWM	27 mm	9-1/2"	2-15/64"	55/64"	1	✓
UH2730SWM	30 mm	9-1/2"	2-15/64"	55/64"	1	✓
UH2732SWM	32 mm	9-1/2"	2-15/64"	55/64"	1	✓
UH2736SWM	36 mm	11-21/64"	3"	63/64"	1	✓
UH2741SWM	41 mm	11-21/64"	3"	63/64"	1	✓
UH2746SWM	46 mm	11-21/64"	3"	63/64"	1	✓
UH2750SWM	50 mm	13-31/64"	3-47/64"	1-31/64"	1	✓
UH2751SWM	51 mm	13-31/64"	3-47/64"	1-31/64"	1	✓
UH2755SWM	55 mm	13-31/64"	3-47/64"	1-31/64"	1	✓
UH2760SWM	60 mm	14-13/16"	4-7/64"	1-31/64"	1	✓
UH2765SWM	65 mm	14-13/16"	4-7/64"	1-31/64"	1	✓
UH2770SWM	70 mm	12-7/8"	4-5/16"	1-3/8"	1	✓
UH2775SWM	75 mm	13"	4-21/64"	1-19/64"	1	✓
UH2780SWM	80 mm	14-3/16"	4-31/32"	1-1/2"	1	✓
UH2785SWM	85 mm	14-1/8"	4-15/16"	1-9/16"	1	✓

**NON-SPARKING STRUCTURAL BOX-END WRENCHES**

**NON-SPARKING STRUCTURAL BOX-END WRENCHES**

URREA



INCHES

12

BRONZE - ALUMINUM

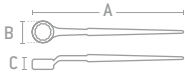

- Tools recommended for 1, 2, 21 or 22 Ex zones.
- The handle's butt end is tapered and can be used as an alignment bar to center holes in assembly operations.



ITEM	OPENING SIZE	LENGTH (A)	OUTSIDE DIAMETER (B)	HEAD THICKNESS (C)	☐	AVAILABLE
UH2615	15/16"	12"	1-9/16"	11/16"	1	✓
UH2623	1-7/16"	21"	2-3/16"	1"	1	✓
UH2630	1-7/8"	24"	2-13/16"	1-1/4"	1	✓

**NON-SPARKING STRUCTURAL OPEN-END WRENCHES**

URREA



INCHES



BRONZE - ALUMINUM



- Tools recommended for 1, 2, 21 or 22 Ex zones.
- These wrenches have an open-end. The handle's butt end is tapered and can be used as an alignment bar to center holes in assembly operations.



ITEM	OPENING SIZE	LENGTH (A)	OUTSIDE DIAMETER (B)	HEAD THICKNESS (C)	☐	AVAILABLE
UHC910	1-5/8"	23"	3-1/8"	3-5/8"	1	✓

**NON-SPARKING PIPE WRENCHES**

**NON-SPARKING PIPE WRENCHES**

URREA



INCHES

BRONZE - ALUMINUM



UH810

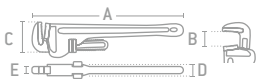

- Tools recommended for 1, 2, 21 or 22 Ex zones.
- Knurled washer that allows a quick and safe adjustment of the jaw.
- "I" beam handle design for more torque resistance.



ITEM	TOTAL LENGTH (A)	MAX. OPENING (B)	HEAD HEIGHT (C)	HANDLE DEPTH (D)	HEAD DEPTH (E)	☐	AVAILABLE
UH810	10"	1-1/4"	1-49/64"	25/32"	43/64"	1	On Request
UH812	12"	1-1/2"	2-1/4"	25/32"	53/64"	1	On Request
UH814	14"	1-15/16"	2-19/32"	15/16"	53/64"	1	On Request
UH818	18"	2-3/8"	3-11/32"	1-3/16"	1-1/32"	1	On Request
UH824	24"	2-15/16"	4-29/64"	1-37/64"	1-1/8"	1	On Request

## NON-SPARKING SCREWDRIVERS

### AMBER HANDLE NON-SPARKING SCREWDRIVERS

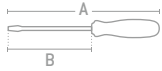

- Tools recommended for 1, 2, 21 or 22 Ex zones.
- High-resistance amber PVC handle.

ITEM	SHANK TYPE	TIP TYPE	BIT SIZE	TOTAL LENGTH (A)	EXPOSED LENGTH (B)	☞	AVAILABLE
UH9616	Round shank	⊖	1/4"	14-3/8"	10"	1	✓
UH9687	Round shank	⊕	No. 2	14-3/8"	10"	1	✓
UH9686	Round shank	⊕	No. 3	17"	12"	1	✓

## NON-SPARKING PLIERS

### BIMATERIAL HANDLE NON-SPARKING PLIERS

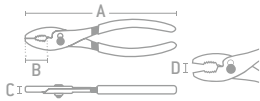

- Tools recommended for 1, 2, 21 or 22 Ex zones.
- High mechanical quality and corrosion free bronze-aluminum.

ITEM	TOTAL LENGTH (A)	JAW LENGTH (B)	JAW THICKNESS (C)	MAX OPENING (D)	CUTS WIRE	CUTTING TYPE	CUTTING EDGE	☞	AVAILABLE
UH268	8"	2"	31/64"	1-7/64"	✓	Side cutting	5/8"	1	On Request
UH206	6"	1-5/16"	25/64"	25/32"	✓	Diagonal cutting	25/32"	1	On Request
UH2292	8"	4"	7/16"	1-15/16"	✓	Side cutting	25/64"	1	On Request
UH278	8"	1-7/8"	1-19/64"	2-1/8"	-	-	-	1	On Request

## NON-SPARKING CHISELS

### NON-SPARKING CHISELS



UH86A-1X12

- Made of a bronze-aluminum alloy.
- For cutting and grooving metal.
- Tools recommended for 1, 2, 21 or 22 Ex

**BULK**

ITEM	WIDTH	TIP SIZE	LENGTH	☞	AVAILABLE
UH86A-1/4	5/16"	1/4"	5-1/8"	1	✓
UH86A-3/8	7/16"	3/8"	5-1/2"	1	On Request
UH86A-3/4X8	7/8"	3/4"	8"	1	✓
UH86A-3/4X12	7/8"	3/4"	12"	1	✓
UH86A-7/8X8	1"	13/16"	8"	1	✓
UH86A-7/8X12	1"	13/16"	12"	1	On Request
UH86A-1X8	1-3/16"	5/16"	8"	1	✓
UH86A-1X12	1-3/16"	5/16"	12"	1	✓

## NON-SPARKING WEDGES

### NON-SPARKING WEDGES



UHW1

- Ideal to separate parts as flanges.
- Tools recommended for 1, 2, 21 or 22 Ex zones.

ITEM	DIMENSIONS	☞	AVAILABLE
UHW1	150 x 25 x 13 mm	1	On Request
UHW2	180 x 50 x 19 mm	1	On Request
UHW3	200 x 20 x 30 mm	1	On Request
UHW4	230 x 40 x 20 mm	1	On Request

**NON-SPARKING SLEDGE HAMMERS**

**NON-SPARKING SLEDGE HAMMERS**

**URREA**  
STRONGEST INSULATED TOOL

**IMPROVED PRODUCT**



**UH71FG**  
34" handle

**UH72FGS**  
20" handle

**UH67FG**  
12" handle

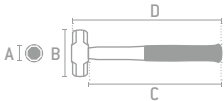

- Tools recommended for 1, 2, 21 or 22 Ex zones
- Epoxy resin connection guarantees secure shafting
- Bronze-aluminium head prevents material deformations and does not spark on impact
- New handle design, with shock absorbent guard included

**BULK**

ITEM	HEAD WEIGHT		HEAD DIAMETER (A)	HEAD LENGTH (B)	HANDLE LENGTH (C)	TOTAL LENGTH (D)	TOTAL WEIGHT		☐	AVAILABLE
	KG	LB					KG	LB		
<b>EXTRA LONG HANDLE</b>										
<b>UH71FG</b>	3.4 kg	7.5 lb	2-1/8"	6-1/8"	32-1/8"	34"	4.4 kg	9.7 lb	1	✓
<b>UH72FG</b>	4.53 kg	10 lb	2-7/32"	7-3/16"	32-1/32"	34"	5.5 kg	12.2 lb	1	✓
<b>UH73FG</b>	6.8 kg	15 lb	2-7/16"	8-1/8"	31-13/16"	34"	7.8 kg	17.2 lb	1	✓
<b>UH74FG</b>	8.16 kg	18 lb	3-3/25"	8-3/4"	31-9/64"	34"	9.15 kg	20.2 lb	1	✓
<b>LONG HANDLE</b>										
<b>UH71FGS</b>	3.4 kg	7.5 lb	2-1/8"	6-1/8"	17-7/8"	20"	3.97 kg	8.8 lb	1	✓
<b>UH72FGS</b>	4.53 kg	10 lb	2-7/32"	7-3/16"	17-51/64"	20"	5.07 kg	11.2 lb	1	✓
<b>UH73FGS</b>	6.8 kg	15 lb	2-7/16"	8-1/8"	17-9/16"	20"	7.37 kg	16.2 lb	1	✓
<b>UH74FGS</b>	8.16 kg	18 lb	3-3/25"	8-3/4"	16-7/8"	20"	8.72 kg	19.2 lb	1	On Request
<b>SHORT HANDLE</b>										
<b>UH66FG</b>	0.907 kg	2 lb	1-11/16"	4-3/4"	11-9/16"	13-1/4"	1.2 kg	2.6 lb	1	✓
<b>UH67FG</b>	1.24 kg	2.75 lb	1-3/4"	5-1/4"	12-5/8"	14-3/8"	1.5 kg	3.3 lb	1	✓
<b>UH68FG</b>	1.81 kg	4 lb	2"	5-15/16"	12-5/8"	14-3/8"	1.5 kg	3.3 lb	1	✓

NON-SPARKING AND INSULATED TOOLS

**NON-SPARKING BALL PEIN HAMMERS**

**NON-SPARKING BALL PEIN HAMMERS**

**URREA**  
STRONGEST INSULATED TOOL

**IMPROVED PRODUCT**



**UH01FG**

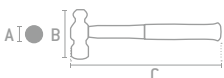

- Tools recommended for 1, 2, 21 or 22 Ex zones
- Epoxy resin connection guarantees secure shafting
- Bronze-aluminium head prevents material deformations and does not spark on impact
- New handle design, with shock absorbent guard included



ITEM	HEAD WEIGHT		HEAD DIAMETER (A)	HEAD LENGTH (B)	TOTAL LENGTH (C)	TOTAL WEIGHT		☐	AVAILABLE
	KG	OZ				KG	LB		
<b>UH00FG</b>	0.198 kg	7 oz	1-1/2"	2-3/4"	11-1/4"	0.354 kg	0.78 lb	1	✓
<b>UH01FG</b>	0.51 kg	18 oz	1-25/32"	3-1/16"	12-1/2"	0.708 kg	1.56 lb	1	✓
<b>UH02FG</b>	0.709 kg	25 oz	1-25/32"	3-1/16"	12-1/2"	0.99 kg	2.18 lb	1	✓
<b>UH03FG</b>	0.907 kg	32 oz	2-3/16"	3-3/4"	14-1/4"	1.19 kg	2.81 lb	1	✓

## NON-SPARKING BRUSHES

### NON-SPARKING BRUSH



URREA  
SUPERIOR QUALITY AFFORDABLE TOOLS



UH1885

- Ideal to eliminate corrosion and burrs.
- Tools recommended for 1, 2, 21 or 22 Ex zones.



ITEM	CONFIGURATION	DIMENSIONS	WIRE LENGTH	⊞	AVAILABLE
UH1885	6 x 16	205 mm x 48 mm	41 mm	1	On Request

### NON-SPARKING BRUSH WITH HANDLE



URREA  
SUPERIOR QUALITY AFFORDABLE TOOLS



UH1886

- Tools recommended for 1, 2, 21 or 22 Ex zones.
- Ideal to eliminate corrosion and burrs.



ITEM	CONFIGURATION	DIMENSIONS	WIRE LENGTH	⊞	AVAILABLE
UH1886	4 x 16	255 mm x 29 mm	30 mm	1	✓

## NON-SPARKING PUTTY KNIVES

### NON-SPARKING PUTTY KNIVES



URREA  
SUPERIOR QUALITY AFFORDABLE TOOLS



UH651

- Tools recommended for 1, 2, 21 or 22 Ex zones.
- Rigid blade.



ITEM	BLADE WIDTH	BLADE LENGTH	BLADE THICKNESS	⊞	AVAILABLE
UH651	1"	4"	1.5 mm	1	On Request
UH652	2"	4"	1.5 mm	1	On Request
UH653	3"	3-1/2"	1.5 mm	1	On Request
UH654	4"	3-1/2"	1.5 mm	1	On Request



CLASS	TYPE	PAGE	BRAND	
			URRER	SURTEK
Plumbing tools	Manual leak test pumps	342	•	
	Drain cleaners	342		•
Pipe tools	Flaring tools	343	•	•
	Vise stands	343	•	•
	Pipe cutters	344	•	•
	Pipe benders	347		•
	Reversible chain wrench	348	•	•
	Universal strap wrench	349	•	
	Wash basin wrench	349		•
	Pipe wrenches	349	•	•
	Pipe yoke vise	352	•	•
	Pipe threaders	353	•	•

[usa.urrea.com](http://usa.urrea.com)

We are constantly improving our products, that is why the information, characteristics and availability of them can change without prior notice.

## PRESURE TEST PUMPS

### PRESSURE TEST PUMP

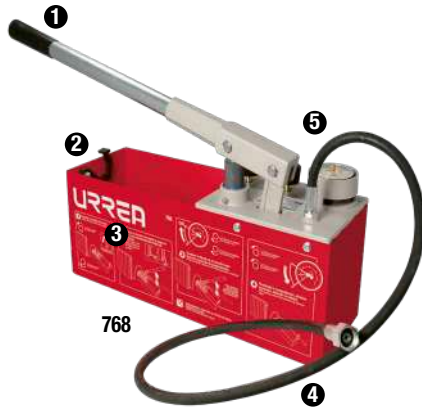

**Content:**  
 1. Handle  
 2. Blocking hook  
 3. Tank  
 4. Pressure hose  
 5. V1: closing valve,  
 V2: purge valve



**Content:**  
 1. Handle  
 2. Manometer  
 3. Tank  
 4. Pressure hose  
 5. V1: closing valve,  
 V2: purge valve

- Water tank resistant to any weather condition.
- Useful for checking for leaks in plumbing, heating, cooling, oil, and other installations.

ITEM	TANK CAPACITY	SHEET THICKNESS	HOSE LENGTH	HANDLE LENGTH	MAX PRESSURE	MAX TEMPERATURE	HOSE CONNECTOR	PUMP DIMENSIONS	SCALE	TESTING FLUID	WEIGHT	⊞	AVAILABLE
768	3.17 gal	14 gauge (1/16")	47.2"	20.5"	860 psi	50 °C	1/2"	19.7" x 7.3" x 5.5"	bar/psi/MPA	Water/oil	17.6 lb	1	✓
767	1.84 gal	14 gauge (1/16")	47.2"	14.2"	362 psi	50 °C	1/2"	14.9" x 8.5" x 6.1"	bar/psi/MPA	Water/oil	10.1 lb	1	On Request

## DRAIN CLEANERS

### DRAIN CLEANER MACHINE



- Easy-to-use, instant-acting cable clutch maximizes operator control.
- 8 different cutting heads included
- For 3/4" to 4" pipes.

ITEM	DE640
POWER	390 W
PIPE DIAMETER CAPACITY	3/4" - 4"
CABLE LENGTH	62.3 ft (19m)
ROTATION SPEED	0 - 400 rpm
<b>ACCESSORIES</b>	
CABLE	62.3ft (19 m)
CUTTING HEADS	8
ACCESSORY BARREL	1
⊞	1
AVAILABLE	On Request

### PISTOL TYPE DRAIN AUGER



- Steel wire, tightly wound on the drum to prevent deformation and facilitate movement.
- Spiral tip.
- Quick-release lock.
- Manual and drill operation (1/4" shank).

ITEM	CABLE LENGTH		CABLE DIAMETER		⊞	AVAILABLE
	FT	M	IN	MM		
DMP4	15'	4.5	1/4"	6.35	1	On Request

### DRUM AUGERS



121024



121023

Ergonomic gun type handle

- Steel spring plunger.
- Ergonomic pistol-type handle.

ITEM	CABLE LENGTH	PIPE DIAMETER	⊞	AVAILABLE
121024	14,7'	1-1/4" - 2"	1	✓
121023	25'	1-1/4" - 2"	1	✓



FLARING TOOLS

FLARING TOOL, PRESS AND PIPE CUTTER SET

**URREA**  
INDUSTRIAL DUTY 45° FLARE 3/16" - 5/8" FLARING DIAMETER

**3 PIECES**

Applications: Aluminum, Copper, Brass

Content:  
Flaring tool: 3/16", 1/4", 5/16", 3/8", 1/2" & 5/8"  
Press  
Pipe cutter: from 1/8" to 1-1/8"

ITEM	PIECES	AVAILABILITY
349	3	1 AVAILABLE ✓

TUBING CUTTER AND FLARING TOOL SET

**SURTEK**  
PROFESSIONAL USE 45° FLARE 3/16" - 5/8" FLARING DIAMETER

**3 PIECES**

Applications: Aluminum, Copper, Brass

Content:  
Flaring tool: 3/16", 1/4", 5/16", 3/8", 1/2" & 5/8"  
Press  
Pipe cutter: from 1/8" to 1-1/8"

IMPROVED PRODUCT

ITEM	PIECES	AVAILABILITY
349F	3	1 AVAILABLE ✓

FLARING TOOL WITH PRESS

**URREA**  
HEAVY DUTY 45° FLARE 1/4" - 3/4" FLARING DIAMETER

**NEW**

Applications: Aluminum, Copper, Brass

• Flaring tool made of hardened steel.  
• Ergonomic handle to reduce fatigue.  
• Machined holes with anti-slip grooves.  
• Plastic case for storage and transport.

VIDEO

ITEM	FLARING DIAMETER	AVAILABILITY
AVE14	1/4", 5/16", 3/8", 1/2", 5/8" & 3/4"	1 On Request

FLARING TOOL WITH PRESS

**URREA**  
INDUSTRIAL DUTY 45° FLARE 3/16" - 5/8" FLARING DIAMETER

Applications: Aluminum, Copper, Brass

• Flaring tool made of hardened steel.  
• T-type handle for better torque transmission  
• Machined holes with anti-slip grooves.

ITEM	FLARING DIAMETER	AVAILABILITY
351	3/16", 1/4", 5/16", 3/8", 1/2" & 5/8"	1 AVAILABLE ✓

FLARING TOOL WITH PRESS

**SURTEK**  
PROFESSIONAL USE 45° FLARE 3/16" - 5/8" FLARING DIAMETER

Applications: Aluminum, Copper, Brass

• Flaring tool made of hardened steel.  
• T-type handle for better torque transmission  
• Machined holes with anti-slip grooves.

ITEM	FLARING DIAMETER	AVAILABILITY
351F	3/16", 1/4", 5/16", 3/8", 1/2" & 5/8"	3 On Request

FLARING TOOL WITH ADJUSTABLE PRESS

**SURTEK**  
PROFESSIONAL USE 45° FLARE 3/16" - 5/8" FLARING DIAMETER

**NEW**

Applications: Aluminum, Copper, Brass

• Flaring tool made of hardened steel.  
• Easy adjustment system

ITEM	FLARING DIAMETER	AVAILABILITY
121100	3/16" to 5/8"	1 On Request

VICE STANDS

VICE STAND

**URREA**  
INDUSTRIAL DUTY

• Light and foldable, made of aluminum alloy.  
• Remains perfectly solid on all three legs.  
• To facilitate work on any type of pipe, the Urrea vise stand offers the best option in size, weight and performance.

ITEM	A	B	AVAILABILITY
464	36-5/8"	53-1/2"	1 On Request

VICE STAND

**SURTEK**  
PROFESSIONAL USE

• Base perforated legs allow additional fastening to the ground.  
• Asymmetric perforations for the PTF2 and PCF35 models.  
• Base and 3 feet included.

ITEM	DESCRIPTION	AVAILABILITY
TF1	Universal	1 On Request

## FORGED STEEL PIPE CUTTERS

### FORGED STEEL PIPE CUTTERS



- Spring-loaded system with rollers for easier cuts.
- For cutting steel and cast iron pipes.
- Includes a handle for greater leverage.



- Spring-loaded system with rollers for easier cuts.
- Ideal for cutting thick-walled metal pipes



- Spring-loaded system with rollers for easier cutting.
- For cutting steel and cast iron pipes.
- Includes a handle for greater leverage.



URREA



ITEM	CUTTING CAPACITY	LENGTH	ROLLS	MINIMUM OPENING		MAXIMUM OPENING		⊞	AVAILABLE
				IN	MM	IN	MM		
359	2" to 4"	26-3/8"	2	2"	50	4"	101	1	✓
356	1/8" to 2"	18"	2	1/8"	3	2"	50	1	On Request
355	1/8" to 1-1/4"	12"	2	1/8"	3	1-1/4"	31	1	✓

### Replacement blade pipe cutters

ITEM	FOR ITEM	⊞	AVAILABLE
359D41M	For 359	1	✓
355D31M	For 356	1	On Request
355D26M	For 355	1	✓

## QUICK ADJUSTMENT PIPE CUTTERS

### QUICK ADJUSTMENT PIPE CUTTERS



- Quick-adjust mechanism
- Aluminum die-cast body.
- Quick-change blade system
- For thin-walled metal pipes.
- Useful reamer to remove the edge after cutting.



- Extra-smooth knob for quick adjustment.
- For thin-walled metal pipes.
- Useful reamer for removing sharp edges after cutting



- For thin-walled metal pipes.
- Smooth adjustment knob

ITEM	CUTTING CAPACITY	LENGTH	ROLLS	BODY MATERIAL	SPARE BLADE INCLUDED	MINIMUM OPENING		MAXIMUM OPENING		⊞	AVAILABLE
						IN	MM	IN	MM		
350QR	1/4" to 2-5/8"	12-1/2"	4	Aluminium	•	1/4"	6	2-5/8"	66	1	✓
350P	1/8" to 1-3/8"	6"	4	Zamak	•	1/8"	3	1-3/8"	35	1	On Request
350	1/8" to 1-1/8"	5"	2	Zamak	-	1/8"	3	1-1/8"	28	1	On Request

### QUICK ADJUSTMENT PIPE CUTTER



- Quick-adjust mechanism
- Aluminum die-cast body.
- For aluminium, cooper and plastic pipes
- Useful reamer to remove the edge after cutting.



121111  
2 pieces per package

ITEM	CUTTING CAPACITY	LENGTH	ROLLS	MINIMUM OPENING	MAXIMUM OPENING	⊞	AVAILABLE
121155	1/4" - 2"	9"-1/2"	2	1/4"	2"	50	1 On Request

### Replacement blade pipe cutters

ITEM	FOR ITEM	⊞	AVAILABLE
121111	For 121155	5	On Request

STEEL PIPE CUTTERS

ZAMAK PIPE CUTTERS



350F

- Easy and smooth adjustment knob
- Zamak body construction makes it light and resistant
- Cuts aluminium, copper, brass, plastic and thin-wall steel tubing
- Includes a foldable reamer



121154



121156



121166



121110  
2 pieces per package



121114  
2 pieces per package

ITEM	CUTTING CAPACITY	LENGTH	ROLLS	MINIMUM OPENING IN	MINIMUM OPENING MM	MAXIMUM OPENING IN	MAXIMUM OPENING MM	⊞	AVAILABLE
350F	1/8" - 1-1/8"	8" - 7/8"	2	1/8"	3	1-1/8"	28	1	On Request
121154	5/32" - 2"	4"	2	5/32"	4	2"	50	3	On Request
121156	1/8" - 1-1/4"	8" - 7/8"	2	1/8"	3	1-1/4"	31	1	On Request
121166	3/4" - 1-3/4"	9" - 1/2"	2	1/4"	6	1-3/4"	45	1	On Request

Replacement blade pipe cutters

ITEM	FOR ITEM	⊞	AVAILABLE
121110	For 121156 and 350F	5	✓
121114	For 121166	6	On Request

MINI PIPE CUTTERS



348



347

- Zamak construction body makes it light and resistant
- Easy-to-change blade system
- Ball-bearing rollers bring fast and precise cuts
- Compact design for reduced spaces
- Cuts aluminium, copper, brass, plastic and thin-wall steel tubing

ITEM	CUTTING CAPACITY	LENGTH	ROLLS	MINIMUM OPENING IN	MINIMUM OPENING MM	MAXIMUM OPENING IN	MAXIMUM OPENING MM	⊞	AVAILABLE
348	1/8" to 5/8"	2-1/4"	2	1/8"	3	1-1/8"	28	1	On Request
347	1/8" to 1-1/8"	3"	2	1/8"	3	5/8"	16	1	✓

REPLACEMENT BLADES FOR PIPE CUTTERS



350D19S



350D19G



350D19C

Item	Material
350D19S	For stainless steel
350D19G	General purpose
350D19C	For cooper

ITEM	DIAMETER	FOR TIEM	⊞	AVAILABLE
350D19S	3/4" (19mm)	347, 348, 350, 350P and 350QR	1	✓
350D19G	3/4" (19mm)	347, 348, 350, 350P and 350QR	1	On Request
350D19C	3/4" (19mm)	347, 348, 350, 350P and 350QR	1	On Request

MINI PIPE CUTTERS



121153



121167

- Zamak construction body makes it light and resistant
- Ball-bearing rollers bring fast and precise cuts
- Compact design for reduced spaces
- Cuts aluminium, copper, brass, plastic and thin-wall steel tubing

ITEM	CUTTING CAPACITY	LENGTH	ROLLS	MINIMUM OPENING IN	MINIMUM OPENING MM	MAXIMUM OPENING IN	MAXIMUM OPENING MM	⊞	AVAILABLE
121153	1/8" - 7/8"	4"	2	1/8"	3	7/8"	22	1	On Request
121167	1/8" - 1-1/8"	8"	2	1/8"	3	1-1/8"	28	1	On Request

CHAIN PIPE CUTTERS



- Pipe cutters eliminate hand gripping effort and ensure perfect tracing
- Flexible chain is heat treated for longer life
- Quick-release system, no pinch lever easily unlocks pliers

ITEM	CUTTING CAPACITY	LENGTH	MAXIMUM THICKNESS	⊞	AVAILABLE
4186	1/2" - 2-1/2"	10"	For item 4186 3/32"	1	✓
4182	3/4" - 4-1/2"	12"	For item 8182 1/4"	1	On Request

## PVC PIPE CUTTERS

### PVC PIPE CUTTERS

**HEAVY DUTY** **MAGNESIUM BODY** **STEEL BLADE WITH PTFE COATING**

URREA



**1" CUTTING CAPACITY** **4 ROLLERS**

**BIMATERIAL HANDLE** **IMPACT RESISTANT**

**1-5/8" CUTTING CAPACITY**

**1-3/8" CUTTING CAPACITY**

**7/8" CUTTING CAPACITY**



332

- Scissors with magnesium body, robust and very light.
- The blade has a special geometry for cutting multilayer pipes.
- The PTFE coating makes the cut much smoother.
- Automatic blade retraction and one-handed locking system.



330

- Scissors with magnesium body, robust and very light.
- With an INOX blade of special geometry.
- The PTFE coating makes cutting smoother and easier.
- The blade is protected in the body when the scissors are open.
- Quick blade change system, no additional tools required.



329

- Scissors with magnesium body, robust and very light. With stainless steel blade of special geometry.
- PTFE coating makes cutting smoother and easier.
- Quick blade change system, no additional tools required



327

- Scissors with magnesium body.
- The effort required for cutting is minimal thanks to the geometry of the blade and its PTFE coating.
- The blade recoil is automatic.
- It is very light and easy to handle.



ITEM	CUTTING CAPACITY	TOTAL LENGTH	BLADE THICKNESS	AUTO-RETRACTABLE BLADE SYSTEM	PIPE MATERIALS THAT CAN BE CUT								⊞	AVAILABLE			
					PE	PPR	PVC	PP	MLP/MSR	PVDF	PB	VPE			PEX	CPVC	
332	1" (26 mm)	7-21/64" (186 mm)	1/16" (1.8 mm)	•	•	•	•	•	•	•	•	•	•	•	•	1	✓
330	1-5/8" (41 mm)	9-7/16" (240 mm)	7/64" (2.8 mm)	•	•	•	•	•	•	•	•	•	•	•	•	1	On Request
329	1-3/8" (35 mm)	8-5/8" (203 mm)	7/64" (2.8 mm)	-	•	•	•	•	•	•	•	•	•	•	•	1	✓
327	7/8" (22 mm)	6-39/64" (168 mm)	1/32" (0.9 mm)	•												1	✓

**HEAVY DUTY**



332R



330R



329R



327R

- Easy-to-change cutters
- PTFE coating

### Replacement blade pvc pipe cutters

ITEM	FOR ITEM	⊞	AVAILABLE
332R	for model 332	1	✓
330R	for model 330	1	✓
329R	for model 329	1	✓
327R	for model 327	1	✓



### PVC PIPE CUTTER

**PROFESSIONAL USE** **1/8" - 1-5/8" CUTTING CAPACITY**

SURTEK



VIDEO



- Progressive advance of blade without return.
- Cutter with heat treatment.
- To cut PVC, hoses, etc.
- Metal body.



ITEM	CUTTING CAPACITY	LENGTH	MINIMUM OPENING		MAXIMUM OPENING		⊞	AVAILABLE
			IN	MM	IN	MM		
121120	1/8" - 1-5/8"	10-3/4"	1/8"	3	1-5/8"	42	1	On Request

**PIPE BENDERS**

**HYDRAULIC TRIPOD PIPE BENDER**



**12t**  
CAPACITY

**CAST IRON**  
BODY



- 180° maximum angle bending.
- For DIN-2440 and DIN-2441 medium and soft.
- Heavy steel pipes.
- It is also suit for bending common water pipe, carbon steel pipe and thick-wall conduit tube.
- Includes dies for 1/2", 3/4", 1", 1-1/4", 1-1/2" & 2" pipes.

ITEM	MINIMUM PIPE SIZE	MAXIMUM PIPE SIZE	MAXIMUM PRESSURE CAPACITY	☞	AVAILABLE
<b>DTH12</b>	1/2"	2"	12 t	1	On Request

**MANUAL PIPE BENDER**



**NEW**



- With interchangeable dies.
- 180° maximum angle bending.
- For flexible cooper and aluminium pipes

ITEM	PIPE DIAMETER CAPACITIES	☞	AVAILABLE
<b>121164</b>	1/2", 5/8" and 7/8"	1	On Request

**CONDUIT PIPE BENDERS**



**112605**

Bending capacity		
ITEM	Thin-Wall	Thick-Wall
<b>112605</b>	1/2"	-
<b>112606</b>	3/4"	1/2"
<b>112607</b>	1"	3/4"

- Made of cast iron steel
- Wide stable foot pedal
- Reference angle for quick, accurate bends.

ITEM	PIPE DIAMETER	☞	AVAILABLE
<b>112605</b>	1/2"	1	On Request
<b>112606</b>	3/4"	1	On Request
<b>112607</b>	1"	1	On Request



**HYDRAULIC PIPE BENDERS**



**12t**  
CAPACITY



**NEW**



**DT12**

DIES INCLUDED							
ITEM	1/2"	3/4"	1"	1-1/4"	1-1/2"	2"	2-1/2" 3"
<b>DT12</b>	•	•	•	•	•	•	• 6
<b>DT16</b>	•	•	•	•	•	•	• 8

- 90° maximum angle bending.
- For bending common water pipe, carbon steel pipe and thick-wall conduit tube (max 3/32", 2.7mm thickness)



ITEM	MINIMUM PIPE SIZE	MAXIMUM PIPE SIZE	MAXIMUM PRESSURE CAPACITY	☞	AVAILABLE
<b>DT12</b>	1/2"	2"	12 t	1	On Request
<b>DT16</b>	1/2"	3"	16 t	1	On Request

**MANUAL PIPE BENDER**



- 180° maximum angle bending.
- For flexible cooper and aluminium pipes.
- Helps prevent kinking and flattening.

ITEM	PIPE DIAMETER CAPACITIES	☞	AVAILABLE
<b>121162</b>	1/4", 5/16" and 3/8"	1	✓



**112609**  
40" Handle



- Made from high-strength steel to eliminate bend and provide excellent feel, control and leverage.

<b>Handles</b>				
ITEM	FOR ITEMS	LENGHT	☞	AVAILABLE
<b>112609</b>	112605 & 112606	40"	3	✓
<b>112610</b>	112607	60"	3	On Request

**BULK**

## REVERSIBLE CHAIN WRENCH

### REVERSIBLE CHAIN WRENCHES



794C

- Double-sided toothting: for ratchet-like working with right-left rotation.
- Strong chain made of hardened and tempered special steel.
- Adapts to all pipe shapes.
- Replaceable jaws available.



ITEM	TOTAL LENGTH	MAX. PIPE CAPACITY	CHAIN LENGTH	☞	AVAILABLE
794C	13-3/4"	1-1/2"	13"	1	✓
795C	28"	2-1/2"	17"	1	✓
796C	37-1/2"	4"	21-3/4"	1	✓
797C	47-1/4"	6"	31"	1	✓
798C	50-1/2"	8"	38"	1	✓
799C	63-3/4"	12"	54"	1	✓



R794C

URREA



### Spare chains for reversible chain wrenches

ITEM	REPLACEMENT FOR	CHAIN LENGTH	☞	AVAILABLE
R794C	794C	13"	1	On Request
R795C	795C	17"	1	✓
R796C	796C	21-3/4"	1	On Request
R797C	797C	31"	1	✓
R798C	798C	38"	1	On Request
R799C	799C	54"	1	✓

### REVERSIBLE CHAIN WRENCHES



796UR

- Double-sided toothting: for ratchet-like working with right-left rotation.
- Strong chain made of hardened and tempered special steel.
- Adapts to all pipe shapes.



ITEM	TOTAL LENGTH	MAX. PIPE CAPACITY	CHAIN LENGTH	☞	AVAILABLE
795UR	28"	2-1/2"	17"	1	On Request
796UR	37-1/2"	4"	21-3/4"	1	On Request
797UR	47-1/4"	6"	31"	1	On Request
798UR	50-1/2"	8"	38"	1	On Request
799UR	63-3/4"	12"	54"	1	On Request

### UNIVERSAL PIPE WRENCH



- Double-sided teeth surface set against the turning direction: For optimum performance in both directions without moving.
- Robust: profile handle made from drop-forged chrome vanadium steel and a strong chain made of tempered special steel provide a high durability.
- Spare chain available is R794C.

URREA



ITEM	TOTAL LENGTH	MAX. PIPE CAPACITY	CHAIN LENGTH	☞	AVAILABLE
801	12"	4"	17-9/32"	1	✓

### UNIVERSAL CHAIN PIPE WRENCH



- Double-sided teeth surface set against the turning direction: For optimum performance in both directions without moving.
- Robust: profile handle made from drop-forged chrome vanadium steel and a strong chain made of tempered special steel provide a high durability.



ITEM	TOTAL LENGTH	MAX. PIPE CAPACITY	CHAIN LENGTH	☞	AVAILABLE
801UI	12"	4"	17-9/32"	1	On Request

### UNIVERSAL PIPE WRENCH



SURTEK



ITEM	LENGTH	MAX. PIPE CAPACITY	☞	AVAILABLE
121056	12"	4-3/4"	4	On Request

**UNIVERSAL STRAP WRENCH**

**UNIVERSAL STRAP WRENCH**



- Ideal for installing and repairing pipes and fittings without marking or damaging.



ITEM	TOTAL LENGTH	MAX. PIPE CAPACITY	STRAP LENGTH	⊞	AVAILABLE
802	12"	3"	17"	1	On Request

**CHROME WASH BASIN WRENCH**

**CHROME WASH BASIN WRENCH**



- Movable jaws open up to 90°.
- With two universally adjustable, knurled jaws.



ITEM	TOTAL LENGTH	⊞	AVAILABLE
8412	12"	6	On Request

**PIPE WRENCHES**

**ALUMINUM PIPE WRENCHES**



810A

- Made of high-resistance aluminium alloy.
- 40% lighter compared with a conventional ductil-iron pipe wrench.
- Jaws made of chrome vanadium steel alloy for maximum strenght.



ITEM	TOTAL LENGTH	MAX. PIPE CAPACITY	WEIGHT	⊞	AVAILABLE
810A	10"	1-1/2"	1 lb	1	✓
814A	14"	2"	2 lbs	1	✓
818A	18"	2-1/2"	3.5 lbs	1	✓
824A	24"	3"	5.3 lbs	1	✓
836A	36"	5"	11 lbs	1	✓

**ALUMINUM PIPE WRENCHES**



810AUR

- Made of high-resistance aluminium alloy.
- 40% lighter compared with a conventional ductil-iron pipe wrench.
- Jaws made of chrome vanadium steel alloy for maximum strenght.



ITEM	TOTAL LENGTH	MAX. PIPE CAPACITY	WEIGHT	⊞	AVAILABLE
810AUR	10"	1-1/2"	1 lb	1	On Request
814AUR	14"	2"	2 lbs	1	On Request
818AUR	18"	2-1/2"	3.5 lbs	1	On Request
824AUR	24"	3"	5.3 lbs	1	On Request
836AUR	36"	5"	11 lbs	1	On Request

## PIPE WRENCHES

### ALUMINUM PIPE WRENCHES



**SURTEK**  
TOOLS FOR SPECIALISTS



**NEW**



8510A

- Made of high-resistance aluminium alloy.

ITEM	TOTAL LENGTH	MAX. PIPE CAPACITY	WEIGHT	☞	AVAILABLE
8510A	10"	1-3/4"	1.2 lb	1	On Request
8512A	12"	2-1/4"	1.7 lb	1	On Request
8514A	14"	2-1/2"	2 lb	1	On Request
8518A	18"	3"	3.2 lb	1	On Request
8524A	24"	3-1/2"	5.2 lb	1	On Request



### DUCTILE IRON PIPE WRENCHES



**URREA**  
SUPER QUALITY AFFORDABLE TOOLS



814HD

- Made of ductile-iron housing, designed to withstand heavy-duty and long-term use.
- Hook jaws gives maximum gripping power with quick ratcheting action.
- Easy to replace parts.

ITEM	TOTAL LENGTH	MAX. PIPE CAPACITY	WEIGHT	☞	AVAILABLE
808HD	8"	1"	0.7 lbs	1	✓
810HD	10"	1-1/2"	1.7 lbs	1	✓
812HD	12"	2"	2.6 lbs	1	✓
814HD	14"	2"	3.5 lbs	1	✓
818HD	18"	2-1/2"	5.7 lbs	1	✓
824HD	24"	3"	9.7 lbs	1	✓
836HD	36"	5"	19 lbs	1	✓
848HD	48"	6"	34.4 lbs	1	✓
860HD	60"	8"	43.4 lbs	1	✓



### DUCTILE IRON PIPE WRENCHES



**URREA**  
SUPER QUALITY AFFORDABLE TOOLS



824UI

- Made of ductile-iron housing.
- Hook jaws gives maximum gripping power with quick ratcheting action.

ITEM	TOTAL LENGTH	MAX. PIPE CAPACITY	WEIGHT	☞	AVAILABLE
808UI	8"	1"	1.2 lb	1	✓
810UI	10"	1-1/2"	2 lb	1	✓
812UI	12"	2"	3 lb	1	✓
814UI	14"	2"	3.8 lb	1	✓
818UI	18"	2-1/2"	6.2 lb	1	✓
824UI	24"	3"	9.7 lb	1	✓
836UI	36"	5"	17.2 lb	1	✓
848UI	48"	6"	31.7 lb	1	✓





PIPE WRENCHES

DUCTILE IRON PIPE WRENCHES



8510

- Made of ductile-iron housing.
- Graduated reference on movable jaw for better reference

ITEM	TOTAL LENGTH	MAXIMUM PIPE CAPACITY	WEIGHT	☞	AVAILABLE
8508	8"	1-1/2"	0.8 lb	1	On Request
8510	10"	1-3/4"	1.6 lb	1	On Request
8512	12"	2-1/4"	2.3 lb	1	On Request
8514	14"	2-1/2"	3.0 lb	1	On Request
8518	18"	3"	4.5 lb	1	On Request
8524	24"	3-15/32"	7.2 lb	1	On Request
8536	36"	5"	14.0 lb	1	On Request
8548	48"	6"	20.8 lb	1	On Request

OFFSET PIPE WRENCHES



- Offset pliers head: Suitable for work in awkward positions.
- Made of high-resistance aluminium alloy.

ITEM	TOTAL LENGTH	MAX. PIPE CAPACITY	☞	AVAILABLE
818AO	18"	2-1/2"	1	✓

MOVABLE JAWS



FIXED HEEL JAW AND PINS



KNURLED ROLLER NUTS



818B



808C



808D

ITEM	FOR MODELS	☞	AVAILABLE
808B	808HD	1	✓
810B	810HD, 810A	1	✓
812B	812HD	1	✓
814B	814HD, 814A	1	✓
818B	818HD, 818A	1	✓
824B	824HD, 824A	1	✓
836B	836HD, 836A	1	✓
848B	848HD	1	✓

ITEM	FOR MODELS	☞	AVAILABLE
808C	808HD	1	✓
810C	810HD, 810A	1	✓
812C	812HD	1	On Request
814C	814HD, 814A	1	✓
818C	818HD, 818A	1	✓
824C	824HD, 824A	1	✓
836C	836HD, 836A	1	✓
848C	848HD	1	✓

ITEM	FOR MODELS	☞	AVAILABLE
808D	808HD	1	✓
810D	810HD, 810A	1	✓
812D	812HD	1	✓
814D	814HD, 814A	1	✓
818D	818HD, 818A	1	On Request
824D	824HD, 824A	1	✓
836D	836HD, 836A	1	On Request
848D	848HD	1	✓

## PIPE WRENCHES

### MOVABLE JAWS



818B



### FIXED HEEL JAW AND PINS



808C



### KNURLED ROLLER NUTS



808D



ITEM	FOR MODELS	🔗	AVAILABLE
808BI	808UI, 808UR	1	On Request
810BI	810UI, 810UR, 810AUR	1	On Request
812BI	812UI, 812UR	1	On Request
814BI	814UI, 814UR, 814AUR	1	On Request
818BI	818UI, 818UR, 818AUR	1	On Request
824BI	824UI, 824UR, 824AUR	1	On Request
836BI	836UI, 836UR, 836AUR	1	On Request
848BI	848UI, 848UR	1	On Request

ITEM	FOR MODELS	🔗	AVAILABLE
808CI	808UI, 808UR	1	On Request
810CI	810UI, 810UR, 810AUR	1	On Request
812CI	812UI, 812UR	1	On Request
814CI	814UI, 814UR, 814AUR	1	On Request
818CI	818UI, 818UR, 818AUR	1	On Request
824CI	824UI, 824UR, 824AUR	1	On Request
836CI	836UI, 836UR, 836AUR	1	✓
848CI	848UI, 848UR	1	On Request

ITEM	FOR MODELS	🔗	AVAILABLE
808DI	808UI, 808UR	1	On Request
810DI	810UI, 810UR, 810AUR	1	On Request
812DI	812UI, 812UR	1	On Request
814DI	814UI, 814UR, 814AUR	1	On Request
818DI	818UI, 818UR, 818AUR	1	On Request
824DI	824UI, 824UR, 824AUR	1	On Request
836DI	836UI, 836UR, 836AUR	1	On Request
848DI	848UI, 848UR	1	On Request

## PIPE YOKE VISE

### PIPE YOKE VISES



452



- Made of cast iron steel.
- Movable upper clamping jaw for a secure hold.
- Resistant epoxy powder coating, for any weather condition.
- 4-point support of the pipe to hold pipes firmly and to avoid deformations.



ITEM	MINIMUM PIPE CAPACITY	MAXIMUM PIPE CAPACITY	LOAD CAPACITY	🔗	AVAILABLE
450	1/8"	2"	120 Nm	1	On Request
451	1/8"	3"	190 Nm	1	On Request
452	1/8"	4"	300 Nm	1	On Request

### PIPE CHAIN VISES



210



- V-shaped tube support with teeth and intermediate web, prevents bending during clamping.
- Quick release with eccentric lever and pretensioning screw, for rapid work preparation.



ITEM	MINIMUM PIPE CAPACITY	MAXIMUM PIPE CAPACITY	CHAIN LOAD CAPACITY	🔗	AVAILABLE
210	1/8"	2-1/2"	8,600 lb	1	✓
211	1/8"	4"	8,818 lb	1	✓
212	1/8"	6"	15,432 lb	1	On Request

### PIPE YOKE VISE



- Made of cast iron steel.
- Fits on universal workbenches.



ITEM	MINIMUM PIPE CAPACITY	MAXIMUM PIPE CAPACITY	LOAD CAPACITY	🔗	AVAILABLE
PTF2	1/8"	2"	100 Nm	1	✓

### PIPE CHAIN VISE



- Cast iron body.
- Includes posts to manually bend tubes.



ITEM	MINIMUM PIPE CAPACITY	MAXIMUM PIPE CAPACITY	CHAIN LOAD CAPACITY	🔗	AVAILABLE
PCF35	1/8"	3-1/2"	5510 lb	1	✓

PIPE THREADERS

PLUMBING SET



8  
PIECES



ITEM	PIECES	AVAILABLE
852	8	1 ✓

PIPE THREADERS SETS



9  
PIECES



5  
PIECES

RATCHETING PIPE THREADER



5  
PIECES

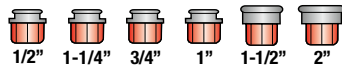
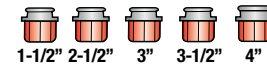

- Quick-change holder for tapping heads for effortless replacement.
- Optimized cutting geometry enables easy cutting and excellent chip flow.



ITEM	THREAD CAPACITY	AVAILABLE
851	1/2" to 2" NPT pipe	1 ✓

ITEM	THREAD CAPACITY	AVAILABLE
850	1/2" to 1" NPT pipe	1 ✓

- Double ratchet system (left and right) with easy pipe centering to ensure perfect threads.
- Open body which facilitates chip disposal
- Heavy, strong body, handles make work easier.



ITEM	THREAD CAPACITY	AVAILABLE
853	2-1/2" to 4" NPT pipe	1 ✓

PIPE THREADER SETS



9  
PIECES

Important to lubricate before and after its use.

4  
PIECES

Important to lubricate before and after its use.

ROUND DIE HANDLE



TMP10



TMP5



- Dies made of hardened steel alloy.
- Body made of cast iron steel.
- Cuts standard NPT thread on external pipe threads.



123910

- For round dies
- Features a knurled grip for a secure and comfortable hold, allowing for precise control and reducing risk of slipping during use.



ITEM	THREAD CAPACITY	AVAILABLE
TMP10	1/2" to 2" NPT pipe	1 On Request

ITEM	THREAD CAPACITY	AVAILABLE
TMP5	1/2" to 1" NPT pipe	1 On Request

ITEM	SIZE	AVAILABLE
123910	1"	1 On Request
123911	1-1/2"	1 On Request

## REPLACEMENTS FOR THREADER

### DIE HEAD RATCHET HANDLE 1-1/2" AND 2"



ITEM	DIE CAPACITY	⊞	AVAILABLE
850RH	1-1/2", 2"	1	✓

### DIE HEADS



850-3/4



ITEM	DESCRIPTION	⊞	AVAILABLE
850-1/4	1/4" NPT	1	✓
850-3/8	3/8" NPT	1	✓
850-1/2	1/2" NPT	1	✓
850-3/4	3/4" NPT	1	✓
850-1	1" NPT	1	✓
850-1 1/4	1-1/4" NPT	1	✓
850-1 1/2	1-1/2" NPT	1	✓
850-2	2" NPT	1	On Request

### PIPE THREADING ADAPTER



ITEM	DIE CAPACITY	⊞	AVAILABLE
850HA	1/4" to 1-1/4"	1	✓

### THREADING DIE SETS



850-1/4P



• Made of hardened steel alloy

ITEM	DESCRIPTION	⊞	AVAILABLE
850-1/4P	1/4" NPT	1	✓
850-3/8P	3/8" NPT	1	✓
850-1/2P	1/2" NPT	1	✓
850-3/4P	3/4" NPT	1	✓
850-1P	1" NPT	1	✓
850-1 1/4P	1-1/4" NPT	1	✓
850-1 1/2P	1-1/2" NPT	1	✓
850-2P	2" NPT	1	✓

## REPLACEMENTS FOR THREADER



MAT01



MAT02



ADT01



TMP-1/2



TMP-3/4



TMP-1



TMP-2



JPT-1/2



JPT-3/4



JPT-1



JPT-2

ITEM	PIPE DIAMETER	MATERIAL	FOR ITEM	⊞	AVAILABLE
<b>Die head ratchet handle</b>					
MAT01	N/A	Cast iron steel	TMP10	1	On Request
MAT02	N/A	Cast iron steel	TMP5	1	On Request
<b>Pipe threading adapter</b>					
ADT01	N/A	Cast iron steel	TMP5 and TMP10	1	On Request
<b>Die heads</b>					
TMP-1/2	1/2"	9CR2	TMP5 and TMP10	1	On Request
TMP-3/4	3/4"	9CR2	TMP5 and TMP10	1	On Request
TMP-1	1"	9CR2	TMP5 and TMP10	1	On Request
TMP-2	2"	9CR2	TMP5 and TMP10	1	On Request
<b>Threading die sets</b>					
JPT-1/2	1/2"	9CR2	TMP-1/2	1	On Request
JPT-3/4	3/4"	9CR2	TMP-3/4	1	On Request
JPT-1	1"	9CR2	TMP-1	1	On Request
JPT-2	2"	9CR2	TMP-2	1	On Request

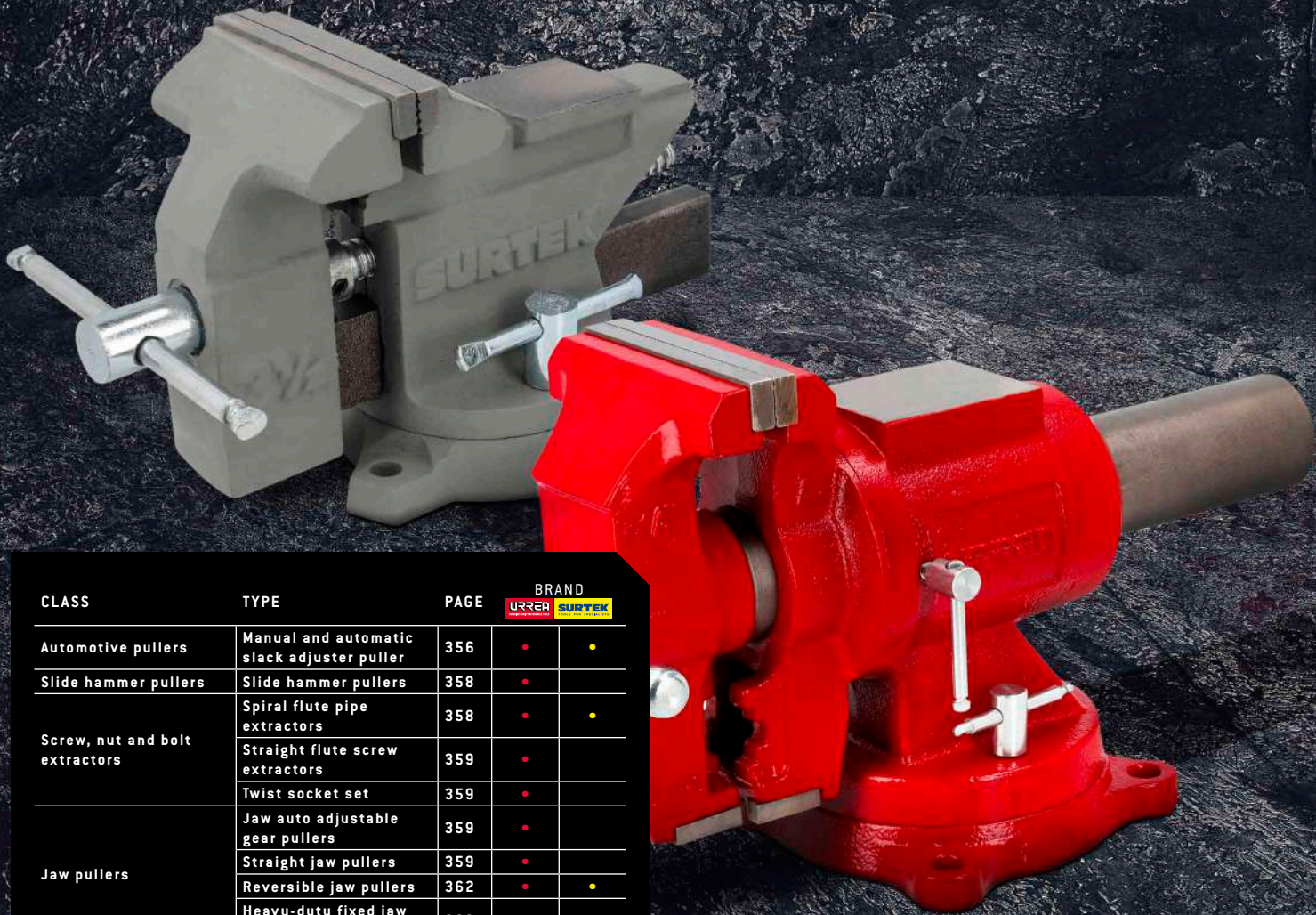

CLASS	TYPE	PAGE	BRAND	
			URREA	SURTEK
Automotive pullers	Manual and automatic slack adjuster puller	356	•	•
Slide hammer pullers	Slide hammer pullers	358	•	
Screw, nut and bolt extractors	Spiral flute pipe extractors	358	•	•
	Straight flute screw extractors	359	•	
	Twist socket set	359	•	
Jaw pullers	Jaw auto adjustable gear pullers	359	•	
	Straight jaw pullers	359	•	
	Reversible jaw pullers	362	•	•
Vises	Heavy-duty fixed jaw pullers	363	•	
	Workbenches	363	•	•
	Precision milling vises	363	•	
	Drill press vises	364	•	
	C-clamps	364	•	•
	F-clamps	365	•	•
	Quick release bar clamp	365	•	•
	Pipe clamp	366	•	•
Workbench vises	367	•	•	

[usa.urrea.com](http://usa.urrea.com)

We are constantly improving our products, that is why the information, characteristics and availability of them can change without prior notice.

# 12 PULLERS AND CLAMPS

## MANUAL AND AUTOMATIC SLACK ADJUSTER PULLER

### MANUAL & AUTOMATIC SLACK ADJUSTER PULLER

INDUSTRIAL DUTY

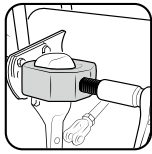

URREA



- Manual Slack Adjuster Puller found on class 7 and 8 truck and trailer brake systems

ITEM	DESCRIPTION	AVAILABILITY	AVAILABLE
2372	For slack adjustments	1	✓

## BROKEN PLUG REMOVER

### BROKEN PLUG REMOVER

INDUSTRIAL DUTY

6 PIECES

Content	Quantity
Pusher body.	1
Pusher screw.	1
Tip.	1
Puller housing.	1
Puller screw.	1
Left hand hex nut.	1



URREA



- Removes broken spark plugs from Triton® and Ford® engines, models 2004 and older.

ITEM	PIECES	AVAILABILITY	AVAILABLE
UExBT	6	1	On Request

## WHEEL DRIVE HUB PULLER

### FRONT WHEEL DRIVE HUB PULLER

INDUSTRIAL DUTY



URREA



- Use on any vehicle with studs that are inside the drum and has a tapered axle and 4-6 lugs.

ITEM	MINIMUM OPENING	MAXIMUM OPENING	SCREW SIZE	AVAILABILITY	AVAILABLE
4276	4"	4-1/2"	5/8" - 18 UNF	1	✓

## GOATLEG PULLEY PULLER

### GOATLEG PULLEY PULLER

INDUSTRIAL DUTY



URREA



- Designed to remove pressed-on 1 or 2 groove pulleys from alternators and power steering pumps without damage.
- It fits both large and small pulleys found on older domestic and import passenger cars.

ITEM	MINIMUM OPENING	MAXIMUM OPENING	AVAILABILITY	AVAILABLE
4053	1-3/8"	1-3/4"	1	✓

### GOATLEG PULLEY PULLER

PROFESSIONAL USE



SURTEK



- To remove power Steering Pump / Alternator Pulley.

ITEM	MINIMUM OPENING	MAXIMUM OPENING	AVAILABILITY	AVAILABLE
107290	1-1/4"	1-3/4"	1	On Request

## HARMONIC BALANCER PULLERS

### HARMONIC BALANCER PULLER SETS

INDUSTRIAL DUTY

TYPE C

25 PIECES



4205A

17 PIECES



4205

URREA



- Designed for use on harmonic balancers crankshaft pulleys steering wheels and gear pulleys.
- Hardened forcing screws.

ITEM	PIECES	AVAILABILITY	ITEM	PIECES	AVAILABILITY
4205A	25	1 ✓	4205	17	1 ✓

### HARMONIC BALANCER PULLER SETS

PROFESSIONAL USE

TYPE C

15 PIECES



107234

13 PIECES



107236

SURTEK



- Designed for use on harmonic balancers crankshaft pulleys steering wheels and gear pulleys.
- Hardened forcing screws.

ITEM	PIECES	AVAILABILITY	ITEM	PIECES	AVAILABILITY
107234	15	1 On Request	107236	13	1 On Request

## STEERING WHEEL LOCK PLATE REMOVER

PROFESSIONAL USE



SURTEK



- Designed to use on almost any GM or Chrysler steering column containing a snap ring retained style lock plate.
- Made from high quality carbon steel for long lasting tool life and maximum durability.

ITEM	DEPTH	OPENING	SCREW LENGTH	AVAILABILITY	AVAILABLE
	in mm	in mm	in mm		
107297	4-3/4" 120	2-3/8" 60	5-3/4" 146	1	On Request

**URREA**  
SUPERIOR QUALITY AFFORDABLE TOOLS

SUPERIOR Accuracy

usa.urrea.com      GEAR AND BEARING SEPARATORS

**GEAR AND BEARING SEPARATOR**

**BAR-TYPE PULLER/BEARING SEPARATOR SET**



**12**  
PIECES



Contents	
Bearing separator from 1-1/4" to 2-1/4"	1
Bearing separator from 2-1/4" to 3-1/2"	1
Forcing screw 7"	1
Cross bar	1
2-9/16" hex bar legs	1
2-9/16" hex bar extension legs	1
2-21/32" hex bar legs	1
2-21/32" hex bar extension legs	1

- Enables to complete a wide range of pulling jobs, ideal for removing large or small bearings on front and rear wheel hub axle shafts, as well as gears, pulleys, and steering wheels.

ITEM	DESCRIPTION	☐	AVAILABLE
J4330	Bar-type puller/bearing separator set	1	✓

**GEAR AND BEARING SEPARATORS**



4331

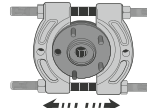

- Removes bearings, pinions, gears, pulleys, steering wheels, and fittings from shafts; Fit for automobiles, ATVs, and power sport vehicles.
- Constructed from heat treated and chrome-plated steel with a black oxide finish for rust resistance and strength.

ITEM	FORCING SCREWS	MINIMUM OPENING	MAXIMUM OPENING	☐	AVAILABLE
4331	M10X2.4	1-1/4"	2-1/4"	1	✓
4332	12MX20	3"	4-1/2"	1	✓
4333	3/4-16NF	3-7/8"	5-7/8"	1	✓
4334	1-12NF	5-7/8"	7-7/8"	1	✓

**GEAR AND BEARING SEPARATOR**



107289

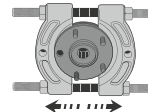

- Removes bearings, pinions, gears, pulleys, steering wheels, and fittings from shafts.
- Sharp angled edges on tapered bevel which are easily placed behind the part to secure a gripping surface

ITEM	FORCING SCREWS	MINIMUM OPENING	MAXIMUM OPENING	☐	AVAILABLE
107288	3/8"- 24NF x 5"	1-1/4"	2-1/4"	1	On Request
107289	M16-2 x 174 mm	3"	4-1/8"	1	On Request

**TIMING GEAR PULLER**

**TIMING GEAR PULLER**



- For removing timing gears, fan pulleys, harmonic balancers, and many other parts having tapped holes

ITEM	MAXIMUM OPENING	☐	AVAILABLE
107292	1-1/2" to 4-1/2"	1	On Request

**HARMONIC DAMPER PULLEY PULLER**



**6**  
PIECES



- Designed to remove damping pulleys in tight engine compartments without need to remove radiator.
- Compatible with a wide range of vehicles, mainly Chrysler, Hyundai and Mazda.

ITEM	PRESENTATION	☐	AVAILABLE
4050	Plastic box	1	✓

**PITMAN PULLERS**

**HEAVY DUTY PITMAN PULLER FOR LARGE VEHICLES AND TRUCKS**



- A heavy-duty puller for the large Pitman arms on trucks.
- Jaws are forged and heat-treated for strength.

ITEM	MAXIMUM OPENING	☐	AVAILABLE
4052	2-1/2"	1	✓

**COMPACT CARS PITMAN ARM PULLER FOR SMALL VEHICLE**



- To separate pitman arm from steering gear in almost all small cars.
- Jaws are forged and heat-treated for strength.

ITEM	MAXIMUM OPENING	☐	AVAILABLE
4051	1-3/4"	1	✓

**PITMAN PULLER FOR LARGE VEHICLES AND TRUCKS**



- For the large Pitman arms on trucks.
- Jaws are forged and heat-treated for strength.

ITEM	MAXIMUM OPENING	☐	AVAILABLE
107249	2-1/2"	1	On Request

# 12 PULLERS AND CLAMPS

## HAMMER PULLERS

### INTERNAL AND EXTERNAL SLIDE HAMMER PULLER SET



**8  
PIECES**



Contents	
Collets	3
Slide hammer	1
Puller (internal/external)	1
Puller (internal)	1

- Extremely versatile puller designed to accomplish many pulling jobs involving gears, bearings, outer races, grease retainers, oil seals, and more.
- Configurable as a two or three jaw puller using included components.
- Includes 3 blind hole bearing pullers.



ITEM	EXTERNAL CAPACITY	INTERNAL CAPACITY	⊞	AVAILABLE
4702	Ø 0-75 mm	Ø 25-100 mm	1	✓

### 2 OR 3 JAW SLIDE HAMMER PULLER SET



- Extremely versatile puller designed to accomplish many pulling jobs involving gears, bearings, outer races, grease retainers, oil seals, and more.
- Configurable as a two or three jaw puller using included components; handles 'inside' pulling jobs such as bearing cups and outer races as well as regular 'outside' pulling jobs.



ITEM	JAWS	JAWS TO REACH DISTANCE	INTERNAL CAPACITY		EXTERNAL CAPACITY		⊞	AVAILABLE
			MIN	MAX	MIN	MAX		
4285	2	2-15/16"	1-3/8"	4-5/16"	1-31/32"	5-1/2"	1	✓
	3	2-15/16"	1-31/32"	5-5/16"	25/32"	5-5/16"		

### 3-JAW SLIDE HAMMER PULLER



- Puller designed to accomplish many pulling jobs involving gears, bearings, outer races, grease retainers, oil seals, and more.



ITEM	JAWS	JAWS TO REACH DISTANCE	MIN	MAX	⊞	AVAILABLE
4270A	3	1-7/8"	1-1/2"	4-1/4"	1	✓



PULLERS AND CLAMPS

## SPIRAL FLUTE PIPE EXTRACTORS

### SPIRAL FLUTE PIPE EXTRACTORS



- Designed to remove broken studs, bolts, socket screws, and fittings.
- Left handed spiral design for extra gripping power.



SCREW EXTRACTOR SET	
ITEM	9500B
PIECES	5
PACKING	
BOX	E306
⊞	1
AVAILABLE	✓

ITEM	CAPACITY	HOLE SIZE	⊞	AVAILABLE
95001	1/8" to 1/4"	5/64"	•	On Request
95002	1/4" to 5/16"	7/64"	•	On Request
95003	5/16" to 7/16"	5/32"	•	On Request
95004	7/16" to 9/16"	7/32"	•	On Request
95005	9/16" to 3/4"	17/64"	•	On Request

### DRILL BIT SCREW EXTRACTOR SET



**10  
PIECES**

Content	
Extractors 3/32" to 5/8" (3 mm to 15 mm)	5
Drill bits 5/64" to 19/64"	5



- Set includes spiral flute pipe extractor and its respective drill bit.

ITEM	PIECES	⊞	AVAILABLE
107044	10	1	On Request

### SPIRAL FLUTE SCREW EXTRACTOR SET



**5  
PIECES**

Content	
Extractors 1/8" to 3/4" (3 mm to 19 mm)	5



- Designed to remove broken studs, bolts, socket screws, and fittings.
- Left handed spiral design for extra gripping power.

ITEM	PIECES	⊞	AVAILABLE
107040	5	1	On Request



**STRAIGHT FLUTE SCREW EXTRACTORS**

**STRAIGHT FLUTE SCREW EXTRACTORS**



• Designed to remove broken studs, set screws, pipes and alermit fittings.

ITEM	SQUARE	DRILL SIZE	BOLT SIZE	PIPE SIZE	Ø	EXTRACTOR SETS	
						9500A	9501A
9521	3/16"	1/8"	5/16"	-	6	On Request	•
9522	3/16"	3/16"	3/8"	-	6	On Request	•
9523	1/4"	15/64"	7/16"	1/8"	6	On Request	•
9524	5/16"	5/16"	1/2 y 9/16"	1/4"	6	On Request	•
9525	3/8"	3/8"	5/8"	3/8"	6	On Request	•
9526	7/16"	15/32"	3/4"	3/8"	1	✓	•
9527	1/2"	9/16"	7/8"	1/2"	1	✓	•
9528	5/8"	21/32"	1-1/8"	1/2"	1	✓	•
9529	3/4"	13/16"	1-3/8"	3/4"	1	✓	•



**TWIST SOCKET SET WITH PUNCH**

**TWIST SOCKET SET WITH PUNCH**



**13**  
PIECES



• End with hex opening. • End with twist opening.

• Designed to easily remove damaged, rounded or corroded nuts, wheel lugs, bolts, pipes, pipe nipples or stud

ITEM	SUITABLE	Ø	AVAILABLE
74HLR	For tire locks	1	✓



**TWIST SOCKET SET WITH PUNCH**



**14**  
PIECES



• Designed to easily remove damaged, rounded or corroded nuts, wheel lugs, bolts, pipes, pipe nipples or stud

ITEM	SUITABLE	Ø	AVAILABLE
7200S	Extracts bolts from 3/8" to 3/4" and 10 mm to 19 mm	1	On Request



**DOUBLE END TWIST SOCKET SET**



**6**  
PIECES



• Designed to easily remove damaged, rounded or corroded nuts, wheel lugs, bolts, pipes, pipe nipples or stud

ITEM	SUITABLE	Ø	AVAILABLE
7400SWL	Extracts bolts from 17 mm, 3/4" 19 mm, 13/16", 21 mm and 7/8"	1	✓



**JAW AUTO ADJUSTABLE GEAR PULLERS**

**2 OR 3 JAW AUTO ADJUSTABLE GEAR PULLERS**



EXA5



• Quick and easy to use gear puller upto 5X faster than traditional pullers.  
 • Easily removable jaws for setting to required jaw configuration with internal/external setting.  
 • Slim profile of jaws enables convenient access to hard to reach bearings and gears.  
 • Ratchet system holds jaws while adjusting puller.

ITEM	OPENING CAPACITY	MAX. HEIGHT	CAPACITY	Ø	AVAILABLE
EXA2	3-5/32"	3-5/32"	2 tons	1	On Request
EXA5	5-7/8"	5-15/16"	5 tons	1	On Request
EXA7	8-9/16"	8-1/2"	7 tons	1	On Request



**STRAIGHT JAW PULLERS**

**STRAIGHT JAW PULLER TYPE B**



↑ INTERCHANGEABLE AND ADJUSTABLE JAWS

STEEL FORCING SCREW

**20**  
PIECES

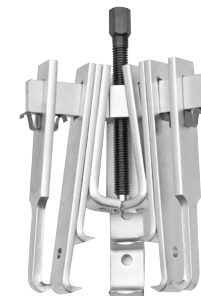

• Treated steel forcing screw; features a hex head that can be turned with socket and ratchet. Has a floating tip that exerts the extraction force.  
 • Forged head made of high-resistance steel.  
 • Die-cut and hardened metal clip holds the jaws to the puller's body.  
 • Interchangeable and adjustable jaws, great for different types of extractions.

ITEM	JAW TYPE	MAX. HEIGHT	Ø	AVAILABLE
4216	Screw head jaw	2-5/8"	1	✓
	Short jaw	4"		
	Long jaw	5-7/16"		
	Thin jaw	5-1/2"		



PULLERS AND CLAMPS

# 12 PULLERS AND CLAMPS

## STRAIGHT JAW PULLERS

### STRAIGHT JAW PULLERS TYPE A

HEAVY DUTY TYPE A 6 T CAPACITY

14 PIECES



IN METAL BOX	
ITEM	4212SJB
PIECES	15
PACKING	
BOX	4019

BULK

ITEM	JAW TYPE	MAX. HEIGHT	AVAILABILITY
4212SJ	Screw head jaw	2-5/8"	•
	Short jaw	4"	•
	Long jaw	5-1/2"	•
	Thin jaw	5-1/2"	•



### BLACK FINISH STRAIGHT JAW PULLER TYPE A 6 TON

HEAVY DUTY ZINC PHOSPHATE FINISH TYPE A 6 T CAPACITY

15 PIECES



• Zinc Phosphate finish for use where non-plated products are required.

METAL BOX

ITEM	JAW TYPE	MAX. HEIGHT	AVAILABILITY
4212SJB	Screw head jaw	2-5/8"	•
	Short jaw	4"	•
	Long jaw	5-1/2"	•
	Thin jaw	5-1/2"	•



PULLERS AND CLAMPS

### STRAIGHT JAW PULLERS TYPE A 6 TON

HEAVY DUTY TYPE A 6 T CAPACITY

12 PIECES



IN METAL BOX	
ITEM	4213B
PIECES	13
PACKING	
BOX	4019

BULK

ITEM	JAW TYPE	MAX. HEIGHT	AVAILABILITY
4213	Screw head jaw	2-5/8"	•
	Long jaw	5-1/2"	•
	Thin jaw	5-1/2"	•



### STRAIGHT JAW PULLERS TYPE A 6 TON

HEAVY DUTY TYPE A 6 T CAPACITY

10 PIECES



IN METAL BOX	
ITEM	4215B
PIECES	11
PACKING	
BOX	4019

BULK

ITEM	JAW TYPE	MAX. HEIGHT	AVAILABILITY
4215	Screw head jaw	2-5/8"	•
	Long jaw	5-1/2"	•



### STRAIGHT JAW PULLERS TYPE A

HEAVY DUTY TYPE A 6 T CAPACITY

8 PIECES



IN METAL BOX	
ITEM	4214B
PIECES	9
PACKING	
BOX	4019

BULK

ITEM	JAW TYPE	MAX. HEIGHT	AVAILABILITY
4214	Short jaw	4"	•
	Long jaw	5-1/2"	•



### REPLACEMENT FOR CROSS BAR 6 TON

HEAVY DUTY



BULK

ITEM	CAPACITY	AVAILABILITY
4211	Cross bar for 6-ton puller	•

### REPLACEMENT FOR FORCING SCREW 6 TON

HEAVY DUTY



BULK

ITEM	DESCRIPTION	AVAILABILITY
4212	Forcing screw for 6-ton puller	•

**STRAIGHT JAW PULLERS**

**REPLACEMENT FOR JAW SAFETY CLIP 6 TON**



**BULK**

ITEM	DESCRIPTION	⊞	AVAILABLE
4211S	Jaw safety clip for 6-ton puller	6	✓

**REPLACEMENTS FOR SHORT JAW 6 TON**



**BULK**

ITEM	TYPE	MAX. HEIGHT	⊞	AVAILABLE
4215Q	Short jaw	4"	1	✓
4216Q	Long jaw	5-1/2"	1	✓
4217Q	Thin jaw	5-7/16"	1	✓
4218Q	Screw head jaw	2-5/8"	1	✓

**BLACK FINISH STRAIGHT JAW PULLERS 10 TON**



**15  
PIECES**



**METAL BOX**

• Zinc Phosphate finish for use where non-plated products are required.

ITEM	JAW TYPE	MAX. HEIGHT	⊞	AVAILABLE
4030BB	Screw head jaw	3"	1	✓
	Short jaw	4-7/8"		
	Double-reach jaw	4-7/8" a 7-7/16"		
	Thin jaw	7-5/16"		

**BLACK FINISH STRAIGHT JAW PULLERS 10 TON**



**13  
PIECES**



**METAL BOX**

• Zinc Phosphate finish for use where non-plated products are required.

ITEM	JAW TYPE	MAX. HEIGHT	⊞	AVAILABLE
4234BB	Screw head jaw	3"	1	✓
	Thin jaw	7-5/16"		
	Double-reach jaw	4-7/8" a 7-7/16"		

**STRAIGHT JAW PULLERS 10 TON**



**14  
PIECES**



**BULK**

ITEM	JAW TYPE	MAX. HEIGHT	⊞	AVAILABLE
4030	Screw head jaw	3"	1	✓
	Short jaw	4-7/8"		
	Double-reach jaw	4-7/8" to 7-7/16"		
	Thin jaw	7-5/16"		

**IN METAL BOX**

ITEM	4030B
PIECES	15



PACKING	BOX	4019
	⊞	1
	AVAILABLE	✓
		•
		•
		•

**STRAIGHT JAW PULLERS 10 TON**



**12  
PIECES**



**BULK**

ITEM	JAW TYPE	MAX. HEIGHT	⊞	AVAILABLE
4234	Screw head jaw	3"	1	✓
	Double-reach jaw	4-7/8" to 7-7/16"		
	Thin jaw	7-5/16"		

**IN METAL BOX**

ITEM	4234B
PIECES	13



PACKING	BOX	4019
	⊞	1
	AVAILABLE	✓
		•
		•
		•

**STRAIGHT JAW PULLERS 10 TON**



**8  
PIECES**



**BULK**

ITEM	JAW TYPE	MAX. HEIGHT	⊞	AVAILABLE
4238	Screw head jaw	3"	1	✓
	Double-reach jaw	4-7/8" to 7-7/16"		

**IN METAL BOX**

ITEM	4238B
PIECES	9



PACKING	BOX	4019
	⊞	1
	AVAILABLE	✓
		•
		•

PULLERS AND CLAMPS

# 12 PULLERS AND CLAMPS

## STRAIGHT JAW PULLERS

### STRAIGHT JAW PULLERS 10 TON

HEAVY DUTY TYPE A 10 T CAPACITY

8 PIECES



• Includes 2 regular jaws and 2 long jaws.

BULK

ITEM	JAW TYPE	MAX. HEIGHT	⊞	AVAILABLE
4232SJ	Short jaw	4-7/8"	1	✓
	Double-reach jaw	4-7/8" to 7-7/16"		•

IN METAL BOX	
ITEM	4232SJB
PIECES	9
PACKING	
BOX	4019
⊞	1
AVAILABLE	✓



### REPLACEMENT FOR CROSS BAR

HEAVY DUTY



BULK

ITEM	CAPACITY	⊞	AVAILABLE
4011	Cross bar for 10-ton puller	1	✓

### REPLACEMENT FOR FORCING SCREW

HEAVY DUTY



BULK

ITEM	DESCRIPTION	⊞	AVAILABLE
4012S	For 10-ton puller	1	✓

### REPLACEMENT FOR JAW SAFETY CLIP

HEAVY DUTY



BULK

ITEM	DESCRIPTION	⊞	AVAILABLE
4011S	For 10-ton puller	1	✓

### REPLACEMENTS FOR THIN JAW 10 TON

HEAVY DUTY



BULK

ITEM	TYPE	MAX. HEIGHT	⊞	AVAILABLE
4015	Short jaw	4-7/8"	1	✓
4016	Double-reach Jaw	4-7/8" to 7-7/16"	1	✓
4017	Thin jaw	7-5/16"	1	✓
4018	Screw head jaw	3"	1	✓

## REVERSIBLE JAW PULLERS

### REVERSIBLE 2-POSITION 2-JAW PULLER

INDUSTRIAL DUTY TYPE A 2 POSITIONS

2 T CAPACITY



### REVERSIBLE 2-POSITION 3-JAW PULLER

INDUSTRIAL DUTY TYPE B 2 POSITIONS

2 T CAPACITY



ITEM	OPENING CAPACITY	MAX. HEIGHT	CAPACITY	⊞	AVAILABLE
4033	4"	3-1/2"	2 tons	1	✓

ITEM	OPENING CAPACITY	MAX. HEIGHT	CAPACITY	⊞	AVAILABLE
4034	4"	3-1/2"	2 tons	1	✓

### REVERSIBLE 2-JAW PULLERS

INDUSTRIAL DUTY TYPE A



### REVERSIBLE 2-POSITION 2 OR 3 JAW PULLERS

INDUSTRIAL DUTY TYPE C 2 POSITIONS



ITEM	OPENING CAPACITY	MAX. HEIGHT	CAPACITY	⊞	AVAILABLE
4044	6"	3-1/2"	5 tons	1	✓
4045	9"	5-1/2"	7 tons	1	✓

ITEM	OPENING CAPACITY	MAX. HEIGHT	CAPACITY	⊞	AVAILABLE
4046	7"	3-1/2"	5 tons	1	✓
4047	10"	5-1/2"	7 tons	1	✓

PULLERS AND CLAMPS

**REVERSIBLE JAW PULLERS**

**REVERSIBLE JAW PULLERS**



107295

ITEM	MAXIMUM OPENING	MAX. HEIGHT	CAPACITY	⊞	AVAILABLE
107295	3"	4-1/16"	2 Tons	1	On Request
107296	4"	4-11/32"	3 Tons	1	On Request

**HEAVY-DUTY FIXED JAW PULLERS**

**FIXED JAW PULLERS**



43602

• Straight jaws easy to adjust.

ITEM	MAX. EXTERNAL DIAMETER	MAX. INTERNAL DIAMETER	CAPACITY	⊞	AVAILABLE
43601	2-3/8"	3-3/16"	1 t	1	✓
43602	3-3/16"	5-1/8"	2 t	1	✓
43610	6-1/8"	8-3/4"	10 t	1	✓
43615	7-11/16"	10-3/8"	15 t	1	✓
43620	9-13/16"	13-3/16"	20 t	1	✓

**BULK**

**WORKBENCHES**

**PORTABLE WORKBENCH**



• Clamp for regular workpieces.



• Extendible press which can hold extra wide (37") workpieces.

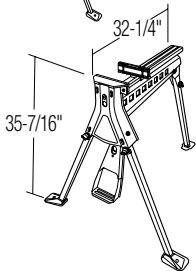

- All steel construction for greater durability and better resistance.
- Progressive jaw advancement; its foot-pedal operated clamp/unlock, secures workpiece in place.



ITEM	CLAMPING RANGE	CLAMPING JAW SIZE	MAXIMUM LOAD	⊞	AVAILABLE
BT900	0 - 37 7/16"	8" x 3" x 0.3"	330 lb	1	✓

**PORTABLE WORKBENCH**

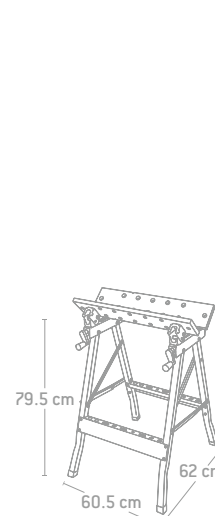

- Space-saving workbench, ideal for storage and transport.
- Use it for cutting, clamping, sawing, painting, and more.



ITEM	CLAMPING RANGE	SIZE OF EACH BASE	MAXIMUM LOAD	⊞	AVAILABLE
BT600	0 - 9-7/16"	60.5" x 4.75" x 0.70"	220 lb	1	On Request

**CLAMPS**

**PRECISION MILLING VISES**



45106

45202

45305

- Provides a stable, precise clamping mechanism that prevents any movement of the workpiece, ensuring accuracy and repeatability during milling, drilling, or other machining processes.

ITEM	45103	45106	45202	45203	45204	45205	45206	45305	45306
JAW WIDTH	3"	6"	2"	3"	4"	5"	6"	5"	6"
JAW DEPTH	1-1/2"	1-3/4"	1"	1-5/16"	1-1/2"	1-3/4"	1-3/4"	1-3/4"	1-3/4"
AXIS	1	1	2	2	2	2	2	3	3
⊞	1	1	1	1	1	1	1	1	1
AVAILABLE	✓	✓	On Request	✓	On Request	On Request	✓	✓	✓

# 12 PULLERS AND CLAMPS

## CLAMPS

### DRILL PRESS VISES

**INDUSTRIAL DUTY** **HIGH STRENGTH MALLEABLE CAST IRON**



• 4 wide mounting holes



• Fixed jaw with 3 longitudinal and 1 transversal prisms for firm gripping of round stock both horizontally and vertically



PMOR1



PMOR3

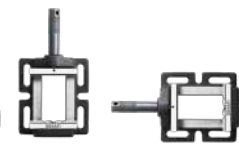

• 3 mounting options useful drilling along all axes with a single setting of the job and holding of long workpieces which are cumbersome and difficult to manage in regular vises.

- Low profile & compact vises are suitable for use with drill stands, bench drills and drill presses in metal and woodworking applications.
- Spindle moves inside the hollow hand grip making the vise usable on any position across the table.



ITEM	JAW LENGTH	MAXIMUM OPENING	JAW DEPTH	POSITIONS	☞	AVAILABLE
PMOR1	4"	3-5/8"	1-3/16"	1	1	On Request
PMOR3	4"	3-1/2"	1-3/16"	3	1	On Request

### FORGED C-CLAMPS

**HEAVY DUTY**

**INDUSTRIAL DUTY**

**INDUSTRIAL DUTY**

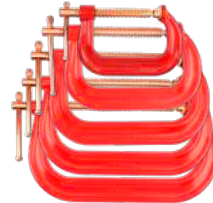

- More robust body with corner reinforcements for greater tightening strength.
- Larger diameter screw.
- Easy-to-operate sliding T-handle.
- ACME thread for easy turning.
- Powder-coated to prevent corrosion.



- Copper-plated screw resists weld spatter and corrosion.
- Its design provides a deeper throat for greater reach.
- Easy-to-operate sliding "T" handle.
- ACME thread for easy turning.
- Powder-coated to prevent corrosion.



- Their design provides a deeper throat for greater reach.
- Easy-to-use sliding T-handle.
- Powder-coated to prevent corrosion.



ITEM	MAXIMUM OPENING	THROAT DEPTH	☞	AVAILABLE
404PRO	4"	2"	1	On Request
406PRO	6"	2-3/4"	1	On Request
408PRO	8"	3-3/4"	1	On Request
410PRO	10"	4-7/8"	1	✓
412PRO	12"	5-1/8"	1	On Request

ITEM	MAXIMUM OPENING	THROAT DEPTH	☞	AVAILABLE
404W	4"	2-3/4"	1	On Request
406W	6"	3-5/8"	1	On Request
408W	8"	4-1/2"	1	On Request
410W	10"	5-3/8"	1	On Request
412W	12"	5-3/4"	1	On Request

ITEM	MAXIMUM OPENING	THROAT DEPTH	☞	AVAILABLE
402	2"	2"	1	On Request
403	3"	2-3/8"	1	On Request
404	4"	2-3/4"	1	On Request
406	6"	3-5/8"	1	On Request
408	8"	4-1/2"	1	On Request
410	10"	5-3/8"	1	On Request
412	12"	5-3/4"	1	On Request

### FORGED C-CLAMPS

**MASTER USE**

**SURTEK**  
TOOLS FOR SPECIALISTS

**INDUSTRIAL DUTY**

**URREA**  
SUPERIOR QUALITY AFFORDABLE TOOLS

**PROFESSIONAL USE**

**SURTEK**  
TOOLS FOR SPECIALISTS

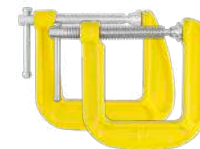
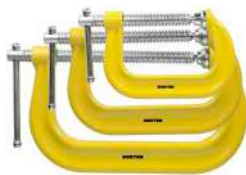

- Easy-to-use sliding T-handle.
- Electrostatic paint to prevent corrosion.



- More robust body with corner reinforcements for greater clamping force.
- Easy-to-operate sliding T-handle.
- Powder-coated to prevent corrosion.



ITEM	MAXIMUM OPENING	THROAT DEPTH	☞	AVAILABLE
107064	4-1/8"	105 mm	2-7/8" 73 mm	1 On Request
107066	6-1/8"	156 mm	3-3/4" 95 mm	1 On Request
107068	8-1/8"	206 mm	4-5/8" 117 mm	1 On Request

ITEM	MAXIMUM OPENING	THROAT DEPTH	☞	AVAILABLE
PRC4	4"	2-3/16"	1	On Request
PRC5	5"	2-9/16"	1	On Request
PRC6	6"	2-13/16"	1	On Request
PRC8	8"	3-1/4"	1	On Request
PRC10	10"	3-5/8"	1	On Request
PRC12	12"	4"	1	On Request

- Their design provides a deeper throat for greater reach.
- Easy-to-operate sliding T-handle.
- Powder-coated to prevent corrosion.



ITEM	MAXIMUM OPENING	THROAT DEPTH	☞	AVAILABLE
107142	2-1/2"	63.5 mm	2-1/4" 57 mm	1 On Request
107143	3"	76.2 mm	4-1/4" 107.5 mm	1 On Request

CLAMPS

DUCTILE IRON C-CLAMPS



- Easy-to-use sliding T-handle.
- Electrostatic paint to prevent corrosion.

ITEM	MAXIMUM OPENING	THROAT DEPTH	☞	AVAILABLE
107051	1" 25 mm	31/32"	1	On Request
107052	2" 51 mm	1-1/4"	1	On Request
107053	3" 76 mm	1-3/8"	1	On Request
107054	4" 102 mm	1-5/8"	1	On Request
107055	5" 127 mm	2-7/16"	1	On Request
107056	6" 152 mm	2"	1	On Request
107058	8" 203 mm	2-7/8"	1	On Request

F-CLAMPS



- Trapezoidal thread totally sealed and permanently lubricated.

- Hardened steel brake.

- Ball bearings mechanism brings more clamping force with best effort.

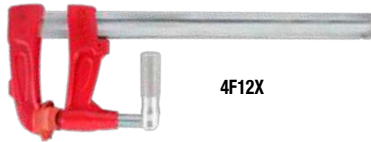

4F12X

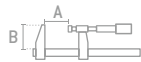

- Nodular casting jaws.
- Ergonomic aluminium handle with multiple positions.
- High resistance H-shape steel bar.
- 2200 lb maximum Clamping force.
- Includes PVC jaw protector pads.

ITEM	MAXIMUM OPENING	THROAT DEPTH	☞	AVAILABLE
4F12X	12"	4,22"	1	✓
4F18X	18"	5"	1	✓
4F24X	24"	5"	1	✓

RATCHETING F-CLAMPS



4FM12



- Ratcheting system for easy adjustment and quick release.
- Width opening capacity.
- 900 lb maximum clamping force.

ITEM	MAXIMUM OPENING	THROAT DEPTH	☞	AVAILABLE
4FM12	11-1/2"	5-1/2"	1	On Request
4FM24	23-1/2"	5-1/2"	1	On Request

STAMPED C-CLAMPS



- Made of sheet metal with ribbing on the sides for added strength.
- Easy-to-use sliding "T" handle.

ITEM	MAXIMUM OPENING	THROAT DEPTH	☞	AVAILABLE
107092	2' 50 mm	1-3/8"	1	On Request
107093	3' 76 mm	1-9/16"	1	On Request
107094	4' 101 mm	1-3/4"	1	On Request

F-CLAMPS



107115

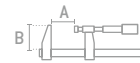

- Cold-drawn rail grooved on both sides.
- Clamps with plastic protection to prevent damage to the material being held.

ITEM	MAXIMUM OPENING	THROAT DEPTH	☞	AVAILABLE
107114	4" 100 mm	2"	1	On Request
107115	6" 150 mm	2"	1	On Request
107116	8" 200 mm	2"	1	On Request
107117	10" 250 mm	2"	1	On Request
107118	12" 300 mm	2"	1	On Request

QUICK RELEASE BAR CLAMPS



PRP6



- Reversible design to compress or separate objects.
- Quick-release system for rapid release.
- PVC jaws with large contact area.
- Non-slip handles.

ITEM	MAXIMUM OPENING	THROAT DEPTH	☞	AVAILABLE
PRP6	6"	2-1/2"	1	On Request
PRP12	12"	2-1/2"	1	On Request
PRP24	24"	2-1/2"	1	On Request

# 12 PULLERS AND CLAMPS

## CLAMPS

### QUICK RELEASE BAR CLAMPS

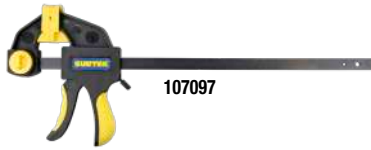

107097

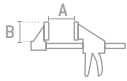

- Quick release system for rapid release.
- Non-slip handles.



ITEM	MAXIMUM OPENING		THROAT DEPTH	☞	AVAILABLE
107096	6"	152 mm	2-1/8"	1	On Request
107097	12"	305 mm	2-1/8"	1	On Request
107098	24"	609 mm	2-1/8"	1	On Request

### SPRING CLAMPS



PRES2

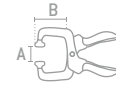

- Ratchet system generates adjustable clamping pressure.
- Flexible TPU jaws for gripping non-parallel surfaces.
- Quick-release system.
- Non-slip handles.



ITEM	MAXIMUM OPENING	THROAT DEPTH	☞	AVAILABLE
PRES2	2"	3"	1	On Request
PRES4	4"	4"	1	On Request

### SPRING CLAMPS



PR150

PR225

PR300

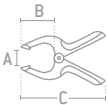

- High-impact polypropylene movable jaw.
- High-tension spring.
- Non-slip handles.



ITEM	MAXIMUM OPENING	THROAT DEPTH	TOTAL LENGTH	☞	AVAILABLE
PR150	1-1/2"	1-9/16"	4"	4	On Request
PR225	2-1/4"	2-3/8"	6"	4	On Request
PR300	3"	3-9/64"	8"	4	On Request

### 3/4" PIPE CLAMP



- Made of malleable steel.
- Quick-release plates.
- Unique design for greater stability.
- Works with any 3/4" galvanized pipe.



ITEM	DESCRIPTION	☞	AVAILABLE
107111	For 3/4" pipes	4	On Request

**URREA**  
SUPERIOR QUALITY AFFORDABLE TOOLS



usa.urrea.com



**WORKBENCH VISES**

**WORKBENCH VISES**



URREA



**424XP**



• 4 mounting holes.



• Hardened steel pipe jaws to hold pipes from 1/4" to 2-1/2".

- 60,000 psi construction design.
- 30KN maximum clamping force.



ITEM	424XP	425XP	426XP	428XP
JAW WIDTH	4-1/2"	5-1/2"	6-1/2"	8"
MAXIMUM OPENING	4-1/2"	5-1/2"	6-1/2"	8"
THROAT DEEP	3-1/2"	3-3/4"	4"	7-1/2"
PIPE JAW CAPACITY	2-1/2"	3"	3-1/2"	
☞	1	1	1	1
AVAILABLE	On Request	On Request	On Request	On Request

**WORKBENCH VISES**



URREA

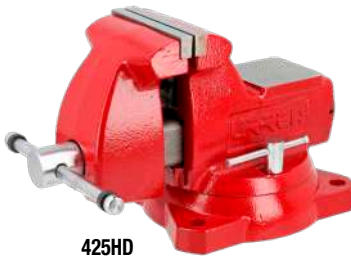

**425HD**



• 4 mounting holes.



• Hardened steel pipe jaws to hold pipes from 1/4" to 2-1/2".

- Lifetime lubrication: grease is permanently sealed in for trouble-free service.
- Heavy-duty casting are build for rugged use and extended life.



ITEM	424HD	425HD	426HD	427HD
JAW WIDTH	4"	5"	6"	8"
MAXIMUM OPENING	4-1/4"	5-15/64"	5-63/64"	8-1/2"
THROAT DEEP	3-27/64"	3-47/64"	4-9/64"	4-31/64"
PIPE JAW CAPACITY	1/4" a 2"	1/4" a 2-1/2"	1/4" a 2-1/2"	1/4" a 2-1/2"
☞	1	1	1	1
AVAILABLE	On Request	On Request	On Request	On Request



**427HDK**



**42HDK**

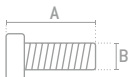

- Serrated machinist jaws provides excellent grip for holding objects.
- Includes one pair of jaws with mounting screws.



ITEM	424HDK	425HDK	426HDK	427HDK	42HDK
<b>Replacement jaws</b>					
FOR MODEL	424HD	425HD	426HD	427HD	424HD, 425HD, 426HD, 427HD
DISTANCE BETWEEN HOLES	2-1/2"	2-1/2"	4"	4"	N/A
SCREW (A)	7/16"	7/16"	1/2"	1/2"	1/2"
MEASUREMENT (B)	3/16"	3/16"	1/4"	1/4"	3/16"
SCREWS INCLUDED	2	2	2	2	2
JAWS INCLUDED	2 (1 par)	2 (1 par)	2 (1 par)	2 (1 par)	2 (1 par)
☞	1	1	1	1	1
AVAILABLE	On Request	On Request	On Request	On Request	On Request

## WORKBENCH VISES

### WORKBENCH VISES

INDUSTRIAL DUTY 360° SWIVEL BASE

URREA



424N



• 4 mounting holes.

- Made of maleable cast iron.
- Pipe clamp for up to 2" diameter.
- Forged jaws.



PULLERS AND CLAMPS

CARBON STEEL DIAMOND TEXTURE FINE POLISH



424NK

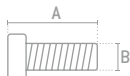

- Made from hardened steel.
- Serrated machinist jaws provides excellent grip for holding objects.



### MULTIPURPOSE BENCH VISE

INDUSTRIAL DUTY 360° SWIVEL BASE

URREA



• 4 mounting holes.

- Jaw rotation 90° left and right.
- Ideal for holding objects at any angle.
- 3 jaw types allow for gripping any geometry.



ITEM	425MP
JAW WIDTH	5"
MAXIMUM OPENING	5"
THROAT DEEP	2-5/8"
PIPE JAW CAPACITY	2"
☞	1
AVAILABLE	On Request

ITEM	424N	425N	426N	428N
JAW WIDTH	4"	5"	6"	8"
MAXIMUM OPENING	4-1/4"	5-15/64"	5-63/64"	8-1/2"
THROAT DEEP	3-27/64"	3-47/64"	4-9/64"	4-31/64"
PIPE JAW CAPACITY	1/4" a 2"	1/4" a 2"	1/4" a 2"	1/4" a 2"
☞	1	1	1	1
AVAILABLE	On Request	On Request	On Request	On Request



ITEM	424NK	425NK	426NK	428NK
<b>Replacement jaws</b>				
FOR SCREW	424N	425N	426N	428N
DISTANCE BETWEEN HOLES	2-1/2"	2-1/2"	4"	4"
SCREW (A)	1/2"	1/2"	1/2"	1/2"
MEASUREMENT (B)	3/16"	3/16"	1/4"	1/4"
SCREWS INCLUDED	2	2	2	2
JAWS INCLUDED	2 (1 par)	2 (1 par)	2 (1 par)	2 (1 par)
☞	1	1	1	1
AVAILABLE	On Request	On Request	On Request	On Request

### WORKBENCH VISES

PROFESSIONAL USE 360° SWIVEL BASE

SURTEK



107026

- High resistance to heavy-duty work.
- With steel guide and high-strength gray iron body.



ITEM	JAW WIDTH	MAXIMUM OPENING	THROAT DEPTH	☞	AVAILABLE
107024	4"	4"	2-1/4"	1	On Request
107025	5"	5"	2-5/8"	1	On Request
107026	6"	6"	3"	1	On Request
107028	8"	8"	3-1/2"	1	On Request
107030	10"	10"	4"	1	✓



CLASS	TYPE	PAGE	BRAND	
			URREA	SURTEK
Automotive tools	Towing accessories	370		•
	Bodywork	371	•	•
	Hydraulic body repair kits	372	•	•
	Steering tools	373	•	•
	Brake tools	374	•	•
	Wheel tools	376	•	•
	Oil filter & accesories tools	380	•	
	Mechanic's plier	380	•	
	Engine tools and accessories	382	•	•
	Blade feeler	385	•	•
	Bus & cross lug nut wrenches	393	•	•
	Electrical system	395	•	•
	Suspension tools	396	•	•
	Mechanic benches and creepers	397	•	•
	General use automotive tool	399	•	•
Hydraulic and lifting equipment	Floor jack	402	•	
	Bottle jack	403	•	•
	Cranes	408	•	•
	Transmission jacks	408	•	•
	Hydraulic shop presses	411	•	•
	Jack stands	412	•	•

[usa.urrea.com](http://usa.urrea.com)

We are constantly improving our products, that is why the information, characteristics and availability of them can change without prior notice.

## TOWING ACCESSORIES

### TYPE "A" TRAILER COUPLERS



NEW



- Made of 9-gauge steel.
- Manual operation safety latch
- Compatible with trailer hitch balls.
- For connecting a trailer to the vehicle.



ITEM	SIZE	WORKING LOAD LIMIT		DIMENSIONS	⊞	AVAILABLE
		KG	LB			
ARE3	2"	2,270	5,000	9.2" x 2.3" x 12.3"	1	On Request
ARE4	2-5/16"	4,536	10,000	14.4" x 4" x 9.4"	1	On Request

### HITCH BALLS



NEW

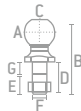

- Made of alloy steel
- Mirror-polished finish.
- Includes fine-thread nut for optimum fastening.



ITEM	SIZE							WORKING LOAD LIMIT		⊞	AVAILABLE
	BALL SIZE (A)	(B)	(C)	(D)	(E)	(F)	(G)	KG	LB		
BORE3	1 7/8"	5.08"	1.54"	2.48"	2.17"	0.98"	0.31"	1,587	3,500	1	On Request
BORE4	2"	4.41"	1.57"	1.77"	1.46"	0.75"	0.31"	1,587	3,500	1	On Request
BORE6	2-5/16"	5.20"	1.97"	2.09"	1.77"	0.98"	0.31"	2,721	6,000	1	On Request

### SWIVEL-LOCK TRAILER TONGUE PINS



NEW

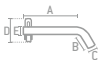

- Swivel lock that replaces traditional clevis-pin setups.
- Lock eye for added security.
- Made of high-strength steel.
- Heavy-duty safety pin for secure fastening.
- For securing the trailer tongue.



ITEM	SIZES					⊞	AVAILABLE
	(A)	(B)	(C)	(D)	(E)		
PEL12	3.94"	1.30"	0.50"	1.57"	0.50"	1	On Request
PEL58	4.72"	1.42"	0.62"	1.77"	0.62"	1	On Request

### BALL MOUNT



NEW

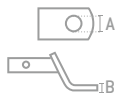

- 2" x 2" shank.
- Drop ball mount.
- Easy installation and handling.
- Made of high-strength steel.
- For connecting a trailer to the vehicle.
- Can be mounted on most vehicles.



ITEM	CAPACITY	DROP	CLASS	HOLE DIAMETER (A)	PLATE THICKNESS (B)	COMPATIBLE WITH ITEMS	⊞	AVAILABLE
LENG2	5,000 lb	2"	III	1.02"	0.78"	BORE3 - 151228 - BORE4 151227 - BORE6	1	On Request
LENG4	6,000 lb	4"	III	1.02"	0.78"		1	On Request

**TOWING ACCESSORIES**

**SINGLE TRAILER HOOK**



- Forged steel.
- Chrome-plated finish.
- For mounting on front and rear bumper.



ITEM	HOOK STYLE	DIMENSIONS	⊞	AVAILABLE
151230	Single	4.41" x 2.20" x 2.56"	1	On Request

**TOW STRAP**



- Ideal for automobiles, boats, tractors and various vehicles.
- Forged-steel hooks with spring-loaded safety latches.
- Strap made of 100% polyester.



ITEM	MM	WIDTH	PULG	MM	LENGTH		WORKING LOAD LIMIT		⊞	AVAILABLE
					FT	KG	LB			
151212	50 mm		2"	5.8 m		19 ft	2,000	4,400	1	On Request

**TOW ROPES**



- Ideal for automobiles, boats, tractors and various vehicles.
- Forged-steel hooks with spring-loaded safety latches.
- Rope made of 100% polyethylene.



ITEM	MM	WIDTH	PULG	MM	LENGTH		WORKING LOAD LIMIT		⊞	AVAILABLE
					FT	KG	LB			
151210	16 mm		5/8"	3.5 m		11.5 ft	1,000	2,200	1	On Request
151211	22 mm		7/8"	4.5 m		14.7 ft	1,500	3,300	1	On Request

**BODYWORK**

**BODY REPAIR HAMMER SET**



**11  
PIECES**



Content	
Ergonomic rubber handle hammer	1
Multishape Dolly	1
Angled groove head	1
End small curve	1
Square face	1
Cross curve	1
Round face	1
Multi curve	1
Bullet peen	1
Ball Peen	1
Pick peen	1

- Hammer with interchangeable head system.

ITEM	PIECES	⊞	AVAILABLE
MDHK	11	1	On Request

**DOLLY BLOCKS**



- Handle design allows access to hard-to-reach areas.
- Can be used as a lever.
- Forged from high-carbon steel, hardened and tempered.
- Provides a complete solution in panel and paint shops for chassis and body repair.



ITEM	TYPE	WEIGHT	FINISH	⊞	AVAILABLE
1456	Combination spoon	42.32 oz	Polished with black handle	1	✓

## BODYWORK

### BODYWORK HAMMERS WITH FIBERGLASS HANDLE



URREA

IMPROVED PRODUCT

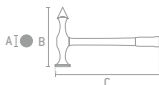

1424FV

- Flat round face and flat square face ideal to smooth damaged metal surfaces, especially at corners.



1427FV

- Flat round face and flat square face ideal to smooth damaged metal surfaces, especially at corners.



1428FV

- Pick hammer with flat face and long pick great for leveling dents in sheet metal and deep areas.

BULK

ITEM	DESCRIPTION	FACE DIAMETER (A)	HEAD LENGTH (B)	TOTAL LENGTH (C)	☞	AVAILABLE
1424FV	With fiberglass handle, for smooth finishes	1-1/4"	4"	13"	1	✓
1427FV	With fiberglass handle, for finishes	1-3/8"	4-1/2"	13"	1	✓
1428FV	With fiberglass handle, for sheet straightening	1-3/8"	5-7/8"	13"	1	✓

### BODYWORK HAMMERS WITH WOODEN HANDLE



URREA

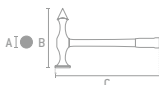

1421

- Flat round face and narrow peen ideal for edge and molding finishes.



1424

- Flat round face and flat square face ideal for smoothing damaged metal surfaces, especially at corners.



1427

- Flat round face and narrow peen ideal for edge and molding finishes.



1428

- Pick hammer with flat face and long pick excellent for leveling dents in sheet metal and deep areas.

BULK

ITEM	DESCRIPTION	FACE DIAMETER (A)	HEAD LENGTH (B)	TOTAL LENGTH (C)	☞	AVAILABLE
1421	Two head wood handle, for sheet straightening	1-1/4"	6"	13-3/4"	1	✓
1427	With wood handle, for finishes	1-3/8"	4-1/2"	12-1/4"	1	✓
1424	With wood handle, for smooth finishes	1-1/4"	4"	13"	1	✓
1428	One head wood handle, for sheet straightening	1-1/2"	5-7/8"	14"	1	✓

### HYDRAULIC BODY REPAIR KIT



URREA



14  
PIECES

- Safety valve against overload.
- Hydraulic stroke limitation.



- For body repairs, rescue work or for any push application, separation, traction or elevation that requires hydraulic power.



ITEM	CAPACITY	PISTON DISPLACEMENT	MINIMUM PISTON LENGTH	MAXIMUM LIFTING HEIGHT	WORK PRESSURE	OIL CAPACITY	☞	AVAILABLE
2481	20 t	5.1"	14.3"	19.4"	5003.8 psi	13.53 fl oz	1	On Request

**BODYWORK**

**HYDRAULIC BODY REPAIR KITS**



**10 T**  
CAPACITY

**14**  
PIECES

- Safety valve against overload.
- Hydraulic stroke limitation.



**ECA10**

**4 T**  
CAPACITY

**14**  
PIECES

- Safety valve against overload.
- Hydraulic stroke limitation.



**ECA4**

**URREA**



**NEW**

- Made of nodular cast iron for greater durability and impact resistance.
- Reinforced pump and cylinder.
- Extensions and accessories made of nodular iron.
- Plastic case for better storage.

- Improved equipment performs the same job with lower pressure.

ITEM	CAPACITY	PISTON DISPLACEMENT	MINIMUM PISTON LENGTH	MAXIMUM LIFTING HEIGHT	WORK PRESSURE	OIL CAPACITY	⊞	AVAILABLE
<b>ECA10</b>	10T	5.91"	4.72"	10.63"	8,936.4 psi	16.91 fl oz	1	On Request
<b>ECA4</b>	4T	4.72"	5.91"	14.96"	9,235.6 psi	9.47 fl oz	1	On Request

**HYDRAULIC BODY REPAIR KITS**



**20 T**  
CAPACITY

**16**  
PIECES

- Safety valve against overload.
- Hydraulic stroke limitation.



**EQC20**

**10 T**  
CAPACITY

**14**  
PIECES

- Safety valve against overload.
- Hydraulic stroke limitation.



**EQC10**

**4 T**  
CAPACITY

**14**  
PIECES

- Safety valve against overload.
- Hydraulic stroke limitation.



**EQC4**

**SURTEK**



**NEW**

- Made of nodular iron for durability and resistance to impact.
- Reinforced pump and cylinder.
- Extensions and accessories made of carbon steel.
- Plastic storage case (EQC4 & EQC10).
- EQC20 includes a metal case for easier transport and storage.

ITEM	CAPACITY	PISTON DISPLACEMENT	MINIMUM PISTON LENGTH	MAXIMUM LIFTING HEIGHT	WORK PRESSURE	OIL CAPACITY	⊞	AVAILABLE
<b>EQC20</b>	20 t	5.31"	15.35"	16.14"	8,267.17 psi	60.87 fl oz	1	On Request
<b>EQC10</b>	10 t	5.00"	13.19"	18.19"	8,992.36 psi	14.71 fl oz	1	On Request
<b>EQC4</b>	4 t	4.72"	11.02"	15.75"	8,122.13 psi	10.31 fl oz	1	On Request

**STEERING TOOLS**

**CLAMPS FOR BALL JOINTS, TRUCK BRAKE LENGTH PINS, AND UNIVERSAL JOINTS**



**7**  
PIECES



Content	
76 mm Tube	1
63 mm Tube	1
51 mm Tube	1
Adapter for 22.2 mm Screw	1
Frame Adapter	1
1/2" Screw	1
Frame	1

- Ideal for assembling and disassembling U-joints and brake anchor pins.
- Forged single-piece arm with satin finish for greater strength.

**URREA**



**WRACK WRENCH**

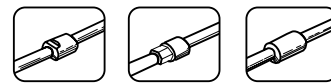

Flat

Hex

Round



- Compatible with hexagonal, flat, and round tie rods.
- Fits hex sizes from 31 mm to 35.5 mm.
- Useful for servicing inner tie rods during automotive maintenance.

**URREA**



ITEM	PIECES	⊞	AVAILABLE	ITEM	TIE RODS CAPACITY	⊞	AVAILABLE
<b>2325</b>	7	1	✓	<b>2381</b>	1-9/32" to 1-5/8"	1	✓

## STEERING TOOLS

### BALL JOINT SEPARATORS AND ACCESSORIES SET



**5  
PIECES**

Content	
Track rod separator 11/16"	1
Ball joint separator 15/16"	1
Pitman arm separator 1-1/8"	1
Manual bar 8"	1
7" Bar for Pneumatic Tool with 13/32" Shank Adapter	1



- Forged alloy steel for durability.
- Versatile design adapts to 3 different forks.
- Ideal for separating tie rods, ball joints, and Pitman arms.
- Includes adaptors for impact and pneumatic use.
- Chrome or phosphate finish for corrosion resistance (depending on model).



ITEM	LENGTH	AVAILABLE
888	22-3/64"	559.96 mm 1 On Request

### FORK SEPARATORS



107251

- Ideal for separating steering tie rods



107252

- Ideal for separating steering ball joints from the steering knuckle

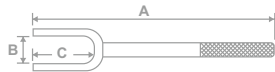

- Ideal for separating steering ball joints from the knuckle.
- Also useful for tie rod separation.

ITEM	TYPE	A		B		C		AVAILABLE
		inches	mm	inches	mm	inches	mm	
107251	Tie rod	15-25/32"	401	23/32"	18	2-13/16"	71	1 ✓
107252	Ball joint	11-13/16"	300	15/16"	24	2-7/8"	73.5	1 ✓

### BRAKE DRUM POLISHER SET



- Flexible shaft with tension adjustment.
- Body design protects the stone during use and eases insertion into cylinders.
- Removes all impurities from brake drums.
- Collar design prevents stone breakage.



ITEM	MINIMUM OPENING		MAXIMUM OPENING		AVAILABLE
	inches	mm	inches	mm	
2392	1-1/4"	31.75	3-1/2"	89	1 ✓

### REPLACEMENT STONE PADS



**3  
PIECES**



Replacement stone pads

ITEM	FOR ITEM	AVAILABLE
2392A	2392	1 ✓

### PICKLE FORK SET



**5  
PIECES**

Content	
Pack rod separator 11/16"	1
Ball joint separator 15/16"	1
Pitman arm separator 1-1/8"	1
Manual bar 8"	1
7" Pneumatic Tool Bar with 13/32" Shank Adapter	1



- Useful for separating steering terminals, ball joints, and Pitman arms.
- Includes adaptors for pneumatic and impact use.
- Satin finish extends tool life.
- Plastic storage case.



ITEM	PIECES	AVAILABLE
107253	5	1 On Request

### BRAKE TOOLS

#### HAND VACUUM PUMP KIT



**7  
PIECES**



- Portable vacuum pump, compact design, one-hand operation.
- Allows static tests and monitoring of vacuum-operated components.
- Enables brake bleeding by a single operator.



ITEM	VACUUM CAPACITY	CONTAINER CAPACITY	AVAILABLE
2012	0-30 inHg	4 fl oz	1 ✓

### BRAKE DRUM POLISHER SET



- Flexible shaft with tension adjustment.
- Body design protects the stone during use and eases insertion into cylinders.
- Removes all impurities from brake cylinders.



ITEM	MINIMUM OPENING		MAXIMUM OPENING		AVAILABLE
	inches	mm	inches	mm	
107202	1/2"	13	2-1/2"	63	4 On Request
107203	3/4"	19	2-1/2"	63	1 On Request
107204	1-1/4"	32	3-1/2"	89	1 On Request

### REPLACEMENT STONE PADS



**3  
PIECES**



107206

Replacement stone pads

ITEM	FOR ITEMS	AVAILABLE
107206	107202	6 On Request
107209	107203	6 On Request
107212	107204	6 On Request



**BRAKE TOOLS**

**DRUM BRAKE ADJUSTING TOOL**



- For adjusting star wheels in rear-wheel-drive vehicles.

ITEM	LENGTH		⊞	AVAILABLE
	in	mm		
2007	7-1/4"	184.2	1	✓
2006	9"	228.6	1	On Request

**BRAKE SPRING PLIERS**



- Compresses springs in automotive brakes.
- Handles designed for easy removal and installation of springs on anchor posts.
- Forged steel construction with satin finish for corrosion protection.

ITEM	LENGTH		MIDDLE JAW OPENING		⊞	AVAILABLE
	in	mm	in	mm		
217	13-1/4"	336.5	13/16"	21	1	✓

**BRAKE SPRING PLIERS**



- Compresses springs in automotive brakes.
- Handles designed for easy removal and installation of springs on anchor posts.
- Forged steel construction with satin finish for corrosion protection.

ITEM	LENGTH		MIDDLE JAW OPENING		⊞	AVAILABLE
	in	mm	in	mm		
107200	32"	810.8	13/16"	21	1	✓

**BRAIN SPRING WASHER TOOL**



- Fits both small and large washers.
- Wide window allows clear visualization of bolt alignment with washer slot.

ITEM	LENGTH		MINIMUM OPENING		MAXIMUM OPENING		⊞	AVAILABLE
	inches	mm	inches	mm	inches	mm		
2011	5-1/4"	133.3	7/8"	22.2	11/16"	18	1	✓

**BRAKE SHOE RETAINER SPRING TOOL**



- Fits both small and large washers.
- Wide opening allows clear view of bolt alignment with washer slot.

ITEM	LENGTH		MINIMUM OPENING		MAXIMUM OPENING		⊞	AVAILABLE
	inches	mm	inches	mm	inches	mm		
107216	7 - 1/64"	178	5/8"	158	7/8"	222	1	On Request

**BRAKE LINING THICKNESS GAUGES**



Color	Size
Green	8 mm 0.315 in
Good condition.	10 mm 0.394 in
	12 mm 0.472 in
	4 mm 0.157 in
Yellow Caution.	5 mm 0.197 in
	6 mm 0.236 in
Red Service needed.	2 mm 0.079 in
	3 mm 0.118 in

Thickness gauge coded by color to know the condition of the Brake lining.



- Color-coded thickness gauges to easily check brake lining condition.
- Made of steel with electrostatic paint coating.

ITEM	DESCRIPTION	⊞	AVAILABLE
2337	Brake lining thickness gauge, 8 pieces	1	✓

**UNIVERSAL BRAKE CALIPER SOCKET BIT SET**



**9** PIECES

Item	Tip size	Tip type	Measure
523940W	3/8"	★	T40
523945W	3/8"	★	T45
543950W	1/2"	★	T50
543955W	1/2"	★	T55
04/01/90	3/8"	●	1/4"
08/03/90	3/8"	●	3/8"
49907M	3/8"	●	7 mm
49908M	3/8"	●	8 mm
499010M	3/8"	●	10 mm



- Includes multiple socket bits for servicing brake calipers.

ITEM	PIECES	⊞	AVAILABLE
5254TH	9	1	On Request

**REAL DISC BRAKE CALIPER KIT**



**6** PIECES



- For vehicles with rear disc brakes (2 or 4 pistons).
- Includes hex 13/16" (20.6 mm) to apply counterhold with a wrench.

ITEM	ADAPTERS	⊞	AVAILABLE
2013	1-1/2", 1-5/8", 1-7/8", 2-1/8", 2-1/2"	1	✓

**DISK BRAKE PISTON TOOL**



- For cars with disc brakes on all four wheels.
- Works with 6 different piston cavity designs.
- 3/8" square drive for use with ratchet and extension.

ITEM	SQUARE	⊞	AVAILABLE
107218	3/8"	1	On Request

**HOSE PINCH PLIERS**



- Made of high-strength synthetic polymer with spring and lock.
- Easy to use and manually release.

ITEM	LENGTH		CAPACITY		⊞	AVAILABLE
	inches	mm	inches	mm		
255G	10"	254	3/4" to 2-1/4"	19 to 57.1	1	On Request

**HOSE CLAMPS**



- Made of high-strength steel.
- Designed to safely pinch fuel, vacuum, and other hoses without damage.

ITEM	inches	CAPACITY	mm	⊞	AVAILABLE
2379	7/8"		22.2	1	On Request

AUTOMOTIVE AND HYDRAULIC TOOLS

## BRAKE TOOLS

### HEAVY-DUTY DISC BRAKE PAD SPREADER



- For brake pads activated by one, two, or four pistons.
- Prevents piston misalignment.
- 360° rotating ratchet handle adapts to any brake system.
- Reversible ratchet facilitates piston compression and release.



ITEM	MAXIMUM OPENING		WIDTH		AVAILABLE
	inches	mm	inches	mm	
2010H	2-3/4"	70	4-1/2"	114.3	1 ✓

### DISC BRAKE PAD SPREADER



- For use in most cars and light trucks.
- Made of high-hardness alloy steel, resistant to deformation.



ITEM	MAXIMUM OPENING		WIDTH		AVAILABLE
	inches	mm	inches	mm	
2010	4-1/2"	114.3	4"	101.6	1 ✓

### PAD SPREADER FOR DISC BRAKE



- For most cars and small trucks.
- Heavy-duty, easy-grip knob.
- Compresses the disc brake piston for easy pad installation.



ITEM	MAXIMUM OPENING		WIDTH		AVAILABLE
	inches	mm	inches	mm	
107219	6"	152.4	5"	127	1 On Request

## WHEEL TOOLS

### HUB AND BEARING SEPARATOR SET



14  
PIECES



- Applications in: GM, Ford, Honda, Mazda, Toyota, Nissan, Mitsubishi, Daihatsu, Subaru, Saab, VW, Fiat, Renault, and Hyundai.
- Facilitates the installation and release of hubs and hub bearings. Adapts to various wheel stud patterns based on vehicle model.



PLASTIC BOX

ITEM	PIECES	AVAILABLE
886	14	1 ✓

### BEARING REMOVAL AND INSTALLATION TOOL SET



13  
PIECES



- Facilitates the installation and removal of bearings.
- Fits most bearing races and seals.
- Phosphate finish.
- Durable plastic case for convenient storage.



ITEM	CAPACITY	AVAILABLE
887	2-3/16" to 3-3/16"	1 ✓

### BEARING REMOVER AND INSTALLER SET



10  
PIECES



- Facilitates the installation and removal of bearings.
- Fits most bearing races and seals.
- Satin finish.
- Durable plastic case for convenient storage.



PLASTIC BOX

ITEM	CAPACITY	AVAILABLE
2326	1,56" to 3,18"	1 ✓

### TRUCK WHEEL BEARING LOCKNUT SOCKET SET



7  
PIECES



- Prevents damage to the axle bearing locknut.



- Rounded hex nut (6R).



- Hex nut (6 point).

- Manufactured from 1008 steel with phosphate coating for corrosion protection.
- Design prevents damage to the locknut on axle bearings.
- Use with breaker bars, never with power tools.
- Plastic case for better storage.



ITEM	PIECES	AVAILABLE
P1900	7	1 ✓

### WHEEL BEARING LOCKNUT SOCKETS



- \* ROUND NUTS.
- \*\* HEX NUT.

- Manufactured from 1008 steel with phosphate coating for corrosion protection.
- Design prevents damage to the locknut on axle bearings.
- Use with breaker bars, never with power tools.



P1902



P1908



P1914

ITEM	OPENING SIZE	DIAMETER	LENGTH	AVAILABLE
P1902	2-3/8"	2-3/4"	3-1/2"	1 ✓
*P1904	2-9/16"	2-7/8"	3-1/2"	1 ✓
P1921	2-1/2"	2-7/8"	3-1/2"	1 ✓
**P1908	3-1/4"	3-5/8"	3-1/2"	1 ✓
P1910	3-1/2"	3-15/16"	3-1/2"	1 ✓
*P1914	4"	4-3/8"	3-1/2"	1 ✓

**WHEEL TOOLS**

**THIN-WALL DEEP WHEEL PROTECTIVE IMPACT SOCKETS**

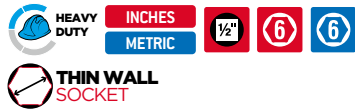

- Forged alloy steel for higher torque resistance.
- High-wear Nylamid sleeve with dimensional stability to prevent rim damage.
- Thin-wall profile for use on rims with reduced cavities.
- Different colors for quick, easy identification.



7317MP      7319MP      7321MP      7328P

INDIVIDUAL SOCKETS										SETS SOCKETS	
OPENING SIZE	ITEM	TYPE	COLOR	LENGTH	NUT END OUTSIDE DIAMETER	DRIVE END OUTSIDE DIAMETER	NUD DEPTH	⊕	AVAILABLE	ITEM	PIECES
17 mm	7317MP	II	Blue	3-11/16"	1-1/16"	1-5/32"	1"	1	✓	7300MP	3
19 mm (3/4")	7319MP	II	Yellow	3-11/16"	1-9/64"	1-1/4"	1"	1	✓		
21 mm (13/16")	7321MP	II	Red	3-11/16"	1-7/32"	1-7/32"	1"	1	✓		
22.2 mm 7/8"	7328P	II	Green	3-11/16"	1-17/64"	1-11/32"	1"	1	✓		

**1/2" DRIVE SOCKET WITH FIXED NYLAMID COVER**

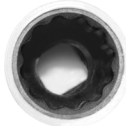

- Forged from alloy steel for higher torque resistance.
- High-wear Nylamid sleeve with dimensional stability to prevent damage to automotive rims.
- Thin-wall design for use on rims with narrow cavities.
- Phosphate finish provides corrosion resistance.

ITEM	OPENING SIZE	LENGTH	EXTERNAL DIAMETER	⊕	AVAILABLE
7321MPR	21 mm	3-17/64"	1-1/2"	1	✓

**3/4" DRIVE SOCKETS WITH NYLAMID FIXED COVER**

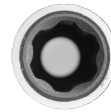

• Surface



- Forged from alloy steel for higher torque resistance.
- High-wear Nylamid sleeve with dimensional stability to prevent rim damage.
- Thin-wall design for tight-clearance rims.
- Phosphate finish for corrosion resistance.

ITEM	OPENING SIZE	LENGTH	EXTERNAL DIAMETER	⊕	AVAILABLE
7521MFP	21 mm	3-1/2"	1-1/2"	1	✓
7522MFP	22 mm	3-1/2"	1-1/2"	1	✓

**1/2" DOUBLE HEAD IMPACT SOCKET SET**

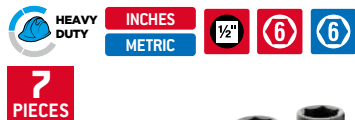

Content	
742426	Double head SAE socket 1/2" X 3/4" x 13/16"
741719M	Double head metric socket 1/2" x 17 mm x 19 mm
741921M	Double head metric socket 1/2" x 19 mm x 21 mm
742426T	Double head SAE long socket 1/2" X 3/4" x 13/16"
741921MT	Double head metric thin wall long socket 1/2" x 19 mm x 21 mm
7180P	1/2" x 2" impact socket extension bar
7181P	1/2" x 5" impact socket extension bar

- Phosphate finish for corrosion resistance.

ITEM	PIECES	⊕	AVAILABLE
7400DE	7	1	✓

**DOUBLE HEAD IMPACT SOCKETS**



742426

- Forged alloy steel for higher torque resistance.
- Phosphate coating for corrosion protection.

ITEM	OPENING SIZE (B1)	OPENING SIZE (C1)	LENGTH	⊕	AVAILABLE
742426	3/4"	13/16"	2-3/4"	1	✓
741719M	17 mm	19 mm	2-9/32"	1	✓
741921M	19 mm	21 mm	2-9/32"	1	✓

## WHEEL TOOLS

### METRIC AND SAE 6 POINTS 1/2" DRIVE SOCKETS



**THIN WALL SOCKET**



742426T

- Forged alloy steel for higher torque resistance.
- Phosphate finish provides corrosion resistance.

**BULK**

ITEM	OPENING SIZE (B1)	OPENING SIZE (C1)	LENGTH	☞	AVAILABLE
742426T	3/4"	13/16"	3"	1	✓
741921MT	19 mm	21 mm	3"	1	✓

**URREA**  
SUPERIOR QUALITY AFFORDABLE TOOLS



### SAE TRUCK WHEEL SOCKETS



07524LS

- Forged from alloy steel for greater torque resistance.
- Phosphate finish provides corrosion resistance.
- 13/16" inner square opening for caps.

**BULK**

ITEM	OPENING SIZE	SQUARE	LENGTH	☞	AVAILABLE
07524LS	1-1/2"	3/4"	3-9/16"	1	✓
10024LS	1-1/2"	1"	3-15/16"	1	✓

**URREA**  
SUPERIOR QUALITY AFFORDABLE TOOLS



### METRIC TRUCK WHEEL SOCKET



- Forged from alloy steel for greater torque resistance.
- Phosphate finish provides corrosion resistance.
- For Unemon nuts.

**BULK**

ITEM	OPENING SIZE	SQUARE	LENGTH	☞	AVAILABLE
10033ML	33 mm	1"	3-1/2"	1	✓

**URREA**  
SUPERIOR QUALITY AFFORDABLE TOOLS



### SAE 1" DRIVE SQUARE IMPACT SOCKET



- Forged from alloy steel for greater torque resistance.
- Phosphate finish provides corrosion resistance.
- Double square 1" x 13/16" x 2-3/8".
- Includes 13/16" square to loosen or tighten the cap used on dual wheels.

**BULK**

ITEM	OPENING SIZE	SQUARE	LENGTH	☞	AVAILABLE
10013DS	13/16"	1"	2-3/8"	1	✓

**SURTEK**  
TOOLS FOR SPECIALISTS



### 1-1/8" DAMAGED THREAD LUG NUT REMOVER



- Forged from alloy steel for greater torque resistance.
- Phosphate finish provides corrosion resistance.
- Cap extractor for trucks with damaged threads, useful in large truck tire shops and for tractor-trailers and trucks from 3 tons and up.

**BULK**

ITEM	EXTRACTOR SIZE	OUTER HEXAGON SIZE	LENGTH	☞	AVAILABLE
CD13	1-1/8"	1-1/2"	3"	1	✓

**URREA**  
SUPERIOR QUALITY AFFORDABLE TOOLS



### 1" DRIVE 6-POINT TRUCK WHEEL IMPACT SOCKETS



107279



107282

- Forged alloy steel for higher torque resistance.
- Phosphate finish provides corrosion resistance.

ITEM	SQUARE DRIVE	OPENING SIZE	TOTAL LENGTH	☞	AVAILABLE
107279	1"	1-3/16"	3-3/8"	1	On Request
107280	1"	1-1/4"	3-3/8"	1	On Request
107281	1"	33 mm	3-3/8"	1	On Request
107282	1"	1-1/2"	3-3/8"	1	On Request



**SURTEK**  
TOOLS FOR SPECIALISTS



**WHEEL TOOLS**

**1" DRIVE 6-POINT & 4-POINT TRUCK WHEEL IMPACT SOCKET**



INCHES



- Forged from alloy steel for increased torque resistance.
- Phosphate-coated finish provides enhanced corrosion protection.
- The internal drive profile of the socket allows removal or installation of the dust cap used in dual-wheel assemblies, while the hexagonal profile engages the lug nuts.



ITEM	SQUARE DRIVE	SQUARE OPENING	HEX OPENING	TOTAL LENGTH	AVAILABLE
107283	1"	13/16"	1-1/2"	3-13/16"	1 On Request

**DAMAGED THREAD LUG NUT REMOVER**



INCHES



- Forged from alloy steel for increased torque resistance.
- Phosphate-coated finish provides corrosion protection.
- Designed for trucks with a capacity of 3 tons and above.



ITEM	EXTRACTOR SIZE	OUTER HEX SIZE	AVAILABLE
107285	1-3/16"	1-1/2"	1 On Request

**1" DRIVE 4-POINT WHEEL TRUCK IMPACT SOCKET**



INCHES



- Forged from alloy steel for greater torque resistance.
- Phosphate finish provides corrosion resist.



ITEM	SQUARE DRIVE	OPENING SIZE	TOTAL LENGTH	AVAILABLE
107284	1"	13/16"	3-1/8"	1 On Request

**WHEEL WEIGHT PLIERS**



- Handle with plastisol coating.
- Wheel weight crimping tool.
- Tips designed to install or remove wheel weights without damaging any components.
- Installs, removes, trims, and secures all clip-type wheel weights.
- Features a special material on the hammer head to protect the wheel and rim from damage; specially designed for alloy and sport wheels.



ITEM	DESCRIPTION	AVAILABLE
25K	Middle point hook opening 9-1/4"	1 On Request

**SCREWDRIVER VALVE STEM CORE REMOVER**

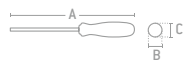

107267  
Corto



107264  
Largo

- For installing and removing standard valve cores.

ITEM	TOTAL LENGTH (A)	WIDTH (B)	HEIGHT (C)	AVAILABLE
107267	3-3/8"	5/8"	9/16"	6 ✓

**MOTORCYCLE TIRE WRENCH**



107264

ITEM	TOTAL LENGTH (A)	WIDTH (B)	HEIGHT (C)	AVAILABLE
107264	4-17/32"	15/32"	15/32"	6 ✓

**TIRE VALVE REPAIR TOOL**



- 4-in-1 tool.
- Installs and removes valve cores.
- Extracts damaged valve cores.
- Reconditions internal and external threads of the valve.



ITEM	LENGHT	WIDHT	HEIGHT	AVAILABLE
107268	3.7"	5.5"	0.7"	1 On Request

**MOTORCYCLE TIRE WRENCH**



- Forged from alloy steel for greater torque resistance.
- Phosphate finish provides corrosion resist.

**BULK**

ITEM	SIZE	AVAILABLE
BDL12	12"	1 ✓

## WHEEL TOOLS

### TIRE IRON



- Forged from alloy steel for greater torque resistance.
- Phosphate finish provides corrosion resistance.

**BULK**

ITEM	SIZE	☞	AVAILABLE
CE1	26" x 11/16"	1	✓

### SPOON TIRE IRONS



- Forged from alloy steel for greater torque resistance.
- Phosphate finish provides corrosion resistance.

**BULK**

ITEM	SIZE	☞	AVAILABLE
CE2	25" x 11/16"	1	✓
CE3	30" x 11/16"	1	✓

### DIAL TYPE TIRE GAUGE



- Manufactured from stainless steel with plastic cover for greater corrosion protection.
- Dial graduated in PSI.
- Reading lock function.



ITEM	MAXIMUM PRESSURE	☞	AVAILABLE
107269	60 psi	12	On Request

### DOUBLE HEAD TIRE GAUGE



107274



107270

- Plastic gauge graduated in PSI.
- Manufactured from stainless steel with mirror-polished finish for greater corrosion resistance.

ITEM	MAXIMUM PRESSURE	TOTAL LENGTH	☞	AVAILABLE
107274	120 psi	15"	6	✓
107270	120 psi	8"	6	On Request

## OIL FILTER & ACCESSORIES TOOLS

### DRAIN PLUG SOCKET SET



**14**  
PIECES

#### Content

- 9, 10, 12, 14 & 17 mm
- 7, 8, 11, 13 mm & 5/16", 3/8"
- 10 mm
- ▲ 10 mm
- M16

- Applicable to most automotive brands such as: BMW®, Renault®, Mazda®, Fiat®, Mercedes®, Toyota®, Ford®, Nissan®, GM®, Honda®, Peugeot®, Volkswagen®.

ITEM	PIECES	☞	AVAILABLE
2393	14	1	✓

### ADJUSTABLE PLIERS FOR FILTER REMOVAL



**NEW**

- Removes and installs tight and heavy-duty oil filters.

ITEM	MINIMUM CAPACITY	MAXIMUM CAPACITY	☞	AVAILABLE
PAF3	2-3/8"	3-1/7"	1	On Request
PAF7	2-7/8"	7"	1	On Request

### OIL FILTER LOCKING PLIER



- Deep teeth reduce the risk of slipping.
- Body and handle made of cold-rolled quality steel with knurled-head adjusting screw and lock nut.
- Forged jaws with teeth machined using special cutting tools.
- Epoxy paint finish, 10 times more resistant to corrosion than nickel.

ITEM	MINIMUM CAPACITY	MAXIMUM CAPACITY	☞	AVAILABLE
4122	2-1/8"	3-1/4"	1	✓

### OIL FILTER WRENCH SET



**3**  
PIECES

#### Content

- Oil filter wrench by 4 cylinder engine 1
- Oil filter wrench by 6-8 cylinder engine 1
- Cam clamp singles 1



- Made of high-strength aluminum alloy. Compatible with all types of Toyota® oil filters.
- Provides multiple contact points that allow safe and easy removal of the filter cover.
- Hose assembly allows oil to be drained from the housing before removal.
- Eliminates oil spills and enables quick and easy cleaning.

ITEM	DESCRIPTION	☞	AVAILABLE
LF2500	For 4,6 and 8 cylinders	1	On Request

**OIL FILTER & ACCESSORIES TOOLS**

**OIL FILTER WRENCHES**



- Manufactured from carbon steel.
- 3/8" drive input for ratchet.



ITEM	MINIMUM CAPACITY	MAXIMUM CAPACITY	☐	AVAILABLE
107319	2-7/16"	4-3/4"	1	On Request

**OIL FILTER WRENCHES**



- Manufactured from carbon steel.
- 3/8" Drive input for ratchet.
- Arms with plastic coating for superior filter grip.



ITEM	MINIMUM CAPACITY	MAXIMUM CAPACITY	☐	AVAILABLE
107314	2-1/2"	3-7/8"	1	On Request

**ADJUSTABLE OIL FILTER WRENCH**



LF5000

- Manufactured from alloy steel.
- 3/8" drive input for ratchet.
- Curved arm for better filter engagement.



ITEM	MINIMUM CAPACITY	MAXIMUM CAPACITY	☐	AVAILABLE
LF5000	2-1/2"	3-1/8"	1	On Request
LF6000	3-1/8"	3-7/8"	1	On Request

**TRUCK OIL FILTER WRENCH**



- Manufactured from alloy steel.
- 1/2" drive input for ratchet.
- Ideal for truck filter applications.



ITEM	MINIMUM CAPACITY	MAXIMUM CAPACITY	☐	AVAILABLE
LF2000	4-3/8"	5-5/8"	1	✓

**UNIVERSAL SWIVEL OIL FILTER WRENCH**



LF500

- Manufactured from alloy steel.
- Handle coated with plastisol for firm and comfortable grip.



ITEM	MINIMUM CAPACITY	MAXIMUM CAPACITY	☐	AVAILABLE
LF500	2-3/4"	3-1/8"	1	✓
LF1000	3-1/2"	3-3/4"	1	✓

**OIL FILTER WRENCHES**



10

- Manufactured from stainless steel.
- Plastic handle for greater comfort.



ITEM	MINIMUM CAPACITY	MAXIMUM CAPACITY	☐	AVAILABLE
5	2-3/4"	3-1/4"	1	On Request
10	3-7/16"	3-3/4"	1	On Request

**STRAP OIL FILTER WRENCH**



- Provides quick adjustment to the oil filter size and facilitates replacement.
- High-strength nylon canvas band.
- Frame made of heavy-gauge alloy steel.



ITEM	MINIMUM CAPACITY	MAXIMUM CAPACITY	☐	AVAILABLE
LF1500	0"	6"	1	✓

**OIL FILTER WRENCHES**



- Provides quick adjustment to the oil filter size and facilitates replacement.
- High-strength nylon canvas band.



ITEM	MINIMUM CAPACITY	MAXIMUM CAPACITY	☐	AVAILABLE
107315	0"	6"	1	On Request

**WASTE OIL DRAIN WITH SUCTION**



- Multi-use tray
- Protective grid
- Level indicator

**17 GAL**  
TANK CAPACITY

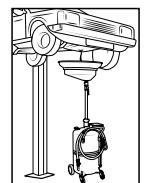
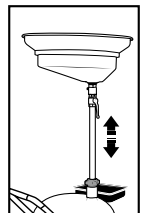

- For draining engine oil, gearbox oil, differential oil, transmission oil, etc., by pneumatic suction (requires air compressor) or by gravity, from all types of vehicles placed on an automatic lift or pit.
- Side oil level gauge on the storage tank.
- Protective grid prevents foreign objects from falling into the tank.
- Multi-purpose tray.



ITEM	TANK CAPACITY	COLLECTING FUNNEL CAPACITY	DRAIN HOSE LENGTH	ADJUSTABLE HEIGHT MAXIMUM	ADJUSTABLE HEIGHT MINIMUM	OIL SUCTION SPEED	MAXIMUM DRAINAGE PRESSURE	☐	AVAILABLE
23973	17 gal	4 gal	6.6'	68-7/64"	44-1/2"	1.5-2 L/min	4-7 bar	1	On Request

## OIL FILTER & ACCESSORIES TOOLS

### WASTE OIL DRAIN BY GRAVITY

- HEAVY DUTY
- Multi-use tray
- Protective grid
- Lever indicator

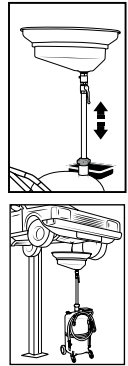

- For draining engine oil, gearbox oil, differential oil, transmission oil, etc., by gravity, from all types of vehicles placed on an automatic lift or pit.
- Side oil level gauge on the storage tank.
- Protective grid prevents foreign objects from falling into the tank.
- Multi-purpose tray.

23971

23972

ITEM	TANK CAPACITY	COLLECTING FUNNEL CAPACITY	DRAIN HOSE LENGTH	ADJUSTABLE HEIGHT		⊞	AVAILABLE
				MAXIMUM	MINIMUM		
23971	17 gal	4 gal	6,6"	66,5"	43-23/32"	1	On Request
23972	23 gal	4 gal	6,6"	70,9"	48"	1	On Request

AUTOMOTIVE AND HYDRAULIC TOOLS

### WASTE OIL DRAIN FOR TRUCK

- HEAVY DUTY
- STEEL
- 4 SWIVEL CASTERS
- 17 GAL TANK CAPACITY



- Easy-draining nozzle
- Gravity draining
- Protective grid

- For draining engine oil, gearbox oil, differential oil, transmission oil, etc., from trucks.
- Manufactured from steel.
- Equipped with 4 wheels.
- Gravity drain system.
- Includes steel mesh filter.
- Eliminates the need to lift heavy vehicles.



ITEM	LENGTH	HEIGHT	WIDTH	⊞	AVAILABLE
23975	32.28"	10.24"	24.41"	1	On Request

### PLASTIC OIL DRAIN

- INDUSTRIAL DUTY



- Manufactured from high-density polyethylene.
- Recommended for use with oils and antifreeze.
- Anti-splash edge.
- Long spout for easy and quick draining.
- Resistant to chemicals and solvents.
- Spill-proof cap.



**BULK**

ITEM	CAPACITY	SIZE	⊞	AVAILABLE
2397	4.2 gal	23.23" x 18.43" x 5.79"	1	On Request

## ENGINE TOOLS & ACCESSORIES

### OXYGEN AND OIL SENSOR SOCKET SET

- INDUSTRIAL DUTY



**7**  
PIECES



Content	
Drive	Description
1	1-1/16" and 1" oil pressure sensor unit socket.
2	7/8" vacuum switch and O2 socket (wide slot).
3	7/8" vacuum switch and O2 socket (narrow slot).
4	27 mm terminal sensor switch.
5	29 mm vacuum switch and O2 socket.
6	O2 sensor socket (low profile), offset 3/8" drive.
7	7/8" O2 sensor socket, Offset 1/2" drive.

ITEM	DESCRIPTION	⊞	AVAILABLE
2330S	Oxygen and oil in plastic case	1	✓



**ENGINE TOOLS & ACCESSORIES**

**OXYGEN SENSOR SOCKET, 3/8" DRIVE**



INCHES

3/8"



**URREA**



- Forged from alloy steel for greater torque resistance.
- Mirror-polished finish provides greater corrosion resistance.
- Used on Ford®, General Motors®, Chrysler®, and some imported vehicles.

ITEM	OPENING SIZE	DIAMETER	LENGTH	⊞	AVAILABLE
5030S	7/8"	1-15/64"	63/64"	1	✓

**OIL PRESSURE SWITCH SOCKET, 3/8" DRIVE**



INCHES

3/8"

**ZINC PHOSPHATE FINISH**



**URREA**



- Forged from alloy steel for greater torque resistance.
- Phosphate finish provides corrosion resistance.
- For all 1" and 1-1/16" hex sending units and lengths up to 2-5/8".

ITEM	DRIVE	OPENING 1	OPENING 2	⊞	AVAILABLE
5030A	3/8"	1"	1-1/16"	1	✓

**OXYGEN SENSOR SOCKET, 3/8" DRIVE**



INCHES

3/8"



**SURTEK**



- Forged from alloy steel for greater torque resistance.
- Satin finish for corrosion resistance.
- Used on Ford®, General Motors®, Chrysler®, and some imported vehicles.

ITEM	OPENING SIZE	⊞	AVAILABLE
BF5130S	7/8"	1	On Request

**OIL PRESSURE SWITCH SOCKET, 1/2" DRIVE**



INCHES

1/2"



**SURTEK**



- Forged from alloy steel for greater torque resistance.
- Satin finish for corrosion resistance.
- For all 1" and 1-1/16" hex sending units and lengths up to 2-5/8"

ITEM	DRIVE	OPENING 1	OPENING 2	⊞	AVAILABLE
BF583234	1/2"	1"	1-1/16"	1	On Request

**SUPER DUTY FUEL LINE DISCONNECT TOOL SETS**



12  
PIECES



2210

Color	Size
Black	1/4"
Red	5/16"
Golden yellow	3/8"
Blue	3/8"

- For GM® transmission oil cooling line.
- For Ford® clutch line.
- For cooling line.
- For transmission oil.
- For fuel line.

**PLASTIC BOX**

ITEM	PIECES	⊞	AVAILABLE
2210	12	1	✓



7  
PIECES

Size
1/4"
5/16"
3/8"
1/2"
5/8"
3/4"
7/8"



2344

- Ideal for making quick couplings on automotive hoses and for firmly disconnecting air conditioning lines and fuel lines.
- Quick-connect and release system.

ITEM	PIECES	⊞	AVAILABLE
2344	7	1	✓

**URREA**



**DISCONNECT TOOL SET LINE**



7  
PIECES

Size
1/4"
5/16"
7/8"
3/4"
5/8"
1/2"
3/8"



- Ideal for making quick couplings on automotive hoses and for firmly disconnecting air conditioning lines and fuel lines.

ITEM	PIECES	⊞	AVAILABLE
107346	7	1	On Request

**SURTEK**



**FUEL LINE DISCONNECT TOOL AND A/C**



**SURTEK**



- Manufactured from zamak with chrome finish for corrosion protection.
- Useful for spring couplings in air conditioning systems, radiator, and transmission lines

ITEM	MOTORS	⊞	AVAILABLE
107272	Ford® (81 ahead) Chrysler® (Series LH)	1	On Request

**FUEL LINE DISCONNECT TOOLS**



**SURTEK**



- Manufactured from zamak with chrome finish for corrosion protection.
- Opens spring locks on fuel lines in fuel injection systems.

ITEM	MOTORS	⊞	AVAILABLE
107271	GM®, Ford®, Chrysler®	1	On Request

AUTOMOTIVE AND HYDRAULIC TOOLS

## ENGINE TOOLS & ACCESSORIES

### CAMSHAFT SEAL AND CRANKSHAFT INSTALLER AND REMOVAL SET



**24**  
PIECES

Content	
Installer sleeves	4
Mandrels	7
Metallic punches	8
Puller Jaws	4
Mini-puller with 2 arm pairs	1



VIDEO

- Multiple mandrels for installation.
- Compatible with seals from 21.5 mm to 64 mm.
- For easy removal and installation of camshaft and crankshaft seals.
- Includes compact puller with hooks for quick extraction.
- Interchangeable sleeves and mandrels allow installation of the new seal.

PLASTIC BOX

ITEM	PIECES	AVAILABILITY
2380	24	1 ✓

### UNIVERSAL PULLEY HOLDER



**11**  
PIECES



PLASTIC BOX

- Manufactured from steel with plastic-coated handle.
- Includes 4 different interchangeable pins.
- Ideal for loosening or tightening any pulley with slots or holes.
- Facilitates maintenance and repair of automotive equipment.

ITEM	OPENING	AVAILABILITY
2308	1-1/2" - 8-5/8"	1 On Request

### TWIN CAMSHAFT LOCKING KIT



**19**  
PIECES



PLASTIC BOX

- Includes the most common camshaft locks and pins for Ford®, Land Rover®, Fiat®, Peugeot®, Volkswagen®, Honda®, and Opel® engines.
- Allows replacement of the timing chain in dual overhead camshaft (multi-valve) engines, ensuring correct valve timing.

ITEM	PIECES	AVAILABILITY
2358	19	1 On Request

### CRANKSHAFT DAMPER HOLDER



- Tool for easily loosening/tightening the crankshaft pulley bolt.
- Special design allows easy access to the crankshaft pulley.
- Applicable to most Honda® and Acura® engines.
- Includes 1/2" square drive to attach an accessory and generate more torque.



ITEM	MOTORS	AVAILABILITY
2388	Honda® - Acura®	1 ✓

### SERPENTINE BELT TOOL



**8**  
PIECES

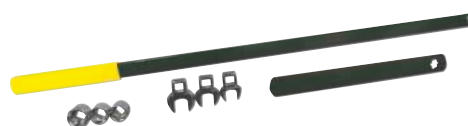

Content	
23" x 3/8" long flat bar	1
9" x 1/2" short flat bar	1
3/8" Hex square sockets (15 mm, 16 mm, 18 mm)	3
3/8" Crowfoot wrenches (13 mm, 14 mm, 15 mm)	3

- For installing the belt onto the pulley system using the spring-tensioned pulley.
- Used when a conventional wrench or ratchet cannot access.

ITEM	PIECES	AVAILABILITY
107259	8	1 On Request

### CAMSHAFT LOCKING KIT



**6**  
PIECES



- Includes the most common camshaft locks and pins for Volkswagen®, Seat®, and Audi® engines.
- Allows replacement of the timing chain or belt, ensuring correct valve timing.

ITEM	PIECES	AVAILABILITY
2359	6	1 ✓

### MICRO-ADJUSTABLE CYLINDER POLISHER



**4**  
PIECES



2390

- For use in cylinders of different diameters thanks to its expanding head.
- Screw allows adjustment of the pressure of the abrasive stones against the cylinder walls.
- Abrasive stones: coarse / 80 grit and fine / 180 grit.

PLASTIC BOX

ITEM	PIECES	MINIMUM OPENING	MAXIMUM OPENING	AVAILABILITY
2390	4	3"	5"	1 On Request



2390A

- Smooth finish.
- Length 5" and 4".
- Replacement stone for honer 2390.

#### Polishing stone pads for polisher 2390

ITEM	POLISH	AVAILABILITY
2390A	Soft	1 ✓
2390B	Fine	1 ✓

**ENGINE TOOLS & ACCESSORIES**

**ENGINE CYLINDER HONE**



2391

- Flexible shaft with tension adjustment.
- Body design protects the stone during use and eases insertion into cylinders.
- Removes all impurities from the internal parts of automotive cylinders.
- Collar design prevents the stone from breaking.



2391A

- Replacement stones for hone 2391.
- 3 pieces.
- Length 3".



ITEM	MINIMUM OPENING		MAXIMUM OPENING		☞	AVAILABLE
	inches	mm	inches	mm		
2391	2"	50.8	7"	177	1	✓

**Replacement stone pads for polisher 2391**

ITEM	LENGTH	GRIT	☞	AVAILABLE
2391A	3"	Extra fine	1	✓

**ENGINE CYLINDER HONE**



107227

- Flexible shaft with tension adjustment.
- Body design protects the stone during use and eases insertion into cylinders.
- Removes all impurities from the internal parts of automotive cylinders.



107228



ITEM	MINIMUM OPENING		MAXIMUM OPENING		☞	AVAILABLE
	inches	mm	inches	mm		
107227	2"	51	7"	178	1	On Request

**Repuestos**

ITEM	GRIT TYPE	☞	AVAILABLE
107228	Fine	1	On Request
107229	Medium	1	On Request
107230	Coarse	1	On Request

**BLADE FEELER GAUGE SET WITH 45° TIPS**



**26**  
BLADES



Sizes in.	Sizes in.	Sizes in.	Sizes in.	Sizes in.	Sizes in.	Sizes in.
0.005	0.025	0.021	0.017	0.013	0.009	0.029
0.01	0.006	0.026	0.022	0.018	0.014	0.03
0.015	0.011	0.007	0.027	0.023	0.019	
0.02	0.016	0.012	0.008	0.028	0.024	

- Manufactured from stainless steel for greater durability and corrosion resistance.

ITEM	002645
BLADES	26
DESCRIPTION	45° tips
BLADE SIZES	0.005" to 0.03"
☞	1
AVAILABLE	✓

**EXTRA LONG BLADE FEELER GAUGE SET**



**25**  
BLADES

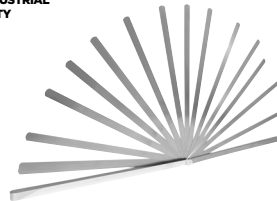

Sizes in.	Sizes in.	Sizes in.	Sizes in.	Sizes in.	Sizes in.	Sizes in.
0.0015	0.005	0.009	0.013	0.017	0.021	0.040
0.002	0.006	0.010	0.014	0.018	0.025	
0.003	0.007	0.011	0.015	0.019	0.027	
0.004	0.008	0.012	0.016	0.020	0.030	

- Manufactured from stainless steel for greater durability and corrosion resistance.

ITEM	000F
BLADES	25
DESCRIPTION	Extra Long 12"
BLADE SIZES	0.0015" to 0.040"
☞	1
AVAILABLE	✓

**SAE BLADE FEELER GAUGE SET**



**25**  
BLADES



Sizes in.	Sizes in.	Sizes in.	Sizes in.	Sizes in.	Sizes in.	Sizes in.
0.0015	0.005	0.009	0.013	0.017	0.025	0.040
0.002	0.006	0.01	0.014	0.018	0.030	
0.003	0.007	0.011	0.015	0.020	0.032	
0.004	0.008	0.012	0.016	0.022	0.035	

- Manufactured from stainless steel for greater durability and corrosion resistance.

ITEM	000AA
BLADES	25
DESCRIPTION	SAE
BLADE SIZES	0.0015" to 0.040"
☞	1
AVAILABLE	✓

**METRIC 25-BLADE FEELER GAUGE SET**



**25**  
BLADES



Sizes mm	Sizes mm	Sizes mm	Sizes mm	Sizes mm	Sizes mm	Sizes mm
0.04	0.05	0.06	0.07	0.08	0.09	1.00
0.10	0.15	0.20	0.25	0.30	0.35	
0.40	0.45	0.50	0.55	0.60	0.65	
0.70	0.75	0.80	0.85	0.90	0.95	

- Manufactured from stainless steel for greater durability and corrosion resistance.

ITEM	000M25
BLADES	25
DESCRIPTION	Metric
BLADE SIZES	0.04 to 1.00 mm
☞	1
AVAILABLE	✓

**IGNITION BLADE FEELER GAUGE SET**



**23**  
BLADES

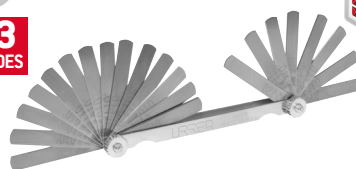

Sizes in.	Sizes in.	Sizes in.	Sizes in.	Sizes in.	Sizes in.
0.008	0.013	0.017	0.021	0.025	0.032
0.010	0.014	0.018	0.022	0.026	0.035
0.011	0.015	0.019	0.023	0.028	0.040
0.012	0.016	0.020	0.024	0.030	

- Manufactured from stainless steel for greater durability and corrosion resistance.

ITEM	000D
BLADES	23
DESCRIPTION	Ignition blade
BLADE SIZES	0.008" to 0.040"
☞	1
AVAILABLE	✓

**GO-NO-GO BLADE FEELER GAUGE SET**



**22**  
BLADES



Sizes in.	Sizes in.	Sizes in.	Sizes in.	Sizes in.	Sizes in.
0.004 - 0.006	0.008 - 0.010	0.012 - 0.014	0.016 - 0.018	0.020 - 0.022	0.024 - 0.026
0.005 - 0.007	0.009 - 0.011	0.013 - 0.015	0.017 - 0.019	0.021 - 0.023	0.025 - 0.027
0.006 - 0.008	0.010 - 0.012	0.014 - 0.016	0.018 - 0.020	0.022 - 0.024	
0.007 - 0.009	0.011 - 0.013	0.015 - 0.017	0.019 - 0.021	0.023 - 0.025	

- Manufactured from stainless steel for greater durability and corrosion resistance.

ITEM	000N
BLADES	22
DESCRIPTION	Go-no-go
BLADE SIZES	0.004" - 0.006" to 0.025" - 0.027"
☞	1
AVAILABLE	✓

AUTOMOTIVE AND HYDRAULIC TOOLS

## ENGINE TOOLS & ACCESSORIES

### EXTRA LONG BLADE FEELER GAUGE SET



**9**  
BLADES



Sizes in.	Sizes in.	Sizes in.
0.003	0.006	0.012
0.004	0.008	0.015
0.005	0.010	0.018

- Manufactured from stainless steel for greater durability and corrosion resistance.

ITEM	000A
BLADES	9
DESCRIPTION	SAE
BLADE SIZES	0.003" to 0.018"
☞	1
AVAILABLE	✓

### SPARK PLUG GAP GAUGE



**Sizes in.**  
0.020 to 0.100



- Manufactured from stainless steel for greater durability and corrosion resistance.
- Ideal tool for spark plug gapping and calibration.
- Adjusts and sets gap sequence in inches.

ITEM	000LL
DESCRIPTION	Spark plug gap gauge
☞	1
AVAILABLE	✓

### BLADE FEELER GAUGE SET WITH 45° TIPS



**12**  
BLADES



Sizes in.	Sizes in.	Sizes in.	Sizes in.	Sizes in.	Sizes in.
0.008"	0.012"	0.014"	0.016"	0.019"	0.025"
0.010"	0.013"	0.015"	0.018"	0.020"	0.026"

- Manufactured from hardened steel for superior durability.
- Blades pre-bent at the proper angle for engine valve adjustment.

ITEM	107323
BLADES	12
BLADE SAE SIZES	0.008" to 0.026"
BLADE MM SIZES	0.20 to 0.660
☞	6
AVAILABLE	On Request

### SAE AND METRIC BLADE FEELER GAUGE SET



**32**  
BLADES

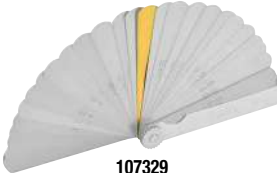

107329

Sizes in.	Sizes in.	Sizes in.	Sizes in.	Sizes in.	Sizes in.	Sizes in.	Sizes in.
0.0015"	0.005"	0.010"	0.014"	0.019"	0.024"	0.032"	0.035"
0.002"	0.006"	0.010" copper blade	0.015"	0.020"	0.025"	0.032"	0.035"
0.0025"	0.007"	0.011"	0.016"	0.021"	0.026"	0.032"	0.035"
0.003"	0.008"	0.012"	0.017"	0.022"	0.028"	0.032"	0.035"
0.004"	0.009"	0.013"	0.018"	0.023"	0.030"	0.032"	0.035"

- Manufactured from hardened steel for greater durability.

ITEM	107329	107331	107325
BLADES	32	26	15
BLADE SAE SIZES	0.015" to 0.035"	0.015" to 0.025"	0.002" to 0.025"
BLADE MM SIZES	0.038 to 0.889 mm	0.04 to 0.635 mm	0.051 to 0.635 mm
☞	6	6	6
AVAILABLE	On Request	On Request	On Request

### SAE AND METRIC BLADE FEELER GAUGE SET



**25**  
BLADES



107332

107327

107327

Sizes in.	Sizes in.	Sizes in.	Sizes in.	Sizes mm	Sizes mm	Sizes mm	Sizes mm
0.0015"	0.008"	0.0015"	0.0025"	0.04	0.15	0.50	0.85
0.002"	0.009"	0.0016"	0.0028"	0.05	0.20	0.55	0.90
0.003"	0.010"	0.0017"	0.0030"	0.06	0.25	0.60	0.95
0.004"	0.011"	0.0018"	0.0035"	0.07	0.30	0.65	1.00
0.005"	0.012"	0.0019"		0.08	0.35	0.70	
0.006"	0.013"	0.0020"		0.09	0.40	0.75	
0.007"	0.014"	0.0022"		0.10	0.45	0.80	

- Manufactured from hardened steel for superior durability.

ITEM	107332	107327
BLADES	9	25
DESCRIPTION	SAE	Metric
BLADE SIZES	0.003" to 0.018"	0.04 mm to 1.00 mm
☞	6	6
AVAILABLE	On Request	On Request

### GO-NO-GO BLADE FEELER GAUGE SET



**22**  
BLADES



Sizes in.	Sizes in.	Sizes in.	Sizes in.	Sizes in.
0.004" - 0.006"	0.009" - 0.011"	0.015" - 0.017"	0.020" - 0.022"	0.025" - 0.028"
0.005" - 0.007"	0.010" - 0.012"	0.016" - 0.018"	0.021" - 0.023"	
0.006" - 0.008"	0.011" - 0.013"	0.017" - 0.019"	0.022" - 0.024"	
0.007" - 0.009"	0.012" - 0.014"	0.018" - 0.020"	0.023" - 0.025"	
0.008" - 0.010"	0.013" - 0.015"	0.019" - 0.021"	0.024" - 0.026"	

- Manufactured from hardened steel for superior durability.

ITEM	107326
BLADES	22
BLADE SAE SIZES	0.004" to 0.028"
BLADE MM SIZES	0.102 mm to 0.686 mm
☞	6
AVAILABLE	On Request

### SPARK PLUG RAMPED GAP GAUGE



**22**  
BLADES



Sizes	Inches	Millimeters
0.020" to 0.10"		
0.5 to 2.5 mm		

- Manufactured from hardened steel for greater durability.
- Ideal tool for spark plug gapping and calibration.
- Adjusts and sets gap sequence in inches.

ITEM	107336
DESCRIPTION	Tipo rampa para bujía
☞	6
AVAILABLE	On Request

**ENGINE TOOLS & ACCESSORIES**

**1/2" DRIVE SPARK PLUG SOCKETS WITH NEOPRENE**



**INCHES** **1/2"** **6**



**532050**



**5326HPA**

- Forged from alloy steel for superior torque resistance.
- Mirror-polished finish provides excellent corrosion resistance.
- Neoprene insert securely holds the spark plug and facilitates removal.
- Ideal for use in automotive application.



ITEM	OPENING SIZE	DIAMETER	LENGTH	⊞	AVAILABLE
<b>532050</b>	5/8"	27/32"	2-1/2"	1	✓
<b>5326HPA</b>	13/16"	1-3/32"	2-17/32"	1	✓

**3/8" DRIVE SPARK PLUG SOCKETS WITH NEOPRENE**



**INCHES** **3/8"** **6**



**502050**



**5026HPA**

- Forged from steel for greater torque resistance.
- Mirror-polished finish provides greater corrosion resistance.
- Neoprene insert holds the spark plug and facilitates removal.
- Ideal for applications in the automotive industry.



ITEM	OPENING SIZE	DIAMETER	LENGTH	⊞	AVAILABLE
<b>502050</b>	5/8"	7/8"	2-1/2"	1	✓
<b>5026HPA</b>	13/16"	1-1/16"	2-17/32"	1	✓

**SPARK PLUG BOOT PLIERS**



- Spring-loaded design.
- Tips designed at 45°.
- Tips and handles covered with vinyl to prevent electrical shock, ensuring a better grip



ITEM	TOTAL LENGTH		MIN CLAMPING		⊞	AVAILABLE
	inches	mm	inches	mm		
<b>235</b>	9-3/4"	248	3/4"	19	1	✓

**THREAD CHASER**



- Ideal for cleaning scale, carbon deposits, and rethreading spark plug threads.
- Uses 13/16" deep socket.
- Double-ended for 14 mm and 18 mm threads.



ITEM	THREAD SIZE	⊞	AVAILABLE
<b>107239</b>	M18 x 1.25 mm	1	On Request

**1/2" DRIVE SPARK PLUG SOCKETS WITH NEOPRENE**



**INCHES** **1/2"** **6**



**F5826HPA**

- Forged from steel for superior torque resistance.
- Mirror-polished finish provides excellent corrosion resistance.
- Neoprene insert securely holds the spark plug and facilitates removal.
- Ideal for use in automotive application.



ITEM	OPENING SIZE	DIAMETER	LENGTH	⊞	AVAILABLE
<b>F582050</b>	5/8"	27/32"	2-1/2"	6	✓
<b>F5826HPA</b>	13/16"	1-3/32"	2-17/32"	6	✓

**3/8" DRIVE SPARK PLUG SOCKETS WITH NEOPRENE**



**INCHES** **3/8"** **6**



**F512050**

- Forged from steel for greater torque resistance.
- Mirror-polished finish provides greater corrosion resistance.
- Neoprene insert holds the spark plug and facilitates removal.
- Ideal for applications in the automotive industry.



ITEM	OPENING SIZE	DIAMETER	LENGTH	⊞	AVAILABLE
<b>F512050</b>	5/8"	27/32"	2-1/2"	6	✓
<b>F5126HPA</b>	13/16"	1-3/32"	2-17/32"	6	✓

**CYLINDER HEAD RETHREADER SET**



**5**  
**PIECES**



- Permanently repairs spark plug threads.
- Eliminates the need to completely replace the cylinder head.
- No drilling or machining required.
- Inserts are self-tapping into the hole and never come out.



ITEM	THREAD SIZE	⊞	AVAILABLE
<b>107238</b>	M14 x 1.25 mm	1	On Request

**SPARK PLUG SOCKET**



- Phosphate finish provides corrosion resistance.



ITEM	OPENING SIZE	TOTAL LENGTH	⊞	AVAILABLE
<b>30P</b>	5/8"	4"	12	✓
<b>40P</b>	13/16"	3-3/4"	12	On Request

## ENGINE TOOLS & ACCESSORIES

### ENGINE TIMING TOOL SET



**5**  
PIECES

Content	
Dual clamp	1
Cam clamp, singles	4



- Manufactured from anti-corrosive materials. The individual fasteners secure the gears independently.
- Ideal for changing the pump belt in diesel injection engines.
- Easy to use and quick installation.
- Includes four individual and adjustable fasteners.
- Locks the timing valve for belt replacement in single, double, or quadruple camshaft engines.

ITEM	PIECES	AVAILABILITY
2329	5	On Request



### CARBURETOR ADJUSTING TOOL



**5**  
PIECES



- Carburetor Adjustment Cable, 15-3/8" Flexible, Includes 4 Tips
- Great flexibility for adjusting jets in carbureted cars with difficult access, position the flexible tip on the screw or jet and turn the screwdriver.

ITEM	LENGTH		ADAPTERS	AVAILABILITY
	inches	mm		
2343	15-13/32"	390	4	✓

### VALVE SPRING COMPRESSOR TYPE C



- Valve spring compressor manufactured from steel.
- Wide throat capacity allows clamping of large engine cylinders.

ITEM	MAXIMUM OPENING	THROAT DEPTH		AVAILABILITY
		inches	mm	
2321	1-5/8" in "C"	9-5/8"	244	✓



### VALVES SPRING COMPRESSOR



- Valve spring compressor manufactured from steel.
- Plastic-coated handle.
- Wide throat capacity allows clamping of large engine cylinders.
- Retractable system provides greater visibility of the valves and access to tight spaces.

ITEM	OPENING	THROAT DEPTH		AVAILABILITY
		inches	mm	
2307	1-3/8" to 5-5/8"	5-7/8"	149.2	✓

AUTOMOTIVE AND HYDRAULIC TOOLS

### VALVE SPRING COMPRESSORS



107224



107225

- Valve spring compressor manufactured from steel.
- Plastic-coated handle.

ITEM	MINIMUM OPENING		MAXIMUM OPENING		THROAT CLEARANCE		AVAILABILITY
	inches	mm	inches	mm	inches	mm	
107224	2-5/32"	55	6-7/8"	175	6-1/2"	165	On Request
107225	1-3/8"	35	7-7/8"	200	9-7/8"	250	On Request



### UNIVERSAL VALVE SPRING COMPRESSOR



- Jaws forged from steel for greater strength.
- Blued finish provides corrosion resistance.

ITEM	MAXIMUM OPENING		JAW LENGTH		THROAT DEPTH		AVAILABILITY
	inches	mm	inches	mm	inches	mm	
107378	4"	102	4-1/4"	108	2-1/8"	54	On Request

### SPRING COMPRESSOR VALVE



- Cam-operated mechanism, no readjustment required after the first setting.
- Equipped with hex screw that replaces the handle for applications in hard-to-reach areas.

ITEM	MINIMUM OPENING		MAXIMUM OPENING		AVAILABILITY
	inches	mm	inches	mm	
2322	7/8"	22	2-1/4"	57	✓



### POWER STEERING, ALTERNATOR AND PULLEY REMOVER / INSTALLER KIT



**11**  
PIECES



- Easily removes power transmission components.
- Place the bar and installation nuts over the pulley, adjust according to the center screw, and remove by turning against the bar with a box-end wrench.

ITEM	PIECES	AVAILABILITY
980	11	✓

**ENGINE TOOLS & ACCESSORIES**

**POWER STEERING PULLEY PULLER AND INSTALLER KIT**

PROFESSIONAL USE

**6** PIECES



SURTEK



Contenido	
Forcing screw 5/8" - 18NF x 2,5" long	1
Forcing screw 5/8" - 18NF x 4" long	1
Forcing screw 3/8" - 16NC x 4" long	1
Forcing screw with two threads 3/8" - 16NC tip M8 x 1,25 x 18 mm long	1
Steel Sleeve 46 mm interior diameter	1
Jaw set 35 mm	1

- For removing power steering pump pulleys.
- Fits pulleys from 1-1/8" to 1-3/8".



ITEM	PIECES	AVAILABLE
107293	6	1 On Request

**MECHANIC STETHOSCOPE**

INDUSTRIAL DUTY



- Aluminum earpieces with plastic buds that isolate external noise.
- Ultra-thin diaphragm that amplifies sound.



ITEM	ROD LENGTH	AVAILABLE
107242	12"	1 ✓

**MECHANIC STETHOSCOPE**

PROFESSIONAL USE



- Aluminum earpieces with plastic buds that isolate external noise.
- Ultra-thin diaphragm that amplifies sound.



ITEM	ROD LENGTH	AVAILABLE
107246	12"	1 On Request

**ELECTRONIC STETHOSCOPE SET**

HEAVY DUTY NOISE CANCELLING

**3** PIECES



URREA



- Professional high-sensitivity microphone powered by a 9V battery.
- Flexible extension allows detection of noises in hard-to-reach areas.
- High-sensitivity headphones that block internal noise.
- Volume adjustment control.



ITEM	PIECES	AVAILABLE
2347	3	1 ✓

**FUEL INJECTOR CLEAN SET**

INDUSTRIAL DUTY

**40** PIECES

Content	
7 quick-disconnect fittings for fuel lines.	Repair ring set.
Schrader valve tool for adapters.	Ford® adapter.
Quick-change Nissan® "T" adapter.	Buoy with regulator, manometer, and hose.
Plastic box.	

- Connects to injector rails, temporarily eliminating the function of the fuel pump (check manufacturer specifications).



ITEM	PIECES	AVAILABLE
2336	40	1 ✓

**FUEL INJECTOR CLEANER**

INDUSTRIAL DUTY



- Stainless steel tank that provides greater durability.
- Gauge with plastic cover for added protection.



ITEM	CAPACITY	AVAILABLE
2335	100 psi	1 On Request

**PISTON RING OPRESSOR SET**

INDUSTRIAL DUTY

**7** PIECES



- The clamp can be used in a parallel or perpendicular position to the cylinder block.
- Bands marked with the application direction "bottom".
- Facilitates piston installation into the engine head.
- Capacity from 2-7/8" to 4-3/8".



ITEM	PIECES	AVAILABLE
2319	7	1 ✓

**WRINKLE BAND RING COMPRESSOR**

INDUSTRIAL DUTY



- Operates with a cam and requires a single adjustment by means of a screw for the first piston, then automatically remains adjusted for the others.



ITEM	RANGE	AVAILABLE
2318	3" to 5" / 76.2 mm to 127 mm	1 ✓

**RING COMPRESSORS**

INDUSTRIAL DUTY



2317

- Screws on each side of the ratchet are used to provide tension in the ratchet mechanism.
- Includes hex key, safety valve, and special steel spring.
- Mechanism with adjustable safety screws.



ITEM	HEIGHT		MINIMUM OPENING		MAXIMUM OPENING		AVAILABLE
	inches	mm	inches	mm	inches	mm	
2316	3-1/2"	88.9	2-1/8"	53.8	5"	127	1 ✓
2317	3-1/2"	88.9	3-1/2"	88.9	7"	177.8	1 ✓

**PISTON RING COMPRESSOR**

PROFESSIONAL USE



- Screws on each side of the ratchet are used to provide tension in the ratchet mechanism.
- Includes hex key, safety valve, and special steel spring.
- Clutch control with ratchet mechanism.



107221



107275



ITEM	ENGINE	HEIGHT		MINIMUM OPENING		MAXIMUM OPENING		AVAILABLE
		inches	mm	inches	mm	inches	mm	
107221	Gasoline	3-1/2"	89	2-1/8"	54	5"	127	1 On Request
107222	Gasoline	3-1/2"	89	3-1/2"	89	7"	177.8	1 On Request
107275	Diesel	5-7/8"	149	3-1/2"	89	7"	177.8	1 On Request

AUTOMOTIVE AND HYDRAULIC TOOLS

## ENGINE TOOLS & ACCESSORIES

### FLEXIBLE HOSE CLAMP



- For handling self-adjusting spring-type clamps.
- With a toothed locking mechanism.
- Facilitates replacement of water, oil, and fuel hoses.
- Clamp holder with a flexible cable.



ITEM	TOTAL LENGTH		☞	AVAILABLE
	inches	mm		
2328	9"	228.6	1	✓

### CV BOOT CLAMP PLIER



- For installing ear-type clamps on CV joint boots.

- Manufactured from chrome-plated alloy steel for greater strength.
- Long handles facilitates applying force to the clamp.



ITEM	MAXIMUM OPENING		TOTAL LENGTH		☞	AVAILABLE
	inches	mm	inches	mm		
2357	2"	50.8	9"	228.6	1	✓

### HIGH-PRESSURE ENGINE CLEANING GUN



- Non-continuous airflow.
- Interchangeable air connector.
- Suction-feed type.
- Recommended inner hose diameter: 3/8".



ITEM	CAPACITY	☞	AVAILABLE
PLM1	34 oz	1	On Request

### HOSE CLAMP



- Swivel jaws allow working in any position.
- Ratchet system ensures the clamp is firmly secured.
- Manufactured from chrome-plated alloy steel for greater strength.



ITEM	MAXIMUM OPENING		TOTAL LENGTH		☞	AVAILABLE
	inches	mm	inches	mm		
2356	2"	50.8	8-1/2"	215.9	1	✓

### CV BOOT CLAMP



- For installing ear-type clamps on CV joint boots.

- Manufactured from steel with phosphate finish that provides corrosion resistance.
- Long plastisol-coated handles facilitates applying force to the clamp.



ITEM	MAXIMUM OPENING		TOTAL LENGTH		☞	AVAILABLE
	inches	mm	inches	mm		
107254	1-1/16"	30	9"	230	1	On Request

### TIMING-ADVANCE TESTERS



107369



107368

- Xenon light provides excellent visibility for timing readings.
- Rotating knob displays timing advance degrees.
- Detects dwell, tachometer (RPM), and battery voltage.
- Digital monitor for easy reading.

ITEM	TYPE	ADVANCE	DWELL	VOLTAGE	TACH	☞	AVAILABLE
107369	Rotating knob	0 - 60	n/a	0 - 16 V	200 - 10 000 RPM	1	On Request
107368	Digital	0 - 60	0 - 99.9%	0 - 16 V	200 - 10 000 RPM	1	✓

### HOSE CLAMP PLIERS

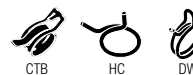

- For easy installation or removal of automotive clamps. Swivel jaws allow working in any position.
- Ratchet system ensures the clamp is firmly secured.
- Handles covered with dual plastisol coating.



ITEM	MAXIMUM OPENING		TOTAL LENGTH		☞	AVAILABLE
	inches	mm	inches	mm		
107376	2-1/2"	64 mm	9"	229 mm	1	On Request

### PISTON RING INSTALLER PLIER



- Manufactured from steel with satin finish.
- Plastisol-coated handles facilitates applying force to the clamp.



ITEM	MAXIMUM OPENING		TOTAL LENGTH		☞	AVAILABLE
	inches	mm	inches	mm		
107276	1-1/2"	141	5-9/16"	38.1	1	On Request

AUTOMOTIVE AND HYDRAULIC TOOLS



**ENGINE TOOLS & ACCESSORIES**

**FUEL INJECTION PRESSURE TESTER MASTER SET**



**34**  
PIECES



- Gauge with dual scale, 0-100 psi and 0-7 bar. Includes plastic protection.
- Includes 29 adapters for compatibility with most commercial brands.
- For pressure tests before and after the fuel flow reaches the vehicle's injector rail.



ITEM	PIECES	AVAILABILITY
2338	34	1 ✓

**AUTOMATIC TRANSMISSION PRESSURE TESTER AND ENGINE OIL**



**22**  
PIECES



- The set includes 22 adapters in inches and metrics with connection of quick coupler. Includes two pressure gauges for can measure highs and lows pressures.



ITEM	PIECES	CAPACITY	AVAILABILITY
2394	22	0-100 psi 0-400 psi	1 On Request

**RADIATOR PRESSURE TESTER MASTER SET**



**14**  
PIECES



**6**  
PIECES



- Injects pressurized air into the radiator via the pump and the proper adapter. If there is a leak, the gauge detects the pressure drop.



ITEM	PIECES	CAPACITY	AVAILABILITY
2370	14	35 psi	1 ✓

ITEM	PIECES	CAPACITY	AVAILABILITY
2370A	6	35 psi	1 On Request

**EXHAUST BACK PRESSURE TESTER**



- Allows testing exhaust back pressure through the oxygen sensor port.
- Includes adapters for M12 and M18 threaded oxygen sensors.
- Features dual scale in psi and bar. 1.80 m hose.
- Multicolored bands.



ITEM	MEASURING RANGE	AVAILABILITY
2398	0.5-1 bar / 0.7-15 psi	1 On Request

**FUEL INJECTION PRESSURE TESTER BASIC SET**



**11**  
PIECES



- Gauge with dual scale, 0-100 psi and 0-7 bar.
- Includes plastic protection and adapters for compatibility with most common vehicles from GM®, Ford®, and Honda®.



ITEM	PIECES	CAPACITY	AVAILABILITY
2334	11	0-100 psi	1 On Request

**FUEL PUMP AND VACUUM TESTER**



- Fuel pump tester for carbureted systems.
- Useful for checking internal fuel pump failures. Simply connect the tester to any point on the fuel line.



ITEM	COMPRESSION	VACCUM	AVAILABILITY
2341	1-15 psi	0-25"	1 On Request

**FAN CLUTCH WRENCH SET**



**4**  
PIECES

Size  
1-9/16"  
58 mm  
1-7/8"  
3-1/4"

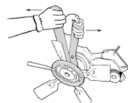

- Removes the radiator fan on almost all Ford vehicles. All wrenches have a total length of 16-1/8" (409 mm) and an auxiliary 1/2" (12.7 mm) drive.



ITEM	PIECES	AVAILABILITY
973	4	1 On Request

**FAN CLUTCH WRENCH SET**



**3**  
PIECES

Size  
36 mm  
3"  
2-3/8"



- Removes the radiator fan on almost all GM, Chrysler, and Jeep vehicles. All wrenches have a total length of 16-1/8" (409 mm) and an auxiliary 1/2" (12.7 mm) drive.



ITEM	PIECES	AVAILABILITY
974	3	1 ✓

## ENGINE TOOLS & ACCESSORIES

### TIMING TOOL SET FOR VOLKSWAGEN® - AUDI® - SEAT®

INDUSTRIAL DUTY **30 PIECES**



Item	Model	Engine
VOLKSWAGEN®	Polo (80-06)	Passat (96- )
	Lupo (97- )	Transporter (95- )
	Golf (80- )	Bora (98-06)
	Jetta (80- )	Beetle (98-06)
SEAT®	Ibiza (96-06)	Toledo (96-06)
	Cordoba (96-06)	Leon (96-06)
	A2 (00-06)	A8 (96-02)
AUDI®	A3 (96-03)	A6 (97-02)
	A4 (94-06)	TT (98-06)

- Includes locks and pins to secure the camshaft, crankshaft, injection pump pulley, and tensioner pulley in gasoline and diesel engines (see table).
- Allows major engine repairs while ensuring correct valve timing during reassembly.
- Enables replacement of the timing chain or belt without altering engine timing.



ITEM	PIECES	AVAILABILITY
2382	30	On Request

### ENGINE STAND

PROFESSIONAL USE



- Two swivel front wheels.

ITEM	LOAD CAPACITY	AVAILABILITY
137050	1,000 lb	On Request

### BASIC TIMING TOOL SET FOR FORD®, MAZDA® AND VOLVO®

INDUSTRIAL DUTY **5 PIECES**



Item	Model	Engine
FORD®	Cougar (98-01)	Fusion (02-12)
	Fiesta (95-15)	Mondeo (93-15)
	Focus (98-14)	Transit (06-12)
MAZDA®	MX-5 (05-15)	5 (05-15)
	3 (03-14)	6 (02-13)
VOLVO®	C30 (06-13)	S80 (07-11)
	S40 (06-12)	V50 (04-12)

- Includes a calibration plate and basic pins to lock and align the camshaft valves in Ford®, Mazda®, and Volvo® engines.
- Allows replacement of the timing chain without altering engine timing.
- Enables major engine repairs while ensuring correct valve timing during reassembly.



ITEM	PIECES	AVAILABILITY
2385	5	On Request

### VALVE LAPPING TOOL

INDUSTRIAL DUTY



- Solid wooden handle for positioning valves.
- Includes two suction cups for use when handling valves without flat-head grooves.



ITEM	DESCRIPTION	AVAILABILITY
2395	Meets most valves range 1-1/8" to 1-3/8"	✓

### BASIC TIMING TOOL SET FOR RENAULT®

INDUSTRIAL DUTY **4 PIECES**



Brand	Model	Engine
RENAULT®	Clio	1.4 16V (K4J)
	Laguna	1.6 16V (K4M)
	Megane	1.8 16V (F4p)
NISSAN®	Traffic	2.0 16V (F4R)

- Includes locks and pins to block and align the camshaft in Renault® gasoline engines.
- Allows major engine repairs while ensuring correct valve timing during reassembly.
- Enables replacement of the timing chain without altering engine timing.



ITEM	PIECES	AVAILABILITY
2386	4	On Request

### DIESEL ENGINE COMPRESSION TESTER

INDUSTRIAL DUTY



- Requires the use of an adapter depending on the engine type (see adapter table for compression tester).



ITEM	COMPRESSION RANGE	SCREW	AVAILABILITY
2340D	0-1000 psi	5/16"	✓

### ADAPTERS FOR CHECKING DIESEL ENGINES COMPRESSION

INDUSTRIAL DUTY



ITEM	ADAPTER	FOR	AVAILABILITY
2340DA	Adapter M14 x 1.25	"Ford®, International Navistar®"	✓
2340DC	Injector type adapter	"Cummins®, Dodge®"	✓
2340DE	Adapter M10 x 1.25	"General Motors®, Hummer H1-Alfa®"	✓
2340DF	Adapter M21	"Mitsubishi-Fuso®, John Deere/Alis Chalmers®, Bedford®, International Harvester®, Mack Truck®, Massey Ferguson®"	✓
2340DG	Adapter M10 x 1.25	"Chevette® / Isuzu®, LUV/Isuzu®, General Motors®, Toyota®"	✓
2340DH	Adapter M8 x 1.00	"Ford®, Sprinter®/ Mercedes®/Freightliner®/Dodge®"	✓
2340DM	Adapter injector 3/8"	"Caterpillar®, J.I. Case®, John Deere®"	✓
2340DN	Adapter M12 x 1.25	"Audi®, BMW®, Deutz®, GMC®, Hino®, Isuzu®, Lincoln®, Mercedes Benz®, Nissan®, Volvo®, Volkswagen®"	✓
2340DP	Adapter M24 x 1.50	"Cummins®, Dodge J.I. Case®"	✓

AUTOMOTIVE AND HYDRAULIC TOOLS

**ENGINE TOOLS & ACCESSORIES**

**COMPRESSION TESTER FOR GASOLINE ENGINES**

**URREA**  
TOOL FOR PROFESSIONALS



- Gauge with a dual scale (0-300 psi and 0-21 bar). Includes plastic protection.
- Includes adapter for M14 and M18 threads.

ITEM	COMPRESSION RANGE	☞ AVAILABLE
2340	0-300 lb/inch <sup>2</sup>	1 ✓

**COMPACT SPARK PLUG COMPRESSION TESTER**

**SURTEK**  
TOOL FOR PROFESSIONALS



- Gauge with a dual scale (50-300 psi and 3-21 bar).

ITEM	MINIMUM PRESSURE	MAXIMUM PRESSURE	☞ AVAILABLE
107367	50 psi	300 psi	1 ✓

**COMPRESSION TESTER SET**

**SURTEK**  
TOOL FOR PROFESSIONALS



**11**  
PIECES



- Gauge with a dual scale (0-100 psi and 0-7 bar). Includes plastic protection.
- Plastic case for better storage.

ITEM	MAXIMUM PRESSURE	☞ AVAILABLE
107277	100 psi (7 Bar)	1 On Request

**BUS & CROSS LUG NUT WRENCHES**

**BUS LUG NUT WRENCH**

**URREA**  
TOOL FOR PROFESSIONALS



**INCHES** 6 6  
**METRIC**



Hex Socket

- Forged from alloy steel for superior torque resistance.
- Phosphated finish for excellent corrosion resistance.
- New deep hex socket provides greater security and control when engaging the stud, preventing slippage.

**BULK**

ITEM	LENGTH	OPENING SIZES		RECOMMENDED SHAFT	☞ AVAILABLE
		A	B		
UCD33*	17"	11/16"	33 mm	3RB	1 ✓
UCD5	17"	7/8"	15/16"	3RB	1 On Request
UCD6	17"	1"	1-1/16"	3RB	1 ✓
UCD7	17"	7/8"	1-1/8"	3RB	1 ✓
UCD8	17"	1"	1-1/8"	3RB	1 ✓
UCD9	17"	1-1/16"	1-1/4"	3RB	1 ✓

**BUS LUG NUT WRENCH BARS**

**URREA**  
TOOL FOR PROFESSIONALS



- Forged from alloy steel for superior torque resistance.
- Phosphated finish for excellent corrosion resistance.

**BULK**

ITEM	SIZE	DESCRIPTION	☞ AVAILABLE
1RB	11/16" x 16"	For CD5, CD6, CD7, CD8, CD9 and CD33	1 On Request
3RB	3/4" x 16"	For UCD5, UCD6, UCD7, UCD8, UCD9 and UCD33	1 On Request
2RB	7/8" x 15-3/4"	For CD10 and UCD10	1 ✓

**SQUARE LUG NUT TRUCK WRENCH**

**URREA**  
TOOL FOR PROFESSIONALS



**INCHES** 6 4



Square Socket Hex Socket

- Forged from alloy steel for superior torque resistance.
- Phosphated finish for excellent corrosion resistance.
- New deep hex socket provides greater security and control when engaging the stud, preventing slippage.

**BULK**

ITEM	LENGTH	OPENING SIZE		RECOMMENDED SHAFT	☞ AVAILABLE
		HEX (A)	SQUARE (B)		
UCD10	18"	1-1/2"	13/16"	2RB	1 On Request

**TRUCK WHEEL WRENCHES**

**SURTEK**  
TOOL FOR PROFESSIONALS



**INCHES** 4 6



Square Socket Hex Socket

- Forged from alloy steel for superior torque resistance.
- Black Oxide finish for excellent corrosion resistance.
- Handle included.

**BULK**

ITEM	LENGTH	HEXAGONAL SOCKET "A"	HEXAGONAL SOCKET "B"	SQUARE SOCKET "B"	☞ AVAILABLE
<b>Double hexagonal socket</b>					
70	18"	7/8"	15/16"	n/a	1 On Request
72	16"	1"	1-1/16"	n/a	1 On Request
77	16"	1-1/16"	1-1/4"	n/a	1 On Request
78	16"	1-1/8"	7/8"	n/a	1 On Request
82	18"	30 mm	33 mm	n/a	1 On Request
<b>Hexagonal socket and square socket</b>					
75	16"	15/16"	1--1/8"	13/16"	1 On Request
79	16"	1-1/2"	n/a-	13/16"	1 On Request

## BUS & CROSS LUG NUT WRENCHES

### MULTIFUNCTIONAL CROSS LUG WRENCH SET



INCHES  
METRIC



URREA



5  
PIECES

Contents	
Cross wrench	1
7424H - 3/4"	1
7426H - 13/16"	1
7428H - 7/8"	1
7417M - 17M	1



- Forged from alloy steel for greater torque resistance.
- Phosphate finish offering corrosion resistance.
- Pry bar tip for removing hub caps.
- Bar to connect a high leverage handle 26H1B (not included).

BULK

ITEM	LENGTH	A	B	END	C	D	☞	AVAILABLE
LLC18MJ	18"	1/2" square drive	1/2" square drive		Pry bar	End for UAS fitting	1	✓

### MULTIFUNCTIONAL CROSS LUG WRENCH



INCHES  
METRIC



URREA



- Forged from alloy steel for greater torque resistance.
- Phosphate finish offering corrosion resistance.
- Pry bar tip for removing hub caps.
- Bar to connect a high leverage handle 26H1B (not included).

BULK

ITEM	LENGTH	A	B	END	C	D	☞	AVAILABLE
LLC18M	18"	1/2" square drive	1/2" square drive		Pry bar	End for UAS fitting	1	✓

### CROSS LUG WRENCHES



URREA



UCL20

- Forged from alloy steel for greater torque resistance.
- Phosphate finish offering corrosion resistance.
- Hex opening provides greater safety and control when coupled to the stud, preventing slippage.

BULK

ITEM	LENGTH	FOR	OPENING SIZES				☞	AVAILABLE
			A	B	C	D		
UCL18	18"	For cars and pick-ups	17 mm	3/4"	7/8"	13/16"	1	✓
UCL20	20"	For cars and pick-ups	17 mm	3/4"	7/8"	13/16"	1	On Request
UCL5	22"	For cars and pick-ups	17 mm	3/4"	7/8"	13/16"	1	✓
UCL26F	26"	For trucks	1"	7/8"	15/16"	13/16"	1	✓
UCL26	26"	For trucks	1-1/16"	1"	1-1/8"	7/8"	1	✓

### LUG WRENCHES



SURTEK

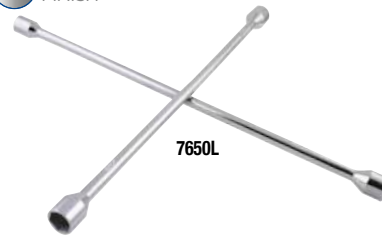

7650L

- Forged from steel for greater torque resistance.
- Chrome finish offering corrosion resistance.
- Meet GGG-W644B standard.

BULK

ITEM	LENGTH	FOR	OPENING SIZES				☞	AVAILABLE
			A	B	C	D		
7651N	14"	Car	3/4"	7/8"	13/16"	17 mm	5	On Request
7651C	18"	Car	3/4"	7/8"	13/16"	17 mm	6	On Request
7652C	20"	Car	3/4"	7/8"	13/16"	17 mm	6	On Request
7650L	26"	Minibus	1"	1-1/6"	21 mm	24 mm	1	On Request
7650S	26"	Van	7/8"	1"	1-1/8"	1-1/16"	1	On Request

### FOLDING LUG WRENCH



SURTEK



- Forged from steel for greater torque resistance.
- Chrome finish offering corrosion resistance.

ITEM	LENGTH	OPENING SIZES				☞	AVAILABLE
		A	B	C	D		
LLC14P	14"	3/4"	7/8"	13/16"	17 mm	4	On Request

**ELECTRIC SYSTEM**

**PORTABLE JUMP STARTER SET WITH 1 USB PORT**



**6 000 mAh**  
BATTERY CAPACITY

**200 A**  
STARTER CURRENT

**3**  
PIECES



Content	
AB6	Jump starter 6,000 mAh 1
107313	Battery terminal cleaner 1
EMSC	Multipurpose case 1

- Compact and lightweight design.
- Provides emergency starting for vehicles with low or discharged battery.
- Equipped with 1 USB port to charge electronic devices.
- Includes jumper cables with safety clamps.
- Rechargeable battery with indicator lights.
- Carrying case for storage and transport.

ITEM	PIECES	AVAILABILITY
JAB	3	On Request



**CCA BOOSTER CABLES**



**6 AWG**

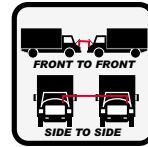

- CCA cable, 6 AWG gauge for high performance.
- Clamps coated with electrostatic paint for protection and corrosion resistance.
- Copper-plated sheet alligator clamps.

ITEM	GAUGE	LENGTH	CAPACITY	AVAILABILITY
CPA6A	6 AWG	11.4 ft	350 A	On Request

**BOOSTER CABLES**



**4 AWG**  
200A

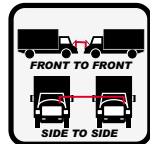

- 100% copper cable, 4 AWG gauge for maximum performance.

- Clamps coated with electrostatic paint for protection and corrosion resistance.
- Copper-plated steel alligator clamps.

ITEM	GAUGE	LENGTH	CAPACITY	AVAILABILITY
200	6 AWG	10 ft	250 A	On Request
200A	4 AWG	15.7 ft	400 A	On Request

**JUMPER CABLES**



**8 AWG**  
107343

- CCA cable, 8 AWG gauge for high performance.
- Clamps coated with electrostatic paint for protection and corrosion resistance.
- Copper-plated steel sheet alligator clamps.

ITEM	GAUGE	LENGTH	CAPACITY	AVAILABILITY
107344	8 AWG	10 ft	175 A	On Request
107343	8 AWG	12 ft	175 A	On Request

**9V COMPUTER MEMORY SAVER**



- Maintains radio, clock, and computer functions memory when the battery is disconnected.

ITEM	INPUT	AVAILABILITY
2345	9V battery	On Request

**BATTERY HYDROMETER**



- Provides accurate measurements in both cold and hot conditions.
- For 6V, 12V, and 24V systems.

ITEM	CAPACITY	AVAILABILITY
107365	15.6 - 18.4 lbf/in <sup>2</sup>	✓

**BATTERY POST AND TERMINAL CLEANER**



- Cleans corrosion from battery posts, terminals, and cable connectors.

ITEM	BRUSH LENGTH	AVAILABILITY
107313	1-7/64"	On Request

AUTOMOTIVE AND HYDRAULIC TOOLS

## ELECTRIC SYSTEM

### BATTERY TERMINAL SPREADER AND CLEANER

INDUSTRIAL DUTY



- Serrated tip design allows easy removal of corrosion.
- Spreads and cleans battery terminals.
- Extends terminal service life without damaging the terminal walls.

ITEM	TOTAL LENGTH		☞	AVAILABLE
	inches	mm		
2312	7-3/8"	187,3 mm	1	✓

### FUEL INJECTION NOID LIGHT TEST SET

INDUSTRIAL DUTY



11 PIECES



- Tests for the presence of the electrical signal in fuel injection systems.

PLASTIC BOX

ITEM	PIECES	☞	AVAILABLE
2348	11	1	✓

### IN-LINE SPARK TESTER

INDUSTRIAL DUTY



28 V<sub>DC</sub> VOLTAGE



- Forged alloy steel body for maximum strength and durability.
- Do not use with impact tools.
- Can be used by hand or with a 5/8" wrench.

ITEM	CAPACITY	LENGTH		☞	AVAILABLE
		inches	mm		
2355	0-28 VDC	9-3/4"	247	1	✓

## SUSPENSION TOOLS

### MACPHERSON STRUT SPRING COMPRESSOR

INDUSTRIAL DUTY



9 PIECES



- Forged alloy steel body for superior strength.
- Do not use with impact tools.
- Compresses springs on MacPherson-type struts using the three-claw jaws.
- Can be used with 1/2" drive or with 24 mm socket or wrench.

ITEM	MAXIMUM PRESSURE CAPACITY	☞	AVAILABLE
2323A	2,500 lb/ft	1	✓

### VALVE SPRING COMPRESSOR

INDUSTRIAL DUTY



6 PIECES



ITEM	MAXIMUM PRESSURE CAPACITY	WEIGHT	☞	AVAILABLE
2323	2,500 lb/ft	5.73 lb	1	On Request

### MACPHERSON STRUT SPRING HOOK COMPRESSOR

INDUSTRIAL DUTY



2 PIECES



- Forged alloy steel body provides greater strength.
- Do not use with impact tools.
- Can be used with 5/8" socket or wrench.

ITEM	MAXIMUM OPENING	LENGTH	☞	AVAILABLE
2320	9"	12"	1	On Request

### MACPHERSON STRUT SPRING

PROFESSIONAL USE



2 PIECES



- Forged steel body provides greater strength.
- Do not use with impact tools.
- Can be used with 5/8" socket or wrench.

ITEM	LENGTH		☞	AVAILABLE
	inches	mm		
107256	26"	600	1	On Request

### STRUT NUT SOCKET FOR AUDI® AND VW®

INDUSTRIAL DUTY



- Designed for easy removal of the strut tower nut on VW® and Audi® vehicles.
- Use with a 7/8" (22 mm) wrench.
- Constructed from Chrome-Molybdenum (Cr-Mo) steel.
- Blued finish.
- IMPORTANT: Not recommended for use as an impact tool, as it is not designed for that purpose.

ITEM	HEXAGON	LENGTH		☞	AVAILABLE
		inches	mm		
2327	7/8"	1-3/4"	44.45	1	✓

### INNER TIE ROD TOOL

INDUSTRIAL DUTY



9 PIECES



- For removal and installation of inner tie rods without full hex, eliminating the need to remove the steering rack.
- Includes durable plastic case for easy storage and transport.

PLASTIC BOX

ITEM	PIECES	☞	AVAILABLE
2324	9	1	✓

### INNER TIE TOOL SET

PROFESSIONAL USE



8 PIECES



Content	
Crowfoot wrenches 1-3/16", 1-1/4", 1-5/16", 1-7/16", 14 mm, 17 mm, 33.6 mm	7
Extra-long steel bar 20" (50.8 mm)	1

- For removal and installation of inner tie rods that do not have a complete hex, without the need to remove the rack.
- Includes plastic case for easy storage and transport.

ITEM	PIECES	☞	AVAILABLE
107377	8	1	On Request

AUTOMOTIVE AND HYDRAULIC TOOLS

**GENERAL USE**

**MECHANIC'S ROLLING SEAT WITH DRAWERS**



**HEAVY DUTY** **4 SWIVEL CASTERS**



- Reinforced chrome-plated steel structure.
- PVC-covered padded seat.
- Includes 2 side drawers.
- Includes 1 under-seat storage tray.
- Includes 2 removable tool trays.
- 4 casters, 2 with brakes (locking casters).



ITEM	MAXIMUM HEIGHT	SEAT DIMENSION	MAXIMUM CAPACITY	AVAILABLE
9984	18-1/8"	9-27/32" x 14-3/16"	330 lb	1 On Request

**REPLACEMENT MECHANIC STOOL CASTERS**



**INDUSTRIAL DUTY**



F9984

R9984

- Wheel material: polypropylene.
- Support material: carbon steel.



ITEM	DESCRIPTION	FOR ITEM	AVAILABLE
F9984	Swivel caster with brake (Locking)	9984	1 On Request
R9984	Swivel caster without brake (Non-Locking)	9984	1 On Request

**MECHANIC'S ROLLING STOOL**



**PROFESSIONAL USE** **4 SWIVEL CASTERS**



- Reinforced steel structure with electrostatic paint.
- PVC-covered padded seat.
- Includes built-in tool storage compartment.
- 4 casters (2 made of PVC).



ITEM	MAXIMUM HEIGHT	SEAT DIMENSION	MAXIMUM CAPACITY	AVAILABLE
137071	14-3/8"	14-3/16"	198 lb	1 On Request

**MECHANIC STOOL WITH HEIGHT ADJUSTMENT LEVER**



**HEAVY DUTY** **SWIVEL SEAT** **ADJUSTABLE HEIGHT**



- Metal base.
- Padded backrest and seat.
- Chrome steel structure.
- With non-slip caps.
- Backrest dimensions: 300 x 150 mm.



ITEM	MINIMUM HEIGHT	MAXIMUM HEIGHT	SEAT DIAMETER	MAXIMUM CAPACITY	AVAILABLE
9985	27-15/16"	32-9/32"	13-3/4"	330 lb	1 On Request

**PADDLED SWIVEL MECHANIC STOOL**



**INDUSTRIAL DUTY** **SWIVEL SEAT**



- Heavy-duty bench with four chrome steel legs.
- Padded surface.
- With non-slip feet.
- Seat diameter: 350 mm.



ITEM	HEIGHT	CAPACITY	DIAMETER	AVAILABLE
9988	29-1/2"	330 lb	13-3/4"	1 On Request

**PADDLED MECHANIC STOOL**



**PROFESSIONAL USE**



- Heavy-duty stool with four satin-finish steel legs.
- Padded surface.
- With non-slip glides.



ITEM	HEIGHT	SEAT DIAMETER	MAXIMUM CAPACITY	AVAILABLE
137079	30-5/16"	14"	265 lb	1 On Request

**PADDLED SWIVEL MECHANIC STOOL**



**PROFESSIONAL USE** **4 SWIVEL CASTERS**



- Heavy-duty stool with pneumatic height adjustment.
- Padded surface.
- With tray for tools or small parts.



ITEM	MINIMUM HEIGHT	MAXIMUM HEIGHT	SEAT DIAMETER	MAXIMUM CAPACITY	AVAILABLE
137074	15"	19-1/4"	15"	300 lb	1 On Request

AUTOMOTIVE AND HYDRAULIC TOOLS

## GENERAL USE

### MECHANIC CREEPERS

**PROFESSIONAL USE** **6 SWIVEL CASTERS** **ADJUSTABLE HEADREST 3 POSITIONS**

**SURTEK**  
TOOLS FOR SPECIALISTS



VIDEO



- Headrest adjustable to three positions.
- Strong and durable metal structure.
- Padded vinyl cover for resistance and comfort.
- Swivel casters.
- Functions as a creeper or seat.



ITEM	CAPACITY	LENGTH		HEIGHT			AVAILABLE
		inches	mm	inches	mm		
137067	330 lb	48"	1,219	3"	76	1	On Request

### MECHANIC CREEPERS

**PROFESSIONAL USE** **6 SWIVEL CASTERS** **ADJUSTABLE HEADREST 3 POSITIONS**

**SURTEK**  
TOOLS FOR SPECIALISTS



- 3-position adjustable headrest.
- Strong and durable tubular steel frame.
- Padded vinyl cover for durability.
- Swivel casters.



ITEM	CAPACITY	LENGTH		HEIGHT			AVAILABLE
		inches	mm	inches	mm		
137068	330 lb	40"	1,016	2-1/2"	63.5	1	On Request

### MECHANIC CREEPERS

**PROFESSIONAL USE** **6 SWIVEL CASTERS**

**SURTEK**  
TOOLS FOR SPECIALISTS



137070

- Strong and durable steel structure.
- Padded vinyl cover for durability.
- Swivel casters.



ITEM	CAPACITY	LENGTH		HEIGHT			AVAILABLE
		inches	mm	inches	mm		
137070	120 kg	35-1/2"	914	3-1/4"	83	1	On Request
137069	150 kg	40"	1,016	2-1/2"	63.5	1	On Request

### ADJUSTABLE CUSHIONED MECHANIC CREEPER

**INDUSTRIAL DUTY** **6 SWIVEL CASTERS** **ADJUSTABLE HEADREST 3 POSITIONS**

**URREA**  
INDUSTRIAL DUTY



- Headrest adjustable to three positions.
- Durable tubular aluminum structure with electrostatic paint.
- Comfortable padded vinyl cover for durability.
- Swivel casters



ITEM	CAPACITY	LENGTH		HEIGHT			AVAILABLE
		inches	mm	inches	mm		
9995A	330 lb	43"	1,090	6-11/16"	170	1	On Request

### CUSHIONED MECHANIC CREEPER

**INDUSTRIAL DUTY** **4 SWIVEL CASTERS**

**URREA**  
INDUSTRIAL DUTY



- Durable tubular steel frame with powder electrostatic paint.
- Comfortable padded vinyl cover for durability.
- Swivel casters.



ITEM	CAPACITY	LENGTH		HEIGHT			AVAILABLE
		inches	mm	inches	mm		
9995	330 lb	40"	1,020	4-11/32"	110	1	On Request

### PLASTIC MECHANIC CREEPER

**INDUSTRIAL DUTY** **6 SWIVEL CASTERS** **MAGNETIC TRAY**

**URREA**  
INDUSTRIAL DUTY



9991

- Manufactured from polypropylene with additives that extend service life.
- Padded headrest.
- 2 side magnetic compartments/trays for tool storage.



ITEM	CAPACITY	LENGTH		HEIGHT			AVAILABLE
		inches	mm	inches	mm		
9991	330 lb	36"	910	4-3/4"	120	1	On Request
9991A	242.5 lb	40"	1,020	4-3/4"	120	1	On Request



**GENERAL USE**

**MECHANIC CREEPERS**



**NEW**



**137073**

- Manufactured from polypropylene.
- Padded headrest.
- 2 side compartments/trays for tool storage.



ITEM	CAPACITY	LENGTH		HEIGHT		☞	AVAILABLE
		inches	mm	inches	mm		
<b>137073</b>	120 kg	40"	1,016	4-1/2"	114	1	<b>On Request</b>

**MECHANIC CREEPER CASTERS**



**NEW**



**R137071      R137068      R137066      R137073**



ITEM	SWIVEL WHEEL	FOR ITEM	☞	AVAILABLE
<b>R137071</b>	With threaded latch	137071	1	<b>On Request</b>
<b>R137068</b>	With latch	137067, 137068, 137069, 137070	1	<b>On Request</b>
<b>R137066</b>	With plate	137066	1	<b>On Request</b>
<b>R137073</b>	With plate	137073	6	<b>On Request</b>

**MECHANIC CREEPER CASTERS**



**R9995      R9995A      R9991A      R9991**



ITEM	SWIVEL WHEEL	FOR ITEM	☞	AVAILABLE
<b>R9995</b>	2 1/2" with latch	9995	1	<b>On Request</b>
<b>R9995A</b>	3 1/2" with latch	9995A	1	<b>On Request</b>
<b>R9991A</b>	3" with plate	9991A	1	<b>On Request</b>
<b>R9991</b>	2" with plate	9991	1	<b>On Request</b>

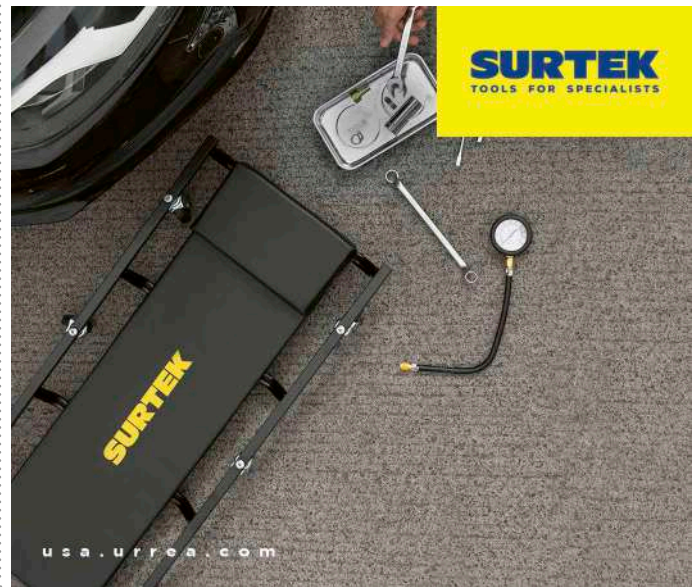

**AIR HOSE REEL**



- Ideal for preventing liquid spills and air leaks.
- Increases productivity by keeping the hose readily accessible.
- Improve workplace safety.
- Protect and extend hose service life.



ITEM	23RW350	23RW450	23R0350	23RG350	23R0450
MAX PRESSURE	300 psi	300 psi	2250 psi	4000 psi	2000 psi
DIAMETER	3/8"	1/2"	3/8"	3/8"	1/2"
LENGTH	50 ft	50 ft	50 ft	50 ft	50 ft
HOSE INLET (FEMALE NPT)	1/2 NPT	1/2 NPT	1/2 NPT	1/2 NPT	1/2 NPT
HOSE OUTLET (MALE NPT)	3/8 NPT	1/2 NPT	3/8 NPT	3/8 NPT	1/2 NPT
<b>APPLICATIONS</b>					
GREASE				•	
OIL			•	•	•
WATER	•	•	•	•	•
AIR	•	•	•	•	•
☞	1	1	1	1	1
AVAILABLE	<b>On Request</b>	<b>On Request</b>	<b>On Request</b>	<b>On Request</b>	<b>On Request</b>

## GENERAL USE

### MAGNETIC TRAYS



URREA



- Manufactured from stainless steel.
- Rubber magnet base resistant to oil and gasoline.
- Coated with powder electrostatic paint for corrosion resistance.



ITEM	TYPE	DIMENSIONS		☞	AVAILABLE
		inches	cm		
2302	Round	6"	15 cm	1	On Request
2303	Rectangle	5-1/2" x 9-7/16"	14 cm x 24 cm	1	On Request
2305	Rectangle	11" x 11-13/16"	28 cm x 30 cm	1	On Request

AUTOMOTIVE AND HYDRAULIC TOOLS

### MAGNETIC TRAYS



SURTEK



URREA



- Manufactured from stainless steel.
- Rubber base resistant to oil and gasoline.



ITEM	TYPE	DIMENSIONS		☞	AVAILABLE
		inches	mm		
107362	Rectangle	5-1/2"	140	1	On Request
107361	Round	6"	152	1	On Request

### TELESCOPIC INSPECTION MIRROR



URREA



- Ideal for inspecting hard-to-reach areas.
- Plastisol handle for better grip.



ITEM	MIRROR SIZE	MINIMUM EXTENSION		MAXIMUM EXTENSION		☞	AVAILABLE
		inches	mm	inches	mm		
2373	2-1/8" x 3-1/2"	11-1/4"	286	15-1/4"	387	1	✓

### TELESCOPIC INSPECTION MIRRORS



SURTEK

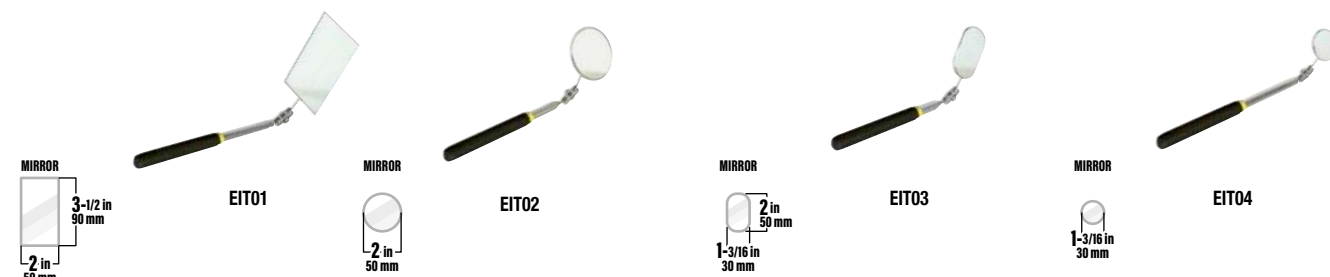

ITEM	MIRROR SIZE	MINIMUM EXTENSION		MAXIMUM EXTENSION		☞	AVAILABLE
		inches	mm	inches	mm		
EIT01	2" x 3-1/2"	11-3/4"	298	17-5/16"	440	1	On Request
EIT02	2"	10-1/8"	258	15-3/4"	400	1	On Request
EIT03	1-3/16" x 2"	8"	203	28-1/8"	715	1	On Request
EIT04	1-3/16"	9-1/4"	235	14-3/4"	375	1	On Request

**GENERAL USE**

**MAGNETIC PICK-UP TOOLS**

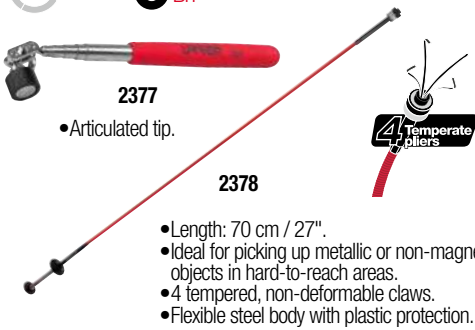

- Articulated tip.

- Length: 70 cm / 27".
- Ideal for picking up metallic or non-magnetic objects in hard-to-reach areas.
- 4 tempered, non-deformable claws.
- Flexible steel body with plastic protection.



- With light.
- Pen-style design with pocket clip.
- Durable bulb that provides excellent energy efficiency.



**2375**



**2376**



**2346**

- Includes pocket clip.
- Reaches tools and small parts in hard-to-reach areas.

ITEM		2377	2378	2374	2346	2375	2376
MINIMUM EXTENSION	inches	8"	-	6-11/16"	4-1/2"	6-7/8"	6-7/8"
	mm	203 mm	-	170 mm	114 mm	175 mm	175 mm
MAXIMUM EXTENSION	inches	27-2/8"	-	26"	16-1/4"	26-5/16"	26-5/16"
	mm	695 mm	30 mm	660 mm	413 mm	668 mm	668 mm
MAX. LOAD CAPACITY		7.94 lb	1.10 lb (magnet) 11 lb (claws)	2.20 lb	1 lb	3.53 lb	7.94 lb
⊞		1	1	1	1	1	1
AVAILABLE		✓	✓	✓	✓	✓	✓

**TELESCOPIC MAGNETIC PICK-UP TOOLS**



**MT01**



**MT02**



**MT03**



**MT04**

- Retrieves small objects from hard-to-reach areas.

- Flexible cable/shaft allows access to hard-to-reach areas.

- With light to facilitate object search.
- Includes 3 LSR44 1.5 V batteries.

ITEM		MT01	MT02	MT03	MT04
TYPE		Telescopic	Telescopic	Flexible	Flexible
MINIMUM EXTENSION	inches	5-1/8"	5-1/8"	-	-
	mm	130 mm	130 mm	-	-
MAXIMUM EXTENSION	inches	21-27/32"	25-3/4"	21"	23"
	mm	555 mm	650 mm	550 mm	584 mm
LIFT CAPACITY		3,3 lb	1 lb	1 lb	4.4 lb
⊞		1	1	1	1
AVAILABLE		On Request	On Request	On Request	On Request

**SEAL & O-RING PICK**



- For installing or removing seals and O-rings.
- Double-ended with hook and offset tips.
- Knurled handle.
- Chrome plated.

ITEM	LENGTH	⊞	AVAILABLE
	inches	mm	
107299	8 1/2"	215	1 On Request

**GASKET SCRAPER**



- Square bar design.
- Phosphate finish.
- 6" long bar.
- 3/8" square bar.

ITEM	BLADE WIDTH	⊞	AVAILABLE
	inches	mm	
2332	1-1/16"	27 mm	1 ✓

**MULTIPURPOSE SCRAPER**



- Manufactured from steel.
- Vinyl-coated handle.
- Ideal for removing paint, labels, decals, and more.

ITEM	BLADE WIDTH	⊞	AVAILABLE
	inches	mm	
120128	1-1/2"	38.1	1 On Request

## GENERAL USE

### TRIM PANEL REMOVER



URREA



- 6" chrome-plated steel bar.
- Ideal for removing most door panel clips.
- High-strength cellulose acetate handle.

ITEM	DESCRIPTION	AVAILABILITY	AVAILABLE
2331	Trim Panel Remover	1	✓

### TRIM PANEL REMOVER

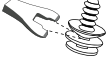

SURTEK

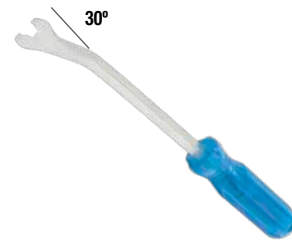

- 6" satin-finish steel bar.
- Ideal for removing most door panel clips.
- High-strength virgin plastic handle.

ITEM	DESCRIPTION	AVAILABILITY	AVAILABLE
107379	Upholstery Clip Remover	1	✓

### THREAD REPAIR KIT



48  
PIECES



Item	Size	Quantity
Description	Size	
Metric thread taps	14 x 1.50, 12 x 1.75, 12 x 1.50, 12 x 1.25, 11 x 1.50, 10 x 1.50, 10 x 1.25, 10 x 1.00, 8 x 1.25, 6 x 1.00 mm	10
Standard thread taps	9/16"-12, 1/2"-13, 7/16"-14, 3/8"-16, 5/16"-18, 1/4"-20	6
Fine thread tap	9/16"-18, 1/2"-20, 7/16"-20, 3/8"-24, 5/16"-24, 1/4"-28	6
Metric thread dies	14 x 1.50, 12 x 1.75, 12 x 1.50, 12 x 1.25, 11 x 1.50, 10 x 1.50, 10 x 1.25, 10 x 1.00, 8 x 1.25, 6 x 1.00 mm	10
SAE NC thread dies	5/8"-11, 9/16"-12, 1/2"-13, 7/16"-14, 3/8"-16, 5/16"-18, 1/4"-20	7
SAE NF Fine thread dies	5/8"-18, 9/16"-18, 1/2"-20, 7/16"-20, 3/8"-24, 5/16"-24, 1/4"-28	7
SAE rethreader file, 8 size	24, 20, 18, 16, 14, 13, 12, 11	1
Metric rethreader file, 8 sizes	3.00, 2.50, 2.00, 1.75, 1.50, 1.25, 1.00, 0.75 mm	1

- Allows restoration of damaged threads, preferably used for engine blocks.
- Designed for American, European, and Asian vehicles

ITEM	PIECES	DESCRIPTION	AVAILABILITY	AVAILABLE
972	48	In inches and metrics	1	✓

### FENDER COVER



- Manufactured from flexible vinyl.
- Reinforced seams and straps.

BULK

ITEM	SIZE	AVAILABILITY
	inches mm	
E451	38-31/32" x 19-1/4" 990 x 490	1 On Request

## HYDRAULIC FLOOR JACK

### HYDRAULIC FLOOR JACK



4 409 LB  
MAX. CAPACITY



Hydraulic stroke limitation.



Safety valve against overload.



Descent control device.



T-handle.

- Load approach pedal.
- Incorporates a safety device to prevent an involuntary or accidental lowering of the load. If it occurs, the lifting arm will be blocked 12.59 inches (320 mm) from the ground.

ITEM	2460
CAPACITY	4,409 lb
MINIMUM HEIGHT	6-1/2"
MAXIMUM HEIGHT	31-3/32"
TOTAL LENGTH	48"
WEIGHT	48.5 lb
AVAILABILITY	1
AVAILABLE	On Request



Metal wheels for items.



• Long-range.



URREA



**HYDRAULIC BOTTLE JACKS**

# HYDRAULIC BOTTLE JACKS USES & PRECAUTIONS



**INITIAL OPERATION**

- Verificar que el nivel de aceite sea el óptimo antes de intentar levantar cualquier carga.
- It is possible that during transportation, air may have accumulated inside the hydraulic system. To bleed the system and ensure optimal operation, the following recommendations must be followed:
  1. Open the release/relief valve.
  2. Pump the handle several times to lubricate the system and release accumulated air.
  3. Close the release valve.

**! PRECAUTIONS:**

- Never exceed the maximum ram travel indicated on the label.
- Do not attempt to move the jack when it is loaded.
- Always use the hydraulic jack for lifting only.
- Place the jack under the lifting point recommended by the vehicle manufacturer.



Do not exceed maximum capacity



Use auxiliary stands/ supports.



Use wheel chocks if necessary.



Use only on level and solid surfaces.



Use HL or HM hydraulic oil



Repairs by qualified personnel only.

**HYDRAULIC BOTTLE JACK**



Hydraulic stroke limitation.



Safety valve against overload.



Vertical and horizontal use.

- Ideal for lifting cars and trucks.
- Equipped with a lowering control device.
- Wide and solid base provides excellent support and stability during operation.
- Three-piece galvanized telescopic handle.
- Exceed NOM-114-SCFI-2016 standard.

ITEM	2412
CAPACITY	26,455 lb
MINIMUM HEIGHT	8-57/64"
MAXIMUM HEIGHT	17-3/4"
Ø	1
AVAILABLE	✓



Wide and solid base that provides excellent support and stability when operating.



Three parts galvanized telescopic handle.



AUTOMOTIVE AND HYDRAULIC TOOLS

**HYDRAULIC BOTTLE JACK**



Rotating handle with housing for the lever.



Hydraulic stroke limitation.



Safety valve against overload.



Vertical and horizontal use.

- Ideal for lifting cars and trucks.
- Equipped with a lowering control device.
- Wide and solid base provides excellent support and stability during operation.
- Three-piece galvanized telescopic handle.
- Exceed NOM-114-SCFI-2016 standard.

ITEM	2450
CAPACITY	110,231 lb
MINIMUM HEIGHT	10-15/64"
MAXIMUM HEIGHT	15-3/4"
Ø	1
AVAILABLE	✓



Wide and solid base that provides excellent support and stability when operating.



Three parts galvanized telescopic handle.

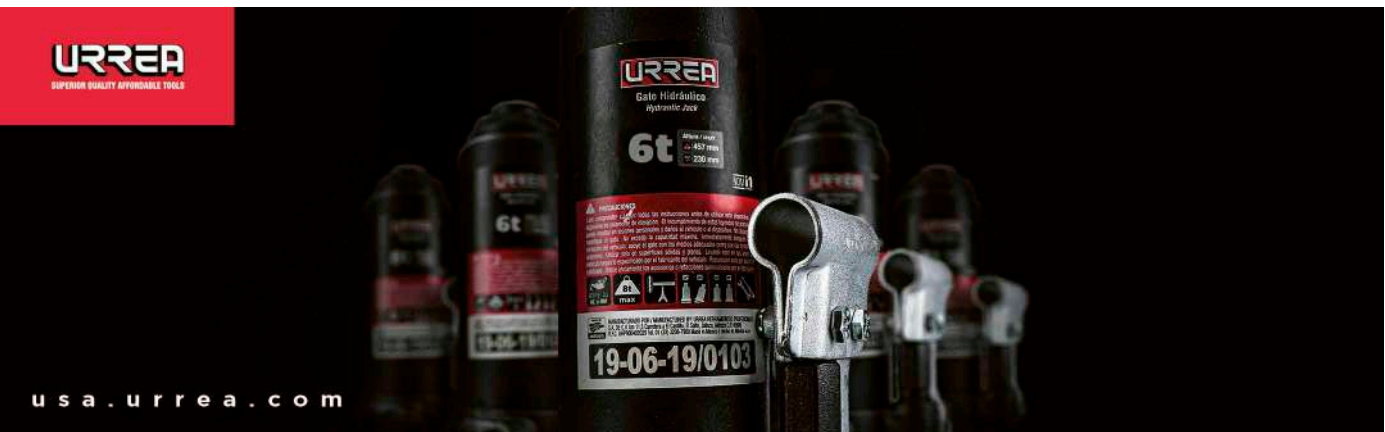

usa.urrea.com

## HYDRAULIC BOTTLE JACKS

### HYDRAULIC BOTTLE JACK



**2 T**  
MAX. CAPACITY



Safety valve against overload.



Hydraulic stroke limitation.



- Ideal for lifting cars.
- Piston made of steel for greater strength.
- Galvanized tubular handle with plastisol grip.
- Exceed NOM-114-SCFI-2016 standard.

ITEM	2402N
CAPACITY	4,409 lb
MINIMUM HEIGHT	7.1"
MAXIMUM HEIGHT	13.8"
☐	1
AVAILABLE	✓



### HYDRAULIC BOTTLE JACK



**4 T**  
MAX. CAPACITY



Safety valve against overload.



Hydraulic stroke limitation.



- Ideal for lifting cars.
- Piston made of steel for greater strength.
- Galvanized tubular handle with plastisol grip.
- Exceed NOM-114-SCFI-2016 standard.

ITEM	2404N
CAPACITY	8,818 lb
MINIMUM HEIGHT	7.6"
MAXIMUM HEIGHT	15.1"
☐	1
AVAILABLE	✓



### HYDRAULIC BOTTLE JACK



**6 T**  
MAX. CAPACITY



Safety valve against overload.



Hydraulic stroke limitation.



- Ideal for lifting cars.
- Piston made of steel for greater strength.
- Galvanized tubular handle with plastisol grip.
- Exceed NOM-114-SCFI-2016 standard.

ITEM	2406N
CAPACITY	13,227 lb
MINIMUM HEIGHT	8.5"
MAXIMUM HEIGHT	17.3"
☐	1
AVAILABLE	✓



### HYDRAULIC BOTTLE JACK



**8 T**  
MAX. CAPACITY



Safety valve against overload.



Hydraulic stroke limitation.

AVAILABLE



- Ideal for lifting cars.
- Piston made of steel for greater strength.
- Galvanized tubular handle with plastisol grip.
- Exceed NOM-114-SCFI-2016 standard.

ITEM	2408N
CAPACITY	17,636 lb
MINIMUM HEIGHT	9"
MAXIMUM HEIGHT	18.7"
☐	1
AVAILABLE	On Request



AUTOMOTIVE AND HYDRAULIC TOOLS

**HYDRAULIC BOTTLE JACKS**

**HYDRAULIC BOTTLE JACK**



**12 T**  
MAX. CAPACITY



Safety valve against overload.



Hydraulic stroke limitation.

- Ideal for lifting cars.
- Piston made of steel for greater strength.
- Galvanized tubular handle with plastisol grip.
- Exceed NOM-114-SCFI-2016 standard.

ITEM	2412N
CAPACITY	26,455 lb
MINIMUM HEIGHT	9"
MAXIMUM HEIGHT	18.6"
☞	1
AVAILABLE	On Request



URREA



**HYDRAULIC BOTTLE JACK**



**20 T**  
MAX. CAPACITY



Safety valve against overload.



Hydraulic stroke limitation.

- Ideal for lifting cars.
- Piston made of steel for greater strength.
- Galvanized tubular handle with plastisol grip.
- Exceed NOM-114-SCFI-2016 standard.

ITEM	2420N
CAPACITY	44,092 lb
MINIMUM HEIGHT	9.5"
MAXIMUM HEIGHT	17.6"
☞	1
AVAILABLE	✓



URREA



**RACK WITH 10 BOTTLE JACKS**

**10**  
PIECES



URREA



ITEM	DESCRIPTION	☞	AVAILABLE
DB1402	Rack with 10 bottle jacks	1	✓

**HYDROPNEUMATIC BOTTLE JACK**



**20 T**  
MAX. CAPACITY

- Body made of steel.
- Complies with NOM-114-SCFI-2016 standard.
- Pressure: 90–175 PSI.

ITEM	GBH20
CAPACITY	20 t
MINIMUM HEIGHT	10.5"
MAXIMUM HEIGHT	20.2"
HYDRAULIC STROKE	6.5"
SCREWS TROKE	3.2"
☞	1
AVAILABLE	On Request



SURTEK



**HYDRAULIC BOTTLE JACK**



**2 T**  
MAX. CAPACITY

- Ideal for lifting cars.
- Body made of steel.
- Tubular handle with electrostatic paint finish.
- Comply with NOM-114-SCFI-2016 standard.

ITEM	GBS2
CAPACITY	2 t (4,409 lb)
MINIMUM HEIGHT	6.2"
MAXIMUM HEIGHT	12.5"
HYDRAULIC STROKE	3.5"
HEIGHT EXTENSION	2.3"
WEIGHT	4.9 lb
☞	1
AVAILABLE	✓



SURTEK



AUTOMOTIVE AND HYDRAULIC TOOLS

## HYDRAULIC BOTTLE JACKS

### HYDRAULIC BOTTLE JACK



- Ideal for lifting cars.
- Body made of steel.
- Tubular handle with electrostatic paint finish.
- Comply with NOM-114-SCFI-2016 standard.

ITEM	GBS4
CAPACITY	4 t (8,818 lb)
MINIMUM HEIGHT	7"
MAXIMUM HEIGHT	14.2"
HYDRAULIC STROKE	4.3"
HEIGHT EXTENSION	2.3"
WEIGHT	6,8 lb
☞	1
AVAILABLE	On Request



### HYDRAULIC BOTTLE JACK



- Ideal for lifting cars.
- Body made of steel.
- Tubular handle with electrostatic paint finish.
- Comply with NOM-114-SCFI-2016 standard.

ITEM	GBS6
CAPACITY	6 t (13,228 lb)
MINIMUM HEIGHT	7.8"
MAXIMUM HEIGHT	15.5"
HYDRAULIC STROKE	5"
HEIGHT EXTENSION	2.3"
WEIGHT	9 lb
☞	1
AVAILABLE	On Request



### HYDRAULIC BOTTLE JACK



- Ideal for lifting cars.
- Body made of steel.
- Tubular handle with electrostatic paint finish.
- Comply with NOM-114-SCFI-2016 standard.

ITEM	GBS8
CAPACITY	8 t (17,637 lb)
MINIMUM HEIGHT	7.9"
MAXIMUM HEIGHT	15.7"
HYDRAULIC STROKE	5"
HEIGHT EXTENSION	2.3"
WEIGHT	10,8 lb
☞	1
AVAILABLE	On Request



### HYDRAULIC BOTTLE JACK



- Ideal for lifting cars.
- Body made of steel.
- Tubular handle with electrostatic paint finish.
- Comply with NOM-114-SCFI-2016 standard.

ITEM	GBS12
CAPACITY	12 t (26,455 lb)
MINIMUM HEIGHT	8.8"
MAXIMUM HEIGHT	16.3"
HYDRAULIC STROKE	5"
HEIGHT EXTENSION	2.3"
WEIGHT	14,3 lb
☞	1
AVAILABLE	On Request



AUTOMOTIVE AND HYDRAULIC TOOLS



**HYDRAULIC BOTTLE JACKS**

**HYDRAULIC BOTTLE JACK**



- Ideal for lifting cars.
- Body made of steel.
- Tubular handle with electrostatic paint finish.
- Comply with NOM-114-SCFI-2016 standard.

ITEM	GBS16
CAPACITY	16 t (35,274 lb)
MINIMUM HEIGHT	8.8"
MAXIMUM HEIGHT	17.4"
HYDRAULIC STROKE	5.5"
HEIGHT EXTENSION	2.3"
WEIGHT	16,8 lb
☞	1
AVAILABLE	On Request



**HYDRAULIC BOTTLE JACK**



- Ideal for lifting cars.
- Body made of steel.
- Tubular handle with electrostatic paint finish.
- Comply with NOM-114-SCFI-2016 standard.

ITEM	GBS20
CAPACITY	20 t (44,092 lb)
MINIMUM HEIGHT	9.4"
MAXIMUM HEIGHT	17.6"
HYDRAULIC STROKE	5.6"
HEIGHT EXTENSION	2.3"
WEIGHT	22,5 lb
☞	1
AVAILABLE	On Request



VIDEO



**HYDRAULIC BOTTLE JACK**



- Ideal for lifting cars.
- Body made of steel.
- Tubular handle with electrostatic paint finish.
- Comply with NOM-114-SCFI-2016 standard.

ITEM	GBS32
CAPACITY	32 t (70,548 lb)
MINIMUM HEIGHT	11.2"
MAXIMUM HEIGHT	18.3"
HYDRAULIC STROKE	7"
HEIGHT EXTENSION	/
WEIGHT	29,1 lb
☞	1
AVAILABLE	On Request



**HYDRAULIC BOTTLE JACK**



- Ideal for lifting cars.
- Body made of steel.
- Tubular handle with electrostatic paint finish.
- Comply with NOM-114-SCFI-2016 standard.

ITEM	GBS50
CAPACITY	50 t (110,231 lb)
MINIMUM HEIGHT	11.8"
MAXIMUM HEIGHT	18.8"
HYDRAULIC STROKE	7"
HEIGHT EXTENSION	/
WEIGHT	66,1
☞	1
AVAILABLE	On Request



VIDEO



AUTOMOTIVE AND HYDRAULIC TOOLS

## TRANSMISSION JACKS

### HYDRAULIC TRANSMISSION JACKS, TREATED AND POLISHED PISTON



NEW

- Facilitates the mounting and dismounting of transmissions, engines, and gearboxes.
- Includes chain for securing the load.
- Piston with polyurethane "Y"-type sealing ring and backup ring prevents slow load descent and oil leakage.

ITEM	137110	137111
CAPACITY	1,102 lb	2,204 lb
MINIMUM HEIGHT	8.5"	8.2"
MAXIMUM HEIGHT	23"	30"
WEIGHT	84.4 lb	158 lb
⊞	1	1
AVAILABLE	On Request	On Request

### TRANSMISSION JACK ADAPTER



**440 LB**  
MAX. CAPACITY



NEW

- Allows converting a standard floor jack into a transmission jack.
- Tilting saddle for better positioning and adjustment of the transmission.
- Four adjustable arms ensure secure fastening.
- Safety chain included for added stability.
- Ideal for mounting or removing transmissions, differentials, and transfer cases.



ITEM	CAPACITY	⊞	AVAILABLE
137112	440 lb	1	On Request

## MOTORCYCLE HYDRAULIC JACK

### MOTORCYCLE HYDRAULIC JACK



**1 100 LB**  
MAX. CAPACITY



NEW

- Manufactured from steel.
- Facilitates motorcycle repair and maintenance with a hydraulic lift that allows raising the vehicle.

ITEM	137120
CAPACITY	1,100lb
MINIMUM HEIGHT	4.4"
MAXIMUM HEIGHT	17"
WEIGHT	83 lb
⊞	1
AVAILABLE	On Request

HYDRAULIC TRANSMISSION JACKS,  
TREATED AND POLISHED PISTON

usa.urrea.com

## CRANES

### FOLDABLE SHOP CRANE



Safety valve against overload.



Hydraulic stroke limitation.



Lowering control device.



**1 t**  
MAX. CAPACITY

**2 SWIVEL**  
CASTERS

Total load capacity	
Position	Capacity
1	2,205 lb
2	1,984 lb
3	1,764 lb
4	1,543 lb

- Built with high grade steel and made under strict quality standards.
- Lowering control system detects when crane is holding load, so when operation is completed and risk disappears, lowering speed without load is accelerated.
- Both models have foldable legs for convenient storage.

ITEM	HEIGHT (A)	BOOM EXTENSION (R)	BASE LENGTH (C)	BASE THICKNESS (E)	INTERNAL WIDTH (D)	REAR WIDTH (G)	FOLDED LENGTH (F)	FOLDED SIZE	⊞	AVAILABLE
2490A	62-13/64"	63-3/8" - 51-3/16"	60"	4-13/32"	38-3/16"	11-13/16"	21-1/4"	24-7/32"	1	On Request

**CRANES**

**FOLDABLE HYDRAULIC ENGINE CRANES WITH "V"-SHAPED LEGS**



Safety valve against overloads.



Hydraulic travel limiter.



Control handle for lifting and lowering.



Adjustable arm for different load capacities depending on the model.

URREA



NEW

**1 T**  
MAX. CAPACITY

PLHV1 Total load capacity	
Position	Capacity
1	551 lb
2	1,102 lb
3	1,653 lb
4	2,204 lb

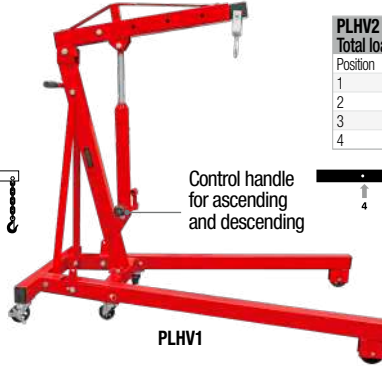

PLHV1

**2 T**  
MAX. CAPACITY

PLHV2 Total load capacity	
Position	Capacity
1	1,102 lb
2	2,204 lb
3	3,306 lb
4	4,409 lb



PLHV2

Control handle for ascending and descending

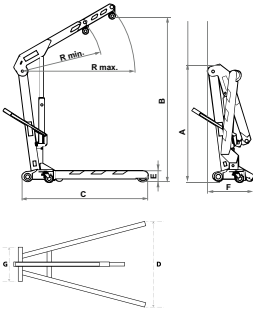

- Constructed from high-grade steel.
- Ideal for lifting various types of loads such as engines, steel drums, sacks, wooden boxes, etc.
- Lead-free paint finish applied through a chemical bath process to ensure a durable coating and help prevent rust.
- Models feature foldable legs for easy storage.
- Treated and polished piston for wear resistance.

ITEM	HEIGHT (A)	BOOM EXTENSION (R)	BASE LENGHT (C)	BASE THICKNESS (E)	INTERNAL WIDTH (D)	EXTERNAL WIDTH	REAR WIDTH (G)	FOLDED LENGTH (F)	⊞	AVAILABLE
PLHV1	60.0"	35.4" - 46.1"	59.4"	7.2"	36.6"	29.5"	15.7"	16.1"	1	On Request
PLHV2	64.2"	37.4" - 57.5"	67"	7.8"	39.4"	31.9"	17.7"	19.3"	1	On Request

**FOLDABLE HYDRO-PNEUMATIC CRANE**



URREA



NEW

**2 T**  
MAX. CAPACITY

**6 SWIVEL CASTERS**

Total load capacity	
Position	Capacity
1	1,102 lb
2	2,204 lb
3	3,306 lb
4	4,409 lb

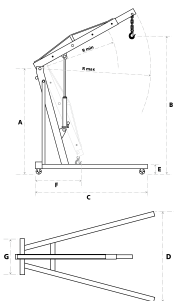

- Body and arm made of Q235 steel.
- Lead-free paint finish ensures a durable coating and helps prevent rust.
- Two operation modes: manual and pneumatic.
- Foldable legs for easy storage.
- Treated and polished piston for wear resistance.

ITEM	HEIGHT (A)	BOOM EXTENSION (R)	BASE LENGHT (C)	BASE THICKNESS (E)	INTERNAL WIDTH (D)	EXTERNAL WIDTH	REAR WIDTH (G)	FOLDED LENGTH (F)	⊞	AVAILABLE
2492	54.5"	39.4" - 60.6"	68.3"	7.1"	36.2"	41.1"	41.1"	26.0" - 35.0"	1	On Request

## CRANES

### FOLDABLE HYDRAULIC ENGINE CRANES WITH ADJUSTABLE LIFTING POSITION



NEW



**1 T**  
MAX. CAPACITY

**2 SWIVEL**  
CASTERS

Total load capacity	
Position	Capacity
1	551 lb
2	1,102 lb
3	1,653 lb
4	2,204 lb



**2 T**  
MAX. CAPACITY

**6 SWIVEL**  
CASTERS

Total load capacity	
Position	Capacity
1	1,102 lb
2	2,204 lb
3	3,306 lb
4	4,409 lb

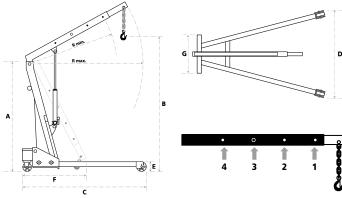

- Constructed from high-grade steel.
- Ideal for lifting various types of loads such as engines, steel drums, sacks, wooden boxes, etc.
- Made from high-grade steel and built under strict quality and durability standards.
- Electrostatic paint finish provides corrosion protection.
- Models feature foldable legs for easy storage.



ITEM	HEIGHT (A)	BOOM EXTENSION (R)	BASE LENGTH (C)	BASE THICKNESS (E)	INTERNAL WIDTH (D)	EXTERNAL WIDTH	REAR WIDTH (G)	FOLDED LENGTH (F)	⊞	AVAILABLE
2493	53.9"	34.3 - 44.9"	49.2"	6.9"	35.0"	38.6"	26.8"	13.4"	1	On Request
2494	54.5"	39.4 - 60.6"	68.3"	7.1"	36.2"	41.1"	31.5"	26.0 - 35.0"	1	On Request

### HYDRAULIC SHOP CRANE WITH EXTENSIONS



**2 T**  
MAX. CAPACITY

**2 SWIVEL**  
CASTERS

Total load capacity			
Position	Capacity	Extension length	Maximum height
1	4,409 lb	41-5/32"	72-1/32"
2	3,307 lb	48-7/32"	77-31/32"
3	2,205 lb	55-5/16"	83-15/32"
4	1,102 lb	62-13/32"	89-3/8"

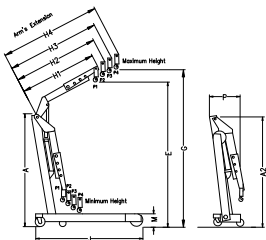

- Extensible arm with screw to perform its positioning.
- Lateral and frontal extensions for greater stability.
- Resistant for its design and construction.



ITEM	CAPACITY	HEIGHT (A)	ARM EXTENSION (H)	DISTANCE BETWEEN POSITIONS (I)	BASE LENGTH (J)	BASE WIDTH (M)	INTERNAL WIDTH (K)	EXTERNAL WIDTH (L)	BACK WIDTH (S)	FOLDABLE LENGTH (P)	FOLDABLE HEIGHT (A2)	⊞	AVAILABLE
PLUE2	2t (4,409 lb)	135.5	37-13/32"	7"	57"	6-7/8"	23-5/8"	28-11/32"	36-13/32"	19-11/16"	56-9/32"	1	On Request

**HYDRAULIC SHOP PRESS**

**HYDRAULIC SHOP PRESS**

**URREA**  
TOOLS FOR SPECIALISTS



**50 T**  
MAX. CAPACITY



Hydraulic stroke limitation.



Piston with automatic return.



Safety valve against overload.

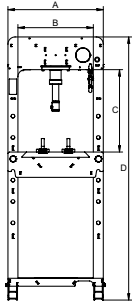

- Manometer integrated in the body.
- Mobile tray to store parts, tools, liquids, etc.
- Includes 2 "V" supports with clamping guide and extraction hole.
- Adjustable work table in different heights.
- Useful tray in the base.
- Mandrel holder (does not include mandrels).

ITEM	CAPACITY	WEIGHT	WORKING RANGE	HYDRAULIC ROUTE	A	B	C (MAX.)	D	☐	AVAILABLE
2472	110,231 lb	320 lb	2-9/32" - 30-1/8"	7-11/16"	26-3/8"	20-7/8"	30-5/32"	72-53/64"	1	On Request

**HYDRAULIC SHOP PRESSES, WITH PISTON**

**SURTEK**  
TOOLS FOR SPECIALISTS



**20 T**  
MAX. CAPACITY

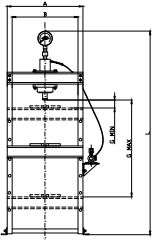

- Reinforced structure of type "C" joist.
- Piston with automatic recoil.
- Pressure gauge manometer.
- 3 mm thick steel body.
- Adjustable worktable to different heights.
- Base with holes for fixing to the ground.
- Reversible telescopic piston.

ITEM	CAPACITY		WORKING RANGE (G)	HYDRAULIC STROKE (R)	BED WIDTH (A)	EXTERNAL WIDTH (B)	☐	AVAILABLE
	TON	LB						
PHIP20	20 t	44,092	0 - 38-3/16"	10-1/4"	29-1/8"	32-1/2"	1	On Request

**HYDRAULIC SHOP PRESSES, WITH BOTTLE JACK**

**SURTEK**  
TOOLS FOR SPECIALISTS



**30 T**  
MAX. CAPACITY

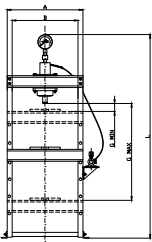

- Reinforced structure type "C" joist.
- Steel crossbar that prevents the frame from opening under load.
- Pressure exerted by hydraulic jack.
- Overload valve.
- 3 mm thick steel body.
- Adjustable worktable to different heights.
- Base with holes for fixing to the ground.

ITEM	CAPACITY		WORKING RANGE (G)	HYDRAULIC STROKE (R)	BED WIDTH (A)	EXTERNAL WIDTH (B)	☐	AVAILABLE
	TON	LB						
PHI30	30 t	66,139	0 - 37-13/16"	5-1/2"	25-3/16"	25-3/16"	1	On Request

## JACK STANDS

### CAST IRON JACK STANDS FOR AUTOMOBILES



- One-piece body construction.
- Coated with high-grade enamel.
- Cast ratchet post mechanism.
- Wide-base legs to resist sinking.

**IMPORTANT: For your safety, do not use hydraulic jacks if you plan to remain under the vehicle for an extended period; use jack stands for this purpose.**

ITEM	PAIR CAPACITY	MINIMUM HEIGHT	MAXIMUM HEIGHT	☞	AVAILABLE
194	3 t	11.8"	17.0"	1	On Request
195	6 t	15.4"	24.0"	1	On Request
196	12 t	17.3"	28.4"	1	On Request



196



### STEEL JACK STANDS FOR AUTOMOBILES



- Steel body.
- Coated with electrostatic paint that protects against corrosion.
- Cast ratchet post mechanism.

**IMPORTANT: For your safety, do not use hydraulic jacks if you plan to remain under the vehicle for an extended period; use jack stands for this purpose.**

ITEM	PAIR CAPACITY	MINIMUM HEIGHT	MAXIMUM HEIGHT	☞	AVAILABLE
TOR2	2 t	10.4"	11.8"	1	On Request
137052	3 t	11.2"	15.9"	1	On Request
137053	6 t	14.7"	23.2"	1	On Request



137052



NEW

### STAMPED STEEL CAR RAMPS



- Steel body.
- Powder-coated finish protects against corrosion.
- Non-slip design ensures safety during ascent.
- Maximum tire width: 21 cm.
- Combined (pair) capacity: 2 tons.

ITEM	DESCRIPTION	CAPACITY	DIMENSIONS	PROFILE	☞	AVAILABLE
RAMT2	Stamped steel car ramps	2 t	37.0" x 10.6" x 11"	High profile	1	On Request



NEW

### PLASTIC CAR RAMPS



- Polypropylene body.
- Non-slip design ensures safety during ascent.
- Combined (pair) capacity: 4 tons.

ITEM	DESCRIPTION	CAPACITY	DIMENSIONS	PROFILE	☞	AVAILABLE
RAMP4	Plastic car ramps	4 t	27.6" x 7.9" x 27.6"	Low profile	1	On Request

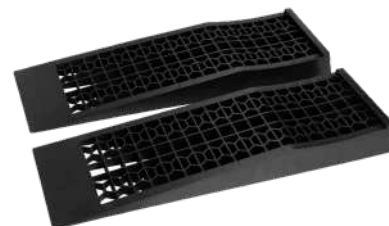

NEW



# GREASE, GUNS, OIL PUMPS AND OTHER FLUID DISPENSERS

# 14



CLASS	TYPER	PAGE	BRAND	
			URREA	SURTEK
Lubricant handling equipment	Oilers	414	•	•
	Fluid extractor pumps	416	•	•
	Lever-action fluid extractor	418	•	
	Bucket grease pump	422	•	
	Fluid transfer pumps	418	•	
	Anti splash funnels	419	•	
	Barrel faucet	419	•	
	Grease guns	419	•	•
	Barrel wrench	424	•	
	Oil control guns	424	•	

[usa.urrea.com](http://usa.urrea.com)

We are constantly improving our products, that is why the information, characteristics and availability of them can change without prior notice.

## OILERS

### FLEXIBLE OILERS



2265



2264

- Metal container with electrostatic paint for corrosion resistance.
- Reinforced steel pump system with double valve for increased output.

ITEM	CAPACITY		AVAILABILITY
2265	946 ml	32 oz	1 On Request

ITEM	CAPACITY		AVAILABILITY
2264	473 ml	16 oz	1 On Request



### FLEXIBLE SPOUT OILERS



2267



2266

- Metal container with electrostatic paint for corrosion resistance.
- Reinforced steel pump system with double valve for increased output.

ITEM	CAPACITY		AVAILABILITY
2267	473 ml	16 oz	1 On Request

ITEM	CAPACITY		AVAILABILITY
2266	177 ml	6 oz	1 On Request



### STRAIGHT OILERS



2261



2260

- Metal container with electrostatic paint for corrosion resistance.
- Reinforced steel pump system with double valve for increased output.
- 30° fixed rigid nozzle.

ITEM	CAPACITY		NOZZLE ANGLE	AVAILABILITY
2261	946 ml	32 oz	30°	1 On Request

ITEM	CAPACITY		NOZZLE ANGLE	AVAILABILITY
2260	473 ml	16 oz	30°	1 On Request



### FLEXIBLE OILERS



NEW



137212



137215

- Metal container with integrated pump

ITEM	CAPACITY		AVAILABILITY
137212	177 ml	6 oz	10 On Request
137213	296 ml	10 oz	10 On Request

- Metal container with integrated pump

ITEM	CAPACITY		AVAILABILITY
137214	473 ml	16 oz	10 On Request
137215	680 ml	23 oz	6 On Request

BULK



## PUMP GUIDE SELECTION

	SWIVELS					ELECTRICS		VERTICAL			LEVER			
TRADEMARK	URREA	URREA	URREA	SURTEK	SURTEK	URREA	URREA	URREA	URREA	URREA	SURTEK	URREA	URREA	SURTEK
ITEM	2363F	2363RQ	2363R	137222	137223	2363E	2363S	2363VT	2363VQ	2363V	137224	2363W	2363	137225
LEVEL USE														
FLOW	2.64 gal / 20 turns	1.30 gal / 20 turns	1.30 gal / 20 turns	0.06 gal / turn	0.8 L / turn	4.86 gal / min	20 oz / stroke	14 oz / stroke	14 oz / stroke	26 oz / stroke	0.8 L / turn	19.907 oz / stroke	8.5 to 10 oz / stroke	0.8 L / stroke
FOR USE WITH														
Light oils	✓	✓	✓			✓	✓					✓	✓	
Thick oils	✓		✓											
Diesel	✓		✓	✓	✓	✓	✓				✓		✓	
Gasoline	✓			✓										
Kerosene	✓		✓		✓	✓	✓				✓		✓	
Acetone				✓			✓	✓			✓			
Antifreeze		✓				✓		✓	✓			✓		
Herbicides						✓		✓				✓		
Acids		✓		✓										
Lacquers										✓				
Thinner							✓			✓				
Glycerin		✓						✓	✓		✓			
Water								✓						
Water based fluids		✓				✓						✓		
Detergents		✓				✓		✓	✓			✓		
Ammonia		✓					✓	✓				✓		
Citric acid		✓												
Oxygenated whater		✓												
Naphthalene		✓												
Solvents							✓							
Sulfuric acid		✓												
Biodiese														
(DEF) Diesel exhaust fluid						✓	✓							
Naphta							✓							
Benzen							✓				✓			
Adblue							✓					✓		
Photographic chemicals							✓							
Liquidos base petróleo									✓					
Pretroleum based liquids								✓						
Medium base pretroleum fluids										✓				
Petroleum				✓	✓						✓			
Lacquer thinners								✓						
Brake cleaner								✓						
Alcohol				✓							✓			
Xylene				✓										
Ethanol											✓			
Methanol											✓			
Propanol											✓			
Oil					✓									✓

## OIL EXTRACTOR PUMPS

### OIL ROTARY PUMP BOOSTER



- Recommended for lubricating oils up to SAE 30.
- Do not use with: corrosive liquids, solvents, acids or alkaline liquids.



ITEM	SUPPLY	AVAILABLE
2363F	2.64 gal/ 20 turns	1 On Request

### OIL ROTARY BARREL PUMP FOR CHEMICALS



- Fits 2" threads on 205 liter drums.
- Quick and easy assembly.
- Resistance to chemical products and solvents.



ITEM	SUPPLY	AVAILABLE
2363RQ	1.3 gal/ 20 turns	1 On Request

### OIL ROTARY BARREL PUMP FOR LUBRICANTS



- For: motor oil, hydraulic oil and other low and medium viscosity non-corrosive fluids.
- Dual directional operation.



ITEM	SUPPLY	AVAILABLE
2363R	1.3 gal/ 20 turns	1 On Request

### OIL ROTARY BARREL PUMP FOR CHEMICALS



- Quick and easy assembly.
  - Pump and body made of PPS plastic.
- Follow fluid compatibility chart.**



ITEM	SUPPLY	AVAILABLE
137222	8.5 oz/turn (0.25 L / turn)	1 On Request

### ROTARY BARREL PUMP



- Quick and easy assembly.
  - Pump and body made of PPS plastic.
- Follow fluid compatibility chart.**



ITEM	SUPPLY	AVAILABLE
137223	10 oz/turn (0.3 L / turn)	1 On Request

## ELECTRIC OIL EXTRACTOR PUMPS

### ELECTRIC DRUM PUMP



- 12V DC motor.
- Compatible with: diesel, kerosene, biodiesel, DEF, water-based fluids, antifreeze, detergents, light oils (up to 100 cSt), pesticides, and herbicides.



ITEM	SUPPLY	AVAILABLE
2363E	4.86 gal/min	1 ✓

**VERTICAL OIL EXTRACTOR PUMPS**

**VERTICAL LIFT STAINLESS STEEL PUMP**



- Light oils with maximum SAE 40 viscosity.
- Do not use with heavy oils.



ITEM	SUPPLY	AVAILABILITY
2363S	20 oz/stroke	1 On Request

**VERTICAL LIFT PUMP FOR CHEMICALS**



- Do not use: strong acids, hairspray, acetone, gasoline, etc.



ITEM	SUPPLY	AVAILABILITY
2363VQ	14 oz/stroke	1 On Request

**VERTICAL LIFT BARREL PUMP FOR LUBRICANTS**



- Fits 2" threads on 205-liter drums.
- Body and tube made of steel.

**Follow usage chart for proper operation.**



ITEM	SUPPLY	AVAILABILITY
137224	10.1 oz / stroke	1 On Request

**VERTICAL LIFT PUMP FOR THINNERS**



- Recommended uses: lacquer thinners, acetone, antifreeze, brake cleaner, detergents, glycerin, water, herbicides, petroleum base media, etc.
- Do not use: strong acids, gasoline, chlorine, etc.



ITEM	SUPPLY	AVAILABILITY
2363VT	14 oz/stroke	1 On Request

**VERTICAL LIFT BARREL PUMP FOR LUBRICANTS**



- Not recommended for gasoline and corrosive liquids.



ITEM	SUPPLY	AVAILABILITY
2363V	26 oz/stroke	1 On Request

**LEVER OIL EXTRACTOR PUMPS**

**PLASTIC LEVER BARREL PUMP**



- 2" incorporated adapter.
- Water-based fluids, soaps, windscreen wiper, lubricants, herbicides, urea, DEF, etc.



ITEM	SUPPLY	AVAILABILITY
2363W	16.907 oz / stroke	1 On Request

GREASE GUNS OIL PUMPS AND OTHER FLUID DISPENSERS

## LEVER OIL EXTRACTOR PUMPS

### BARREL PUMP



- Hand-operated pump.
- For drums or barrels.
- Hand-operated pump.
- Efficiently pumps under any type of weather.



ITEM	SUPPLY	AVAILABLE
2363	25-50 lb / 5 gal	1 ✓

### BARREL PUMP



NEW



- Fits 2" threads on 205-liter drums.
  - Body and tube made of steel.
- Follow usage chart for proper operation.**



ITEM	SUPPLY	AVAILABLE
137225	25-50 lb / 5 gal	1 On Request

## LEVER ACTION OIL EXTRACTOR PUMPS

### LEVER ACTION BUCKET OIL EXTRACTOR PUMPS



- Includes 1.2m/4ft PVC hose.
- For oils of low, medium and high viscosity.



ITEM	BUCKET CAPACITY	SUPPLY	AVAILABLE
23624	4.22 gal / 16 L	4.5 oz/stroke	1 On Request

### BUCKET OIL EXTRACTOR PUMP



- Delivers: 2.14 Oz/stroke.
- Fits on 5 gallon buckets.



ITEM	DIAMETER	BUCKET SIZE	AVAILABLE
2362	12"	25-50 lb / 5 gal	1 On Request

## BUCKET OIL EXTRACTOR PUMP

### BUCKET OIL EXTRACTOR PUMP



- For use with 11–22 kg or 19 L grease buckets.
- Made of alloyed aluminum that offers great strength and durability.
- Nozzle with nipple for refilling grease guns.



ITEM	DIAMETER	SUPPLY	AVAILABLE
2361	12"	25-50 lb / 5 gal	1 On Request

## TRANSFER PUMP

### DIAPHRAGM TRANSFER PUMP

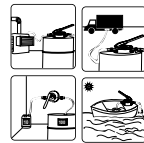

- 2 in 1 pump.
- Fixed or portable: to transfer liquids from one tank to another.
- Drainage pump: to drain flooded areas.
- With option to be fixed on walls or columns.
- For water, sea water, diesel, biodiesel, kerosene, gasoline, mineral oil or synthetic, antifreeze, emulsions or liquids with small particles suspended.
- Not recommended for ammonia or food fluids.



ITEM	SUPPLY	AVAILABLE
23626	4.4 gal per minute	1 On Request

GREASE, GUNS, OIL PUMPS AND OTHER FLUID DISPENSERS

## TRANSFER PUMPS

### BRASS TRANSFER PUMP



- Includes suction and discharge hose.
- Brass housing and neoprene caps easy to clean.
- Resistant to corrosive and non-corrosive liquids.
- For engine, hydraulic, steering, transmission oils, antifreeze, brake fluids, diesel and water.
- Ideal for transferring fluids from one container to another without draining.



ITEM	BUCKET CAPACITY	TOTAL LENGTH	CYLINDER DIAMETER	⊞	AVAILABLE
23627	3,38 oz/100 ml	10-1/2"	1-1/4"	1	On Request

## ANTI SPLASH FUNNELS

### ANTI-SPLASH FUNNELS



EMB1

EMB2

- Made of polypropylene.
- Designed with special contours in the body for easy handling.
- Anti splash and spill proof with curved edges.
- Made in a translucent white for better vision of fluids.
- Has a dust cover.
- Flexible channel.
- Container has a fixed cap.

**BULK**

ITEM	CAPACITY	DIAMETER	EXTENTION LENGTH	⊞	AVAILABLE
EMB1	101.4 oz	9-29/64"	9-41/64"	1	On Request
EMB2	57.4 oz	8-5/64"	6-11/16"	1	On Request

## GREASE GUNS

### BATTERY OPERATED GREASE PUMP



**NICKEL-CADMIUM BATTERY**

**STANDARD 14 oz CARTRIDGE**



ITEM	2371
CAPACITY	14 oz / 400 g
SUPPLY	85 g/min
GREASE CONTAINER	500 cc
MAX. PRESSURE	6,000 psi
VOLTAGE	19.2V - 1.5 Ah
WEIGHT	7.4 kg (16.3 lb)
⊞	1
AVAILABLE	On Request

- 30' High pressure hose.
- Protective spring at both ends to prevent damage to the hose.
- Designed for use by mechanics, technicians, maintenance staff, farmers, etc. for everyday greasing and preventive maintenance jobs, from automotive, trucking and fleet to agriculture, construction & industry.



### SUCTION GUN



- Body and cover made of steel sheet.
- To transfer or suction non-corrosive liquids.
- Ideal for suctioning spilled oil mainly by machinery and industrial equipment.



ITEM	BUCKET CAPACITY	⊞	AVAILABLE
23625	16,9 oz/500 ml	1	On Request

## BARREL FAUCET

### BARREL FAUCET



**RESISTANCE TO CORROSION**



**PADLOCK HOLE FOR SAFETY**



- Fits plastic or metal 54-gallon drums.
- 2" screw.
- Made with polyethylene.
- Not to be used with gasoline, chemicals or solvents.
- Hole for paddlocks to prevent theft of fluids.



ITEM	SCREW	⊞	AVAILABLE
23641	2"	1	On Request

# 14 GREASE, GUNS, OIL PUMPS AND OTHER FLUID DISPENSERS

## GREASE GUNS

### TWO-HANDED GREASE GUNS

URREA



2369



2368

- Reinforced



2367

- General



2367M

- Compact
- Compact size ideal for easy storage.



ITEM	2369	2368	2367	2367M
CAPACITY	14 oz / 400 g	14 oz / 400 g	14 oz / 400 g	3 oz / 85 g
SUPPLY	1 gr. /cycle	1 gr. /cycle	1 gr. /cycle	-
GREASE PUMP FILLING	•	•	-	-
SUCTION FILLING	•	•	•	•
VARIABLE DRIVE HANDLE	•	•	-	-
MAX. PRESSURE	10,000 psi	8,000 psi	6,000 psi	6,000 psi
☒	1	1	1	1
AVAILABLE	On Request	On Request	On Request	On Request

### TWO-HANDED GREASE GUNS

SURTEK



136012



136011



136010

ITEM	136012	136011	136010
CAPACITY	14 oz / 400 g	14 oz / 400 g	14 oz / 400 g
DESCRIPTION	Aluminum head	With bleed valve	Includes rigid, angled and standard nozzle, Reed head
MAX. PRESSURE	10,000 psi	8,500 psi	6,500 psi
☒	1	1	1
AVAILABLE	On Request	On Request	On Request

## GREASE GUNS

### ONE-HANDED GREASE GUN



**URREA**  
INDUSTRIAL DUTY



- 4" rigid extension.
- Suction fill.



<b>ITEM</b>	<b>2366</b>
CAPACITY	14 oz / 397 g
SUPPLY	0.50 g / cycle
MAX. PRESSURE	5,000 psi
☐ AVAILABLE	1
	On Request

### ONE-HANDED MINI GREASE GUNS



**URREA**  
INDUSTRIAL DUTY



- Rigid extension.
- Suction fill.



<b>ITEM</b>	<b>2365</b>
CAPACITY	3 oz / 85 g
SUPPLY	0.40 g / cycle
MAX. PRESSURE	3,500 psi
☐ AVAILABLE	1
	On Request

### MINI GREASE GUN



**SURTEK**  
PROFESSIONAL USE



- Rigid extension.
- Suction fill.



<b>ITEM</b>	<b>136013</b>
CAPACITY	3 oz / 85 g
DESCRIPTION	Ideal for one-handed use in small places
MAX. PRESSURE	5,000 psi
☐ AVAILABLE	1
	On Request

### GREASE FITTINGS



**80**  
PIECES



**URREA**  
INDUSTRIAL DUTY



Angle	Total length	Pitch length	Pitch specifications	
90°	21.3	7.6	1/8" x 27 PTF SPL	10
45°	21.8	7.6	1/8" x 27 PTF SPL	10
Straight	16.8	7.1	1/8" x 27 PTF SPL	25
90°	19.3	5.1	1/4" x 28 SAE-LT	10
45°	20.8	5.1	1/4" x 28 SAE-LT	10
Straight	13.7	4.6	1/4" x 28 SAE-LT	5

- Corrosion resistant zinc coating.
- Steel ball check valve with hardened spring for maximum durability.



<b>ITEM</b>	<b>CONTENT</b>	☐ AVAILABLE
<b>23603</b>	80 pieces	1 On Request

### GREASE PUMP ACCESSORIES SET



**7**  
PIECES



**URREA**  
INDUSTRIAL DUTY



<b>ITEM</b>	<b>PIECES</b>	☐ AVAILABLE
<b>23600</b>	7	1 On Request

### GREASE PUMP COUPLER



**URREA**  
INDUSTRIAL DUTY



- Hexagonal nut for easy tightening.
- 4 jaw construction.
- Hydraulic coupler.



<b>ITEM</b>	<b>WORK PRESSURE</b>	☐ AVAILABLE
<b>23601</b>	6,000 psi / 413 bar	6 On Request

### NEEDLE NOZZLE FOR GREASE PUMP



**URREA**  
INDUSTRIAL DUTY



- Needle length: 1.1/2".
- Needle diameter: 5/32".
- Tip diameter: 3/64".
- Needle design allows operator to contact flush on hard to reach hydraulic type fittings in inaccessible areas.
- Used for dispensing a fine line of grease.



<b>ITEM</b>	<b>TO BE USED WITH</b>	☐ AVAILABLE
<b>23602</b>	2364, 2365, 2366, 2367, 2368 y 2369	6 On Request

### FLEXIBLE HOSE



**URREA**  
INDUSTRIAL DUTY



- Works at 3500 psi.
- Maximum pressure 11,300 psi.

<b>ITEM</b>	<b>DIAMETER</b>	<b>HOSE LENGTH</b>	☐ AVAILABLE
<b>23610</b>	5/16"	18" / 45.7 cm	1 On Request

### FLEXIBLE EXTENSION FOR GREASE GUN



**SURTEK**  
PROFESSIONAL USE



- For hand operated and power grease injectors.



<b>ITEM</b>	<b>SIZE</b>	☐ AVAILABLE
<b>136014</b>	12" / 30,5 cm	6 On Request

## BUCKET GREASE PUMP

### PNEUMATIC GREASE PUMPS



**66 LB**  
TOTAL LOAD CAPACITY



23629

**33 LB**  
TOTAL LOAD CAPACITY



23628

- Pressure booster “increases the air pressure”.
- Hole height of 6 feet (Parker®).
- For heavy duty lubrication use and preventative maintenance.
- Reinforced valve for high pressure.



ITEM	CAPACITY	MAX PRESSURE	AVAILABLE
23629	66,1 lb /30 kg	7,500 psi	1 On Request
23628	33 lb/15 kg	7,500 psi	1 On Request

### BUCKET GREASE PUMP WITH WHEELS



**44 LB**  
TOTAL LOAD CAPACITY



- Variable handle setting.
- Includes 2 m x 1/4" I.D. high pressure rubber hose.
- Air release valve for easily removing trapped air from grease.
- Recommended for grease NLGI 1, 2 & 3.



ITEM	CAPACITY	MAX PRESSURE	AVAILABLE
23622	44,1 lb/20 kg	4,000 psi	1 On Request

### FOOT OPERATED GREASE PUMP



**22 LB**  
TOTAL LOAD CAPACITY



- Drive pedal. Frees both hands of the user to raise their productivity.
- Recommended for grease NLGI 1, 2 & 3.
- Includes high pressure hose 2m x 1/4"
- Delivers 1oz/stroke.
- High pressure with pedal.



ITEM	BUCKET CAPACITY	MAX PRESSURE	AVAILABLE
23623	22 lb/10 kg	8,700 psi	1 On Request



**BUCKET GREASE PUMP**

**BUCKET GREASE PUMP**

**INDUSTRIAL DUTY**  
**22 LB**  
TOTAL LOAD CAPACITY



- Air release valve for easily removing trapped air from grease.
- Variable handle setting.
- Includes 2 m x 1/4" I.D. high pressure rubber hose.
- Recommended for grease NLGI 1, 2 & 3.



ITEM	CAPACITY	MAX PRESSURE	AVAILABILITY
23621	22 lb /10 kg	4,000 psi	1 On Request

**REINFORCED GREASE CONTROL VALVES**

**INDUSTRIAL DUTY**



**+ Two Z Rotary Connector pivots**



23616

- For super duty use grease and work maintenance preventive.

ITEM	MAX PRESSURE	AVAILABILITY
23616	8,000 psi	1 On Request

**Z TYPE ROTARY CONNECTOR**

**INDUSTRIAL DUTY**



**Two turning points**  
**360°**



ITEM	MAX PRESSURE	AVAILABILITY
23617	6,000 psi	1 On Request

**HIGH PRESSURE GREASE PUMP**

**INDUSTRIAL DUTY**  
**11 LB**  
TOTAL LOAD CAPACITY



- Supplies:
- High Pressure 0.45 g/shot at 10,000 psi.
- High volume 1.25 g/shot.
- Gun holder.
- ABS plastic container.
- Aluminum grease gun.
- Selector button
- High pressure/high volume.
- Metal handle for Transport.
- Foot operated system.



ITEM	BUCKET CAPACITY	MAX PRESSURE	AVAILABILITY
23620	11 lb /5 kg	10,000 psi	1 On Request

GREASE GUNS, OIL PUMPS AND OTHER FLUID DISPENSERS



23615



ITEM	MAX PRESSURE	AVAILABILITY
23615	10,000 psi	1 On Request



## BUCKET GREASE PUMP

### QUICK COUPLER FOR GREASE GUN



#### Mode of use

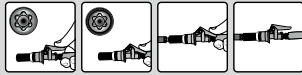

To connect, simply press the lever with thumb and slide jaw onto the equipment for lubricating.



- Manufactured in heat-treated steel with high resistance to wear and high pressures.
- Retractable jaw with lever.
- Working pressure 8000 psi.
- 1/8" NPT screw.
- Optimizes the delivery of grease. Ideal in agriculture, construction and industry, as well as automotive services and lubrication equipment.
- Allows free hands during lubrication tasks, once connected it does not need to be fastened.
- Reduces cost, due to its optimal delivery of leak-proof lubricant.



ITEM	WORK PRESSURE	AVAILABLE
23604	8,000 psi	1 On Request

## BARREL WRENCH



- To open most 2" and 3/4" barrel caps.
- Made of cast aluminum (LM25), hardened and tempered for strength.
- It does not spark, it is safe to use in flammable areas and fuel tanks.
- Due to its design, it reduces the force necessary to open the barrel, preventing injuries to the user.



ITEM	LENGTH	CAPACITY	AVAILABLE
23640	10-1/2"	2" y 3/4"	1 On Request

## OIL CONTROL GUNS

### OIL CONTROL GUNS



- Accuracy +/- 1%.
- Repeatability: 0.30%.
- Maximum working pressure: 1000 psi (70 BAR).
- Resolution: 0.10 liters or quarts a gallon.
- High accuracy and flow dispenser control.
- Recommended use: oils with viscosity up to SAE grade 140, diesel, kerosene, engine coolant (RTU).
- Do not use with: oil, gasoline, or water based fluids, etc.



- Accuracy +/- 1%.
- Repeatability: 0.20%.
- Maximum working pressure: 1000 psi (70 BAR).
- High accuracy and flow dispenser control.
- Flow can be measured in: liters, gallons, quarts a gallon, decileters and pints.



ITEM	23631	23632
TYPE	Mechanics	Digital
FLOW	1 to 30 LPM	1 to 30 LPM
PRECISION	+/- 1%.	+/- 1%.
REPEATABILITY	0.30%.	0.20%.
MAXIMUM WORKING PRESSURE	1,000 psi / 70 bar	1,000 psi / 70 bar
AVAILABLE	1 On Request	1 On Request



CLASS	TYPE	PAGE	BRAND	
			URREA	SURTEK
Diagnostic equipment	Multimeters	426	•	•
	Voltage testers	430	•	•
	Infrared thermometers	432	•	
Measuring equipment	Micrometers and vernier caliper	432	•	•
	Long measuring tapes	434	•	•
	Laser distance meters	436		•
	Measuring tapes	436	•	•
	Measuring wheels	439		•
Plotting equipment	Calipers	439	•	
	Squads	440	•	•
	Levels	441	•	•
	Laser levels	443	•	
	Chalk lines	444	•	•

usa.urrea.com

We are constantly improving our products, that is why the information, characteristics and availability of them can change without prior notice.

## MULTIMETERS SETS

### DIGITAL MULTIMETER SELECTION GUIDE

• Available function.  
• Unavailable function.

	DIGITAL MULTIMETERS						CLAMP DIGITAL MULTIMETERS			AUTOMOTIVE DIGITAL MULTIMETERS				
MODEL	UD179	UD85	UD112	UD18	UD12	MUL03	MUL02	UD337	UD334	UD333	UD88	UD226	MUL04	UD370
Usage		INDUSTRIAL DUTY				PROFESSIONAL USE		INDUSTRIAL DUTY			INDUSTRIAL DUTY		PROFESSIONAL USE	INDUSTRIAL DUTY
Electrical safety	CAT II 1000 V	CAT II 1000 V	CAT II 1000 V	CAT III 1000 V	CAT III 600 V	CAT III 1000 V	CAT III 600 V	CAT III 1000 V	CAT III 600 V	CAT III 600 V	CAT III 750 V	CAT III 600 V	CAT III 600 V	CAT III 750 V
Voltage CA	1000 V	600 mV/1000 V	1000 V	1000 V	600 V	4 V/750 V	200 mV/600 V	1000 V	400 mV/750 V	400 mV/750 V	750 V	600 V	750 V	750 V
Voltage CD	1000 V	600 mV/1000 V	1000 V	1000 V	600 V	400 mV/1000 V	200 V/600 V	1000 V	400 mV/1000 V	400 mV/1000 V	1000 V	600 V	1000 V	-
Current CA	10 A	10 A	10 A	-	-	10 A	-	1000 A	400 A	400 A	10 A	-	-	700 A
Current CD	10 A	10 A	10 A	-	-	10 A	10 A	1000 A	400 A	-	10 A	-	10 A	-
Resistance	40 MΩ	40 MΩ	40 MΩ	40 MΩ	200 Ω	40 MΩ	20 MΩ	40 MΩ	40 MΩ	40 MΩ	40 MΩ	40 MΩ	20 MΩ	-
Milivolts CA	400 mV	600 mA	400 mV	-	-	-	-	400 mV	400 mV	400 mV	-	-	-	-
Milivolts CD	400 mV	600 mA	400 mV	-	-	400 mV	200 mV	400 mV	400 mV	400 mV	400 mV	400 mV	200 mV	-
Microamps CD	400 μA 4000 μA	6000 μA	400 μA 4000 μA	600 μA 2000 μA	-	400 μA	200 μA	400 μA 2000 μA	-	400 μA 2000 μA	400 μA 4000 μA	-	-	-
Audible continuity indicator	•	•	•	•	•	•	•	•	•	•	•	•	•	-
Backlight	•	•	•	•	•	•	•	•	•	•	•	•	•	•
Temperature	-20° to 60 °C	-200° to 999 °C	-20° to 60 °C	-20° to 50 °C	-10° to 50 °C	-40° to 1000°C	-10° to 50 °C	-20° to 60°C	-20° to 60°C	0° to 45° C	-40° to 1370°C	-20° to 60 °C	-18° to 21°C	0° to 35°C
Auto/ Manual range	•	•	•	•	•	•	•	•	•	-	-	•	-	•
Data hold	-	•	-	•	-	•	•	•	•	•	•	-	•	•
Diode testing	•	•	•	•	-	•	•	•	•	•	-	-	•	-
Capacitance testing	100 μF	9999 μF	100 μF	9999 μF	-	400 μF	-	-	-	-	1000 μF	-	-	-
Auto power off function	•	•	•	•	•	•	•	•	•	•	•	•	•	•
LCD screen with count	4000 accounts	6000 accounts	4000 accounts	6000 accounts	2000 accounts	2000 accounts	2000 accounts	4000 accounts	4000 accounts	4000 accounts	4000 accounts	4000 accounts	4000 accounts	4000 accounts

DIAGNOSTIC AND MEASURING TOOLS

### ELECTRONIC TOOL SET

INDUSTRIAL DUTY

11  
PIECES



Content	Content
CPU17 Plastic tool box, 17 x 9 x 8" 1	204GR Plier, 4-3/16" diagonal cut 1
UD12 600 VCD/600 VCA Digital multimeter 1	282GR Plier, 4" needle 1
9503B Screwdriver, std 3/64 x 2-3/8 ESD 1	CAU50 Soldering iron, 50 W 1
9506B Screwdriver, std 5/64 x 2-3/8 ESD 1	691 Cutter knife, 18 mm 1
9510B Screwdriver, Ph #0 x 2-3/8 ESD 1	291 Wire stripper plier, 10-20 AWG 1
9511B Screwdriver, Ph #1 x 3-5/32 ESD 1	



ITEM JEL11      PIECES 11      1 AVAILABLE On Request

### ELECTRONIC TOOL SET

INDUSTRIAL DUTY

9  
PIECES



Content	Content
CPU17 Plastic tool box, 17 x 9 x 8" 1	28141 Plier, 5" diagonal cut 1
UD12 600 VCD/600 VCA Digital multimeter 1	28560 Plier, 4-3/4" conical point 1
CAU50 Soldering iron, 50 W 1	308 UTP cable stripper 1
686A Pocket knife, stainless steel 1	
8624 Screwdriver, cabinet 1/8 x 4 bimaterial 1	
8680 Screwdriver, Ph#0 1/8 x 2-1/2 bimaterial 1	



ITEM JEL9      PIECES 9      1 AVAILABLE On Request

**MULTIMETER SETS WITH TOOLS**

**MULTIMETER AND TOOLS SET**



**6**  
PIECES



Content	
UD12	Basic compact multimeter 1
9308L	7 In 1 screwdriver 1
PVU01	24-1000 V voltage tester 1
689AR	Automatic utility knife 1
LPA10	1 LED 2 AA flashlight 1
EMUC	Multipurpose case 1

ITEM	PIECES	AVAILABLE
JM6	6	On Request

**MULTIMETER AND TOOLS SET**



**4**  
PIECES



Content	
UD179	Latest generation multimeter 1
PVU02	Voltage tester 24-1000 V 1
18675	15 in 1 multitool 1
CP110	10.5" waterproof box 1

ITEM	PIECES	AVAILABLE
JM4	4	On Request

**MULTIMETER AND TOOLS SET**



**3**  
PIECES



Content	
CPU17	Plastic tool box, 17 x 9 x 8" 1
UD12	600 VCD/600 VCA Digital multimeter 1
CAU50	Soldering iron, 50 W 1

ITEM	PIECES	AVAILABLE
JEL3	3	On Request

**COMBINATION TOOL SET WITH ELECTRICAL TESTERS**



**5**  
PIECES



Content	
MUL05	600 V Digital multimeter clamp-on 1
120527	Folding multi-tool 13 functions 1
LIAL80	Aluminum body led flashlight 80 lm 1
PVS01	Voltage tester non-contact 90 V to 1000 V 1
EMSC	Multipurpose toolcase stl s 1

ITEM	PIECES	AVAILABLE
JPE5	5	On Request

**MULTIMETERS**

**DIGITAL TRUE RMS MULTIMETERS**



**2 AA**  
BATTERIES



Features	
Electrical protection	CAT II 1000V CAT III 600V
Voltage	1000 V CA/CD
Resistance	40MΩ
Current	600μA - 10A CA/CD
Capacitance	9999μF
Temperature	-200 a 1350 °C -328 a 2462 °F
True Rms	•
Auto off	•
Hold function	•
Backlight	•
Continuity test with audible alarm	•
Diode test	•
Range selection	Auto / Manual
Screen	3-1/2 digits 6000 accounts
Quick answer	1ms

- Heavy duty protective case.
- Integrated kickstand.



ITEM	BATTERY	AVAILABLE
UD85	2 AA	✓



**9 V**  
BATTERY



Features	
Electrical protection	CAT III 1000V
Voltage	1000 V CA/CD
Resistance	40MΩ
Current	400μA-10A CA/CD
Capacitance	40nF-100μF
Frequency test	5Hz-10MHz
Temperature	-40 a 1300 °C -40 a 2372 °F
True Rms	•
Auto off	•
Hold function	•
Backlight	•
Continuity test with audible alarm	•
Diode test	•
Duty cycle test	•
Range selection	Auto / Manual
Screen	3-3/4 digits 4000 accounts

- Heavy duty protective case.
- Access to batteries and fuses without damaging equipment calibration.
- Integrated kickstand.
- Thermocouple included.



ITEM	BATTERY	AVAILABLE
UD179	9V	✓

## MULTIMETERS

### AUTORANGING DIGITAL MULTIMETER

**INDUSTRIAL DUTY** **CATIII PROTECTION**

**9V BATTERY**



Features	
Electrical protection	CAT III 1000V
Voltage	1000 V CA/CD
Resistance	40M $\Omega$
Current	400 $\mu$ A-10A CA/CD
Capacitance	40nF-100 $\mu$ F
Frequency test	5Hz-10MHz
Auto off	•
Hold function	•
Backlight	•
Continuity test with audible alarm	•
Diode test	•
Duty cycle test	•
Range selection	Auto / Manual
Screen	3-3/4 digits 4000 accounts

- Heavy duty protective case.
- Access to batteries and fuses without damaging equipment calibration.
- Integrated kickstand.
- Thermocouple included.



ITEM	BATTERY	AVAILABLE
UD112	9V	1 ✓



### COMPACT DIGITAL MULTIMETERS

**INDUSTRIAL DUTY** **CATII & CATIII PROTECTION**

**2 AA BATTERIES**



Features	
Electrical protection	CAT II 1000V CAT III 600V
Voltage	1000 V CA/CD
Resistance	40M $\Omega$
Current	600 $\mu$ A-2000 $\mu$ A CA / CD
Capacitance	9999 $\mu$ F
Auto off	•
Hold function	•
Backlight	•
Continuity test with audible alarm	•
Diode test	•
Range selection	Auto / Manual
Screen	3-1/2 digits 6000 accounts

- Heavy duty protective case.
- Integrated kickstand.



ITEM	BATTERY	AVAILABLE
UD18	2 AA	1 ✓

**INDUSTRIAL DUTY** **CATIII PROTECTION**

**2 AA BATTERIES**



Features	
Electrical protection	CAT III 600V
Voltage	600 V CA/CD
Resistance	200 $\Omega$
Auto off	•
Continuity test with audible alarm	•
Range selection	Manual
Screen	3 1/2 digits 2 000 accounts

- Heavy duty protective case.
- Integrated kickstand.



**URREA**  
SUPERIOR QUALITY AFFORDABLE TOOLS

usa.urrea.com

ITEM	BATTERY	AVAILABLE
UD12	9V	1 ✓

### PROFESSIONAL DIGITAL MULTIMETER

**PROFESSIONAL USE** **CATII & CATIII PROTECTION** **NCV**

**2 AA BATTERIES**



Features	
Electrical protection	CAT II 1000V CAT III 600V
Voltage	750V CA 1000V CD
Resistance	40M $\Omega$
Current	400 $\mu$ A-10A CD/CA
Capacitance	4nF-10mF
Frequency test	10 Hz a 1 MHz
Temperature	-40 a 1000 °C -40 a 1832 °F
Nav (icono en pieza)	•
Auto off	•
Hold function	•
Backlight	•
Continuity test with audible alarm	•
Diode test	•
Range selection	Manual
Screen	3-3/4 digits 4000 accounts

- Housing with rubber cover.
- Batteries not included.



ITEM	DESCRIPTION	AVAILABLE
MUL03	Professional multimeter 1,000 V	1 On Request

### DIGITAL MULTIMETER

**PROFESSIONAL USE** **CATII PROTECTION**

**2 AAA BATTERIES**



Features	
Electrical protection	CAT III 600V
Voltage	600 V CA/CD
Resistance	20M $\Omega$
Current	200 $\mu$ A-10A CD
Auto off	•
Hold function	•
Backlight	•
Continuity test with audible alarm	•
Diode test	•
Range selection	Manual
Screen	3 1/2 Digits 2000 accounts

- Housing with rubber cover.
- Batteries not included.



ITEM	DESCRIPTION	AVAILABLE
MUL02	Digital multimeter 600 V	1 On Request

CLAMP-ON MULTIMETERS

DIGITAL POWER CLAMP-ON MULTIMETER

INDUSTRIAL DUTY CAT III & CAT IV PROTECTION TRUE RMS NCV  
 2 AAA BATTERIES

URREA  
 IMPROVED PRODUCT

Features	
Electrical protection	CAT III 1000V CAT IV 600V
Voltage	1000V CA/CD
Resistance	40MΩ
Current	400μA-2000A CA/CD
Capacitance	40nF-2000μF
True Rms	•
Ncv	•
Auto off	•
Hold function	•
Backlight	•
Continuity test with audible alarm	•
Diode test	•
Analog bar graph reading	•
Range selection	Auto / Manual
Screen	3-3/4 digits 4000 accounts



- Clamp inner diameter: 50 mm.
- Heavy duty protective case.
- Includes case.
- Trigger for hook opening.



ITEM	BATTERY	AVAILABLE
UD337	2 AAA	1 On Request

DIGITAL CLAMP MULTIMETER

INDUSTRIAL DUTY CAT III & CAT III PROTECTION TRUE RMS NCV  
 2 AAA BATTERIES

URREA  
 IMPROVED PRODUCT

Features	
Electrical protection	CAT II 1000V CAT III 600V
Voltage	750V CA 1000V CD
Resistance	40MΩ
Current	40A-400A CA/CD
Frequency test	0.5Hz-200KHz
True Rms	•
NCV	•
Auto off	•
Hold function	•
Continuity test with audible alarm	•
Diode test	•
Duty cycle test	•
Analog bar graph reading	•
Range selection	Auto / Manual
Screen	3-3/4 digits 4000 accounts



- Clamp inner diameter: 32 mm.
- Includes case.
- Trigger for hook opening.



ITEM	BATTERY	AVAILABLE
UD334	2 AAA	1 ✓

CLAMP-ON DIGITAL MULTIMETER

INDUSTRIAL DUTY CAT III & CAT III PROTECTION NCV  
 2 AAA BATTERIES

URREA  
 IMPROVED PRODUCT

Features	
Electrical protection	CAT II 1000V CAT III 600V
Voltage	750 V CA 1000V CD
Resistance	40MΩ
Current	400μA-4000A CA/CD
Frequency test	0.5Hz-200KHz
NCV	•
Auto off	•
Hold function	•
Continuity test with audible alarm	•
Diode test	•
Duty cycle test	•
Range selection	Auto / Manual
Screen	3-3/4 digits 4000 accounts



- Clamp inner diameter: 32 mm.
- Includes case.
- Trigger for hook opening.



ITEM	BATTERY	AVAILABLE
UD333	2 AAA	1 ✓

AUTOMOTIVE MULTIMETERS

AUTOMOTIVE DIGITAL MULTIMETER

INDUSTRIAL DUTY AUTOMOTIVE USE CAT III & CAT III PROTECTION 9 V BATTERY

URREA  
 IMPROVED PRODUCT

Features	
Electrical protection	CAT I 1000V CAT III 600V
Voltage	750V CA 1000V CD
Resistance	40MΩ
Current	1μA - 10A CA/CD
Frequency test	0.5Hz-200KHz
Temperature	-40 a 1370 °C -40 a 2498 °F
Auto off	•
Hold function	•
Backlight	•
Continuity test with audible alarm	•
Diode test	•
Duty cycle test	•
Analog bar graph reading	•
Automotive electronics test	•
RPM Measurement, test	•
Dwell interval test	•
Test pulse width	•
Range selection	Auto / Manual
Screen	3-3/4 digits 4000 accounts



- Heavy duty protective case.
- Integrated kickstand.
- Includes plastic case.



ITEM	BATTERY	AVAILABLE
UD88	9V	1 On Request

AUTOMOTIVE DIGITAL MULTIMETER

INDUSTRIAL DUTY AUTOMOTIVE USE CAT III PROTECTION 9 V BATTERY

URREA  
 IMPROVED PRODUCT

Features	
Electrical protection	CAT III 600V
Voltage	600 V CA/CD
Resistance	40MΩ
Current	1mA - 10A CD
Frequency test	0.5 Hz - 200 KHz
Auto off	•
Funcion hold	•
Backlight	•
Continuity test with audible alarm	•
Duty cycle test	•
Lectura en grafica de barras analoga	•
Prueba de electronica automotriz	•
Prueba de medicion de rpm	•
Dwell interval test	•
Test pulse width	•
Range selection	Auto / Manual
Screen	3-3/4 digits 4000 accounts



- Heavy duty protective case.
- Integrated kickstand.



ITEM	BATTERY	AVAILABLE
UD226	9V	1 ✓

AUTOMOTIVE DIGITAL MULTIMETER

PROFESSIONAL USE AUTOMOTIVE USE CAT III & CAT III PROTECTION 9 V BATTERY

SURTEK  
 TOOLS FOR SPECIALISTS

Features	
Electrical protection	CAT II 1000V CAT III 600V
Voltage	750V CA 1000V CD
Resistance	20MΩ
Current	200mA-10A CD
Auto off	•
Hold function	•
Backlight	•
Continuity test with audible alarm	•
Diode test	•
Automotive electronics test	•
RPM Measurement, test	•
Dwell interval test	•
Range selection	Manual
Screen	3-1/2 digits 2000 accounts



- Protective case.
- Extra long screen.



ITEM	DESCRIPTION	AVAILABLE
MUL04	Automotive digital multimeter 1,00V	1 On Request

## DIGITAL POWER CLAMP MULTIMETER

### DIGITAL POWER CLAMP-ON MULTIMETERS



Features	
Electrical protection	CAT III 600V
Voltage	750V CA
Current	700A CA
True Rms	•
Auto off	•
Hold function	•
Backlight	•
Analog bar graph reading	•
Range selection	Auto / Manual
Screen	3-3/4 digits 4000 accounts

- Measurement of real power, apparent power and reactive power.
- Clamp inner diameter: 52 mm.
- Trigger for hook opening.



ITEM	BATTERY	AVAILABILITY
UD370	9V	1 ✓

## MULTIMETER ACCESSORY

### MULTIMETER ACCESSORY



- It allows a connection to a computer in the RS-232C port, to feed, store information and also to program the diagnostic equipment.
- 0.313" (8 mm) max jaw opening.
- Straight ends with protecting cover.



ITEM	DESCRIPTION	AVAILABILITY
UD71TLC	Test Leads with Alligator Clips	1 ✓

## VOLTAGE TESTER

### VOLTAGE TESTER, NON-CONTACT



**24/1000 V**  
VOLTAGE



- Ideal non-contact voltage detector to perform installations or detect problems in electrical wiring.
- Safety class CAT IV 1000 V.
- Remote voltage tester, you don't need to touch the surface to take readings.
- Operating temperature: 32°F~104°F.
- Small and easy to handle.



ITEM	VOLTAGE RANGE	BUZZER	MAGNETIC FIELD DETECTOR	AVAILABILITY
PVU01	24V - 1000V	Yes	No	1 On Request
PVU02	24V - 1000V	No	Yes	1 On Request

### NON-CONTACT VOLTAGE TESTERS



- Ideal non-contact voltage tester for installations or troubleshooting electrical wiring.
- CAT IV 1000 V protection.
- Remote voltage tester, no need to touch the surface to take readings.
- Operates in temperatures from -4° to 122°F.
- Compact and easy to handle.



ITEM	VOLTAGE RANGE	LOW VOLTAGE MODE	AVAILABILITY
PVS01	90V - 1000V	No	1 On Request
PVS02	24V - 1000V	Yes	1 On Request

### LOGIC LED CIRCUIT TESTER



- Check high and low voltages.
- Dual color LED indicates power (red) and ground (green).
- Stainless steel tip.



ITEM	VOLTAGE	TIP LENGTH	AVAILABILITY
23501	0 - 24V	3-1/2" / 90 mm	1 ✓

### EXTRA LONG TIP CIRCUIT TESTERS



- High resistance insulated tip.
- Extra long tip for testing circuits in hard to reach areas.
- Impact resistant plastic body.
- Makes automotive maintenance tasks easier.
- Ideal for testing 6 to 12 V DC circuits in cars, boats, motorcycles, trucks, trailers, and buses.



ITEM	VOLTAGE	TIP LENGTH	AVAILABILITY
23503	6 - 24V	6-11/16" / 170 mm	1 ✓
23502	6 - 12V	7-1/16" / 180 mm	1 ✓

DIAGNOSTIC AND MEASURING TOOLS



**VOLTAGE TESTER**

**CIRCUIT TESTER**

**INDUSTRIAL DUTY** **12/24 V**  
VOLTAGE



- DC heavy duty circuit tester.
- Useful for detecting direct current (DC) flow.
- 20 awg gauge insulated wire.



ITEM	VOLTAGE	LENGTH	☞	AVAILABLE
2350	0-28 VCD, 7 A mx.	7-9/32" /184 mm	1	✓

**CURRENT CONTINUITY TESTER**

**INDUSTRIAL DUTY** **2.5 A** **1AA BATTERY**  
CURRENT



- Battery required (not included).
- Ideal for detecting open or damaged power lines.
- 24 AWG gauge insulated wire.



ITEM	AMPS	LENGTH	☞	AVAILABLE
2352	2.5 A	7-7/8" /185 mm	1	✓

**DC CIRCUIT TESTER**

**INDUSTRIAL DUTY** **12 V**  
VOLTAGE



- Ideal for detecting open or damaged power lines in series-parallel systems.
- 24 AWG gauge insulated wire.



ITEM	VOLTAGE	LENGTH	☞	AVAILABLE
2351	0-12 VCD	7-7/8" /185 mm	1	✓

**IN-LINE SPARK TESTER**

**INDUSTRIAL DUTY**



- It is connected between the bujia and the cable of the bujia to detect functionality in the ignition.
- 7 AWG gauge insulated wire.
- Exposed tip 2-1/8" tip diameter 1/4".



ITEM	VOLTAGE	LENGTH	☞	AVAILABLE
2355	0-28 VCD	9-3/4" /247 mm	1	✓

**CIRCUIT TESTERS**

**PROFESSIONAL USE** **100/500 V**  
VOLTAGE



DPC02



DCA19



- NOM-003-SCFI-2000; NMX-J-521/1-ANCE-1999 standards.
- Plastic body that grants security to the user in the verification of the current.
- Helps identify polarity.

ITEM	VOLTAGE	LENGTH	☞	AVAILABLE
DPC02	100-500 V	5-1/2" /14 cm	12	On Request
DCA14	100-500 V	5-1/2" /14 cm	12	On Request
DCA19	100-500 V	7-7/16" /19 cm	12	On Request

**CIRCUIT TESTERS**

**PROFESSIONAL USE** **1.5 V** **1AA BATTERY**  
VOLTAGE



- Verifies continuity in circuits without voltage.
- Requires a 1.5 V AA battery.



ITEM	VOLTAGE	LENGTH	☞	AVAILABLE
107311	1.5 V	8-1/4" /21 cm	6	On Request

## VOLTAGE TESTER

### CIRCUIT TESTERS



**0/24V**  
VOLTAGE



- Neon indicator.
- Chrome vanadium steel tip.
- Insulated plastic handle.

**107358**



**6/12V**  
VOLTAGE



- Neon indicator.
- 16 gauge wire.

**107303**



**6/24V**  
VOLTAGE



- Heavy duty tester.
- 60" reinforced cable.
- Stainless steel tip.

**107304**



**SURTEK**  
TOOLS FOR SPECIALISTS

ITEM	VOLTAGE	LENGTH	AVAILABILITY
<b>107358</b>	0 - 24V	5-1/16"/13 cm	12 On Request
<b>107303</b>	6 - 12V	8-7/16"/21.5 cm	6 On Request
<b>107304</b>	6 - 24V	7-1/16"/18 cm	6 On Request

## INFRARED THERMOMETER

### INFRARED THERMOMETER



- Laser sight that can be turned on and off.
- Accurate measurements for a long time.
- Operation switch.
- LED screen.

- Uses:
- Electrical maintenance.
  - Automotive repair and maintenance.
  - Air conditioners.
  - Manufacturing process.
  - Anywhere where the temperature needs to be monitored.

**UD70**



- NOM-024-SCFI-2013 standard.
- Reading objects at great distances.
- Auto power off.
- Circular laser with 8 points.
- Non-contact temperature measurement.

**UD80**



- Temperature increase.
- Self measure.
- Audible alarms.
- 10 memory points.

**URREA**  
TOOLS FOR SPECIALISTS



ITEM	RELATION DISTANCE/ POINT	MEMORY POINTS	RESPONSE TIME	RESOLUTION	OPERATION RANGE		AVAILABILITY
					°C	°F	
<b>UD70</b>	12:01	8	1 s	0.1 °F / 0.1 °C	-60 a 550 °C	-76 a 1,022 °F	1 ✓
<b>UD80</b>	12:1	10	500 ms	0.1 °F / 0.1 °C	-50 a 999 °C	-58 a 1,830 °F	1 On Request

## MICROMETERS AND VERNIER CALIPER

### MEASUREMENT TOOL SET



**5**  
PIECES

Content	Quantity
<b>800112IN</b> Inside Caliper 12"	1
<b>800112EX</b> Outside Caliper 12"	1
<b>800112DV</b> Spring Divider 12"	1
<b>UMCV6</b> Vernier Caliper 0 To 6"	1
<b>80047</b> Sliding T-Bevel 7"	1



- Made from high grade steel with knurled locking mechanism, and machined, heat treated tips.
- Suitable for CNC machining and measurement tasks.
- NOM-050-SCFI-2004.

ITEM	PIECES	AVAILABILITY
<b>JMD5</b>	5	1 On Request

**URREA**  
TOOLS FOR SPECIALISTS



**NEW**



### MICROMETERS AND CALIPERS



**IP 65 GRADE** **STAINLESS STEEL**

- Blocker spindle.
- Knob with ratchet-type system.
- Digital LCD screen with auto-off.
- Graduated cylinder in millimeters.



**URREA**  
TOOLS FOR SPECIALISTS



ITEM	SIZE	TOLERANCE	MINIMUM MEASURING RANGE		MAXIMUM MEASURING RANGE		RESOLUTION		AVAILABILITY
			IN	MM	IN	MM	IN	MM	
<b>UMM01</b>	0 - 1"	±0.03 mm	0.00005"	0.001 mm	1"	25 mm	0.00005"	0.001 mm	1 On Request
<b>UMM12</b>	1" - 2"	±0.03 mm	1"	25 mm	2"	50 mm	0.00005"	0.001 mm	1 On Request

**MICROMETERS AND VERNIER CALIPER**

**DIGITAL MICROMETER**



- Stainless steel body for enhanced corrosion resistance.
- Ratchet type thimble.
- LCD digital display.



ITEM	SIZE		TOLERANCE	MINIMUM MEASURING RANGE		MAXIMUM MEASURING RANGE		RESOLUTION		Q	AVAILABLE
	IN	MM		IN	MM	IN	MM	IN	MM		
122230	0 - 1"	25.4	±0.03 mm	1/128"	05	6"	150	0.00005"	0.001 mm	1	On Request

**MICROMETERS AND CALIPERS**



**UMCD8**

- Millimeter and inches graduation.
- LCD digital display.
- Accuracy according to DIN 862.
- Jaws with fine ground hardened steel.
- Uses: For internal external measurements, steps and depth.



ITEM	SIZE		TOLERANCE	MINIMUM MEASURING RANGE		MAXIMUM MEASURING RANGE		RESOLUTION		Q	AVAILABLE
	IN	MM		IN	MM	IN	MM	IN	MM		
UMCD6	0 - 6"	152.4 mm	±0.03 mm	0.01"	0.0005 mm	6"	150 mm	0.01"	0.0005 mm	1	On Request
UMCD8	0 - 8"	203.2 mm	±0.03 mm	0.01"	0.0005 mm	8"	200 mm	0.01"	0.0005 mm	1	On Request

**DIGITAL CALIPERS**

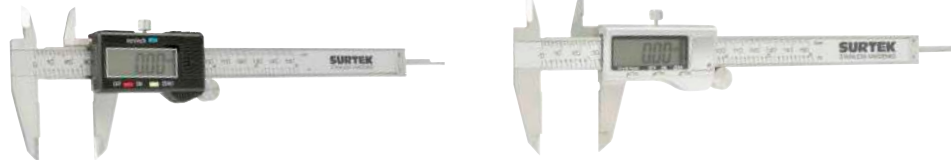

**122200**

- Stainless steel body for enhanced corrosion resistance.
- Dual scale in millimeters and inches.
- LCD digital display.

- Stainless steel body for enhanced corrosion resistance.
- Dual scale in millimeters and inches.
- LCD digital display.

**122204**

ITEM	SIZE		TOLERANCE	MINIMUM MEASURING RANGE		MAXIMUM MEASURING RANGE		RESOLUTION		Q	AVAILABLE
	IN	MM		IN	MM	IN	MM	IN	MM		
122200	0 - 6"	152.4	±0.03 mm	0.005"	0.1 mm	6"	150	0.001"	0.03 mm	1	On Request
122204	0 - 6"	152.4	±0.03 mm	0.005"	0.1 mm	6"	150	0.001"	0.03 mm	1	On Request

**MICROMETERS AND CALIPERS**



**UMCC6**

- Millimeter and inches graduation.
- Shockproof dial indicator.
- Adjustable locking screw 0-6 inch range.
- Uses: For internal and external measurements, steps and depth.



ITEM	SIZE		TOLERANCE	MINIMUM MEASURING RANGE		MAXIMUM MEASURING RANGE		RESOLUTION		Q	AVAILABLE
	IN	MM		IN	MM	IN	MM	IN	MM		
UMCC6	0 - 6"	152.4 mm	±0.03 mm	0.001"	0.02 mm	6"	150 mm	0.001"	0.02 mm	1	On Request

## MICROMETERS AND VERNIER CALIPER

### DIGITAL CALIPERS



**SURTEK**  
TOOLS FOR SPECIALISTS



**NEW**



122202



122201

- Stainless steel body for enhanced corrosion resistance.
- Scale in inches.



- Stainless steel body for enhanced corrosion resistance.
- Scale in inches.



ITEM	SIZE		TOLERANCE	MINIMUM MEASURING RANGE		MAXIMUM MEASURING RANGE		RESOLUTION		QTY	AVAILABLE
	IN	MM		IN	MM	IN	MM	IN	MM		
122202	0 - 6"	150	±0015"	001"	02	6"	150	0.001"	0.03 mm	1	On Request
122201	0 - 6"	150	±03 mm	001"	02	6"	150	0.001"	0.03 mm	1	On Request

### MICROMETERS AND CALIPERS



**URREA**  
TOOLS FOR SPECIALISTS



- Millimeter and inches graduation.
- Locking screw for accurate measurements.
- Uses: For internal and external measurements, steps and depth.
- Monobloc cursor.



ITEM	SIZE		TOLERANCE	MINIMUM MEASURING RANGE		MAXIMUM MEASURING RANGE		RESOLUTION		QTY	AVAILABLE
	IN	MM		IN	MM	IN	MM	IN	MM		
UMCV6	0 - 6"	152.4 mm	±0.03 mm	1/128"	0.05 mm	6"	150 mm	1/128"	0.05 mm	1	On Request

### DIGITAL MICROMETERS AND VERNIER CALIPERS



**SURTEK**  
TOOLS FOR SPECIALISTS



**NEW**



122206



122203

- Stainless steel body for enhanced corrosion resistance.
- Dual scale in millimeters and inches.



- Stainless steel body for enhanced corrosion resistance.
- Dual scale in millimeters and inches.



ITEM	SIZE		TOLERANCE	MINIMUM MEASURING RANGE		MAXIMUM MEASURING RANGE		RESOLUTION		QTY	AVAILABLE
	IN	MM		IN	MM	IN	MM	IN	MM		
122203	0 - 6"	152.4	±03 mm	001"	02	6"	150	0.007"	0.2 mm	1	On Request
122206	0 - 6"	152.4	±03 mm	1/128"	05	6"	150	0.001"	0.02 mm	1	On Request

## LONG TAPES

### LONG STEEL TAPE



**SURTEK**  
TOOLS FOR SPECIALISTS



**NEW**



CL20

CL30

CL50

- More rigid and resistant compact box.
- 1/2" blade width.
- Two-ink printing for easy reading.
- Ease to use due to its opening design in the center.
- NOM-046-SCFI-1999 standard.



ITEM	LENGTH	BLADE WIDTH	QTY	AVAILABLE
CL20	65 ft / 20 m	1/2" / 13 mm	1	✓
CL30	98.4 ft / 30 m	1/2" / 13 mm	1	✓
CL50	164 ft / 50 m	1/2" / 13 mm	1	On Request

**LONG TAPES**

**FIBERGLASS LONG TAPES REEL**



CLFX30 CLFX50

- Reinforced crosshead design.
- ABS plastic case and TPU coating on handle resistant to high temperatures and impacts.
- 30-meter tape made of fiberglass that does not deform due to changes in temperature.
- Plastic lever for quick winding.
- Ideal for use in construction related activities.



ITEM	LENGTH	TAPE WIDTH	☐	AVAILABLE
CLFX30	98.4 ft / 30 m	9/16" / 15 mm	1	On Request
CLFX50	164 ft / 50 m	9/16" / 15 mm	1	On Request

**FIBERGLASS LONG TAPES**



CLF30 CLF50

- ABS plastic case and TPU coating on handle resistant to high temperatures and impacts.
- 30-meter tape made of fiberglass that does not deform due to changes in temperature.
- Plastic lever for fast winding of 3:1.
- Double hook fix system.
- Double face blade graduated in centimeters and inches.



ITEM	LENGTH	TAPE WIDTH	☐	AVAILABLE
CLF30	98.4 ft / 30 m	9/16" / 15 mm	1	On Request
CLF50	164 ft / 50 m	9/16" / 15 mm	1	On Request

**LONG FIBERGLASS OPEN REEL MEASURING TAPES**

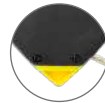

Toothed reinforced tip.



CLX30 CLX50 CLX100

- Ergonomic handle.
- Plastic box, crosshead type.
- TPR handle.
- Wind system five times faster than traditional tapes.



ITEM	LENGTH	BLADE WIDTH	☐	AVAILABLE
CLX30	65 ft / 20 m	1/2" / 13 mm	1	On Request
CLX50	98.4 ft / 30 m	1/2" / 13 mm	1	On Request
CLX100	164 ft / 50 m	1/2" / 13 mm	1	On Request

**LONG FIBERGLASS TAPES**



CLFV20 CLFV30 CLFV50

- Tape made of fiberglass.
- 100% plastic rewind mechanism that prevents rust.



ITEM	LENGTH	BLADE WIDTH	☐	AVAILABLE
CLFV20	65 ft / 20 m	1/2" / 13 mm	1	On Request
CLFV30	98.4 ft / 30 m	1/2" / 13 mm	1	On Request
CLFV50	164 ft / 50 m	1/2" / 13 mm	1	On Request

## LASER DISTANCE METER

### RECHARGEABLE LASER DISTANCE METERS



NEW



- Multifunction buttons.
- Memory for up to 300 measurements.
- Rechargeable battery.
- Unit conversion.
- Measurement units in meters, inches and feet.
- Impact resistant.
- IP 40 protection rating.
- Volume and area measurement.

ITEM	MAXIMUM RANGE	BATTERY	LASER COLOR	☐	AVAILABLE
D140	131 ft / 40 m	Rechargeable	Red	1	On Request
D1100	328 ft / 100 m	Rechargeable	Green	1	On Request

## MEASURING TAPES

### IMPACT RESISTANT MEASURING TAPES



Blade printed on both sides, with 7 different graduations and covered with anti-abrasive varnish.



Hook with Dual magnet. 4 rivets.



Metal belt clip.

- ABS plastic case with TPR cover.
- Blade color: white both sides.
- NOM-046-SCFI-1999 standard.



ITEM	BLADE LENGTH	BLADE WIDTH	☐	AVAILABLE
1586HD	16.4 ft / 5 m	1-1/16" / 27 mm	1	✓
1589HD	26.2 ft / 8 m	1-1/16" / 27 mm	1	On Request

### HIGH-VISIBILITY IMPACT RESISTANT MEASURING TAPES



NEW

High visibility fluorescent nylon coated tape.



Auto lock mechanism.



Steel belt clip for secure attachment.

- Closed ABS plastic case with TPR cover.
- Nylon coated metal tape, graduated on both sides.
- Exceeds NOM-046-SCFI-1999 standard.



ITEM	BLADE LENGTH	BLADE WIDTH	☐	AVAILABLE
FLXAV3	9.8 ft / 3 m	1-1/16" / 27 mm	1	On Request
FLXAV5	16.4 ft / 5 m	1-1/16" / 27 mm	1	On Request
FLXAV8	26.2 ft / 8 m	3/4" / 19 mm	1	On Request

DIAGNOSTIC AND MEASURING TOOLS

**MEASURING TAPES**

**STAINLESS STEEL MEASURING TAPES**



Both-side printed tape with large numbers for easy readings.



Double magnetic hook reinforced with three rivets.



Metallic belt clip.



1595LSW

1598LSW

1599LSW

- Closed ABS plastic case with metal reinforcements for enhanced durability.
- Nylon coated steel tape, graduated on both sides.
- Exceeds NOM-046-SCFI-1999 standard.

ITEM	BLADE LENGTH	BLADE WIDTH	☐	AVAILABLE
1595LSW	9.8 ft / 3 m	1-1/8" / 30 mm	1	On Request
1598LSW	26.2 ft / 8 m	1-1/8" / 30 mm	1	On Request
1599LSW	34.8 ft / 10 m	1-1/8" / 30 mm	1	On Request



**MEASURING TAPES**



Blade printed on both sides, with 7 different graduations and covered with anti-abrasive varnish.



Hook with magnet.



Metal belt clip



1583LH

1586LH

1589LH

- Closed ABS plastic case.
- Steel tape graduated on both sides.
- Exceeds NOM-046-SCFI-1999 standard.

ITEM	BLADE LENGTH	BLADE WIDTH	☐	AVAILABLE
1583LH	9.8 ft / 3 m	3/4" / 19 mm	1	On Request
1586LH	19.6 ft / 6 m	1" / 25 mm	1	On Request
1589LH	29.5 ft / 9 m	1-1/8" / 30 mm	1	✓



**SILVER ANTI-IMPACT MEASURING TAPES**



Hook with three rivets.



Silver color blade, printed on both sides.



Double magnetic hook.



Shock absorber system.



Pause button with quick activation.



Wide blade.



B122085

B122086

B122087

- Closed ABS plastic case with TPR cover.
- Complies with NOM-046-SCFI-1999.

ITEM	BLADE LENGTH	BLADE WIDTH	☐	AVAILABLE
B122085	9.8 ft / 3 m	5/8" / 16 mm	6	✓
B122086	16.4 ft / 5 m	1" / 25 mm	6	✓
B122087	26.2 ft / 8 m	1" / 25 mm	6	✓



## MEASURING TAPES

### ANTI-IMPACT MEASURING TAPES



- Closed ABS plastic case.
- Complies with NOM-046-SCFI-1999.

B122080

B122081

B122082

ITEM	BLADE LENGTH	BLADE WIDTH	✓	AVAILABLE
B122080	9.8 ft / 3 m	5/8" / 16 mm	6	✓
B122081	16.4 ft / 5 m	1" / 25 mm	6	✓
B122082	26.2 ft / 8 m	1" / 25 mm	6	✓



### SOFT GRIP MEASURING TAPES



B122063

B122064

B122065

- Closed ABS plastic case with TPR cover.
- Soft textured body for improved grip.
- Complies with NOM-046-SCFI-1999.

ITEM	BLADE LENGTH	BLADE WIDTH	✓	AVAILABLE
B122063	9.8 ft / 3 m	5/8" / 16 mm	6	On Request
B122064	16.4 ft / 5 m	3/4" / 19 mm	6	On Request
B122065	24 ft / 7.5 m	1" / 25 mm	6	On Request



### INVINCIBLE PLASTIC CASE MEASURING TAPES



B122070

B122071

- Closed ABS plastic case.
- Complies with NOM-046-SCFI-1999.

ITEM	BLADE LENGTH	BLADE WIDTH	✓	AVAILABLE
B122070	9.8 ft / 3 m	3/4" / 19 mm	6	✓
B122071	16.4 ft / 5 m	1" / 25 mm	6	✓





**MEASURING TAPES**

**IMPULSE STRIP WITH ANTI-IMPACT MEASURING TAPES**



**13**  
PIECES



Content		
136151	16' anti-impact measure tape	12
TIMP100	Impulse strip	1

ITEM	DESCRIPTION	☐	AVAILABLE
126448	12 measuring tapes plus impulse strip	1	✓

**MEASURING WHEEL, 6" WHEEL**



- Maximum length: 106 cm
- Folded length: 56 cm
- Automatic regression button.
- The measurement increases when rotated the wheel forward and decreases when turned backwards.
- Foldable design.
- Plastic wheel with rubber coating.
- Handle with rubber grip.

ITEM	MAX. MEASUREMENT CAPACITY	WHEEL SIZE	☐	AVAILABLE
122268	32808.4 ft / 10,000 m	6" (15,2 cm)	1	On Request

**MEASURING WHEELS**

**MEASURING WHEEL, 12" WHEEL**



Brake on handle.



- Maximum length: 110 cm
- Folded length: 56 cm
- Automatic regression button.
- The measurement increases when rotated the wheel forward and decreases when turned backwards.
- Foldable design.
- Plastic wheel with rubber coating.
- Handle with ergonomic coating.

ITEM	MAX. MEASUREMENT CAPACITY	WHEEL SIZE	☐	AVAILABLE
122270	32808.4 ft / 10,000 m	12" (30,5 cm)	1	On Request

**MEASURING WHEEL, DOUBLE 6" WHEEL**



- Maximum length: 95 cm
- Folded length: 44 cm
- Automatic regression button.
- The measurement increases when rotated the wheel forward and decreases when turned backwards.
- Foldable design.
- Double plastic wheels with rubber coating.
- Handle with rubber grip.

ITEM	MAX. MEASUREMENT CAPACITY	WHEEL SIZE	☐	AVAILABLE
122269	32808.4 ft / 10,000 m	6" (15,2 cm)	1	On Request

**CALIPERS**

**CALIPERS SET**



**3**  
PIECES



NEW

Content		
80018IN	Inside calipers 8"	1
80018EX	Outside calipers 8"	1
80018DV	Spring dividers 8"	1

ITEM	PIECES	☐	AVAILABLE
JC03	3	1	On Request

**INSIDE CALIPER**



80018IN

- Made of high grade steel.
- Spring keeps the caliper closed.
- Knurled lock saves time.

ITEM	SIZE	☐	AVAILABLE
80016IN	6"	1	On Request
80018IN	8"	1	On Request
800110IN	10"	1	On Request
800112IN	12"	1	On Request

## CALIPERS

### OUTSIDE CALIPERS

INDUSTRIAL DUTY EXTERIOR MEASUREMENT



80018EX

- Fine thread screw for greater precision.
- Spring keeps the caliper closed.
- Its design is ideal for accurate measurement work and reading.
- For external use.
- Machined ends.



### SPRING DIVIDERS CALIPERS

INDUSTRIAL DUTY DIVIDER TIP



80018DV

- Knurled knob enables one-handed 360° turning.
- Ideal for marking inked projects.
- Adjusting nut is smooth and precise.
- Divider caliper for transferring and comparing distances
- Heat treated edges decrease wear.



ITEM	SIZE	☐	AVAILABLE
80016EX	6"	1	On Request
80018EX	8"	1	On Request
800110EX	10"	1	On Request
800112EX	12"	1	On Request

ITEM	SIZE	☐	AVAILABLE
80016DV	6"	1	On Request
80018DV	8"	1	On Request
800110DV	10"	1	On Request
800112DV	12"	1	On Request

## SQUARES

### STEEL SQUARES

INDUSTRIAL DUTY



916404

- For internal use
- The square is precisely parallel and straight.
- Manufactured with SAE5160 steel, of 40-50 HRC hardness.



ITEM	SIZE (X)	☐	AVAILABLE
916404	8"	1	On Request
916406	12"	1	On Request

### MAGNETIC COMBINATION SQUARE

INDUSTRIAL DUTY MAGNETIC ADJUST



STAINLESS STEEL

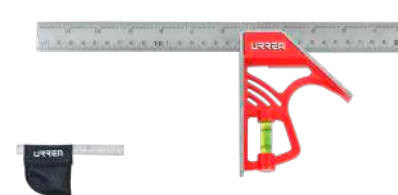

- Rule with thickness of 1/16".
- Includes textil pouch.
- Zinc alloy injection body.
- Rectified edges insure maximum accuracy.
- Graduated in centimeters and inches.



ITEM	SIZE	☐	AVAILABLE
800212	12"	1	✓

### COMBINATION SQUARE WITH MACHINED HEADS

PROFESSIONAL USE STAINLESS STEEL



NEW

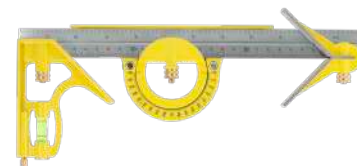

- High strength die cast zamac body.
- Graduated in centimeters and inches.
- Ideal for measuring horizontality, verticality, inside and outside squares, 45° level, marking gauge, and heights.



ITEM	SIZE	☐	AVAILABLE
122255	12"	1	On Request

### UNIVERSAL COMBINATION SQUARES WITH ZAMAC HANDLE

PROFESSIONAL USE STAINLESS STEEL



122258

- Sliding stainless steel slide.
- Ideal for 45 and 90 strokes.
- With spirit level to check horizontality and verticality.



ITEM	SIZE	☐	AVAILABLE
122257	6"	6	On Request
122254	12"	6	On Request
122258	16"	6	On Request

### PLASTIC HANDLE, COMBINATION SQUARE

PROFESSIONAL USE STAINLESS STEEL



- Sliding stainless steel slide.
- Ideal for 45 and 90 strokes.
- With spirit level to check horizontality and verticality.



ITEM	SIZE	☐	AVAILABLE
122265	12"	6	On Request

### SLIDING T-BEVEL

INDUSTRIAL DUTY STAINLESS STEEL

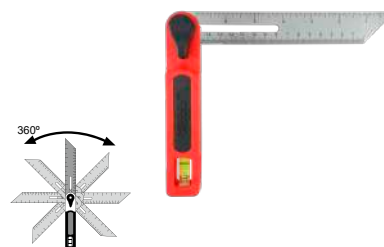

- High impact polymer handle.
- 3 windows for fast readings.
- Cylindrical bubble for easy reading.
- Marked for establishing adequate angles 15°, 30°, 45° and 60°..



ITEM	SIZE	☐	AVAILABLE
80047	7"	1	✓

DIAGNOSTIC AND MEASURING TOOLS

**SQUARES**

**FALSE SQUARE WITH PLASTIC HANDLE**



**STAINLESS STEEL**

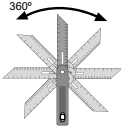

- Sliding steel slide.
- With spirit level and window to facilitate reading.
- High impact polypropylene plastic handle.
- To transport, trace or verify angles of any degree.

ITEM	SIZE	AVAILABILITY
122264	8"	On Request

**CARPENTER SQUARES WITH PLASTIC HANDLE**



**STAINLESS STEEL**



80038

- Unique support in the handle that allows you to stop the bracket in the required position without holding it in your hand.
- Graduation that allows you to make strokes in angels of: 15°, 22.5°, 30°, 36°, 45°, 50°, 60° and 90°.
- Thickness 1/16" ruler.
- Graduated in centimeters and inches.
- Handle manufacture in high impact polymer.

ITEM	SIZE	AVAILABILITY
80038	8"	On Request
800310	10"	✓
800312	12"	On Request
800316	16"	On Request

**CARPENTER SQUARES WITH PLASTIC HANDLE**



**STAINLESS STEEL**

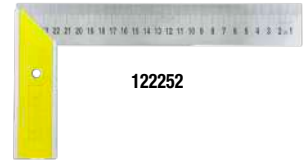

122252

- Stainless steel strip.
- With deep precision markings.

ITEM	SIZE	AVAILABILITY
122250	6"	On Request
122251	8"	On Request
122252	10"	On Request
122253	12"	On Request

**CARPENTER SQUARES**



**HIGH CARBON STEEL**



122280

- Made of high carbon steel.
- Graduation in centimeters and inches in low relief.
- Useful in checking internal and external straight angles.
- Ideal for 45 and 90 strokes.

ITEM	SIZE	AVAILABILITY
122280	8" x 12"	On Request
122281	16" x 24"	On Request

**STAINLESS STEEL RULERS**



122210

- With decimal equivalences table of inches on the reverse side.
- Pocket clip.



122211

- Made of stainless steel.
- Includes conversions tables on the reverse side.

ITEM	SIZE	AVAILABILITY
122210	6" (15 cm)	On Request
122211	12" (30 cm)	On Request

**LEVELS**

**ANTI-IMPACT ALUMINUM LEVELS TYPE "V"**



**3 VIALS**  
0°, 45° AND 90°

**ANTI-SHOCK RUBBER END CAPS**

**SELF CENTERING V GROOVE EDGE**



UNI24

- Aluminum profile body provides greater accuracy and durability.
- Molded grip.

ITEM	SIZE	AVAILABILITY
UNI24	24"	On Request
UNI48	48"	On Request

**DUAL-VIEW ALUMINUM LEVEL**



**3 VIALS**  
0°, 45° AND 90°

**ANTI-SHOCK RUBBER END CAPS**



UNI48D

- Double vision bubble allows you check against vertical leveling, eliminating strain on the back and neck while take the reading.
- Aluminum body that provides better accuracy and durability.
- Accuracy: 0.001 in / in.. (1 mm / m).

ITEM	SIZE	AVAILABILITY
UNI24D	24"	✓
UNI48D	48"	✓

## LEVELS

### ALUMINUM LEVELS TYPE "V"

**INDUSTRIAL DUTY** **3 VIALS** 0°, 45° AND 90° **ANTI-SHOCK RUBBER END CAPS**



UNI12A

• Tubular aluminum profile body.

ITEM	SIZE	VIALS	☐	AVAILABLE
UNI12A	12"	2	1	✓
UNI14A	14"	3	1	✓
UNI18A	18"	3	1	✓
UNI24A	24"	3	1	✓
UNI36A	36"	3	1	On Request
UNI48A	48"	3	1	✓

### ALUMINUM LEVELS

**GENERAL USE** **3 VIALS** 0°, 45° AND 90°



122103

\*Horizontal, vertical drops.  
 • Horizontal, vertical and 45 bubble vials with wide window for easy reading.  
 • Interchangeable drops with higher resistance to abrasion and impact.  
 • Meet with Federal GGG-L-211D.

ITEM	SIZE	VIALS	☐	AVAILABLE
122100*	10"	2	1	✓
122101*	12"	2	1	✓
122102	14"	3	1	✓
122103	18"	3	1	✓
122104	24"	3	1	✓
122105	36"	3	1	✓
122106	48"	3	1	✓

### TORPEDO MAGNETIC LEVEL

**PROFESSIONAL USE** **3 VIALS** 0°, 45° AND 90° **SELF CENTERING V FOR CURVES SURFACES**



• Body covered with rubber that resists impacts.  
 • Horizontal, vertical and 45 bubble vials with window wide for easy reading.  
 • Meet with federal GGG-L-211D.

ITEM	SIZE	VIALS	☐	AVAILABLE
122110	9"	3	1	✓

### ALUMINUM LEVELS TYPE "V"

**PROFESSIONAL USE** **3 VIALS** 0°, 45° AND 90° **ANTI-SHOCK RUBBER END CAPS**



**SELF CENTERING V FOR CURVES SURFACES**



With window in the frame to facilitate reading.



122122

• Made of injected aluminum.  
 • Plastic protected handle.  
 • Anodized finish for major protection.  
 • Plastic anti-impact bumpers at both ends for protection.  
 • "V" slot for use on tubular or curved surfaces.  
 • Meet with Federal GGG-L-211D.

ITEM	SIZE	VIALS	☐	AVAILABLE
122121	24"	3	1	✓
122122	36"	3	1	✓
122123	48"	3	1	✓
122124	72"	3	1	✓

### TORPEDO LEVEL TYPE "V"

**INDUSTRIAL DUTY** **3 VIALS** 0°, 45° AND 90° **ANTI-SHOCK RUBBER END CAPS**



**SELF CENTERING V GROOVE EDGE** **MAGNETIC EDGE**



• Aluminum box profile body for increased accuracy and durability.  
 • Extra reinforced ends to protect against impacts.  
 • Grooved profile for easier use on uneven surfaces.  
 • Dual view design for better bubble visibility.

ITEM	SIZE	VIALS	☐	AVAILABLE
UNT12	9"	3	1	On Request

## LASER LEVELS

### COMBINATION PROFESSIONAL MEASURING TOOL SET

**INDUSTRIAL DUTY**



**5 PIECES**

**NEW**



Content	Quantity
CP120 Safety Waterproof Tool Box 20" X 16" X 8"	1
NL2 2 Lines Semi-Automatic Laser Level	1
NL2E 2 Lines Laser Level For Tile	1
TNL Tripode For Laser Level 1.3 M	1
UNT12 Torpedo Level Type "V" 9"	1

ITEM	PIECES	☐	AVAILABLE
JMP5	5	1	On Request

**LASER LEVELS**

**AUTOMATIC LASER LEVELS**



URREA



Content NL12A	
Laser level	1
AA 1.5 V batteries	2
5 ft Tripod	1
Base for laser level	1
Laser vision glasses	1
Transport case	1
Target panel	1



NL12A

- Laser precision:  $\pm 0.006''$  / ft
- Working range: 65 ft
- Self leveling: <5 s
- Laser lines in all directions.
- Body protected with rubber anti-skid rubber.
- It has screw mounts to tripod or base for laser level.
- Function lock switch.



NL2A

Content NL2A	
Laser level	1
AA 1.5 V batteries	2
Base for laser level	1
Laser vision glasses	1
Target panel	1



ITEM	DESCRIPTION	AVAILABILITY
NL12A	Automatic laser level 12 lines 360°	1 ✓

ITEM	DESCRIPTION	AVAILABILITY
NL2A	2-line automatic laser level	1 ✓

**2 LINES SEMI-AUTOMATIC LASER LEVEL**



URREA



Content	
Laser level	1
AAA 1.5 V Batteries	2
Mount with 360° swivel arm	1



- Laser Accuracy:  $\pm 0.006''$  / ft
- Working range: 32 ft
- Self leveling: <5 s
- Body protected with rubber anti-skid rubber.
- It has Screw mounts to tripod or base for laser level.
- Function lock switch.



ITEM	DESCRIPTION	AVAILABILITY
NL2	2 Lines semi-automatic laser level	1 ✓

**LINE AND POINT LASER LEVEL**



URREA



Content	
Laser level	1
AAA 1.5 V Batteries	2
Mounting base	1

- Laser accuracy:
- Line  $\pm 0.012''$  / ft
- point  $\pm 0.006''$  / ft
- Working range:
- Line 9 ft
- point 65 ft
- Magnetic base for mounting the laser to a wall or tripod.



ITEM	DESCRIPTION	AVAILABILITY
NL1	Line and point laser level	1 ✓

**2 LINES LASER LEVEL FOR TILE**



URREA



CONTENT	
1	Laser level
2	AA 1.5 V Batteries



- Laser accuracy:  $\pm 0.006''$  / ft
- Working range: 23 ft
- Angle of lines: 90°
- Ideal for installation of floors, tiles, etc.
- Body protected with anti-skid rubber.
- Operation switch.
- Fast and precise alignment for 2 laser lines with 90° angle.



ITEM	DESCRIPTION	AVAILABILITY
NL2E	2 Lines laser level for tiles	1 ✓

**BASE FOR LASER LEVEL**



URREA



- Additional elevation 31 1/2"
- Compatible with laser levels with 1/4" thread (all Urrea's laser levels).
- Base plate can attach on the metal wall by magnet or attach to a wall by hooking hole.



ITEM	DESCRIPTION	AVAILABILITY
BNL	Base for laser level	1 On Request

DIAGNOSTIC AND MEASURING TOOLS

## CHALK LINES

### CHALK LINE REEL



- Large capacity reservoir holds 20 oz of chalk.
- Steel crank.
- High speed rewind system.
- Cotton braided line.
- 0.13" - 0.15" diameter.



ITEM	YARN LENGTH	CHALK CAPACITY	☞	AVAILABLE
TL50	164 ft / 50 m	21 oz / 600 g	1	✓

### METALLIC CHALK LINE SET



2  
PIECES



- Brake system that is automatically released when rewind.
- Filling system that avoids waste.

ITEM	YARN LENGTH	CHALK CAPACITY	☞	AVAILABLE
130561	104.9 ft / 30 m	4 oz / 113 g	6	On Request

### CHALK REPLACEMENTS



130570



130575

- Filling system that avoids waste.
- Phosphorescent chalks are ideal to mark lines in places of little brightness.
- Extra fine chalk.

**BULK**

ITEM	COLOR	CHALK CAPACITY	☞	AVAILABLE
130570	●	8 oz / 227 g	6	On Request
130575	●	8 oz / 227 g	6	On Request

### CHALK LINE REEL WITH CHALK



2  
PIECES



- Break-resistant and powder absorbent polyester chalk line string.

ITEM	YARN LENGTH	CHALK CAPACITY	☞	AVAILABLE
TL30P	104.9 ft / 30 m	3 oz / 86 g	1	✓

### PLASTIC CHALK LINE SET



3  
PIECES



- Body made of ABS plastic.
- Flip-up handle that is stored after its use.
- Thread made of polyester resistant to breach.
- Includes thread level with acrylic drop.

ITEM	YARN LENGTH	CHALK CAPACITY	☞	AVAILABLE
130562	49.2 ft / 15 m	4 oz / 113 g	6	On Request
130569	104.9 ft / 30 m	4 oz / 113 g	1	On Request

**URREA**  
SUPERIOR QUALITY AFFORDABLE TOOLS

# SUPERIOR Alignment

usa.urrea.com CHALK LINE REEL

DIAGNOSTIC AND MEASURING TOOLS



CLASS	TYPE	PAGE	BRAND	
			URREA	SURTEK
Steel wire rope	Steel wire ropes	446		•
Chains	Chains	446		•
	Swivel chains	447		•
Load accessories	Links	447		•
	Coat hooks	448		•
	Swivel eye pulley	448		•
	Shackles	449		•
	Thimbles	449		•
	Wire rope clips for steel cable	450		•
	Pulleys	451		•
	Steel turnbuckles	452		•
	Load binders	452		•
	Ropes	Polypropylene ropes	453	
Raffia		453		•
Hand truck and hand carts	Drum and dolly carts	454	•	•
	Platform trolleys	454		•
Slings	Slings	457	•	•
	Tie down strap	459	•	•
	Straps and winches	460	•	•
	Bungee cord	460		•
Hydraulics	Lifting table carts	460	•	•
	Hand pallet trucks	461	•	•
Hoists	Electric hoists	463	•	•
	Manual hoist	464	•	•
	Trolley	467	•	•
	Hand pullers	467		•
Casters	Casters	468		•

urrea.com

We are constantly improving our products, that is why the information, characteristics and availability of them can change without prior notice.

## STEEL WIRE ROPES

### STEEL WIRE ROPES WITH THIMBLES



ITEM	CABLE DIAMETER	LENGTH	WORKING LOAD LIMIT	⊞	AVAILABLE
CA112	1/16"	250'	478 lb	1	On Request
CA113	3/32"	250'	919 lb	1	On Request
CA114	1/8"	250'	1,700 lb	1	On Request
CA116	3/16"	250'	3,699 lb	1	On Request
CA118	1/4"	250'	6,098 lb	1	On Request
CA122	1/16"	498'	478 lb	1	On Request
CA123	3/32"	498'	919 lb	1	On Request
CA124	1/8"	498'	1,700 lb	1	On Request
CA132	1/16"	1,476'	478 lb	1	On Request
CA134	1/8"	1,476'	1,700 lb	1	On Request



CA112

•Made of alloy steel with galvanized finish.

## CHAINS

### DOUBLE LOOP STEEL CHAIN



Features	Length	Width	Working load capacity
150836	98'	1-9/16"	90 lb
150837	98'	2"	115 lb
150838	98'	3-1/2"	198 lb
150839	98'	4-1/2"	254 lb
150840	98'	6-1/2"	264 lb



ITEM	WIRE DIAMETER	⊞	AVAILABLE
150836	1/16"	1	On Request
150837	3/32"	1	On Request
150838	1/8"	1	On Request
150839	1/8"	1	On Request
150840	5/32"	1	On Request



•Made of carbon steel with galvanized finish.

### GRADE 30 POLISH STEEL CHAINS



Features	Wire diameter	Link length	Link width	Load capacity	Weight per linear meter
	1/8"	29/32"	9/32"	397 lb	0.62 lb
	3/16"	1-1/32"	11/32"	805 lb	0.95 lb
	1/4"	1-1/16"	13/32"	1,279 lb	1.81 lb
	5/16"	1-7/32"	17/32"	1,896 lb	2.93 lb
	3/8"	1-9/32"	19/32"	2,646 lb	4.37 lb
	1/2"	1-9/16"	11/16"	4,475 lb	7.94 lb



ITEM	WIRE DIAMETER	LENGTH	WORKING LOAD CAPACITY KG	LB	⊞	AVAILABLE
<b>Polish steel chains, 110 lb bucket</b>						
150860	3/16"	381'	365	804	1	✓
150861	1/4"	200'	580	1,278	1	✓
150862	5/16"	123'	860	1,895	1	✓
150863	3/8"	83'	1,200	2,644	1	✓
150864	1/2"	45'	2,030	4,473	1	✓
<b>Polish steel chains, 55 lb</b>						
150857	1/8"	293'	180	396	1	✓
150858	3/16"	193'	365	804	1	On Request
150859	1/4"	100'	580	1,278	1	✓



- Durable carbon steel construction.
- Suitable for a wide range of general-purpose applications.
- Not designed or certified for vertical lifting.
- Electro-welded links for added strength.
- Important: no anti-rust coating. Susceptible to corrosion in coastal or high-humidity environments.



## CHAINS

### GRADE 30 GALVANIZED STEEL CHAINS



Wire diameter	Link length	Link width	Load capacity	Weight per linear meter
1/8"	29/32"	9/32"	397 lb	0.28 kg
3/16"	1-1/32"	11/32"	805 lb	0.43 kg
1/4"	1-1/16"	13/32"	1,279 lb	0.82 kg
5/16"	1-7/32"	17/32"	1,896 lb	1.33 kg
3/8"	1-9/32"	19/32"	2,646 lb	1.98 kg
1/2"	1-9/16"	11/16"	4,475 lb	3.6 kg



ITEM	WIRE DIAMETER	LENGTH	WORKING LOAD CAPACITY		⊞	AVAILABLE
			KG	LB		
<b>Galvanized steel chains, 110 lb bucket</b>						
150850	3/16"	381'	365	804	1	✓
150851	1/4"	200'	580	1,278	1	✓
150852	5/16"	123'	860	1,895	1	✓
150853	3/8"	83'	1,200	2,644	1	✓
150854	1/2"	45'	2,030	4,473	1	✓
<b>Galvanized steel chains, 55 lb bucket</b>						
150847	1/8"	293'	180	396	1	✓
150848	3/16"	193'	365	804	1	✓
150849	1/4"	100'	580	1,278	1	✓

- Durable carbon steel construction.
- Suitable for a wide range of general-purpose applications.
- Not designed or certified for vertical lifting.
- Electro-welded links for added strength.

### SWIVEL CHAINS

#### SWIVEL CHAINS



DES9

- High-strength forged steel.
- Hot-dip galvanized finish for superior corrosion resistance.
- Design prevents twisting under load, ensuring safer operation.
- Always respect the working load limit for maximum safety.



ITEM	SIZE	MAXIMUM LOAD LIMIT	⊞	AVAILABLE
DES3	1/4"	860 lb	10	✓
DES4	5/16"	1,257 lb	10	On Request
DES5	3/8"	2,249 lb	10	On Request
DES7	1/2"	3,594 lb	4	On Request
DES9	5/8"	5,203 lb	4	✓

### LINKS

#### CHAIN QUICK LINKS



151520

- Strong carbon steel construction.
- Zinc-plated finish for added durability and corrosion resistance.
- Perfect for towing, securing, and anchoring applications.
- Features a threaded locking pin for fast, reliable connection to chains, wire ropes, and other accessories.



ITEM	SIZE	LENGTH	MAXIMUM LOAD LIMIT	⊞	AVAILABLE
151520	1/8"	1-1/2"	220 lb	12	On Request
151521	3/16"	2"	661 lb	12	On Request
151522	1/4"	2-1/2"	882 lb	12	On Request
151523	5/16"	3"	1,764 lb	12	On Request
151524	3/8"	3-1/2"	2,646 lb	12	On Request
151525	1/2"	4"	3,307 lb	12	On Request

### SPRING SNAP LINK



151500



ITEM	SIZE	⊞	AVAILABLE
151500	19-11/16"	12	On Request
151501	23-5/8"	12	On Request
151502	27-9/16"	12	On Request
151503	31-1/2"	12	On Request



CARGO HANDLING

## HOOKS

### ! IMPORTANT SAFETY INFORMATION:

1. Always visually inspect the hook before using it.
2. Never use a hook whose throat opening has been increased or whose tip has been bent more than 10° out of the plane of the hook body or if it is in any other way distorted or bent.
3. Remove any cracked hook from service, notches or edges.
4. Never repair, rework, alter, or shape a weld-based hook, heating it or folding it.

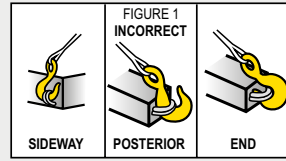

5. Never load from the side, the back or the tip of a hook (fig. 1).

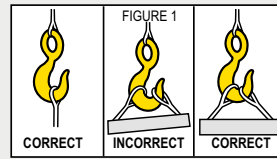

6. Always make sure the hook supports correctly the load (fig. 2).

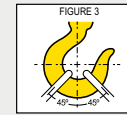

7. When you put 2 sling arms on one hook, make sure the angle of the vertical arm is not greater than 45° and that the angle between two arms do not exceed 90° (fig 3). For angles greater than 90° or slings with more than two arms a master link or shackle should be used to tie the arms of the sling or hook.

### STEEL FORGED HOOKS

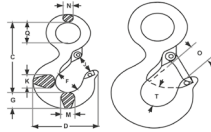

GAN02

- Equipped with a heavy-duty spring safety latch that securely holds the load and prevents accidental release.
- Eye hooks with latch are rated and classified by load capacity for reliable performance.
- Forged carbon steel construction ensures strength and durability.
- Designed for safe use with steel wire rope.



ITEM	SIZE	MAXIMUM LOAD LIMIT	DIMENSIONS (INCHES)											☑	AVAILABLE
			C	D	F	G	J	K	M	N	O	Q	T		
GAN01	3/4"	1,653 lb	3.34	2.86	1.25	0.73	0.9	0.69	0.63	0.36	0.89	0.75	0.87	1	On Request
GAN02	7/8"	2,205 lb	3.81	3.11	1.38	0.84	0.93	0.71	0.71	0.42	0.91	0.91	0.98	1	On Request
GAN03	1-1/8"	3,307 lb	4.24	3.55	1.5	1	0.99	0.88	0.88	0.55	1	1.13	1.03	1	On Request
GAN04	1-1/4"	4,409 lb	4.84	3.97	1.63	1.13	1.15	0.94	0.94	0.58	1.09	1.29	1.16	1	On Request
GAN05	1-9/16"	6,614 lb	5.91	4.87	2	1.44	1.52	1.31	1.31	0.72	1.36	1.56	1.53	1	On Request
GAN06	2"	11,023 lb	7.51	6.27	2.5	1.81	1.75	1.66	1.66	0.9	1.61	2.03	1.96	1	On Request
GAN07	2-7/16"	16,535 lb	9.16	7.5	3	2.25	2.41	1.88	1.63	1.11	2.08	2.44	2.47	1	On Request

### CLEVIS GRAB HOOKS

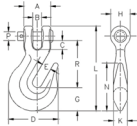

GANCC3

- Eye hooks are rated and classified by load capacity for reliable performance.
- Forged carbon steel construction ensures strength and durability.
- Designed for safe use with steel wire rope.



ITEM	SIZE	MAXIMUM LOAD LIMIT	DIMENSIONS (INCHES)											☑	AVAILABLE	
			A	B	C	D	E	G	H	K	L	N	P			P
GANCC1	1/4"	2,599 lb	1	0.32	0.31	1.81	0.34	0.88	0.72	0.47	3.05	1.75	0.31	1.64	1	On Request
GANCC2	5/16"	2,875 lb	1.22	0.43	0.36	2.12	0.44	0.97	0.91	0.59	3.66	2.06	0.38	2.02	1	On Request
GANCC3	3/8"	5,399 lb	1.42	0.48	0.49	2.53	0.5	1.17	1	0.72	4.42	2.34	0.44	2.41	1	On Request
GANCC4	1/2"	9,200 lb	1.88	0.57	0.51	3.56	0.66	1.53	1.25	0.78	5.72	2.97	0.63	3.19	1	On Request
GANCC5	5/8"	13,001 lb	2.31	0.71	0.67	4.39	0.78	1.78	1.56	1.09	6.83	4.31	0.75	4.09	1	On Request

### "S" TYPE HOOKS



GANS4

- S-hooks forged from durable carbon steel.
- Galvanized finish for corrosion resistance and extended service life.



ITEM	SIZE	MAXIMUM LOAD LIMIT	☑	AVAILABLE
GANS3	3/16"	28,7 lb	12	On Request
GANS4	1/4"	83,8 lb	12	On Request
GANS5	5/16"	165,3 lb	12	On Request

### SWIVEL EYE PULLEY

#### SWIVEL EYE PULLEY



151035

- Heavy-duty zinc pulley for load handling in construction and industrial applications.
- Designed to facilitate lifting and guiding of loads safely and efficiently.
- Nickel-plated finish for enhanced durability and corrosion resistance.



ITEM	SIZE	MAXIMUM LOAD LIMIT	☑	AVAILABLE
151035	3/4"	110 lb	12	On Request
151036	1"	110 lb	12	On Request
151037	1-1/2"	165,3 lb	12	On Request
151038	2"	198 lb	12	On Request

**SHACKLES**

**STEEL FORGED SHACKLES**



**GRI1**

- Forged and heat-treated for maximum strength and durability.
- Hot-dip galvanized finish for superior corrosion resistance.
- Electrostatic-coated pin adds extra protection against rust.
- Suitable for tie-downs, towing, suspensions, and lifting applications, whether under straight-line or side load.
- Ideal choice for permanent or long-term installations.



ITEM	SIZE		MAXIMUM LOAD LIMIT	WITH BOLT-NUT	⊞	AVAILABLE
<b>GRI1</b>	4.7 mm	3/16"	661 lb	–	5	On Request
<b>GRI2</b>	6.3 mm	1/4"	992 lb	–	5	On Request
<b>GRI3</b>	7.9 mm	5/16"	1,499 lb	–	5	On Request
<b>GRI4</b>	9.5 mm	3/8"	2,006 lb	–	5	On Request
<b>GRI5</b>	11.1 mm	7/16"	2,998 lb	–	5	On Request
<b>GRI6</b>	12.7 mm	1/2"	3,990 lb	–	5	On Request
<b>GRI7</b>	15.8 mm	5/8"	6,504 lb	–	5	On Request
<b>GRI8</b>	19 mm	3/4"	9,502 lb	–	5	On Request
<b>GRI9</b>	22.2 mm	7/8"	14,110 lb	–	5	On Request
<b>GRI10</b>	25.4 mm	1"	18,298 lb	–	3	On Request
<b>GRI11</b>	28.5 mm	1-1/8"	20,723 lb	–	3	On Request
<b>GRI12</b>	31.7 mm	1-1/4"	26,455 lb	–	1	On Request
<b>GRI13</b>	34.9 mm	1-3/8"	29,652 lb	–	1	On Request
<b>GRI14</b>	38.1 mm	1-1/2"	37,258 lb	–	1	On Request

**STEEL FORGED SHACKLES**



**GCH3**

With security bolt-nut

- Forged and heat-treated for maximum strength and durability.
- Hot-dip galvanized finish for superior corrosion resistance.
- Electrostatic-coated pin adds extra protection against rust.
- Suitable for tie-downs, towing, suspensions, and lifting applications, whether under straight-line or side load.
- Ideal choice for permanent or long-term installations.
- Equipped with a secure cotter pin safety lock for added reliability.



ITEM	SIZE		MAXIMUM LOAD LIMIT	WITH BOLT-NUT	⊞	AVAILABLE
<b>GCH3</b>	1/2"	12.7 mm	3,990 lb	•	5	On Request
<b>GCH4</b>	5/8"	15.8 mm	6,503 lb	•	5	On Request
<b>GCH5</b>	3/4"	19 mm	9,501 lb	•	5	On Request
<b>GCH6</b>	7/8"	22.2 mm	14,109 lb	•	5	On Request
<b>GCH7</b>	1"	25.4 mm	18,298 lb	•	3	On Request

**THIMBLES**

**WIRE ROPE THIMBLES**



**GC5**

- Steel thimbles with a durable galvanized finish for corrosion resistance.
- Oval design makes fastening loads easier and more secure.
- Prevents wire rope wear and deformation by ensuring the proper bend at eye terminals.
- Extends the service life and safety of wire rope assemblies.



ITEM	CABLE DIAMETER	⊞	AVAILABLE
<b>GC3</b>	1/4"	12	On Request
<b>GC5</b>	3/8"	12	On Request
<b>GC6</b>	1/2"	12	On Request
<b>GC7</b>	5/8"	5	On Request
<b>GC8</b>	3/4"	5	On Request

## WIRE ROPE CLIPS

### WIRE ROPE CLIPS INSTALLATION METHOD:

1. Run the necessary cable length around the thimble, and install the first wire rope cable at a distance equal to the width of its base from the tip cable end. Tighten the nuts alternately to the specified torque.

2. When only 2 wire rope cables are needed, install as close to the cable or thimble fold as possible, and alternately tighten the nuts up to the specified torque. When more than 2 wire rope cables are required install the second one as close to the cable or thimble fold as possible and turn the nuts firmly without tightening.

3. Install all the wire rope cables that are necessary between the first 2 with equal spaces between each other and located in the same position. Make sure that the nuts of all wire rope cables are tightened according to the specified torque.

4. Finally, apply a load equal to or greater than what you expect to use to test the assembly. Immediately check, and if necessary, retighten the nuts according to the recommended torque.

### CAUTIONS

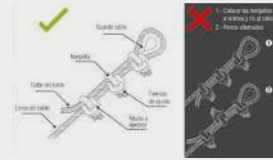

Never use malleable iron wire rope clips to lift loads or on heavy duty. These are used to be wired eye terminals standard and twisted to the right and in non-critical uses applying small loads such as handrails, wiring, etc. Never use wire rope clips to directly join two cables and lift the load. Periodically inspect terminals and wire to identify wear, abuse, or irregularities. The bases and threads must be free and dry of lubricants to achieve the specified torques.

### FORGED WIRE ROPE CLIPS FOR STEEL CABLE



PER3DF

- Heavy-duty forged wire rope clips made of malleable iron.
- Galvanized finish for enhanced corrosion resistance and long service life.
- Equipped with durable steel nuts for secure fastening.
- Designed for demanding applications in lifting, rigging, and load handling.

ITEM	CABLE DIAMETER	THREAD DIAMETER		MINIMUM WIRE ROPE CLIPS pieces	TRAVEL CABLE LENGTH		MINIMUM TORQUE		IDEAL FOR CABLE:		AVAILABLE
		In	mm		In	mm	lb-ft	nm	In		
PER3DF	1/4"	1/4"	7.51	2	4-3/4"	15	20.35	5/16"	5	✓	
PER5DF	3/8"	3/8"	10.67	2	6-1/2"	25	33.92	7/16"	5	✓	

### MALEABLE IRON WIRE ROPE CLIPS FOR STEEL CABLE



PER1

- Wire rope clips made of malleable cast iron.
- Galvanized finish provides protection against corrosion.
- Fitted with steel nuts for secure fastening.
- Reliable and durable solution for general cable fastening applications.

ITEM	CABLE DIAMETER	THREAD DIAMETER		MINIMUM WIRE ROPE CLIPS pieces	TRAVEL CABLE LENGTH		MINIMUM TORQUE		IDEAL FOR CABLE		AVAILABLE
		In	mm		In	mm	lb-ft	nm	In		
PER1	1/8"	3/16"	4.46	3	4-3/4"	2.7	3.66	1/8"	12	On Request	
PER2	3/16"	1/4"	5.95	3	5-1/2"	2.7	3.66	3/16"	12	On Request	
PER3	1/4"	5/16"	7.54	3	7"	12	16.26	1/4"	12	On Request	
PER4	5/16"	5/16"	7.54	3	7-3/4"	12	16.26	5/16"	12	On Request	
PER5	3/8"	3/8"	9.05	3	9-1/2"	18.5	25.07	3/8"	12	On Request	
PER6	7/16"	3/8"	9.05	4	10-1/4"	18.5	25.07	7/16"	12	On Request	
PER7	1/2"	7/16"	10.65	4	14-7/8"	25	33.88	1/2"	12	On Request	
PER8	9/16"	1/2"	11.77	4	16"	35	47.43	9/16"	12	On Request	
PER9	5/8"	1/2"	11.77	4	16"	35	47.43	5/8"	10	On Request	
PER10	3/4"	9/16"	13.36	5	22-1/4"	50	67.75	3/4"	10	On Request	
PER11	7/8"	5/8"	14.98	5	23-1/2"	100	135.5	7/8"	10	On Request	
PER12	1"	5/8"	14.98	6	31"	100	135.5	1"	10	On Request	

### DIN TYPE MALEABLE IRON WIRE ROPE CLIPS FOR STEEL CABLE



PER5A

- DIN type wire rope clips made of malleable iron.
- Galvanized finish for reliable corrosion resistance.
- Equipped with steel nuts for secure fastening.
- Designed for light-duty cable fastening applications.

ITEM	CABLE DIAMETER	THREAD DIAMETER		MINIMUM WIRE ROPE CLIPS pz	TRAVEL CABLE LENGTH		MINIMUM TORQUE		IDEAL FOR CABLE		AVAILABLE
		in	mm		mm	mm	lb-ft	nm	in		
PER1A	1/8"	1/8"	3.55	3	4-3/4"	2.5	3.39	5/32"	12	On Request	
PER3A	1/4"	1/4"	4.75	3	7"	2.7	3.66	3/16"	12	On Request	
PER5A	3/8"	3/8"	7.51	3	9-1/2"	12	16.26	9/32"	12	On Request	
PER7A	1/2"	1/2"	9.54	4	14-7/8"	18.5	25.07	3/8"	12	On Request	
PER9A	5/8"	5/8"	11.58	4	16"	35	47.43	15/32"	10	On Request	
PER10A	3/4"	3/4"	11.58	5	22-1/4"	35	47.43	7/16"	10	On Request	

## PULLEYS

### PULLEYS WITH CABLE HOOK



**SURTEK**  
TOOLS FOR SPECIALISTS



**NEW**

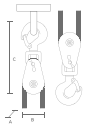

PGA2

- Heavy-duty cable pulley with hook, designed for constant and demanding use.
- High-carbon steel body provides superior strength and hardness.
- Safety factor 4 ensures reliable performance under load.
- Equipped with a 360° swivel cast iron hook for versatile lifting.
- Makes lifting and handling heavy objects safer and easier.

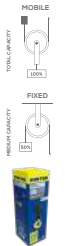

ITEM	MAXIMUM CAPACITY	LENGHT A	WIDTH B	HEIGHT C	CABLE DIAMETER	⊞	AVAILABLE
PGA2	2t	3"	2-1/2"	9-7/8"	1/4-3/8"	1	On Request
PGA4	4t	4"	3-19/32"	14-3/16"	3/8-1/2"	1	On Request
PGA8	8t	6"	4-7/32"	18-5/16"	5/8-1/2"	1	On Request

### SWIVEL PULLEY



**SURTEK**  
TOOLS FOR SPECIALISTS



**NEW**

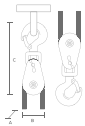

PGS05

- Heavy-duty swivel pulley designed for continuous and demanding use.
- High-carbon steel body delivers superior strength and durability.
- Safety factor 4 ensures reliable and safe lifting performance.
- Equipped with a 360° swivel cast iron hook for greater versatility.
- Makes lifting and handling heavy loads safer and easier.

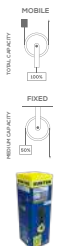

ITEM	MAXIMUM CAPACITY	LENGHT A	WIDTH B	HEIGHT C	CABLE DIAMETER	⊞	AVAILABLE
PGS05	0.5t	3-3/16"	1-3/4"	11"	1/2"	1	On Request
PGS10	1t	3-3/16"	1-3/4"	12-25/32"	5/8"	1	On Request
PGS15	1.5t	5-1/2"	2-3/16"	15-3/4"	3/4"	1	On Request

### DOUBLE SWIVEL PULLEY



**SURTEK**  
TOOLS FOR SPECIALISTS



**NEW**

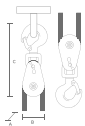

PGD05

- Heavy-duty double swivel pulley built for continuous and demanding use.
- High-carbon steel body provides exceptional strength and durability.
- Safety factor 4 ensures safe and reliable lifting performance.
- Features a 360° swivel cast iron hook for maximum versatility.
- Facilitates safer and easier lifting and handling of heavy loads.

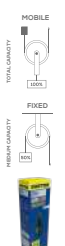

ITEM	MAXIMUM CAPACITY	LENGHT A	WIDTH B	HEIGHT C	CABLE DIAMETER	⊞	AVAILABLE
PGD05	0.5t	3-3/16"	2-11/16"	11"	1/2"	1	On Request
PGD10	1t	3-3/16"	3-1/8"	12-25/32"	5/8"	1	On Request
PGD15	1.5t	5-1/2"	3-1/8"	15-3/4"	3/4"	1	On Request

## TURNBUCKLES

### FORGED STEEL TURNBUCKLES



**SURTEK**  
TOOLS FOR SPECIALISTS



TEN23

- Heavy-duty hook turnbuckles with quenched and tempered body and hot-dip galvanized finish for superior corrosion resistance.
- Built to withstand high tension levels over long periods of use.
- Designed for linear tensioning applications such as power lines, telecommunications, antennas, transportation, and marine industry.
- Threaded connection mechanism ensures precise adjustment, providing secure tensioning or stretching of cables, ropes, wires, and chains.

**BULK**

ITEM	DIAMETER	LENGTH	WORKING LOAD CAPACITY	⊞	AVAILABLE
TEN23	3/8"	3"	705 lb	1	On Request
TEN26	3/8"	6"	705 lb	1	On Request
TEN33	1/2"	3-1/2"	1,036 lb	1	On Request
TEN36	1/2"	6"	1,036 lb	1	On Request
TEN39	1/2"	9"	1,036 lb	1	On Request
TEN46	5/8"	6"	1,609 lb	1	On Request
TEN49	5/8"	9"	1,609 lb	1	On Request
TEN412	5/8"	12"	1,609 lb	1	On Request
TEN56	3/4"	6"	2,006 lb	1	On Request
TEN512	3/4"	12"	2,006 lb	1	On Request
TEN612	7/8"	12"	3,938 lb	1	On Request
TEN712	1"	12"	4,960 lb	1	On Request
TEN718	1"	18"	4,960 lb	1	On Request

### ZINC ALLOW TURNBUCKLES



**SURTEK**  
TOOLS FOR SPECIALISTS



151530

- Strong zinc body designed to withstand tension.
- Galvanized coating provides reliable corrosion protection and extended service life.
- Always respect the working load limit to ensure safe operation.



ITEM	DIAMETER	LENGTH	WORKING LOAD CAPACITY	⊞	AVAILABLE
151530	3/16"	1-5/8"	90 lb	1	On Request
151531	1/4"	2-3/8"	110 lb	1	On Request
151532	5/16"	2-3/4"	243 lb	1	On Request
151533	3/8"	3"	441 lb	1	On Request

### ZINC ALLOW TURNBUCKLES



**SURTEK**  
TOOLS FOR SPECIALISTS



151535

- Strong zinc body designed to withstand tension.
- Galvanized coating provides reliable corrosion protection and extended service life.
- Always respect the working load limit to ensure safe operation.



ITEM	DIAMETER	LENGTH	WORKING LOAD CAPACITY	⊞	AVAILABLE
151535	3/16"	1-5/8"	90 lb	1	On Request
151536	1/4"	2-3/8"	110 lb	1	On Request
151537	5/16"	2-3/4"	243 lb	1	On Request
151538	3/8"	3"	441 lb	1	On Request

### LOAD BINDERS



**SURTEK**  
TOOLS FOR SPECIALISTS



GAT5M

GAT3

- Heavy-duty chain binders with ball-and-socket swivel hook assemblies for precise straight-line pulling.
- One-piece forged handle and assembly for maximum strength and reliability.
- Reinforced leverage point prevents deformation under heavy loads.
- Designed for secure fastening, with easy release from the opposite side of the load.



**CAUTION:**

- Do not exceed the load limit.
- Move the handle with **caution**, as you could hit it. Stand clear of the path of movement of the handle.
- Do not operate the chain tensioner when standing on the load.
- While under tension, the chain tensioner or jack must not support any objects.



ITEM	CHAIN SIZE	WORKING LOAD CAPACITY	⊞	AVAILABLE
<b>With ratchet</b>				
GAT5M	5/16" - 3/8"	5,401 lb	1	On Request
GAT7M	3/8" - 1/2"	9,200 lb	1	On Request
GAT9M	1/2" - 5/8"	13,007 lb	1	On Request
<b>With lever</b>				
GAT3	1/4" - 5/16"	2,200 lb	1	On Request
GAT5	5/16" - 3/8"	5,401 lb	1	On Request
GAT7	3/8" - 1/2"	9,200 lb	1	On Request
GAT9	1/2" - 5/8"	11,001 lb	1	On Request

**POLYPROPYLENE ROPES**

**POLYPROPYLENE ROPES WITH REEL**



- Two-tone twist: Blue and yellow, starting at 6 mm gauge

- Durable polypropylene rope designed for versatile applications.
- Waterproof and resistant to mold, mildew, and rot, ensuring long-lasting performance.
- Stronger and more reliable than ropes made from natural fibers.
- Roll weight tolerance of +/-5% for consistent quality and performance.



ITEM	ROPE DIAMETER	WEIGHT FEET PER LB	FT PER REEL	WEIGHT PER REEL	☞	AVAILABLE
138200	5/32"	157 ft/lb	3,445'	22 lb	1	✓
138201	1/4"	79 ft/lb	3,825'	49 lb	1	✓
138202	5/16"	51 ft/lb	2,454'	49 lb	1	✓
138203	13/32"	34 ft/lb	2,037'	60 lb	1	✓
138204	7/16"	22 ft/lb	1,329'	60 lb	1	✓
138205	1/2"	19 ft/lb	1,322'	68 lb	1	✓
138206	5/8"	12 ft/lb	1,050'	88 lb	1	✓
138207	3/4"	9 ft/lb	787'	88 lb	1	✓

**GRAY POLYPROPYLENE ROPES WITH REEL**



- Eco-friendly rope made from recycled polypropylene.
- Waterproof and resistant to mold, mildew, and rot for long-lasting performance.
- Stronger than natural fiber ropes, offering greater durability and reliability.
- Roll weight tolerance of +/-5% ensures consistent quality.



ITEM	ROPE DIAMETER	WEIGHT FEET PER LB	FT PER REEL	WEIGHT PER REEL	☞	AVAILABLE
CUEP4	5/32"	164 ft/lb	3,248'	22 lb	1	✓
CUEP6	1/4"	79 ft/lb	3,563'	49 lb	1	✓
CUEP8	5/16"	51 ft/lb	2,287'	49 lb	1	✓
CUEP10	13/32"	36 ft/lb	2,001'	60 lb	1	✓
CUEP13	1/2"	19 ft/lb	1,250'	68 lb	1	✓

**RAFFIA**

**POLYPROPYLENE RAFFIA**



- Polypropylene raffia with high tensile strength for demanding applications.
- Resistant to mold, mildew, and decay for long-lasting use.
- Stronger and more durable than natural fiber ropes.



ITEM	GAUGE	WEIGHT	COLOR	☞	AVAILABLE
RFB45	2.2 g/m	4.5 kg	White	1	✓
RFB09	2.2 g/m	900 g	White	1	✓
RFB05	2.2 g/m	500 g	White	6	✓

## PLATFORM CARTS



Detachable handles made of 1" tube.



Polyurethane casters fixed on the reinforced base, offers greater support and load capacity, avoiding the deformation of the steel sheet.



Base covered with 16 gauge steel sheet, thanks to its design, it prevents loads from landsliding.

### PLATFORM TRUCK



**2204 LB**  
TOTAL LOAD CAPACITY



26021

- Equipped with front swivel casters for smooth maneuverability.
- Rear fixed wheels provide stability and straight tracking.

**BULK**

ITEM	CAPACITY	HEIGHT	WIDTH	LENGTH	CASTERS	☐	AVAILABLE
26021	2204.6 lb	3.14 ft	1.96 ft	4 ft	6"	1	✓
26023	2204.6 lb	3.34 ft	3.34 ft	4.98 ft	8"	1	✓

### PLATFORM TROLLEY WITH RETRACTABLE HANDLE



**661 LB**  
TOTAL LOAD CAPACITY



**NEW**



- Retractable handle for compact storage and easy transport.
- Reinforced metal edge with protective plastic coating against impacts.
- High-quality TPR wheel ensures smooth operation and long-lasting durability.



ITEM	CAPACITY	LENGTH	WIDTH	HEIGHT	CASTERS	☐	AVAILABLE
CPL30	661 kg	36"	24.2"	7.8"	5"	1	On Request

## STEEL DRUM DOLLIES AND HANDCARTS

### STEEL DRUM DOLLIES



**1 000 LB**  
TOTAL LOAD CAPACITY



CTM30

- Heavy-duty drum dollies designed for stable handling of barrels, drums, and containers, even under heavy loads.
- Strong steel construction with four PP wheels for superior support and load capacity.
- Convenient pull handle allows easy maneuvering and transport.



ITEM	LOADING CAPACITY	FOR DRUMS OF	DIAMETER	WHEEL SIZE	☐	AVAILABLE
CTM30	1000 Lb	30 gal	19 - 7/8"	2-1/2" x 1-1/2"	1	✓
CTM55	1000 Lb	55 gal	24 - 1/4"	2-1/2" x 1-1/2"	1	✓

### HANDCARTS FOR DRUMS



**1 102 LB**  
TOTAL LOAD CAPACITY



- Heavy-duty drum truck designed to make emptying drum contents easier, holding the drum securely in a horizontal position.
- Equipped with two main 10" wheels with durable aluminum rims.
- Includes two 6" rear wheels for added stability and maneuverability.

**BULK**

ITEM	CAPACITY	HEIGHT	WIDTH	☐	AVAILABLE
26031	500 kg	148 cm	50 cm	1	On Request



**STEEL DRUM DOLLIES AND HANDCARTS**

**HANDCART FOR DRUMS**

**URREA**  
Strong Built. Protected Plus.



**661 LB**  
TOTAL LOAD CAPACITY



- Mobile drum lifter designed to securely hold drums while adapting to different heights.



- One-piece grip supports crafted from 1" cold-bent steel plate for superior strength and durability.

- Strong steel construction with protective painted finish for corrosion resistance.
- Solid rubber wheels deliver superior support and increased load capacity.
- Improved ergonomic grip ensures a firm and secure handling experience.



**BULK**

ITEM	CAPACITY	HEIGHT	WIDTH	☞	AVAILABLE
26030	300 kg	110 cm	42 cm	1	✓

**2 IN 1 ALUMINIUM CONVERTIBLE HANDCART**

**URREA**  
Strong Built. Protected Plus.



**ALUMINIUM**



**500 LB**  
TOTAL LOAD CAPACITY

**Handcart**

- Equipped with two 10" pneumatic wheels that provide excellent shock absorption and smooth transport, even over uneven surfaces.



- Equipped with two 5" TPR wheels for smooth, quiet movement and long-lasting durability.



**Handcart**

**800 LB**  
TOTAL LOAD CAPACITY

**Platform**



**Platform**

- Multi-position aluminum hand truck designed for maximum stability, even with heavy loads.
- Quick-convert design allows fast transformation from upright hand truck to flat platform for versatile load handling



ITEM	CAPACITY	HEIGHT	WIDTH	LENGTH	☞	AVAILABLE	
HT21	<b>Measurement of handcart</b>					1	On Request
	500 lb	7-1/2"	18"	61-1/2"			
	<b>Measurement of platform</b>						
	800 lb	12"	12"	57"			

**WAREHOUSE HAND TRUCK.**

**URREA**  
Strong Built. Protected Plus.



**1543 LB**  
TOTAL LOAD CAPACITY



- Handles reinforced with angled support to prevent bending or fractures, ensuring greater strength and durability.



- Durable 10" vulcanized rubber wheels with lightweight aluminum rims, offering strength, stability, and smooth mobility.



- Heavy-duty platform made of 3/16" steel plate, delivering superior load capacity and durability.



- Reinforced crossbars made of 3/16" x 1/4" flat steel bar for added strength and durability.



**26001**

**BULK**

ITEM	CAPACITY	TIRE TYPE	OUTER DIAMETER A	BASE LENGTH B	BASE WIDTH C	TOTAL HEIGHT D	☞	AVAILABLE
26001	1,543 lb	10" solid	1-1/4"	18.8"	16.9"	54.7"	1	On Request

## STEEL DRUM DOLLIES AND HANDCARTS

### BEVERAGE DELIVERY HAND TRUCKS



- 120° tilt design for easier and safer load handling.
- Equipped with a tire protector to reduce wear during transport.
- Ergonomic non-slip grip handles for secure control.
- Solid threaded axle with safety nuts ensures durability and reliability.
- Built with tubular handles and reinforced flat bar structure for maximum strength and resistance



**SURTEK**  
TOOLS FOR SPECIALISTS



**NEW**

8" solid tyre



10" pneumatic tyre

**BULK**

ITEM	CAPACITY	TIRE TYPE	OUTER DIAMETER A	BASE LENGTH B	BASE WIDTH C	TOTAL HEIGHT D	⊞	AVAILABLE
DRS1	220 lb	6" solid	1"	12.9"	11.8"	55.1"	1	✓
DRS200	440 lb	8" solid	1-1/16"	13.3"	16.9"	55.1"	1	✓
DRS300	661 lb	8" solid	1-1/16"	13.3"	16.9"	55.1"	1	✓
DRS400	881 lb	8" solid	1-5/16"	13.3"	16.9"	55.1"	1	✓
DRN200	440 lb	10" Pneumatic	1-5/16"	13.3"	16.9"	47.2"	1	✓

### GAS CYLINDER HAND TRUCKS.



- Ergonomic handles with non-slip grip for safe and comfortable operation.
- Equipped with safety chains to securely hold gas cylinders during transport.
- Built with tubular handles and reinforced flat bar structure for superior strength.
- Solid threaded axle with stop and safety nuts ensures durability and reliability.
- Perfect for handling and transporting cylinders used with oxy-fuel cutting and welding equipment.



**SURTEK**  
TOOLS FOR SPECIALISTS



**NEW**



DG2C  
7" solid tyre



DGN2C  
16" pneumatic tyre

**BULK**

ITEM	CAPACITY	TIRE TYPE	OUTER DIAMETER A	BASE LENGTH B	BASE WIDTH C	TOTAL HEIGHT D	⊞	AVAILABLE
DG2C	2 cylinders	7" solid	1-5/16"	13.3"	22.8"	55"	1	✓
DGN2C	2 cylinders	16" Pneumatic	1-5/16"	13.3"	22.8"	55"	1	✓

### WAREHOUSE HAND TRUCKS



- 120° tilt design for easier and safer load handling.
- Equipped with a tire protector to reduce wear during transport.
- Ergonomic non-slip grip handles for secure control.
- Solid threaded axle with safety nuts ensures durability and reliability.
- Built with tubular handles and reinforced flat bar structure for maximum strength and resistance



DBS400

DBS400A

DBS400R

**SURTEK**  
TOOLS FOR SPECIALISTS



**NEW**



solid tyre

**BULK**

ITEM	CAPACITY	TIRE TYPE	OUTER DIAMETER A	BASE LENGTH B	BASE WIDTH C	TOTAL HEIGHT D	COLOR	⊞	AVAILABLE
DBS1	220 lb	6" solid	1"	12.9"	11.8"	47.2"	●	1	✓
DBS200	440 lb	8" solid	1-1/16"	13.3"	16.9"	47.2"	●	1	✓
DBS300	661 lb	8" solid	1-1/16"	13.3"	16.9"	47.2"	●	1	✓
DBS400	881 lb	8" solid	1-5/16"	13.3"	16.9"	55"	●	1	✓
DBS400A	881 lb	8" solid	1-5/16"	13.3"	16.9"	55"	●	1	✓
DBS400R	881 lb	8" solid	1-5/16"	13.3"	16.9"	55"	●	1	✓

**SLINGS**

**POLYESTER ENDLESS ROUND SLINGS**



URREA



ER11



ER21



ER33



ER63



ER74



ER95



ER116

- Endless round slings manufactured from high-tenacity polyester with UV-resistant coating.
- Excellent resistance to abrasion and most acids for long-lasting durability.
- Color-coded system makes it easy to identify load capacity at a glance.
- Gentle on loads—will not scratch or damage the surface.
- Meets WSTDA RS-1, RS-2, and TH-1 standards for safety and reliability.



ITEM	BELT WIDTH	LENGTH	LOAD CAPACITY			COLOR	⊕	AVAILABLE	
			LBS VERTICAL	LBS LINKED	LBS BASKET "U"				
ER11	19/32"	3,3 ft	2,599	2,078	5,200	4,499	3,600	1	✓
ER12	19/32"	6,6 ft	2,599	2,078	5,200	4,499	3,600	1	✓
ER13	19/32"	9,8 ft	2,599	2,078	5,200	4,499	3,600	1	✓
ER21	13/16"	3,3 ft	5,299	4,259	9,717	9,100	7,841	1	✓
ER22	13/16"	6,6 ft	5,299	4,259	9,717	9,100	7,841	1	✓
ER23	13/16"	9,8 ft	5,299	4,259	9,717	9,100	7,841	1	✓
ER33	1"	9,8 ft	8,399	6,719	16,799	14,499	11,800	1	✓
ER34	1"	13 ft	8,399	6,719	16,799	14,499	11,800	1	On Request
ER35	1"	16 ft	8,399	6,719	16,799	14,499	11,800	1	On Request
ER36	1"	20 ft	8,399	6,719	16,799	14,499	11,800	1	On Request
ER63	1-5/16"	9,8 ft	13,199	10,600	4,354	22,800	18,600	1	On Request
ER64	1-5/16"	13 ft	13,199	10,600	4,354	22,800	18,600	1	On Request
ER66	1-5/16"	20 ft	13,199	10,600	4,354	22,800	18,600	1	On Request
ER74	1-13/32"	13 ft	16,799	13,620	33,600	27,500	22,500	1	On Request
ER76	1-13/32"	20 ft	16,799	13,620	33,600	27,500	22,500	1	On Request
ER78	1-13/32"	26 ft	16,799	13,620	33,600	27,500	22,500	1	On Request
ER95	1-9/16"	16 ft	21,199	17,000	42,400	36,700	29,900	1	On Request
ER97	1-9/16"	23 ft	21,199	17,000	42,400	36,700	29,900	1	On Request
ER116	1-3/4"	20 ft	25,000	20,000	50,000	43,300	35,274	1	On Request
ER118	1-3/4"	26 ft	25,000	20,000	50,000	43,300	35,274	1	On Request

CARGO HANDLING

**ENDLESS ROUND SLING**

**CAUTIONS**

Recommended for use in pairs to ensure stability and safety.

Always respect the rated load capacities.

Manufactured in compliance with ASME B30.9-2010 standard for lifting slings.

Designed with a safety factor of 5:1 — the maximum breaking strength is five times the rated working load limit of the assembly.



**RATED CAPACITY**

SLING WIDTH	COLOR	RATED CAPACITY				
		VERTICAL	CHOKER	VERTICAL BASKET	60°	45°
0.6 in	●	2,599 lb	2,078 lb	5,200 lb	4,499 lb	3,600 lb
0.8 in	●	5,299 lb	4,199 lb	9,717 lb	9,100 lb	7,841 lb
1 in	●	8,339 lb	6,719 lb	16,799 lb	14,499 lb	11,799 lb
1.3 in	●	13,199 lb	10,599 lb	26,400 lb	10,342 kg	18,600 lb
1.4 in	●	16,799 lb	13,620 lb	33,609 lb	27,500 lb	22,500 lb
1.5 in	●	21,199 lb	16,999 lb	42,399 lb	63,700 lb	29,899 lb
1.75 in	●	25,000 lb	20,000 lb	50,000 lb	43,300 lb	35,300 lb

## SLINGS

### POLYESTER FLAT EYE & EYE SLING



URREA



- Manufactured from 100% high-strength polyester with UV protection for outdoor durability.
- Withstands temperatures from -40° to 95°C with elongation of only 3% – 5%.
- Red webbing for easy identification of capacity and application.
- Meets international safety standards: ASME B30.9, WSTDA WS-1, WS-2, TH-1.
- Flat eye-to-eye design makes these the most commonly used slings. Load capacity varies depending on the number of plies and configuration of use (vertical, choker, basket, 45°, 60°).



EP213



ITEM	BELT WIDTH	LENGHT	LOAD CAPACITY					☐	AVAILABLE	
			LBS. VERTICAL	LBS. LINKED	LBS. BASKET "U"	LBS. BASKET 60°	LBS. BASKET 45°			LBS. BASKET 30°
<b>2 capas</b>										
EP211	1"	3.28 ft	3200.21	2558.84	6400.42	5540.86	4524.81	3200.21	1	✓
EP212	1"	6.56 ft	3200.21	2558.84	6400.42	5540.86	4524.81	3200.21	1	✓
EP213	1"	9.84 ft	3200.21	2558.84	6400.42	5540.86	4524.81	3200.21	1	✓
EP214	1"	13 ft	3,201	2,559	6,402	5,542	4,526	3,201	1	On Request
EP215	1"	16 ft	3,201	2,559	6,402	5,542	4,526	3,201	1	On Request
EP216	1"	20 ft	3,201	2,559	6,402	5,542	4,526	3,201	1	On Request
EP222	2"	6.56 ft	6400.42	5119.89	12800.83	11083.92	9049.62	6400.42	1	✓
EP223	2"	9.8 ft	6,402	5,121	12,804	11,089	9,054	6,402	1	✓
EP224	2"	13.12 ft	6400.42	5119.89	12800.83	11083.92	9049.62	6400.42	1	✓
EP225	2"	16.40 ft	6400.42	5119.89	12800.83	11083.92	9049.62	6400.42	1	✓
EP226	2"	19.68 ft	6400.42	5119.89	12800.83	11083.92	9049.62	6400.42	1	✓
EP228	2"	26.25 ft	6400.42	5119.89	12800.83	11083.92	9049.62	6400.42	1	✓
EP2210	2"	32.81 ft	6400.42	5119.89	12800.83	11083.92	9049.62	6400.42	1	✓
EP232	3"	6.6 ft	8,803	7,041	17,603	15,247	12,447	8,800	1	On Request
EP233	3"	9.8 ft	8,803	7,041	17,603	15,247	12,447	8,800	1	On Request
EP234	3"	13.12 ft	8798.37	7039.58	17598.94	15240.66	12443.78	8798.37	1	On Request
EP236	3"	19.68 ft	8798.37	7039.58	17598.94	15240.66	12443.78	8798.37	1	On Request
EP238	3"	26.24 ft	8798.37	7039.58	17598.94	15240.66	12443.78	8798.37	1	✓
EP2310	3"	32.81 ft	8798.37	7039.58	17598.94	15240.66	12443.78	8798.37	1	✓
EP242	4"	6.6 ft	11,208	8,961	22,405	19,402	15,842	11,201	1	On Request
EP243	4"	9.8 ft	11,208	8,961	22,405	19,402	15,842	11,201	1	On Request
EP244	4"	13.12 ft	11198.52	8959.26	22399.25	19397.4	15837.94	11198.52	1	On Request
EP245	4"	16.40 ft	11198.52	8959.26	22399.25	19397.4	15837.94	11198.52	1	✓
EP246	4"	19.68 ft	11198.52	8959.26	22399.25	19397.4	15837.94	11198.52	1	On Request
EP247	4"	22.96 ft	11198.52	8959.26	22399.25	19397.4	15837.94	11198.52	1	✓
EP248	4"	26.24 ft	11198.52	8959.26	22399.25	19397.4	15837.94	11198.52	6	On Request
EP249	4"	29.52 ft	11198.52	8959.26	22399.25	19397.4	15837.94	11198.52	6	✓
EP2410	4"	32.81 ft	11198.52	8959.26	22399.25	19397.4	15837.94	11198.52	6	✓
<b>4 capas</b>										
EP444	4"	13.12 ft	19803.92	15842.26	39610.05	34301	28007.24	19803.92	6	On Request
EP445	4"	16.40 ft	19803.92	15842.26	39610.05	34301	28007.24	19803.92	1	✓
EP446	4"	19.68 ft	19803.92	15842.26	39610.05	34301	28007.24	19803.92	1	On Request
EP448	4"	26.24 ft	19803.92	15842.26	39610.05	34301	28007.24	19803.92	1	On Request
EP4410	4"	32.81 ft	19803.92	15842.26	39610.05	34301	28007.24	19803.92	1	✓

### FLAT WEB SLINGS



### RATED CAPACITY



### CAUTIONS

- Inspect the product before use.
- Protect the band and avoid sharp edges.
- Do not use for lifting.
- Avoid sun exposure.
- Do not use over 93°C temperature.
- Stretched store to avoid deformations.
- Only use the lifting methods recommended.
- It's prohibited tying knots or ties with them.

SLING WIDTH	LAYERS	VERTICAL	LINKED	90°	60°	45°	30°
1 in	2	3,201 lb	2,559 lb	6,402 lb	5,542 lb	4,526 lb	3,201 lb
2 in	2	6,402 lb	5,121 lb	12,804 lb	11,087 lb	9,054 lb	6,402 lb
3 in	2	6,402 lb	5,121 lb	12,804 lb	11,087 lb	9,054 lb	6,402 lb
4 in	2	8,803 lb	7,041 lb	17,603 lb	15,247 lb	12,447 lb	8,803 lb
3 in	2	8,803 lb	7,041 lb	17,603 lb	15,247 lb	12,447 lb	8,803 lb
4 in	2	11,208 lb	8,961 lb	22,405 lb	19,402 lb	15,842 lb	11,201 lb
4 in	2	11,201 lb	8,961 lb	22,405 lb	19,402 lb	15,842 lb	11,201 lb
4 in	4	19,804 lb	15,842 lb	39,610 lb	34,301 lb	28,007 lb	19,804 lb

## RATCHET TIE DOWN STRAP

### RATCHET TIE



**8**  
PIECES

Content	
Ratchet tie downs 1" x 15'	2
Stretch cord 5/16" x 1'	2
Stretch cord 5/16" x 1,5'	2
Stretch cord 5/16" x 2'	2

- Working load limit: 378 kg, ensuring reliable performance for securing loads.
- Made from 100% high-strength polyester for durability and long service life.

ITEM	PIECES	AVAILABLE
151144	8	On Request



### TIE DOWN SET WITH RATCHET AND BUCKLE



**4**  
PIECES

Content	
Ratchet tie downs 1" x 15'	2
Buckle tie downs 1" x 5,9'	2

- Working load limit: 227 kg for ratchet type and 181 kg for buckle type.
- Manufactured from 100% high-strength polyester for durability and reliable performance.

ITEM	PIECES	AVAILABLE
151151	4	On Request



### TIE DOWN SET WITH RATCHET



**4**  
PIECES

**2**  
PIECES

**2**  
PIECES

- Made of 100% high-strength polyester for durability and reliability.
- Working load limit of 227 kg ensures secure fastening of loads.
- Features a quick-release strap mechanism for fast and easy operation.
- Perfect for securing automobiles, boats, motorcycles, and tractors.



ITEM	PIECES	DIMENSIONS	AVAILABLE
151150	4	1" x 15'	On Request
151154	2	1" x 15'	On Request
151156	2	1" x 5,9'	On Request



### TIE DOWN SET WITH BUCKLE



**4**  
PIECES

**2**  
PIECES

- Tightens and secures loads quickly and safely.
- Made of 100% high-strength polyester for long-lasting performance.
- Working load limit of 181 kg ensures reliable fastening.
- Quick-release strap mechanism allows fast, easy operation.
- Perfect for securing automobiles, boats, motorcycles, and tractors.



ITEM	PIECES	DIMENSIONS	AVAILABLE
151152	4	1" x 5,9'	On Request
151153	2	1" x 5,9'	On Request



### RATCHET TIE DOWN STRAP



- Manufactured from high-tenacity polyester with UV-resistant coating for extended durability.
- Equipped with strong wire J-hooks for secure fastening.
- Meets WSTDA standard for safety and reliable performance.



ITEM	BELT WIDTH		TOTAL LENGTH		LOAD CAPACITY		AVAILABLE
	IN	MM	M	FT	KG	LB	
SMG7	4"	101.6	9	30'	2,450	5,401	On Request
SMG6	3"	76.2	9	30'	2,724	6,005	On Request
SMG5	2"	50.8	9	30'	1,513	3,336	✓
SMA3	1"	25.4	6	20'	380	838	On Request

### RATCHET TIE DOWNS



- Perfect tie-down solution for trailers and trucks.
- Made of 100% high-strength polyester for superior durability and reliability.

ITEM	BELT WIDTH	TOTAL LENGTH	LOAD CAPACITY		AVAILABLE		
			IN	MM		M	FT
<b>Wire hook</b>							
151134	4"	101.6	9	30'	2,450 5,401	1	On Request
151133	3"	76.2	9	30'	2,724 6,005	1	On Request
151130	2"	50.8	9	30'	1,513 3,336	1	On Request
<b>Flat hook</b>							
151131	2"	50.8	9	30'	1,513 3,336	1	On Request

### 1" RATCHET TIE DOWN



151100

- Designed for securing automobiles, boats, motorcycles, and tractors with confidence.
- Maximum assembly strength of 681 kg with a working load limit of 227 kg.
- Made of 100% high-strength polyester for durability and reliability.

ITEM	DIMENSIONS	AVAILABLE
151100	1" x 5,9'	On Request
151101	1" x 9,8'	On Request
151102	1" x 14,8'	On Request

### BUCKLE FASTENERS



151121

- Perfect for securing automobiles, boats, motorcycles, and tractors.
- Working load limit of 181 kg with a breaking strength of 545 kg for reliable performance.
- Made of 100% high-strength polyester, offering durability and long service life.

ITEM	BELT WIDTH	TOTAL LENGTH	LOAD CAPACITY		AVAILABLE		
			IN	MM		M	FT
151120	1	25	1.8	6	181 400	6	On Request
151121	1	25	3	10	181 400	6	On Request

## WINCH STRAPS

### TECNICAL BAND



**BAMA9**



**BAMP9**

- Built with a 3:1 safety factor for reliable performance.
- Manufactured from 100% high-strength polyester to ensure durability and long service life.



ITEM	BELT WIDTH IN	BELT WIDTH MM	TOTAL LENGTH M	TOTAL LENGTH FT	LOAD CAPACITY KG	LOAD CAPACITY LB	HOOK	☑	AVAILABLE
BAMP8	4"	101.6	8	26'	2,450	5,401	Plano	1	On Request
BAMP9	4"	101.6	9	29'	2,450	5,401	Plano	1	On Request
BAMA9	4"	101.6	9	29'	3,025	6,669	Alambre	1	On Request

### TECNICAL BAND



**151135**



**151140**



**151138**

- Assemblies made with 100% polyester webbing coated in resin, providing superior strength and durability while meeting platform requirements.
- Built with a 3:1 safety factor to ensure reliable and secure performance.



ITEM	BELT WIDTH IN	BELT WIDTH MM	TOTAL LENGTH M	TOTAL LENGTH FT	LOAD CAPACITY KG	LOAD CAPACITY LB	HOOK	☑	AVAILABLE
151135	4"	101	8	26	2500	5511	Plano	1	On Request
151136	4"	101	9	29	2500	5511	Plano	1	On Request
151140	4"	101	9	29	2500	5511	Con seguro	1	On Request
151138	4"	101	9	29	2500	5511	De alambre	1	On Request

## BUNGEE CORDS AND RUBBER STRAPS

### BUNGEE CORD SETS



**24  
PIECES**

Content -151261-

13/64" x 6" (5 x 152.4 mm)	4
13/64" x 10" (5 x 254 mm)	1
13/64" x 12" (5 x 304.8 mm)	3
5/16" x 12" (8 x 304.8 mm)	4
5/16" x 18" (8 x 457.2 mm)	3
5/16" x 24" (8 x 609.6 mm)	3
5/16" x 28" (8 x 711.2 mm)	3
5/16" x 36" (8 x 914.4 mm)	2
5/16" x 50" (8 x 1270 mm)	1

**12  
PIECES**

Content -151260-

13/64" x 10" (5 x 254 mm)	2
5/16" x 12" (8 x 304.8 mm)	2
5/16" x 18" (8 x 457.2 mm)	2
5/16" x 24" (8 x 609.6 mm)	2
5/16" x 30" (8 x 762 mm)	2
5/16" x 36" (8 x 914.4 mm)	2



**151261**

- Equipped with strong steel hooks for secure fastening.
- Manufactured from durable rubber with a protective nylon coating for extended service life.

ITEM	PIECES	☑	AVAILABLE
151261	24	3	✓
151260	12	6	✓

### RUBBER TARP STRAPS



**151253**

- Manufactured from durable rubber with reinforced ends for greater strength.
- Equipped with sturdy steel hooks for secure fastening.
- Convenient 2-piece pack.

ITEM	SIZE	☑	AVAILABLE
151252	21-1/4"	12	✓
151253	31-3/32"	12	✓
151254	40-15/16"	12	✓

## LIFTING TABLE CARTS

### LIFTING TABLE CART



**5 511 LB**  
TOTAL LOAD CAPACITY

**2 SWIVEL  
CASTERS**



Safety valve against overloading.



Hydraulic stroke limitation.



- Perfect for lifting and servicing materials in workshops.
- Safety pins securely lock the table at various heights, preventing accidental lowering.
- Features a quick-approach pedal for faster and more efficient operation.



ITEM	CAPACITY	MINIMUM HEIGHT	MAXIMUM HEIGHT	TABLE LENGTH	TABLE WIDTH	BASE LENGTH	BASE WIDTH	STROKE	☑	AVAILABLE
2484	5,511 lb	11.8"	34.6"	41.7"	21.3"	56.6"	31.3"	22.8"	1	✓

## LIFTING TABLE CARTS

### LIFTING TABLE CART



**661 LB**  
TOTAL LOAD CAPACITY

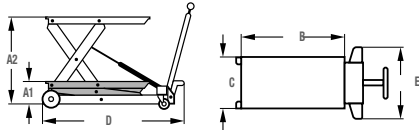

MEL3

- Quick-approach pedal for fast and efficient lifting.
- Double-scissor support design provides extra safety and strength.
- Equipped with wheels featuring brake and guard for secure mobility.
- Reliable hydraulic system for smooth operation.
- Includes safety pins for added protection during use.

ITEM	CAPACITY	A1 MINIMUM HEIGHT	A2 MAXIMUM HEIGHT	B TABLE LENGTH	C TABLE WIDTH	D BASE LENGTH	E BASE WIDTH	HYDRAULIC STROKE	⊞	AVAILABLE
MEL3	300 kg	27 cm	90 cm	82,9 cm	50 cm	88 cm	49 cm	63 cm	1	On Request
MEL10	1,000 kg	41 cm	100 cm	100 cm	51,2 cm	112 cm	61 cm	59 cm	1	On Request

## HAND PALLET TRUCKS

### HAND PALLET TRUCKS



**6 613 LB**  
TOTAL LOAD CAPACITY



TRH3

#### QUICK GUIDE TO USE

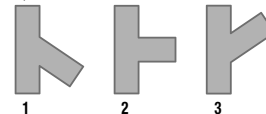

1. To lift load.
2. To move load.
3. To lower load.

#### CAUTIONS

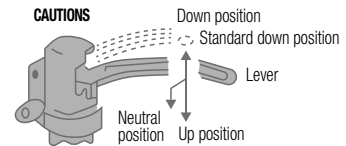

Push the lever up when the lift is idle or not in the lift position, perform several pumping movements to its limit, and hold the handle firmly. When it is lowered the pump will bleed through the release valve.

- Designed for heavy-duty use in warehouses and industrial environments for efficient loading, transport, and unloading of materials.
- Tandem wheel system guarantees smooth, reliable performance even on uneven floors.
- Strong steel handle with ergonomic non-slip plastic grip for comfortable operation.
- Durable all-steel body built to withstand demanding workloads.
- Equipped with a grease fitting for easy bearing maintenance and long service life.

ITEM	CAPACITY	WHEELS & ROLLERS	FORKS WIDTH	FORKS LENGTH	MINIMUM LIFTING HEIGHT	MAXIMUM LIFTING HEIGHT	OVERALL WIDTH	⊞	AVAILABLE
TRH3	5,512 lb	Poliuretano	6-5/16"	45-1/4"	3"	7-1/2"	21-1/4"	1	On Request
TRH25	6,613 lb	Poliuretano	6-9/32"	48"	3"	7-1/2"	21-15/16"	1	On Request



usa.urrea.com

## HAND PALLET TRUCKS

### HAND PALLET TRUCKS



• Model TRHLI2 is not equipped with this system.



• Steering control wheels, 180 x 50 mm, designed for precise maneuverability and smooth handling.



• Tandem roller system, 74 x 70 mm, for greater load stability and smoother movement on uneven surfaces.

#### QUICK GUIDE TO USE

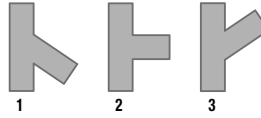

1. To lift load.
2. To move load.
3. To lower load.

#### CAUTIONS

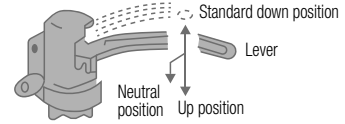

Push the lever up when the lift is idle or not in the lift position, perform several pumping movements to its limit, and hold the handle firmly. When it is lowered the pump will bleed through the release valve.



NEW



TRH5

• Master use

TRHB2

• With scale

TRHP2

TRHP25



TRHN3

TRHP3

TRHB15

• Extra low.

TRHLI2

• Light-duty

- Lightweight lever design for easy and effortless handling.
- Reinforced 3 mm metal body ensures durability and strength under demanding use.



ITEM	TRH5	TRHB2	TRHP3	TRHP25	TRHN3	TRHP2	TRHB15	TRHLI2
USE	MASTER USE	PROFESSIONAL USE	PROFESSIONAL USE	PROFESSIONAL USE	PROFESSIONAL USE	PROFESSIONAL USE	GENERAL USE	GENERAL USE
CAPACITY	5T	2T	2T	2.5T	2.5T	3T	1.5T	2T
WHEELS & ROLLERS	Steel	Polyurethane	Polyurethane	Polyurethane	Nylon	Polyurethane	Poliuretano	Poliuretano
FEATURES	Master use	With scale	-	Polyurethane	-	Professional	Extra baja	Uso ligero
DISTANCE BETWEEN ARMS	365 mm	365 mm	385 mm	385 mm	385 mm	385 mm	220 mm	365 mm
ARM LENGTH	1,220 mm	1,220 mm	1,220 mm	1,220 mm	1,220 mm	1,220 mm	1,150 mm	900 mm
ARM WIDTH	150 mm	150 mm	150 mm	150 mm	150 mm	160 mm	160 mm	160 mm
MINIMUM LIFT	75 mm	75 mm	75 mm	75 mm	75 mm	85 mm	51 mm	75 mm
MAXIMUM LIFT	190 mm	190 mm	190 mm	190 mm	190 mm	200 mm	165 mm	190 mm
☒	1	1	1	1	1	1	1	1
AVAILABLE	On Request	On Request	On Request	On Request	On Request	On Request	On Request	On Request



## HAND PALLET TRUCKS

### HAND PALLET TRUCK SPARE PARTS



**BULK**

ITEM	DESCRIPTION	MATERIAL	FOR ITEM	AVAILABLE
<b>Rollers pair</b>				
ROTB	Par de rodillos	Polyurethane	TRHP2, TRHP25	1 On Request
RONTC	Par de rodillos	Naylon	TRHN3	1 On Request
<b>wheels pair</b>				
RUTB	Par de ruedas	Polyurethane	TRHP2, TRHP25	1 On Request
RUNTB	Par de ruedas	Naylon	TRHN3	1 On Request

ITEM	DESCRIPTION	MATERIAL	FOR ITEM	AVAILABLE
<b>handles for pallet jacks</b>				
MATB	Handles for pallet jacks	Steel	TRHP2, TRHP25, TRHN3	1 On Request

## HOISTS

### ELECTRIC CHAIN HOISTS



- Equipped with a high-torque motor and instant-stop brake system for greater safety and precise load control.



- High-strength grade-80 load chain, calibrated and tested in accordance with EN 818/7 standards.
- Manufactured with special anti-wear and anti-corrosion treatment steel for maximum durability and safety.



ITEM	CAPACITY	ENGINE POWER	HORSEPOWER	VOLTAGE	WEIGHT (kg)	DUTY CYCLE	LOAD CAIN FALL	HOOK OPENING IN	CHAIN LENGHT FT	CHAIN DIAMETER FT	CART TYPE	AVAILABLE
45300	0.5T	370 W	1/2	220 V	24	47% del peso - 10,2 min	1	21	3	5	Hook	✓
45301	1 T	750 W	1	220 V	39	47% del peso - 10,2 min	1	21	3	7	Hook	✓
45302	2 T	1500 W	2	220 V	60	47% del peso - 10,2 min	1	25	3	10	Hook	✓
45303	3 T	1500 W	2	220 V	76	47% del peso - 10,2 min	2	33	3	10	Hook	✓

### ELECTRIC CHAIN HOISTS WITH DOUBLE CHAIN BRAKE SYSTEM



- Dual brake system for enhanced safety and reliability.
- Built with a 3:1 safety factor for secure lifting operations.
- Heavy-duty steel chain ensures strength and durability.
- Equipped with a 360° swivel hook for easy and safe load handling.



ITEM	CAPACITY	ENGINE POWER	HORSEPOWER	VOLTAGE	WEIGHT (kg)	DUTY CYCLE	LOAD CAIN FALL	HOOK OPENING IN	CHAIN LENGHT FT	CHAIN DIAMETER FT	CART TYPE	AVAILABLE
POEL01	0.5 T	370 W	3/4	220 V	35.5	47%- 10.2 min	1	21	3.5	6	Push	✓
POEL03	1 T	0.75 W	1	220 V	8.8 A	2.64 m/min	2	21	7	6	Push	✓
POEL07	2 T	1500 W	1-1/2	220 V	75	47%- 10.2 min	2	25	13	8	Push	✓
POEL09	3 T	1500 W	1-1/2	220 V	77	47%- 10.2 min	2	33	13	8	Push	✓
POEL11	5 T	2500 W	2	220 V	135	47%- 10.2 min	2	40	13	10	Push	✓

## HOISTS

### ELECTRIC HOIST WITH CABLE



NEW

- Easy-to-connect cable for quick setup and operation.
- Swivel crane design prevents cable jamming and ensures smoother lifting.
- Automatic safety stop activates if load capacity is exceeded.
- Convenient control pendant with integrated emergency stop button for maximum operator safety.



ITEM	CAPACITY	ENGINE POWER	HORSEPOWER	VOLTAGE	WEIGHT (kg)	DUTY CYCLE	LOAD CAIN FALL	HOOK OPENING IN	CHAIN LENGT FT	CHAIN DIAMETER IN	CART TYPE	⊞	AVAILABLE
POLEC1	0.4T	950 W	1/2	110V	16	20%-10 min	1	21.13	12	4	Fixed	1	On Request
POLEC2	0.6T	1200 W	1	110V	16.5	20%-10 min	1	21.13	12	4	Fixed	1	On Request
POLEC3	0.8T	1300 W	2	110V	18.5	20%-10 min	1	21.13	12	5	Fixed	1	On Request
POLEC4	1T	1700 W	2	110V	31	20%-10 min	1	21.13	12	6	Fixed	1	On Request

### MANUAL CHAIN HOISTS WITH INSTANT-ACTING CHAIN BRAKE

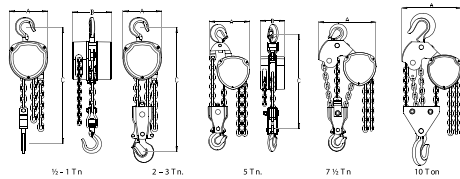

- Fully enclosed construction keeps out dust and moisture, ensuring longer service life.
- Comes with a 3 m long grade 80 calibrated steel load chain for strength and reliability.
- Innovative front-drive system speeds up lowering while reducing operator effort.
- Maximum safety provided by a patented instant-acting brake system.



ITEM	CAPACITY	CHAIN LENGT ft	CHAIN DIAMETER IN	HOOK OPENING IN	LOAD CAIN FALL	A (In)	B (In)	C (In)	⊞	AVAILABLE
46300	0.5T	9.8ft	0.2"	0.8"	1	10.2"	5.1"	9"	1	On Request
46301	1T	9.8ft	0.2"	0.8"	1	12.2"	6.2"	10.2"	1	✓
46302	2T	9.8ft	0.2"	1.1"	1	14.9"	7"	11"	1	On Request
46303	3T	9.8ft	0.3"	1"	2	20.5"	10.2"	11"	1	On Request

### RACK WITH 4 CHAIN HOIST

5 PIECES



CONTENIDO



ITEM	DESCRIPTION	⊞	AVAILABLE
RPOLC	Rack with 4 chain hoist	1	On Request

## HOISTS

### MANUAL CHAIN HOIST



URREA

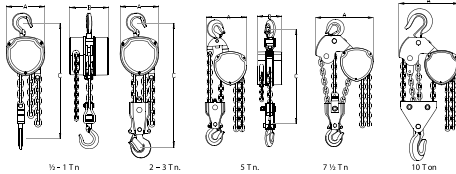

42303



- Maximum safety in operation thanks to a dual brake system.
- Durable hardened steel gearbox ensures long-lasting performance under heavy use.
- Forged steel swivel hooks with safety latch provide secure and versatile load handling.
- High-strength grade 80 black-finished chain for reliable lifting capacity and durability.



ITEM	CAPACITY	CHAIN LENGTH FT	CHAIN DIAMETER IN	HOOK OPENING IN	LOAD CHAIN FALL	A IN	B IN	C IN	TEST CHARGE KG	⊞	AVAILABLE
<b>with 3 meter chain</b>											
42300	1/2t	9.8ft	0.2"	1.6"	1	5.3"	4.6"	12.9"	3/4t	1	✓
42301	1t	9.8ft	0.2"	1.6"	1	5.9"	5.1"	12.9"	1.5t	1	✓
42303	3t	9.8ft	0.3"	2"	2	8.8"	6.8"	22"	4.5t	1	On Request
42305	5t	9.8ft	0.4"	2.7"	2	10.2"	6.8"	28.5"	7.5t	1	✓
42307	7.5t	9.8ft	0.4"	2.7"	3	13.7"	6.8"	31.4"	11.25t	1	On Request
42310	10t	9.8ft	0.4"	2.7"	4	13.7"	6.8"	35"	15t	1	On Request
<b>with 6 meter chain</b>											
42600	1/2t	19.6ft	0.2"	1.6"	1	5.1"	118"	12.9"	3/4t	1	✓
42601	1t	19.6ft	0.2"	1.6"	1	5.9"	5.1"	12.9"	1.5t	1	✓
42602	2t	19.6ft	0.2"	2"	2	5.9"	5.1"	18"	3t	1	On Request
42603	3t	19.6ft	0.3"	2"	2	8.8"	6.8"	22"	4.5t	1	On Request
42605	5t	19.6ft	0.4"	2.7"	2	10.2"	6.8"	28.5"	7.5t	1	On Request

### MANUAL CHAIN HOISTS WITH DOUBLE CHAIN BRAKE SYSTEM



SURTEK



NEW

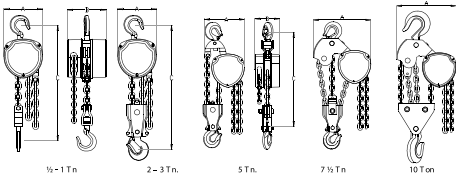

POLAC1A



- Dual brake system enhances safety during operation.
- Heat-treated gearbox ensures durability and reliable performance.
- Forged steel swivel hooks with safety latch reduce chain stress and allow safe load handling.
- Overload protection: hooks are designed to gradually open instead of breaking suddenly.
- Equipped with high-strength grade 80 steel chain for heavy-duty lifting.
- Black-finished steel chain for added protection and environmental resistance.



ITEM	CAPACITY	CHAIN LENGTH (FT)	CHAIN DIAMETER IN	HOOK OPENING IN	LOAD CHAIN FALL	A (in)	B (in)	C (in)	⊞	AVAILABLE	
<b>with 3 meter chain</b>											
POLAC1A	0.5T	3ft	0.2"	0.8"	1	4.4"	4.4"	10"	1	On Request	
POLAC2A	1T	3ft	0.2"	0.9"	1	5.7"	4.9"	12.4"	1	On Request	
POLAC3A	2T	3ft	0.2"	1.2"	2	7.2"	5.5"	14.4"	1	On Request	
POLAC4A	3T	3ft	0.3"	1.4"	2	7.2"	5.5"	19.3"	1	On Request	
POLAC5A	5T	3ft	0.4"	1.8"	2	8.4"	6.4"	24"	1	On Request	
POLAC7A	7.5T	3ft	0.4"	2.1"	3	15.9"	6.4"	29"	1	On Request	
POLAC10A	10T	3ft	0.4"	2.2"	4	15.9"	6.4"	29"	1	On Request	
<b>with 6 meter chain</b>											
POLAC1A-6	0.5T	6ft	0.2"	0.8"	1	4.9"	4.4"	10"	1	On Request	
POLAC2A-6	1T	6ft	0.2"	0.9"	1	5.7"	4.4"	12"	1	On Request	
POLAC3A-6	2T	6ft	0.2"	1.2"	2	7.2"	5.5"	14.4"	1	On Request	
POLAC4A-6	3T	6ft	0.3"	1.4"	2	7.2"	5.5"	19.1"	1	On Request	
POLAC5A-6	5T	6ft	0.4"	1.8"	2	8.4"	6.4"	24"	1	On Request	

## HOISTS

### MANUAL CHAIN HOISTS



NEW

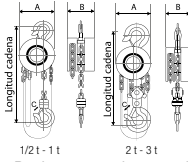

POLAC2L



- Brake protection mechanism reduces wear and extends service life.
- Compact design for easier handling and efficient use in limited spaces.

ITEM	CAPACITY	CHAIN LENGTH (FT)	CHAIN DIAMETER (In)	HOOK OPENING (In)	LOAD CAIN FALL	A (In)	B (In)	C (In)	⊞	AVAILABLE
POLAC1L	0.5T	9.8ft	0.2"	0.9"	1	5.5"	4.9"	0.7"	1	On Request
POLAC2L	1T	9.8ft	0.2"	0.9"	1	5.5"	4.9"	0.8"	1	On Request
POLAC3L	2T	9.8ft	0.2"	1.1"	2	5.5"	4.9"	1.1"	1	On Request
POLAC4L	3T	9.8ft	0.3"	1.4"	2	7"	5.5"	1.3"	1	On Request

### CHAIN LEVER HOIST

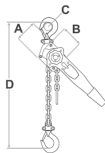

- Compact and lightweight design, ideal for use in confined or hard-to-reach spaces.
- Quick chain adjustment system for faster and easier operation.
- Dual brake system ensures maximum safety during lifting.
- Exclusive anti-unlocking mechanism provides additional security and reliability.

ITEM	CAPACITY	CHAIN LENGTH (FT)	CHAIN DIAMETER (In)	HOOK OPENING (In)	LOAD CAIN FALL	A (In)	B (In)	C (In)	D (In)	⊞	AVAILABLE
47015	0.75T	5.6ft	0.2"	1"	1	4.9"	5.6"	1.3"	9.6"	1	✓
47115	1.5T	5.7ft	0.3"	1.2"	1	4.9"	6.2"	1.6"	10.4"	1	On Request
47315	3.2T	6ft	0.4"	1.5"	1	6.2"	7.4"	1.9"	16.3"	1	On Request

### CHAIN LEVER HOIST

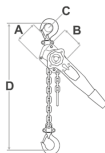

POPA01



- Lever hoist equipped with a 360° swivel hook for versatile load handling.
- Ergonomic rubber handle provides a comfortable, secure grip during operation.

ITEM	CAPACITY	CHAIN LENGTH (FT)	CHAIN DIAMETER (In)	HOOK OPENING (In)	LOAD CAIN FALL	A (In)	B (In)	C (In)	D (In)	⊞	AVAILABLE
POPA01	0.75 t	4.9ft	0.2"	1.4"	1	5.8"	3.8"	1.4"	12.7"	1	On Request
POPA02	1.5t	4.9ft	0.3"	1.7"	1	6.7"	3.8"	1.7"	14.9"	1	On Request
POPA03	3t	4.9ft	0.3"	1.9"	1	7.8"	4.5"	1.9"	18.8"	1	On Request
POPA04	6t	9.8ft	0.3"	2.5"	2	7.8"	4.5"	2.5"	24.4"	1	On Request

## HOISTS

### CHAIN LEVER HOIST

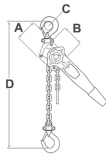

POLPAL1



NEW

- Double pawl brake system for greater safety and reliability.
- Lever design reduces effort, making lifting loads easier and more efficient.
- Heavy-duty forged hooks with full 360° rotation for versatile load handling.
- Ergonomic handle with non-slip grip ensures safe and comfortable operation.

ITEM	CAPACITY	CHAIN LENGTH (FT)	CHAIN DIAMETER (In)	HOOK OPENING (In)	LOAD CAIN FALL	A (In)	B (In)	C (In)	D (In)	⊞	AVAILABLE
POLPAL1	0.75t	1.5	0.23"	5.5"	1	3.7"	5.3"	1.4"	12.6"	1	On Request
POLPAL2	1.5t	1.5	0.31"	9.4"	1	4.1"	6.1"	1.7"	14.9"	1	On Request
POLPAL3	3t	1.5	0.39"	12.5"	1	5.1"	7.8"	1.9"	18.8"	1	On Request
POLPAL6	6t	1.5	0.39"	13.3"	2	5.1"	7.8"	2.4"	23.6"	1	On Request



## TROLLEY

### LOAD TROLLEY



ADAPTS TO IPS & IPR BEAMS



- Each wheel includes a sealed bearing for smooth and reliable operation.
- Equipped with a recessed ring for secure hoist attachment.
- Adjustable main axle with washers to fit a wide range of beams.
- Welded bearing housing provides superior stability and durability.
- Central pin with eye design allows compatibility with any type of hoist—especially Urrea hoists.



3305



ITEM	CAPACITY	WEIGHT (lb)	BEAM HOIST	HOIST WIDTH INCHES	HOIST WIDTH FT	RANGE OF TURN	⊞	AVAILABLE
3305	0.5t	17.6 lb	3" - 15"	2.5" - 5.13"	0.20 ft - 0.44ft	39"	1	On Request
3310	1t	26.4 lb	5" - 24"	3" - 8"	0.24 ft - 0.66 ft	49"	1	On Request
3320	2t	57.3 lb	5" - 24"	3.9" - 8"	0.28 ft - 0.66 ft	59"	1	✓
3330	3t	79.3 lb	6" - 24"	3.7" - 8"	0.30 ft - 0.66 ft	66"	1	On Request
3350	5t	143 lb	6" - 24"	4.250" - 8.7"	0.35 ft - 0.72 ft	68"	1	On Request

### LOAD TROLLEY



ADAPTS TO IPS BEAMS



NEW

- Central pin with eye allows easy adaptation to any hoist.
- Cast steel wheels with bearing mounts ensure smooth, effortless travel along beams.



TR005



ITEM	CAPACITY	WEIGHT (lb)	BEAM HOIST	HOIST WIDTH INCHES	HOIST WIDTH FT	RANGE OF TURN	⊞	AVAILABLE
TR005	0.5t	9 lb	2.52" - 4.53"	2.64" - 4.92"	0.2 ft - 0.4 ft	59.1"	1	On Request
TR01	1t	14.3 lb	2.95" - 5.12"	3.07" - 5.2"	0.25 ft - 0.43 ft	70.9"	1	On Request
TR02	2t	20 lb	3.82" - 6.3"	4.13" - 6.3"	0.34 ft - 0.52 ft	78.7"	1	On Request
TR03	3t	32.9 lb	4.33" - 6.69"	3.74" - 6.5"	0.31 ft - 0.54 ft	98.4"	1	On Request
TR05	5t	58.9 lb	4.33" - 7.36"	4.53" - 7.32"	0.37 ft - 0.61 ft	138"	1	On Request

## HAND PULLERS

### HAND PULLERS



151200

- Heavy-duty all-steel construction for durability and strength.
- Equipped with forged steel hooks for secure load handling.
- Triple-joint teeth with double gear system ensure reliable performance.
- Standard series, ideal for moving heavy equipment and tensioning cables.
- Safety precautions: always respect the maximum working load, inspect before use, operate in a straight line, and never use pipes as levers or loop cables around objects.



ITEM	PULLING CAPACITY	LIFTING CAPACITY	WIRE ROPE DIAMETER	WIRE ROPE LENGTH	⊞	AVAILABLE
151200	1t	0.5t	5/32"	3,8'	1	On Request
151201	2t	1t	3/16"	4,6'	1	On Request
151202	3t	1t	3/16"	6'	1	On Request
151203	4t	2t	1/4"	6'	1	On Request

CARGO HANDLING

## CASTERS

### FURNITURE CASTER WITH LATCH



- Durable nylon wheel designed for strength and reliability.
- Chemical-resistant: withstands acetone, alcohol, sodium, and mild solvents for longer service life.

ITEM	RY5P	RY5PB	RY4R	RY5R	RY4RB	RY5RB
	LATCH WITH RING STEM		THREADED LATCH WITHOUT BRAKE		THREADED LATCH WITH BRAKE	
DIAMETER	2"/50 mm	2"/50 mm	1-5/8"/40 mm	2"/50 mm	1-5/8"/40 mm	2"/50 mm
LOAD CAPACITY	44 lb	66 lb	44 lb	55 lb	44 lb	55 lb
CASTER WIDTH	1-27/32"	2-1/8"	1-1/2"	1-13/16"	1-1/2"	1-27/32"
TOTAL HEIGHT	2-15/32"	2-9/16"	2"	2-15/32"	2"	2-15/32"
STAKE HEIGHT		11 mm		10 mm		10 mm
STAKE DIAMETER		22 mm		19 mm		19 mm
⊕	1	1	1	1	1	1
AVAILABLE	On Request	On Request	On Request	On Request	On Request	On Request

### FURNITURE CASTER WITH PLATE



- Durable nylon wheel designed for strength and reliability.
- Chemical-resistant: withstands acetone, alcohol, sodium, and mild solvents for longer service life.

ITEM	RY4G	RY5G	RY4B	RY5B
	WITHOUT BRAKE		WITH BRAKE	
DIAMETER	1-5/8"/40 mm	2"/50 mm	1-5/8"/40 mm	2"/50 mm
LOAD CAPACITY	55 lb	66 lb	55 lb	66 lb
CASTER WIDTH	1-1/2"	1-27/32"	1-1/2"	1-27/32"
TOTAL HEIGHT	2-1/8"	2-1/2"	2-1/8"	2-1/2"
PLATE DIMENSION		1-1/2" x 1-1/2"		1-1/2" x 1-1/2"
HOLE DISTANCE		15/16" x 15/16"		15/16" x 15/16"
HOLE DIMENSION		7/32"		7/32"
⊕	1	1	1	1
AVAILABLE	On Request	On Request	On Request	On Request

### BALL CASTER WITH LATCH



- Rubber wheel with strong chrome-finished bracket.
- Provides smooth, quiet mobility with durability for everyday use.
- Resistant to acetone, alcohol, sodium, and mild solvents, extending service life.

ITEM	RE4P	RE5P	RE4R	RE5R	RE4M	RE5M
	LATCH		THREADED LATCH		WOOD LATCH	
DIAMETER	1-5/8"/40 mm	2"/50 mm	1-5/8"/40 mm	2"/50 mm	1-5/8"/40 mm	2"/50 mm
LOAD CAPACITY	44 lb	55 lb	44 lb	55 lb	44 lb	55 lb
CASTER WIDTH	1-9/32"	1-21/32"	1-9/32"	1-21/32"	1-9/32"	1-21/32"
TOTAL HEIGHT	2-1/16"	2-13/32"	2-1/4"	2-9/16"	2-5/32"	2-15/32"
STAKE HEIGHT		11 mm		10 mm		8 mm
STAKE DIAMETER		35 mm		35 mm		38 mm
⊕	1	1	1	1	1	1
AVAILABLE	On Request	On Request	On Request	On Request	On Request	On Request

### BALL CASTER WITH PLATE



- Rubber wheel with strong chrome-finished bracket.
- Provides smooth, quiet mobility with durability for everyday use.
- Resistant to acetone, alcohol, sodium, and mild solvents, extending service life.

ITEM	RE4G	RE5G
DIAMETER	1-5/8"/40 mm	2"/50 mm
LOAD CAPACITY	44 lb	55 lb
CASTER WIDTH	1-1/4"	1-21/32"
TOTAL HEIGHT	2-1/8"	2-7/16"
PLATE DIMENSION	1-1/2" x 1-1/2"	1-1/2" x 1-1/2"
HOLE DISTANCE	1" x 1"	1" x 1"
HOLE DIMENSION	7/32"	7/32"
⊕	1	1
AVAILABLE	On Request	On Request

**CASTERS**

**RUBBER CASTERS**



- Steel-rim wheel with roller bearings for smooth and reliable performance.
- Zinc-finished bracket for durability and corrosion resistance.
- Ideal for mobile chairs, furniture, and general-purpose applications.
- Resistant to acetone, alcohol, sodium, and mild solvents, ensuring longer service life.



RH5F

RH15F

RH5G

RH5B

RH15G



ITEM	RH5F	RH6F	RH7F	RH10F	RH15F	RH5G	RH6G	RH7G	RH10G	RH5B	RH6B	RH7B	RH15G
	FIXED				FIXED WITH IRON RIM	SWIVEL WITHOUT BRAKE				SWIVEL WITH BRAKE			SWIVEL WITH IRON RIM
DIAMETER	2"/50 mm	2-1/2"/63 mm	3"/75 mm	4"/100 mm	6"/150 mm	2"/50 mm	2-1/2"/63 mm	3"/75 mm	4"/100 mm	2"/50 mm	2-1/2"/63 mm	3"/75 mm	6"/150 mm
LOAD CAPACITY	88 lb	132 lb	154 lb	176 lb	441 lb	88 lb	132 lb	154 lb	176 lb	88 lb	132 lb	154 lb	441 lb
CASTER WIDTH	29/32"	1-3/32"	1-1/4"	1-1/4"	2"	29/32"	1-1/16"	1-1/4"	1-1/4"	29/32"	1-1/16"	1-1/4"	2"
TOTAL HEIGHT	2-1/2"	3-1/8"	3-19/32"	4-31/32"	7-15/32"	2-1/2"	3-5/16"	3-11/16"	5"	2-1/2"	3-5/16"	3-11/16"	7-15/32"
PLATE DIMENSION	2-9/32" x 1-17/32"	3-29/32" x 2"	4-3/32" x 2-5/16"	5-1/16" x 2-23/32"	4-1/2" x 3-15/16"	2-5/8" x 3-15/16"	3-3/4" x 2-3/4"	4-1/8" x 3-1/8"	4" x 3-1/6"	2-5/8" x 1-7/8"	3-3/4" x 2-3/4"	4-1/8" x 3-1/8"	4-1/2" x 3-15/16"
HOLE DISTANCE	2-3/32" x 29/32"	3-3/16" x 1"	3-1/4" x 1-13/32"	4-1/8" x 1-1/2"	3-11/32" x 2-27/32"	2-1/8" x 15/16"	3" x 1-3/4"	3-1/4" x 2-3/8"	2-5/16" x 1-15/16"	2-1/8" x 15/16"	3" x 1-3/4"	3" x 1-3/4"	3-11/32" x 2-27/32"
HOLE DIMENSION	1/4"	5/16"	11/32"	13/32"	7/16"	1/4"	11/32"	11/32"	13/32"	1/4"	11/32"	11/32"	7/16"
☐	1	1	1	1	1	1	1	1	1	1	1	1	1
AVAILABLE	On Request	On Request	On Request	On Request	On Request	On Request	On Request	On Request	On Request	On Request	On Request	On Request	On Request

**BLUE ELASTIC RUBBER CASTER**



- Plastic-rim wheel with smooth ball bearing for reliable mobility.
- Durable plate-type bracket ensures secure mounting.
- Ideal for material handling vehicles, mobile carts, and heavy-duty furniture requiring strong load support.



RG010F

RG010G

RG07B



ITEM	RG07F	RG010F	RG012F	RG07G	RG010G	RG012G	RG07B	RG010B	RG012B
	FIXED			SWIVEL WITHOUT BRAKE			SWIVEL WITH BRAKE		
DIAMETER	3"/75 mm	4"/100 mm	5"/125 mm	3"/75 mm	4"/100 mm	5"/125 mm	3"/75 mm	4"/100 mm	5"/125 mm
LOAD CAPACITY	88 lb	132 lb	200 lb	88 lb	132 lb	200 lb	88 lb	132 lb	200 lb
CASTER WIDTH	1-1/16"	1-9/32"	1-3/8"	1-1/16"	1-9/32"	1-3/8"	1-1/16"	1-9/32"	1-3/8"
TOTAL HEIGHT	3-13/16"	5-1/8"	6-3/32"	3-13/16"	5-1/8"	6-3/32"	3-13/16"	5-1/8"	6-3/32"
PLATE DIMENSION	3-5/16" X 2-27/32"	4" x 3-5/16"	4" x 3-5/16"	3-5/16" X 2-27/32"	4" x 3-5/16"	4" x 3-5/16"	3-5/16" X 2-27/32"	4" x 3-5/16"	4" x 3-5/16"
HOLE DISTANCE	2-7/16" x 1-31/32"	3-1/8" x 2-3/8"	3-1/8" x 2-3/8"	2-7/16" x 1-31/32"	3-1/8" x 2-3/8"	3-1/8" x 2-3/8"	2-7/16" x 1-31/32"	3-1/8" x 2-3/8"	3-1/8" x 2-3/8"
HOLE DIMENSION	11/32" x 7/16"	11/32" x 9/16"	11/32" x 9/16"	11/32" x 7/16"	11/32" x 9/16"	11/32" x 9/16"	11/32" x 7/16"	11/32" x 9/16"	11/32" x 9/16"
☐	1	1	1	1	1	1	1	1	1
AVAILABLE	On Request	On Request	On Request	On Request	On Request	On Request	On Request	On Request	On Request

**BLACK SWIVEL PVC CASTER WITH THREADED STEM**



- Plastic-rim wheel with double ball bearing for smoother, more durable performance.
- Designed for material handling vehicles, mobile carts, and heavy-duty furniture.
- Provides excellent load support and reliable mobility under heavy use.



RVNE5

RVNE5B



ITEM	RVNE5	RVNE6	RVNE7	RVNE5B	RVNE6B	RVNE7B
	SWIVEL WITHOUT BRAKE			SWIVEL WITH BRAKE		
DIAMETER	2"/50 mm	2-1/2"/63 mm	3"/75 mm	2"/50 mm	2-1/2"/63 mm	3"/75 mm
LOAD CAPACITY	88 lb	132 lb	175 lb	88 lb	132 lb	175 lb
CASTER WIDTH	29/32"	1-1/4"	1-1/4"	29/32"	1-1/4"	1-1/4"
TOTAL HEIGHT	2-27/32"	3-5/8"	4-1/16"	2-5/32"	3-5/8"	4-1/16"
STAKE HEIGHT	9.5 mm	12.7 mm	12.7 mm	9.5 mm	12.7 mm	12.7 mm
STAKE DIAMETER		25 mm			25 mm	
☐	1	1	1	1	1	1
AVAILABLE	On Request	On Request	On Request	On Request	On Request	On Request

## CASTERS

### BLACK PVC CASTER WITH PLATE



- Plastic-rim wheel with double ball bearing for smoother, more durable performance.
- Designed for material handling vehicles, mobile carts, and heavy-duty furniture.
- Provides excellent load support and reliable mobility under heavy use.



RVN5F

RVN5G

RVN5B

ITEM	RVN5F	RVN6F	RVN7F	RVN5G	RVN6G	RVN7G	RVN5B	RVN6B	RVN7B
	FIXED			SWIVEL WITHOUT BRAKE			SWIVEL WITH BRAKE		
DIAMETER	2"/50 mm	2-1/2"/64 mm	3"/76 mm	2"/50 mm	2-1/2"/64 mm	3"/76 mm	2"/50 mm	2-1/2"/64 mm	3"/76 mm
LOAD CAPACITY	88 lb	132 lb	175 lb	88 lb	132 lb	175 lb	88 lb	132 lb	175 lb
CASTER WIDTH	29/32"	1-1/4"	1-1/4"	29/32"	1-1/4"	1-1/4"	29/32"	1-1/4"	1-1/4"
TOTAL HEIGHT	2-29/32"	3-11/16"	4-7/32"	2-29/32"	3-11/16"	4-7/32"	2-29/32"	3-11/16"	4-1/6"
PLATE DIMENSION	2-3/4" x 2-3/32"	3-3/4" x 2-9/16"	3-3/4" x 2-9/16"	2-3/4" x 2-3/32"	3-3/4" x 2-9/16"	3-3/4" x 2-9/16"	2-3/4" x 2-3/32"	3-3/4" x 2-9/16"	3-3/4" x 2-9/16"
HOLE DISTANCE	2-1/32" x 1-11/32"	2-31/32" x 1-3/4"	2-31/32" x 1-3/4"	2-1/32" x 1-11/32"	2-31/32" x 1-3/4"	2-31/32" x 1-3/4"	2-1/32" x 1-11/32"	2-31/32" x 1-3/4"	2-31/32" x 1-3/4"
HOLE DIMENSION		11/32" x 7/16"			11/32" x 7/16"			11/32" x 7/16"	
⊞	1	1	1	1	1	1	1	1	1
AVAILABLE	On Request	On Request	On Request	On Request	On Request	On Request	On Request	On Request	On Request

### ORANGE PVC CASTERS



- Heavy-duty wheel with PVC tread and polyurethane rim for strength and durability.
- Equipped with double ball bearings for smooth and reliable movement.
- Strong plate-type bracket ensures secure mounting.
- Ideal for material handling vehicles, mobile carts, and heavy furniture requiring high load capacity.



RV5F

RV5G

RV5B

ITEM	RV5F	RV6F	RV7F	RV10F	RV5G	RV6G	RV7G	RV10G	RV5B	RV6B	RV7B	RV10B
	FIXED				SWIVEL WITHOUT BRAKE				SWIVEL WITH BRAKE			
DIAMETER	2"/50 mm	2-1/2"/64 mm	3"/76 mm	4"/100 mm	2"/50 mm	2-1/2"/64 mm	3"/76 mm	4"/100 mm	2"/50 mm	2-1/2"/64 mm	3"/76 mm	4"/100 mm
LOAD CAPACITY	132 lb	154 lb	176 lb	198 lb	132 lb	154 lb	176 lb	198 lb	132 lb	154 lb	176 lb	198 lb
CASTER WIDTH	1"	1-7/32"	1-7/32"	1-7/32"	1"	1-7/32"	1-7/32"	1-7/32"	1"	1-7/32"	1-7/32"	1-7/32"
TOTAL HEIGHT	2-29/32"	3-11/16"	4-7/32"	5-1/8"	2-29/32"	3-11/16"	4-7/32"	5-1/8"	2-29/32"	3-11/16"	4-7/32"	5-1/8"
PLATE DIMENSION	2-27/32" x 2-1/32"	3-5/8" x 2-7/16"	3-5/8" x 2-7/16"	3-5/8" x 2-7/16"	2-27/32" x 2-1/32"	3-5/8" x 2-7/16"	3-5/8" x 2-7/16"	3-5/8" x 2-7/16"	2-27/32" x 2-1/32"	3-5/8" x 2-7/16"	3-5/8" x 2-7/16"	3-5/8" x 2-7/16"
HOLE DISTANCE	2-7/32" x 1-3/8"	3" x 1-27/32"	3" x 1-27/32"	3" x 1-27/32"	3" x 1-27/32"	3" x 1-27/32"	3" x 1-27/32"	3" x 1-27/32"	3" x 1-27/32"	3" x 1-27/32"	3" x 1-27/32"	3" x 1-27/32"
HOLE DIMENSION	5/16" x 7/16"				5/16" x 7/16"				5/16" x 7/16"			
⊞	1	1	1	1	1	1	1	1	1	1	1	1
AVAILABLE	On Request	On Request	On Request	On Request	On Request	On Request	On Request	On Request	On Request	On Request	On Request	On Request

### WHITE POLYPROPYLENE CASTER



- Heavy-duty polypropylene wheel with plastic rim for demanding applications.
- Equipped with double bearings for smoother, more reliable performance.
- Durable plate-type bracket ensures secure and stable mounting.
- Ideal for material handling vehicles, mobile carts, and heavy furniture requiring strong load capacity.



RN10F

RN10G

RN10B

ITEM	RN10F	RN10G	RN10B
	FIXED	SWIVEL WITHOUT BRAKE	SWIVEL WITH BRAKE
DIAMETER	4"/100 mm	4"/100 mm	4"/100 mm
LOAD CAPACITY	441 lb	441 lb	441 lb
CASTER WIDTH	1-11/16"	1-11/16"	1-11/16"
TOTAL HEIGHT	5-19/32"	5-19/32"	5-19/32"
PLATE DIMENSION	4-1/2" x 3-15/16"	4-1/2" x 3-15/16"	4-1/2" x 3-15/16"
HOLE DISTANCE	3-11/32" x 2-27/32"	3-11/32" x 2-27/32"	3-11/32" x 2-27/32"
HOLE DIMENSION	7/16" x 3/4"	7/16" x 3/4"	7/16" x 3/4"
⊞	1	1	1
AVAILABLE	On Request	On Request	On Request



## CASTERS

### WHITE POLYURETHANE CASTERS



RN5F

RN5G

RN5B



- Strong plate-type bracket for secure mounting and stability.
- Designed for material handling vehicles, mobile carts, and heavy-duty furniture requiring reliable load support.

ITEM	RN5F	RN6F	RN7F	RN5G	RN6G	RN7G	RN5B	RN6B	RN7B	
		FIXED			SWIVEL WITHOUT BRAKE			SWIVEL WITH BRAKE		
DIAMETER	2"/50 mm	2-1/2"/64 mm	3"/76 mm	2"/50 mm	2-1/2"/64 mm	3"/76 mm	2"/50 mm	2-1/2"/64 mm	3"/76 mm	
LOAD CAPACITY	110 lb	132 lb	176 lb	110 lb	132 lb	176 lb	110 lb	132 lb	176 lb	
CASTER WIDTH	29/32"	1"	1-7/32"	29/32"	1"	1-7/32"	29/32"	1"	1-7/32"	
TOTAL HEIGHT	2-3/8"	3-5/16"	3-13/16"	2-3/8"	3-5/16"	3-13/16"	2-3/8"	3-5/16"	3-13/16"	
PLATE DIMENSION	2-9/32" x 1-17/32"	3-15/16" x 2-1/32"	4-3/32" x 2-5/16"	2-5/8" x 1-7/8"	3-25/32" x 2-5/8"	4-1/8" x 3-1/32"	2-5/8" x 1-7/8"	3-25/32" x 2-5/8"	4-1/8" x 3-1/32"	
HOLE DISTANCE	53 x 23 mm	81 x 25 mm	83 x 36 mm	54 x 24 mm	76 x 41 mm	85 x 58 mm	54 x 24 mm	76 x 41 mm	85 x 58 mm	
HOLE DIMENSION	6.3 mm	8 mm	8.5 mm	6.3 mm	8 mm	8.5 mm	6.3 mm	8 mm	8.5 mm	
☑	1	1	1	1	1	1	1	1	1	
AVAILABLE	On Request	On Request	On Request	On Request	On Request	On Request	On Request	On Request	On Request	

### GRAY TPR CASTER WITH STAINLESS STEEL HARDWARE



RT110F

RT110G

RT110B



- Durable plate-type bracket for secure mounting and stability.
- Smooth ball bearing system ensures easy movement and long service life.
- Plastic rim construction provides strength while reducing weight.
- Ideal for material handling vehicles, mobile carts, and heavy furniture requiring strong load capacity.

ITEM	RT110F	RT110G	RT110B
	FIXED	SWIVEL WITHOUT BRAKE	SWIVEL WITH BRAKE
DIAMETER	4"/100 mm	4"/100 mm	4"/100 mm
LOAD CAPACITY	243 lb	243 lb	243 lb
CASTER WIDTH	1-1/4"	1-1/4"	1-1/4"
TOTAL HEIGHT	5-3/8"	5-3/8"	5-3/8"
PLATE DIMENSION	3-3/4" x 2-3/4"	3-3/4" x 2-3/4"	3-3/4" x 2-3/4"
HOLE DISTANCE	2-7/8" x 1-7/8"	2-7/8" x 1-7/8"	2-7/8" x 1-7/8"
HOLE DIMENSION	11/32" x 1/2"	11/32" x 1/2"	11/32" x 1/2"
☑	1	1	1
AVAILABLE	On Request	On Request	On Request

### GRAY TPR CASTER



RTG15F

RTG15G

RTG15B



- Strong plate-type bracket for secure installation and stability.
- Equipped with roller bearing for smooth movement and reliable load support.
- Plastic rim construction provides strength with lightweight performance.
- Perfect for material handling vehicles, mobile carts, and heavy-duty furniture.

ITEM	RTG15F	RTG20F	RTG15G	RTG20G	RTG15B	RTG20B
	FIXED		SWIVEL WITHOUT BRAKE		SWIVEL WITH BRAKE	
DIAMETER	6"/150 mm	8"/200 mm	6"/150 mm	8"/200 mm	6"/150 mm	8"/200 mm
LOAD CAPACITY	441 lb	485 lb	441 lb	485 lb	441 lb	485 lb
CASTER WIDTH	1-31/32"	1-31/32"	1-31/32"	1-31/32"	1-31/32"	1-31/32"
TOTAL HEIGHT	7-1/2"	9-7/16"	7-1/2"	9-7/16"	7-1/2"	9-7/16"
PLATE DIMENSION	4-1/2" x 3-15/16"		4-1/2" x 3-15/16"		4-1/2" x 3-15/16"	
HOLE DISTANCE	3-11/32" x 2-27/32"		3-11/32" x 2-27/32"		3-11/32" x 2-27/32"	
HOLE DIMENSION	7/16" x 3/4"		7/16" x 3/4"		7/16" x 3/4"	
☑	1	1	1	1	1	1
AVAILABLE	On Request	On Request	On Request	On Request	On Request	On Request

## CASTERS

### BROWN POLYURETHANE CASTER



- Durable plate-type bracket ensures secure mounting and stability.
- Roller bearing system provides smooth movement and dependable load support.
- Plastic rim construction delivers strength while keeping the wheel lightweight.
- Ideal for material handling vehicles, mobile carts, and heavy furniture requiring high load capacity.



RPU12F



RPU12G



RPU12B



ITEM	RPU10F	RPU12F	RPU16F	RPU18F	RPU10G	RPU12G	RPU16G	RPU18G	RPU10B	RPU12B	RPU16B	RPU18B
	FIXED				SWIVEL WITHOUT BRAKE				SWIVEL WITH BRAKE			
DIAMETER	4"/100 mm	5"/125 mm	6"/150 mm	8"/200 mm	4"/100 mm	5"/125 mm	6"/150 mm	8"/200 mm	4"/100 mm	5"/125 mm	6"/150 mm	8"/200 mm
LOAD CAPACITY	485 lb	331 lb	441 lb	485 lb	485 lb	331 lb	441 lb	485 lb	441 lb	331 lb	441 lb	485 lb
CASTER WIDTH	1-31/32"	1-31/32"	1-31/32"	1-31/32"	1-31/32"	1-31/32"	1-31/32"	1-31/32"	1-31/32"	1-31/32"	1-31/32"	1-31/32"
TOTAL HEIGHT	5-19/32"	6-15/32"	7-1/2"	9-7/16"	5-19/32"	6-15/32"	7-1/2"	9-7/16"	5-19/32"	6-15/32"	7-1/2"	9-7/16"
PLATE DIMENSION	4-1/2" x 3-15/16"				4-1/2" x 3-15/16"				4-1/2" x 3-15/16"			
HOLE DISTANCE	3-11/32" x 2-27/32"				3-11/32" x 2-27/32"				3-11/32" x 2-27/32"			
HOLE DIMENSION	7/16" x 3/4"				7/16" x 3/4"				7/16" x 3/4"			
Ø	1	1	1	1	1	1	1	1	1	1	1	1
AVAILABLE	On Request	On Request	On Request	On Request	On Request	On Request	On Request	On Request	On Request	On Request	On Request	On Request

### PHENOLIC CASTER



- Strong plate-type bracket for stable and secure mounting.
- Roller bearing system ensures smooth operation under heavy loads.
- Plastic rim construction combines strength with reduced weight.
- Perfect for material handling vehicles, mobile carts, and heavy-duty furniture requiring reliable support.



RFE15F



RFE10G



RFE15B



ITEM	RFE10F	RFE15F	RFE20F	RFE10G	RFE15G	RFE20G	RFE10B	RFE15B	RFE20B
	FIXED			SWIVEL WITHOUT BRAKE			SWIVEL WITH BRAKE		
DIAMETER	4"/100 mm	6"/150 mm	8"/200 mm	4"/100 mm	6"/150 mm	8"/200 mm	4"/100 mm	6"/150 mm	8"/200 mm
LOAD CAPACITY	441 lb	617 lb	728 lb	441 lb	617 lb	728 lb	441 lb	617 lb	728 lb
CASTER WIDTH	1-31/32"	1-31/32"	1-31/32"	1-31/32"	1-31/32"	1-31/32"	1-31/32"	1-31/32"	1-31/32"
TOTAL HEIGHT	5-19/32"	7-1/2"	9-7/16"	5-19/32"	7-1/2"	9-7/16"	5-19/32"	7-1/2"	9-7/16"
PLATE DIMENSION	4-1/2" x 3-15/16"			4-1/2" x 3-15/16"			4-1/2" x 3-15/16"		
HOLE DISTANCE	3-11/32" x 2-27/32"			3-11/32" x 2-27/32"			3-11/32" x 2-27/32"		
HOLE DIMENSION	7/16" x 3/4"			7/16" x 3/4"			7/16" x 3/4"		
Ø	1	1	1	1	1	1	1	1	1
AVAILABLE	On Request	On Request	On Request	On Request	On Request	On Request	On Request	On Request	On Request

CARGO HANDLING



usa.urrea.com



# CORDLESS ELECTRIC POWER TOOLS

# 17



CLASS

TYPE

PAGE

BRAND



Power tool batteries and chargers	Power tool batteries and chargers	474	•	
	Cordless impact wrenches	474	•	
Cordless screwdriving power tools	Cordless screwdrivers	475	•	
	Cordless hammer drill	475	•	
Cordless grinding power tools	Cordless angle grinder	475	•	

[usa.urrea.com](http://usa.urrea.com)

We are constantly improving our products, that is why the information, characteristics and availability of them can change without prior notice.

## 20 V HEAVY-DUTY CORDLESS IMPACT WRENCHES

### 20 V LI-ION HEAVY-DUTY CORDLESS IMPACT WRENCHES

**20 V** VOLTAGE **LI-ION TECHNOLOGY** **BRUSHLESS MOTOR** **REVERSIBLE FUNCTION** **VARIABLE SPEED** **3 SPEED MODES**

URREA



NEW

**1"**  
DRIVE



LI1219

**3/4"**  
DRIVE



LI1213

**1/2"**  
DRIVE



LI1212

**1/2"**  
DRIVE



LI129

- 3-speed electronic selector with adjustable torque for a wider range of applications.
- Unrestricted mobility and easy access to hard-to-reach areas.
- Integrated LED work light for better visibility.
- Anti-slip, comfort-grip handle.
- Cord and hose free for better mobility.
- Ideal for high-torque jobs for bolts up to 1".



ITEM	LI1219	LI1213	LI1212	LI129
APPLICATION				
VOLTAGE	20 V - 8-0 Ah	20 V - 4-0 Ah	20 V - 4-0 Ah	20 V - 4-0 Ah
DRIVE	1"	3/4"	1/2"	1/2"
NO-LOAD SPEED	1= 0-1,000 r/min; 2= 0-1,500 r/min; 3= 0-1,900 r/min	1= 0-1,100 r/min; 2= 0-1,500 r/min; 3= 0-1,800 r/min	1= 0-1,000 r/min; 2= 0-1,500 r/min; 3= 0-1,800 r/min	1= 0-1,500 r/min; 2= 0-2,000 r/min; 3= 0-2,500 r/min
IMPACTS PER MINUTE	1= 0-1,400 2= 0-1,900 3= 0-2,400	1= 0-1,400; 2= 0-1,800; 3= 0-2,300	1= 0-1,400; 2= 0-1,800; 3= 0-2,300	1= 0-1,600; 2= 0-2,200; 3= 0-2,700
MAX TORQUE	1,900 Nm (1,401.4 ft-lb)	1,300 Nm (958.8 ft-lb)	1,200 Nm (885 ft-lb)	900 Nm (663.8 ft-lb)
RUN TIME	90 min/ 10	90 min/ 10	90 min/ 10	90 min/ 10
WEIGHT	4.5 kg (9.92 lb)	3.58 kg (7.89 lb)	3.48 kg (7.67 lb)	2.58 kg (5.69 lb)
⊞	1	1	1	1
AVAILABLE	On Request	On Request	On Request	On Request

### 20 V CHARGER AND BATTERIES

**20 V** VOLTAGE **FAST CHARGING**



CAI25

**LI-ION TECHNOLOGY** **FAST CHARGING**



BAI208

**LI-ION TECHNOLOGY** **FAST CHARGING**



BAI204

URREA



NEW

- Charger and batteries are only compatible with designated items.



ITEM	DESCRIPTION	LI1219	LI1213	LI1212	LI129	⊞	AVAILABLE
CAI25	20 V 2.5A Battery Charger	•	•	•	•	1	On Request
BAI208	20 V 8.0Ah Lithium-Ion Battery	•	•	•	•	1	On Request
BAI204	20 V 4.0Ah Lithium-Ion Battery	•	•	•	•	1	On Request

## 18 V CORDLESS POWER TOOLS

### 18 V LITHIUM-ION 1/4" CORDLESS IMPACT DRIVER



ITEM	AI1018
APPLICATION	
VOLTAGE	18V - 2.4 Ah
SPINDLE / ARBOR SIZE	1/4"
NO-LOAD SPEED	1= 0-1,100; 2= 0-1,800; 3= 0-2,400
IMPACTS PER MINUTE	1= 0-1,100; 2= 0-2,600; 3= 0-3,200
MAX TORQUE	High: 200 Nm; Medium: 160 Nm; Low: 120 Nm
RUN TIME	30 min / 10 min
WEIGHT	1,1 kg (2,42 lb)
CONTENT	2 x 2.0 Ah Battery Packs 1 x Fast Charger 1 x Heavy-Duty Carrying Case
AVAILABLE	1 On Request

- 3-speed electronic torque selector for a wider range of applications
- Compact design for working in tight spaces
- Built-in LED work light
- Belt clip for convenient carrying
- Ideal for driving screws and bolts in metal, wood, or plastic surfaces

### 18 V LITHIUM-ION 4-1/2" – 5" CORDLESS ANGLE GRINDER



ITEM	EI1018
APPLICATION	
WHEEL CAPACITY	4-1/2", 5"
VOLTAGE	18V - 4 Ah
SPEED	10,000
SPINDLE THREAD	5/8"
DUTY CYCLE	30 min / 10 min
WEIGHT	1.57 kg (3.46 lb)
CONTENT	1 x 4.0 Ah Battery Pack 1 x Fast Charger 1 x Wrench for Disc Changes 1 x Side Handle 1 x Safety Guard 1 x Heavy-Duty Carrying Case
AVAILABLE	1 On Request

- Quick-release lock button for faster disc changes.
- Three-position adjustable side handle.
- Rapid charging system boosts productivity during operation.
- Ideal for grinding and cutting steel and stone.

### 18 V LITHIUM-ION 1/2" CORDLESS IMPACT WRENCH



ITEM	LI1018
APPLICATION	
VOLTAGE	18V - 2.4 Ah
DRIVE	1/2"
NO-LOAD SPEED	1= 0-1,500 r/min; 2= 0-2,000 r/min; 3= 0-2,600 r/min
IMPACTS PER MINUTE (IPM)	1= 0-1,800; 2= 0-2,600; 3= 0-3,300
MAX TORQUE	High: 350 Nm, Medium: 280 Nm, Low: 215 Nm
RUN TIME	30 min / 10 min
WEIGHT	1.1kg (2.42 lb)
CONTENT	2 x 2.0 Ah Battery Packs 1 x Fast Charger 1 x Heavy-Duty Carrying Case
AVAILABLE	1 On Request

- 3-Speed Electronic Selector delivers optimal torque for a wide range of applications.
- Lightweight Design reduces user fatigue during extended use.
- Integrated LED Work Light for enhanced visibility in low-light areas.
- Belt Clip for convenient on-the-job storage.
- Ideal for fastening and loosening standard and high-tensile bolts and nuts

### 18 V LITHIUM-ION 1/2" CORDLESS HAMMER DRILL



ITEM	RI1018
APPLICATION	
VOLTAGE	18V - 2.4 A
CHUCK	1/2" (13 mm)
MAX SPEED	1= 0-400 r/min 2= 0-1,400 r/min
TORQUE SETTINGS	21 + 3
MAX TORQUE	50 Nm
DUTY CYCLE	30 min / 10min
WEIGHT	1.2 kg (2,64lb)
CONTENT	2 x 2.0 Ah Battery Packs 1 x Fast Charger 6 x Drill Bits 6 x Driver Bits 1 x Bit Holder/Adapter 1 x Heavy-Duty Carrying Case
AVAILABLE	1 On Request

- 3-in-1 Functionality: hammer drill, drill, and screwdriver modes.
- Variable Speed Trigger for precise control.
- Keyless Quick-Change Chuck for fast bit swaps.
- Integrated LED Work Light improves visibility in dim work areas.
- Belt Clip for convenient access and storage.
- Ideal for drilling into hard materials.

### 18 V CHARGER AND BATTERY



CA18U



BA18U



VIDEO

- Charger and batteries are only compatible with designated items.

ITEM	DESCRIPTION	RI1018	EI1018	LI1018	AI1018	AVAILABLE
CA18U	Universal Charger 18V 2.4A	•	•	•	•	1 On Request
BA18U	18V 4.0 Ah Li-Ion Battery Pack	•	•	•	•	1 On Request

## 20 V CORDLESS POWER TOOLS

### 20 V LITHIUM-ION 1/4" CORDLESS IMPACT DRIVERS



ITEM	AI820
APPLICATION	INDUSTRIAL DUTY
VOLTAGE	20 V - 2.0 Ah
DRIVE	1/4"
NO-LOAD SPEED	1=0-1,600 r/min 2=0-2,000 r/min 3=0-2,500 r/min
IMPACTS PER MINUTE (IPM)	1=0-1,800 2=0-2,500 r/min 3=0-3,300 r/min
MAX TORQUE	280 Nm
DUTY CYCLE	40 min/ 10 min
WEIGHT	1,45 kg (3,19 lb)
INCLUDES	2 x 2.0 Ah Battery Packs 1 x Fast Charger 1 x Heavy-Duty Carrying Case
⊞	1
AVAILABLE	On Request

- 3-Speed Electronic Selector delivers optimized torque and speed for a wider range of applications.
- Compact Design for working in tight spaces.
- Rapid Charging System boosts productivity by minimizing downtime.
- Built-In LED Work Light for improved visibility.
- Belt Clip for convenient carry and quick access.
- Ideal for Driving Screws and Fasteners into metal, wood, or plastic.

### 20 V LITHIUM-ION 1/2" CORDLESS IMPACT WRENCHES



ITEM	LI820
APPLICATION	INDUSTRIAL DUTY
VOLTAGE	20 V - 2.0 Ah
DRIVE	1/2"
NO-LOAD SPEED	1=0-2,400 r/min
IMPACTS PER MINUTE (IPM)	1=0-800 2=0-1600 3=0-2400 4=0-3200
MAX TORQUE	400 Nm
DUTY CYCLE	40 min/ 10 min
WEIGHT	1,5 kg (3,3 lb)
INCLUDES	2 x 2.0 Ah Battery Packs 1 x Fast Charger 1 x Heavy-Duty Carrying Case
⊞	1
AVAILABLE	On Request

- 3-Speed Electronic Selector optimizes torque and speed for a broad range of applications.
- Friction Ring with Retaining Pin ensures secure socket retention.
- Rapid Charging System increases productivity by reducing downtime.
- Built-In LED Work Light for enhanced visibility in low-light conditions.
- Belt Clip for convenient carry and quick tool access.
- Ideal for Tightening and Loosening Standard or High-Strength Bolts and Nuts.

### 20 V LITHIUM-ION 1/2" CORDLESS IMPACT WRENCHES



ITEM	RI820
APPLICATION	INDUSTRIAL DUTY
VOLTAGE	20 V - 2.0 Ah
CHUCK SIZE	1/2"
MAX SPEED	1=0-450 r/min 2=0-2,000 r/min
TORQUE SETTINGS	21+3
MAX TORQUE	70 Nm
DUTY CYCLE	40 min/ 10 min
WEIGHT	1,6 kg (3,5 lb)
INCLUDES	2 x 2.0Ah Batteries 1 x 110-220 V Charger
⊞	1
AVAILABLE	On Request

- 3-in-1 Function: Hammer Drill, Drill, and Driver.
- Variable Speed Trigger for precise control.
- Keyless Quick-Change Chuck for faster bit swaps.
- Rapid Charging System boosts jobsite productivity.
- Built-in LED Work Light for improved visibility.
- Belt Clip for convenient carry.

### 20 V LITHIUM-ION 5" CORDLESS ANGLE GRINDERS



ITEM	EI820
APPLICATION	INDUSTRIAL DUTY
VOLTAGE	20 V - 4.0 Ah
WHEEL CAPACITY	5"
MAX SPEED	8,500 r/min
SPINDLE THREAD	7/8"
DUTY CYCLE	30 min/ 10 min
WEIGHT	2,25 kg (4,95 lb)
INCLUDES	1 x 4.0Ah Batteries 1 x 110-220 V Charger
⊞	1
AVAILABLE	On Request

- Designed for grinding and cutting steel and stone.
- Spindle lock button for quick wheel changes.
- 3-position adjustable auxiliary handle.
- Rapid charging system boosts productivity.

### 20 V BATTERIES & CHARGERS



- Battery charge indicator.

ITEM	DESCRIPTION	AI820	LI820	RI820	EI820	⊞	AVAILABLE
BA204	20 V 4.0Ah Li-Ion Battery	•	•	•	•	1	On Request

CORDLESS ELECTRIC POWER TOOLS



CLASS	TYPE	PAGE	BRAND	
Generators	Gasoline generators	478		

[usa.urrea.com](http://usa.urrea.com)

We are constantly improving our products, that is why the information, characteristics and availability of them can change without prior notice.

# 18 GASOLINE GENERATORS

## GASOLINE GENERATORS

### 13,000 W GASOLINE GENERATOR

**HEAVY DUTY** **13 000 W** **25 HP** **713 CC** **4-STROKE URREA ENGINE** **OHV OVERHEAD VALVE**

URREA  
HEAVY DUTY GENERATOR



NEW

ITEM	GG813
APPLICATION	
MAXIMUM OUTPUT	13,000 W
DISPLACEMENT	713 cc
OUTPUT VOLTAGE & FREQUENCY	120/240 V ~ 60 Hz
RUN TIME AT 50% LOAD	9 h
FUEL TANK CAPACITY	40 L / 10.5 gal
OIL CAPACITY	1.6 L / 0.42 gal
ENGINE POWER	25 HP
ENGINE SPEED	4 000 r/min
FUEL TYPE	Gasoline, 91 octane (or higher)
STARTING SYSTEM	Manual (recoil)/electric start
WEIGHT	176 Kg / 388 lb
	1
AVAILABLE	On Request



- Electric and recoil start button.
- Automatic low-oil shutdown.
- Battery-powered electric start system.
- Wheels and handle for enhanced portability.
- Smart idle: saves fuel with automatic efficiency idle when no load is applied

### 9,000 W GASOLINE GENERATOR

**HEAVY DUTY** **9 000 W** **17.5 HP** **457 CC** **4-STROKE URREA ENGINE** **OHV OVERHEAD VALVE**

URREA  
HEAVY DUTY GENERATOR



NEW

ITEM	GG890
APPLICATION	
MAXIMUM OUTPUT	9,000 W
DISPLACEMENT	457 cc
OUTPUT VOLTAGE & FREQUENCY	120/240 V ~ 60 Hz
RUN TIME AT 50% LOAD	8.5 h
FUEL TANK CAPACITY	25 L / 6.4 gal
OIL CAPACITY	1.2 L / 0.32 gal
ENGINE POWER	17.5 HP
ENGINE SPEED	3,600 r/min
FUEL TYPE	Gasoline, 91 octane (or higher)
STARTING SYSTEM	Manual (recoil)/electric start
WEIGHT	95 Kg / 209 lb
	1
AVAILABLE	On Request



- Electric and recoil start button for quick, reliable startups.
- Automatic low-oil shutdown to protect the engine.
- Battery-powered electric start system.
- Wheels and handle for enhanced portability.
- Smart idle feature saves fuel with automatic idle control when no load is applied

### 7,000 W GASOLINE GENERATOR

**HEAVY DUTY** **7 000 W** **15 HP** **420 CC** **4-STROKE URREA ENGINE** **OHV OVERHEAD VALVE**

URREA  
HEAVY DUTY GENERATOR



VIDEO

NEW

ITEM	GG870
APPLICATION	
MAXIMUM OUTPUT	7,000 W
DISPLACEMENT	420 cc
OUTPUT VOLTAGE & FREQUENCY	120/240 V ~ 60 Hz
RUN TIME AT 50% LOAD	9 h
FUEL TANK CAPACITY	25 L / 6.4 gal
OIL CAPACITY	1.1 L / 0.29 gal
ENGINE POWER	15 HP
ENGINE SPEED	3,600 r/min
FUEL TYPE	Gasoline, 91 octane (or higher)
STARTING SYSTEM	Manual (recoil)/electric start
WEIGHT	89 Kg / 196 lb
	1
AVAILABLE	On Request



- Electric and recoil start button for quick, reliable startups.
- Automatic low-oil shutdown to protect the engine.
- Battery-powered electric start system.
- Wheels and handle for enhanced portability.
- Smart idle feature saves fuel with automatic idle control when no load is applied.

### 3,000 W GASOLINE GENERATOR

**HEAVY DUTY** **3 000 W** **7.5 HP** **212 CC** **4-STROKE URREA ENGINE** **OHV OVERHEAD VALVE**

URREA  
HEAVY DUTY GENERATOR



NEW

ITEM	GG835A
APPLICATION	
MAXIMUM OUTPUT	3,000 W
DISPLACEMENT	212 cc
OUTPUT VOLTAGE & FREQUENCY	120 V ~ 60 Hz
RUN TIME AT 50% LOAD	15.9 h
FUEL TANK CAPACITY	15 L / 4 gal
OIL CAPACITY	0.6 L / 0.16 gal
ENGINE POWER	7.5 HP
ENGINE SPEED	3,600 r/min
FUEL TYPE	Gasoline, 91 octane (or higher)
STARTING SYSTEM	Manual (recoil)
WEIGHT	42 Kg / 92 lb
	1
AVAILABLE	On Request



- Recoil start.
- Automatic low-oil shutdown.
- Smart Idle: saves fuel with automatic idle control when no load is applied.





CLASS	TYPE	PAGE	BRAND	
			URREA	SURTEK
Pneumatic/air accessories	Pneumatic/air accessories	480	•	•
	Reciprocating air saw	483	•	
Pneumatic tools	Pneumatic nailers and staplers	483	•	•
	Nails and staples	484	•	•
	Air nibblers	486	•	
	Air Screwdrivers with torque control	487	•	
	Angle air grinders	489	•	
	Pneumatic grinders	489	•	
	Pneumatic grease gun	490	•	
	Air sanders	490	•	•
	Air hammers	493	•	•
	Air ratchets	494	•	•
	Pneumatic moto-tool	496	•	•
	Impact wrench	497	•	•
	Paint spray guns	507	•	•
	Air polisher	510	•	
	Air riveter	510	•	
	Air drills	511	•	•

[usa.urrea.com](http://usa.urrea.com)

We are constantly improving our products, that is why the information, characteristics and availability of them can change without prior notice.

## PNEUMATIC/AIR ACCESSORIES

### PNEUMATIC ACCESSORIES SET

PROFESSIONAL USE



17  
PIECES



Content	
108117	1/4" NPT Air blow gun 1
	3/16" NPT Security valve 1
	3/16" - 1/8" NPT male-female reducer adapter 1
	1/8" NPT Brass cone nozzle 1
108127	1/8" needle valve 1
	1/4" NPT Double nipple 2
	1/4" NPT double coupler 1
108122	1/4" NPT male quick connector 4
108121	1/4" NPT female quick connector 2
108125	1/4" NPT female quick coupler 1
	Gauge 1
108112	1/4" male quick connector 1



ITEM	PIECES	AVAILABLE
108141	17	✓

### PNEUMATIC ACCESSORIES WITH SPRING HOSE

PROFESSIONAL USE



14  
PIECES



Content	
108151	1/4" NPT x 25 ft (7.5 m) Spring hose 1
108125	1/4" NPT female quick coupler 2
	1/4" NPT double nipple 1
	1/4" NPT double coupler 1
	3/16" NPT rubber/ brass nozzle 1
108127	1/8" NPT needle valve 1
	3/16" - 1/8" NPT male-female reducer adapter 1
108111	1/4" NPT female inflator valve 1
108117	1/4" NPT air blow gun 1
108122	1/4" male quick connector 2
108121	1/4" NPT female quick connector 2



ITEM	PIECES	AVAILABLE
108142	14	✓

### PNEUMATIC ACCESSORIES SET

PROFESSIONAL USE



7  
PIECES



Content	
	3/16" NPT security valve 1
108127	1/8" NPT needle valve 1
	3/16" - 1/8" NPT male-female reducer adapter 1
	1/8" NPT brass cone nozzle 1
	3/16" NPT rubber/ brass nozzle 1
108117	1/4" NPT air blow gun 1
	1/8" NPT nozzle extension 1



ITEM	PIECES	AVAILABLE
108140	7	✓

### PNEUMATIC ACCESSORIES SET

PROFESSIONAL USE



4  
PIECES



Content	
108127	5/16" - 3/2" needle valve 1
	1/8" NPT - 5/15" 3/2" Air blow gun (M-F) adapter 1
	5/16" - 3/2" brass cone nozzle 1
	1/8" NPT inflator valve 1



ITEM	PIECES	AVAILABLE
108108	4	6

### AIR BLOW GUN SET

PROFESSIONAL USE



6  
PIECES



Content	
	1/8" NPT nozzle with nozzle extension 3
	1/8" NPT plastic cone nozzle 1
	1/8" NPT nozzle without nozzle extension 1
108117	1/4" - 1/8" NPT Air blow gun 1



ITEM	PIECES	AVAILABLE
108109	6	6

### HOSE ACCESSORIES

PROFESSIONAL USE



6  
PIECES



Content	
	1/4" NPT X 3/8" Tube fitting to male 1
	3/8" (9.5 mm) Double fitting hose connector 1
108111	1/4" NPT male quick connector 1
	#4 clamps 3



ITEM	PIECES	AVAILABLE
108104	6	6

### QUICK CONNECTORS AND COUPLERS SET

PROFESSIONAL USE



5  
PIECES



Content	
108122	1/4" NPT male quick connector 4
108125	1/4" NPT female quick connector 1



ITEM	PIECES	AVAILABLE
108126	5	6

### QUICK CONNECTORS AND COUPLERS SET

PROFESSIONAL USE



4  
PIECES



Content	
108122	1/4" NPT male quick connector 1
108121	1/4" NPT female quick connector 1
108125	1/4" NPT female quick connector 1
108124	1/4" NPT male quick connector 1



ITEM	PIECES	AVAILABLE
108123	4	6

### 1/4" NPT DOUBLE HEAD INFLATOR VALVE

PROFESSIONAL USE



- Allows air pressure to be supplied at multiple angles.
- Long aluminum body with dual solid-brass heads.
- 1/4" NPT threaded connection



ITEM	TYPE	AVAILABLE
108112	Double head	10

PNEUMATIC/AIR ACCESORIES

1/4" NPT INFLATOR VALVE WITH CLIP



- Clip for securing the valve to the stem.
- 1/4" threaded connection.
- Constructed from steel and brass.

ITEM	TYPE	⊞	AVAILABLE
108107	Female	6	✓

1/4" NPT INFLATOR VALVE



- Fits most tire valves.
- 1/4" NPT threaded connection.
- Solid brass construction.

ITEM	TYPE	⊞	AVAILABLE
108111	Female	6	✓
108110	Male	6	✓

1/4" NPT HOSE CONNECTOR



- 360° swivel.
- Bidirectional design.
- Helps reduce arm fatigue caused by rigid hoses.
- Maximizes hose service life.

ITEM	DESCRIPTION	⊞	AVAILABLE
108100	Male-female	5	✓

1/4" NPT BRONZE QUICK CONNECTION COUPLE



108124 108125

- Industrial design.
- Ideal for all types of air-powered tools.

ITEM	TYPE	⊞	AVAILABLE
108124	Male	1	✓
108125	Female	1	✓

1/4" NPT ZINC QUICK CONNECTOR



108121 108122

- Industrial design.
- Ideal for all types of pneumatic tools.

ITEM	TYPE	⊞	AVAILABLE
108121	Female	12	✓
108122	Male	12	✓

1/4" NPT BRASS CONNECTOR



108105 108106

Content	
A (HEX)	B
108105	9/16" 23 mm
108106	5/8" 23 mm

ITEM	TYPE	⊞	AVAILABLE
108105	Male	6	✓
108106	Female	6	✓

AIR FILTERS, REGULATORS-LUBRICATORS



- Drip regulator for controlling oil fluids.



- Pressure gauge with reading in psi and MPa.



- UPWL2
- Pressure range: 0.5 to 8.5 kg/cm<sup>2</sup>.

ITEM	CONNECTION	FLOW	⊞	AVAILABLE
UPWL2	1/4" NPT	500 l/min	1	On Request
UPWL3	3/8" NPT	1,700 l/min	1	On Request
UPWL4	1/2" NPT	3,000 l/min	1	On Request
UPWL6	3/4" NPT	3,000 l/min	1	On Request

1/4" NPT HEAVY DUTY INFLATOR



- Max pressure: 220 psi.
- Zamak body.
- Pressure release valve.
- 1/4" NPT thread.
- Dual head.

ITEM	TYPE	⊞	AVAILABLE
108113	Female 1/4" NPT	1	On Request

OIL AND WATER SEPARATOR FILTER



- Essential for separating and filtering water and oil particles from the pneumatic line.
- Manual drain valve.
- Assembles into the air connection with 1/4" NPT male inlet and female outlet.

ITEM	CONNECTION	⊞	AVAILABLE
108103	1/4" NPT	6	✓

AIR REGULATOR WITH PRESSURE GAUGE



- Air inlet: 1/4" NPT.
- Anodized aluminum body.
- Dual measurement scales: psi and bar.
- Seal-free design.
- Durable, corrosion-resistant brass connector.

ITEM	CAPACITY	⊞	AVAILABLE
UPR2	140 psi	1	On Request

## PNEUMATIC/AIR ACCESSORIES

### AIR FLOW REGULATOR



- Air inlet: 1/4" NPT.
- Aluminum body



ITEM	CAPACITY	☐	AVAILABLE
108101	0 - 160 psi	1	✓

### 1/4" NPT AIR BLOW GUN



- 3" nose length.



108114



108117

- Non-slip trigger.
- Hanging hook with finger guard.



ITEM	TYPE	☐	AVAILABLE
108114	Female	1	✓
108117	Female	1	✓

### AIR HOSES

#### REINFORCED PVC HIGH PRESSURE AIR HOSES



108157



- Made from highly flexible rubber.
- Reinforced fittings for extended hose life.
- Withstands high air pressures up to 380 psi



ITEM	LENGTH	DIAMETER	CONNECTION	☐	AVAILABLE
108156	32.8 ft	1/2"	3/8" NPT	1	✓
108157	49.2 ft	1/2"	3/8" NPT	1	✓

#### HIGH PRESSURE AIR HOSES



108150

- Resistant to high air pressure up to 380 psi



ITEM	LENGTH	DIAMETER	CONNECTION	☐	AVAILABLE
108148	24.6 ft	3/8"	1/4" NPT	1	✓
108149	32.8 ft	3/8"	1/4" NPT	1	✓
108150	49.2 ft	3/8"	1/4" NPT	1	✓

#### LOW PRESSURE AIR HOSES



108147

- Resistant to air pressure up to 284 psi.
- Made of durable rubber.



ITEM	LENGTH	CONNECTION	☐	AVAILABLE
108145	16.4 ft	1/4" NPT	1	✓
108146	32.8 ft	1/4" NPT	1	✓
108147	49.2 ft	1/4" NPT	1	On Request

#### AIR SPRING HOSES



108151

- Anti-torsion metal spring to prevent breakage and reduce wear.
- Withstands up to 200 psi pressure.



ITEM	DIAMETER X LENGTH	CONNECTION	☐	AVAILABLE
108151	1/4" x 25' (24.6 ft)	1/4" NPT	1	✓
108152	1/4" x 50' (49.2 ft)	1/4" NPT	1	✓
108153	3/8" x 25' (24.6 ft)	1/4" NPT	1	On Request
108154	3/8" x 50' (49.2 ft)	1/4" NPT	1	✓

**RECIPROCATING AIR SAW**

**RECIPROCATING AIR SAW**



**9 000 CPM** ((dB) **90** DB  
STROKES PER MINUTE

**URREA**  
SUPER DUTY POWERED TOOL



**UP881**



**UP88135A**

- Adjustable guard/guide allows operator to set cutting depth
  - Vibration-reducing mechanism
  - Safety lever prevents accidental start-up
- Improved product will be supplied according to inventory rotation.*

ITEM	UP881
APPLICATION	
STROKES PER MINUTE	9,000
OVERALL LENGTH	9"
AIR CONSUMPTION	10 SCFM
WORKING PRESSURE	90 psi
AIR INLET	1/4" NPT
WEIGHT	0.6 kg
	1
AVAILABLE	✓

**Replacement**

ITEM	DESCRIPTION		AVAILABLE
UP88135A	Saw blade 32 teeth	5	✓

**BULK**

**PNEUMATIC NAILERS AND STAPLERS**

**PNEUMATIC NAILER**



**MAGNESIUM HOUSING**

**LIGHT-WEIGHT**

**URREA**  
SUPER DUTY POWERED TOOL



ITEM	CN963
USE	
GAUGE	16 GA
NAIL / STAPLE LENGTH	3/4" - 2-1/2"
MAGAZINE CAPACITY	100 nails
MAXIMUM AIR PRESSURE	120 psi
REQUIRED AIR PRESSURE	70-100 psi
AIR CONSUMPTION	
AIR INLET	1/4" NPT
WEIGHT	1.7 kg
<b>INCLUDES</b>	
1 KEY	•
1 OIL CONTAINER	•
	1
AVAILABLE	✓

- Magnesium die-cast housing for reduced weight.
- Depth adjustment wheel for precise control.
- 100-nail magazine capacity.
- 360° adjustable air exhaust system.
- Quick jam release for fast clearing.

**PNEUMATIC NAILERS AND STAPLERS**



**CE632**



**CN650**

- Strong yet lightweight aluminum body with die-cast construction.
- Multi-directional exhaust port directs air away from operator and work surface.
- Jam-free mechanism designed to prevent staple blockage.
- 360° adjustable air exhaust system.

- Die-cast aluminum housing for reduced weight.
- Quick-release nose for fast nail jam clearing.
- 360° adjustable air exhaust system.

ITEM	CE632	CN650
USE		
CROWN	7/32"	N/A
GAUGE	18 GA	18 GA
NAIL / STAPLE LENGTH	5/8" - 1 1/4"	3/8"-2"
MAGAZINE CAPACITY	100 nails / 85 staples	100 nails
MAXIMUM AIR PRESSURE	120 psi	120 psi
REQUIRED AIR PRESSURE	70-100 psi	70-100 psi
AIR CONSUMPTION	1.18 CFM	1.3 CFM
AIR INLET	1/4" NPT	1/4" NPT
WEIGHT	1.3 kg	1.55 kg
<b>INCLUDES</b>		
1 KEY	•	•
1 OIL CONTAINER	•	•
	1	1
AVAILABLE	On Request	On Request



**SURTEK**  
TOOLS FOR SPECIALISTS

PNEUMATIC TOOLS

## PNEUMATIC BRAD NAILS

### PNEUMATIC BRAD NAILS

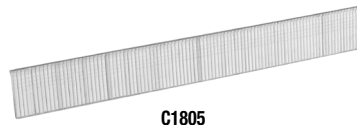

C1805

- Head size: 5/64"
- Made of high-hardness steel.
- Strong penetration: T-shaped head design and chisel point provide excellent penetration, ensuring smooth operation without jams, buckling, or interruptions.
- 18 gauge for extra strength.
- 5,000 pieces per box.



ITEM	LENGTH	HEAD	GAUGE	QUANTITY	☞	AVAILABLE
C1805	5/8"	5/64"	18	5,000	1	On Request
C1806	3/4"	5/64"	18	5,000	1	On Request
C1808	1"	5/64"	18	5,000	1	On Request
C1810	1-1/4"	5/64"	18	5,000	1	On Request
C1816	2"	5/64"	18	5,000	1	On Request

### NAILS FOR PNEUMATIC NAILERS



- Head size: 5/64"
- Ideal for Surtek pneumatic nailers.
- 18 gauge for extra strength.
- 5,000 pieces per box.



ITEM	LENGTH	HEAD	GAUGE	QUANTITY	☞	AVAILABLE
108499	3/8"	5/64"	18	5,000	1	On Request
108500	19/32"	5/64"	18	5,000	1	On Request
108501	13/16"	5/64"	18	5,000	1	On Request
108502	1"	5/64"	18	5,000	1	On Request
108503	1-3/16"	5/64"	18	5,000	1	On Request
108504	1-1/4"	5/64"	18	5,000	1	On Request
108505	1-3/8"	5/64"	18	5,000	1	On Request
108506	1-5/8"	5/64"	18	5,000	1	On Request
108507	1-3/4"	5/64"	18	5,000	1	On Request
108508	2"	5/64"	18	5,000	1	On Request

## PNEUMATIC STAPLERS

### COIL NAILS FOR PNEUMATIC NAILERS



- Higher elongation rate of 23.2% allows nails to absorb impact before breaking.
- Hardness: 54 HRC.
- Ø 0.099"
- Sold per case of 24 coils.
- Each coil contains 300 nails.



ITEM	LENGTH	GAUGE	QUANTITY	☞	AVAILABLE
CR175	1-3/4"	12	300	1	On Request
CR200	2"	12	300	1	On Request
CR250	2-1/2"	12	300	1	On Request

PNEUMATIC STAPLERS

PNEUMATICS STAPLERS

MAGNESIUM HOUSING LIGHT-WEIGHT

URREA



EN950



EN938



EN916

- Magnesium die-cast housing reduces overall weight.
- Quick-release mechanism for fast staple clearing.
- 360° adjustable exhaust system.



- Depth adjustment wheel for precise control.



- Single-load quick reloading system.



ITEM	EN950	EN938	EN916
USE			
CROWN	7/16"	1/4"	3/8"
GAUGE	16 GA	18 GA	22 GA
STAPLE LENGTH	1" - 2"	1/2" - 1-9/16"	5/32" - 5/8"
MAGAZINE CAPACITY	100 staples	100 staples	185 staples
MAX. PRESSURE	120 psi	120 psi	120 psi
AIR PRESSURE	70-100 psi	70-100 psi	70-100 psi
AIR CONSUMPTION	1.7 CFM	1.7 CFM	1.7 CFM
WEIGHT	4,3 lb (1,94 kg)	2,9 lb (1,34 kg)	1,7 lb (0,8 kg)
SEQUENTIAL FIRE	•	•	-
<b>ACCESSORIES</b>			
SAFETY GLASSES	•	•	-
HEX KEYS	2	2	2
LUBRICANT BOTTLE	•	•	•
	1	1	1
AVAILABLE	On Request	✓	✓

PNEUMATIC NAILERS AND STAPLERS

PROFESSIONAL USE ALUMINUM HOUSING LIGHT-WEIGHT

SURTEK TOOLS FOR SPECIALISTS



NEW



EN650A

ITEM	EN650A
USE	
CROWN	7/16"
GAUGE	16 GA
NAIL/STAPLE LENGTH	3/8" - 2"
MAGAZINE CAPACITY	50 staples
MAX. AIR PRESSURE	120 psi
REQUIRED AIR PRESSURE	70 - 100 psi
AIR CONSUMPTION	1.65 CFM
AIR INLET	1/4" NPT
WEIGHT	4.85 lb (2.2 kg)
<b>ACCESSORIES</b>	
1 WRENCH	•
1 OIL BOTTLE	•
1 SAFETY GLASSES	•
	1
AVAILABLE	On Request

- Easy staple lock opening for quick one-hand loading.
- Die-cast aluminum housing to reduce weight.

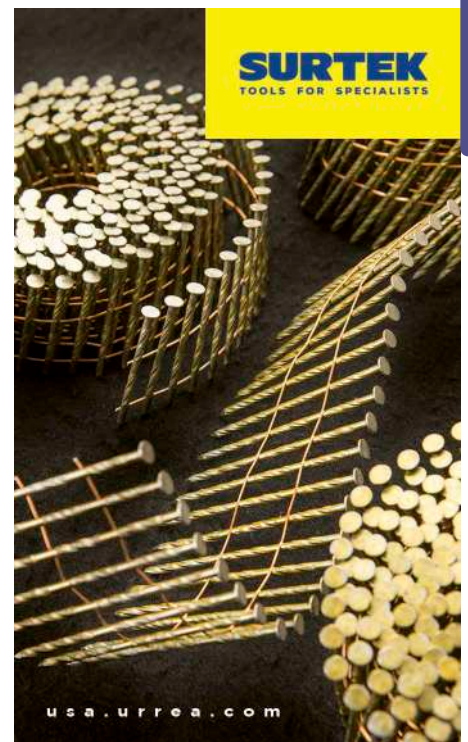

usa.urrea.com

## PNEUMATIC STAPLERS

### STAPLES FOR PNEUMATIC STAPLERS

**SUPER DUTY** **HIGH-HARDNESS STEEL**  
RESISTANT TO DEFORMATION

URREA



G1612



ITEM	CROWN	LENGTH	GAUGE	STAPLES	☞	AVAILABLE
G1610	7/16"	1-1/4"	16	10,000	1	On Request
G1612	7/16"	2"	16	10,000	1	On Request
G1804	1/4"	1/2"	18	5,000	1	On Request
G1805	1/4"	5/8"	18	5,000	1	On Request
G1806	1/4"	3/4"	18	5,000	1	On Request
G1808	1/4"	1"	18	5,000	1	On Request
G1810	1/4"	1-1/4"	18	5,000	1	On Request
G1812	1/4"	1-1/2"	18	5,000	1	On Request
G2202	3/8"	1/4"	22	10,000	1	On Request
G2205	3/8"	5/8"	22	10,000	1	On Request

### STAPLES FOR PNEUMATIC STAPLERS

**PROFESSIONAL USE**

SURTEK



108512



ITEM	CROWN	LENGTH	GAUGE	STAPLES	☞	AVAILABLE
108528	3/8"	1/4"	22	5,000	1	On Request
108510	1/4"	3/8"	18	5,000	1	On Request
108511	1/4"	1/2"	18	5,000	1	On Request
108512	1/4"	5/8"	18	5,000	1	On Request
108513	1/4"	3/4"	18	5,000	1	On Request
108514	1/4"	7/8"	18	5,000	1	On Request
108515	1/4"	1"	18	5,000	1	On Request
108527	1/4"	1-1/4"	18	5,000	1	On Request
108530	1/2"	2"	16	10,000	1	On Request

## AIR NIBBLERS

### AIR NIBBLER

**HEAVY DUTY** **2 600 CPM** ((dB) **86**  
CUTS PER MINUTE DB

URREA



ITEM	UP835
USE	<b>HEAVY DUTY</b>
STROKES PER MINUTE	2,600
AIR CONSUMPTION	4 SCFM
WORKING PRESSURE	90 psi
AIR INLET	1/4" NPT
WEIGHT	1.98 lb (0.9 kg)
☞	1
AVAILABLE	✓

- Lightweight and compact design allows one-handed operation.
- Lever trigger for easy handling.
- Ideal for cutting plastic and sheet metal.

### AIR SCISSORS

**HEAVY DUTY** **2 200 CPM**  
CUTS PER MINUTE  
**1.5 mm** **MAXIMUM CUTTING THICKNESS** ((dB) **98**  
DB

URREA



**IMPROVED PRODUCT**



ITEM	UP785S
USE	<b>HEAVY DUTY</b>
STROKES PER MINUTE	2,200
AIR CONSUMPTION	30 SCFM
WORKING PRESSURE	90 psi
AIR INLET	1/4" NPT
WEIGHT	2.86 lb (1.3 kg)
☞	1
AVAILABLE	✓

- Lightweight and compact design allows one-handed operation
  - Ideal for cutting angles, frames, or circles in plastics, aluminum, and steel
- Improved product will be supplied according to inventory rotation.*



AIR NIBBLERS

PNEUMATIC CUTTER

HEAVY DUTY **3" WHEEL DIAMETER ((dB) 98 DB)**



- Safety lock throttle lever.
- Lightweight and compact design for one-handed operation.
- Adjustable guard for disc protection.
- Ideal for cutting sheet metal, fiberglass, bolts, clamps, exhaust pipe brackets, grinding areas, and rough edges.

Improved product will be supplied according to inventory rotation.

URREA

CUTTING WHEEL FOR PNEUMATIC CUTTER UP874

URREA

HEAVY DUTY

IMPROVED PRODUCT



ITEM	UP874
USE	HEAVY DUTY
NO LOAD SPEED	20,000 rpm
WHEEL DIAMETER	3"
AIR CONSUMPTION	30 SCFM
WORKING PRESSURE	90 psi
AIR INLET	1/4" NPT
WEIGHT	1.32 lb (0,6 kg)
⊞	1
AVAILABLE	✓

ITEM	DESCRIPTION	⊞	AVAILABLE
UP87430	Wheel 3/8" spindle x 1/16" thickness	10	✓

BULK

AIR SCREWDRIVERS WITH TORQUE CONTROL

STRAIGHT AIR TORQUE SCREWDRIVER

HEAVY DUTY **REVERSIBLE FUNCTION** **0.4 - 3.5 NM TORQUE RANGE** **90 PSI WORKING PRESSURE** **1,400 r/min MOTOR SPEED**

URREA

ITEM	UPTC30A
USE	HEAVY DUTY
HEX DRIVE	1/4"
NO-LOAD SPEED	1,400 rpm
TORQUE	0.4 - 3.5 Nm
CLUTCH TYPE	Adjustable
AIR CONSUMPTION	12.4 SCFM
AIR PRESSURE	90 psi
AIR INLET	1/4" NPT
WEIGHT	1.3 lb (0.59 kg)
⊞	1
AVAILABLE	✓

- Soft-grip rubber handle for slip resistance.
- Forward/reverse switch.
- Pressure-activated trigger.



STRAIGHT AIR TORQUE SCREWDRIVER

HEAVY DUTY **REVERSIBLE FUNCTION** **0.4 - 4.5 NM TORQUE RANGE** **90 PSI WORKING PRESSURE** **950 r/min MOTOR SPEED**

URREA

ITEM	UPTC40A
USE	HEAVY DUTY
HEX DRIVE	1/4"
NO-LOAD SPEED	950 rpm
TORQUE	0.4 - 4.5 Nm
CLUTCH TYPE	Adjustable
AIR CONSUMPTION	10.6 SCFM
AIR PRESSURE	90 psi
AIR INLET	1/4" NPT
WEIGHT	1.3 lb (0.6 kg)
⊞	1
AVAILABLE	✓

- Ergonomic soft-grip handle for superior comfort and control.
- Forward/Reverse switch for versatile operation.





## AIR SCREWDRIVERS WITH TORQUE CONTROL

### GUN-TYPE AIR TORQUE SCREWDRIVER



**0.4 - 4.5 NM** TORQUE RANGE
 
**90 PSI** WORKING PRESSURE
 
**950 r/min** MOTOR SPEED



ITEM	UPTC55A
USE	
HEX DRIVE	1/4"
NO-LOAD SPEED	950 rpm
TORQUE	0.4 - 4.5 Nm
CLUTCH TYPE	Adjustable
AIR CONSUMPTION	13.4 SCFM
AIR PRESSURE	90 psi
AIR INLET	1/4" NPT
WEIGHT	1.3 lb (0.6 kg)
	1
AVAILABLE	On Request



- Ergonomic soft-grip handle for comfort and control.
- Forward/Reverse switch for flexible operation.
- Trigger-activated design for precise control.





### AIR SCREWDRIVER



**8 NM** TORQUE RANGE
 
**90 PSI** WORKING PRESSURE
 
**1,800 r/min** MOTOR SPEED
 
**98** DB



ITEM	UP779
USE	
HEX DRIVE	1/4"
NO-LOAD SPEED	1,800 rpm
TORQUE	70 in-lb (8 Nm)
CLUTCH TYPE	Positive
AIR CONSUMPTION	25-30 SCFM
AIR PRESSURE	90 psi
AIR INLET	1/4" NPT
WEIGHT	2.4 lb (1.1 kg)
	1
AVAILABLE	✓



- Variable-speed trigger for optimal control.
- Quick-change chuck for fast bit swaps.
- Positive impact mechanism for consistent performance.
- Ergonomic soft-grip handle for comfort and stability.





### AIR SCREWDRIVER



**4 - 8 NM** TORQUE RANGE
 
**90 PSI** WORKING PRESSURE
 
**1,800 r/min** MOTOR SPEED
 
**98** DB



ITEM	UP780
USE	
HEX DRIVE	1/4"
NO-LOAD SPEED	1,800 rpm
TORQUE	35-70 in-lb (4-8 Nm)
CLUTCH TYPE	Adjustable
AIR CONSUMPTION	25-30 SCFM
AIR PRESSURE	90 psi
AIR INLET	1/4" NPT
WEIGHT	2.5 lb (1.15 kg)
	1
AVAILABLE	✓



- Variable-speed trigger for precise control.
- Quick-change chuck for fast and easy bit swaps.
- Adjustable impact mechanism for versatile applications.
- Ergonomic soft-grip handle for comfort and reduced fatigue.
- External clutch adjustment for working with different torque levels.
- Positive impact mechanism for consistent performance.

*Improved product will be supplied according to inventory rotation.*



AIR NEEDLE SCALER

AIR NEEDLE SCALER



- Tool designed for effective surface preparation.
- Adjustable hood allows positioning of the needles at the required distance for each application.

PARA PREPARACIÓN DE SUPERFICIES DE TRABAJO

- Cleaning of metallic structures before painting or eliminate old paint or debris before painting.
- Cleans the corners after welding.
- Cleans slag from welded surfaces.
- Elimination of spatter from soldering or welding.
- Removal of casting sand.



REPLACEMENT NEEDLES FOR NEEDLE SCALER



19  
PIECES

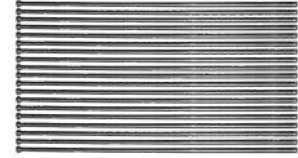

ITEM	PRESENTATION	AIR CONSUMPTION (SCFM)	☐	AVAILABLE
UP125	With 19 needles of 7", 4,600 impacts per minute	4 SCFM	1	✓

ITEM	PIECES	LENGTH	☐	AVAILABLE
UP125R046	19	7"	1	✓

ANGLE AIR GRINDERS

ANGLE AIR GRINDERS



ITEM	UP857
USE	
ARBOR HOLE	7/8"
WHEEL CAPACITY	7"
NO-LOAD SPEED	7,000 rpm
AIR CONSUMPTION	45 SCFM
WORKING PRESSURE	90 psi
AIR INLET	3/8" NPT
WEIGHT	6.17 lb (2.8 kg)
☐	1
AVAILABLE	✓



- Durable, lightweight aluminum alloy housing.
  - Protective safety guard.
  - Safety lock to prevent accidental activation.
- Improved product will be supplied according to inventory rotation.*

ANGLE AIR GRINDERS



ITEM	UP854
USE	
ARBOR HOLE	5/8"
WHEEL CAPACITY	4-1/2"
NO-LOAD SPEED	11,000 rpm
AIR CONSUMPTION	30 SCFM
WORKING PRESSURE	90 psi
AIR INLET	1/4" NPT
WEIGHT	3.9 lb (1.8 kg)
☐	1
AVAILABLE	✓



- Durable, lightweight aluminum alloy housing.
  - Protective safety guard.
  - Paddle switch for safe and comfortable operation.
- Improved product will be supplied according to inventory rotation.*

## ONE-HANDED PNEUMATIC GREASE GUN

### ONE-HANDED PNEUMATIC GREASE GUN



URREA



- Chrome-plated surface.
- One-hand operation for professional use.



ITEM	CAPACITY	MAXIMUM PRESSURE	🔒	AVAILABLE
2364	14 oz / 400 g	2,400-6,000 psi	1	✓

## AIR SANDERS

### AIR SANDER ROTO ORBITAL



URREA



ITEM	UP861A
USE	HEAVY DUTY
SANDPAPER SIZE	6"
ORBIT DIAMETER	3/16"
NO-LOAD SPEED	12,000 rpm
WORKING PRESSURE	90 psi
AIR CONSUMPTION	1.1 CFM
AIR INLET	1/4"
SPINDLE	5/16"
PAD SIZE	6"
PAD VACUUM HOLES	6
🔒	1
AVAILABLE	On Request



- Dust extraction system: central suction.
- Base with quick-change hook & loop fastening system.
- Ideal for surfaces requiring sanding and fine finishing without swirl marks.

### AIR SANDER ROTO ORBITAL



URREA



ITEM	UP890A
USE	HEAVY DUTY
SANDPAPER SIZE	6"
ORBIT DIAMETER	3/16"
NO-LOAD SPEED	12,000 rpm
WORKING PRESSURE	90 psi
AIR CONSUMPTION	1.1 CFM
AIR INLET	1/4"
SPINDLE	5/16"
PAD SIZE	6"
PAD VACUUM HOLES	0
🔒	1
AVAILABLE	✓



- Base with quick-change hook & loop fastening system.
- Ideal for surfaces requiring scraping and fine finishing without swirl marks.

**AIR SANDERS**

**DUAL ACTION SANDER**









URREA



ITEM	UP870A
USE	
SANDPAPER SIZE	6"
ORBIT DIAMETER	3/16"
NO-LOAD SPEED	10,000 rpm
WORKING PRESSURE	90 psi
AIR CONSUMPTION	1.56 CFM
AIR INLET	1/4"
SPINDLE	5/16"
PAD SIZE	6"
PAD VACUUM HOLES	0
	1
AVAILABLE	✓

- Smooth PSA vinyl base.
- Ideal for surfaces requiring scraping and fine finishing without swirl marks.



**AIR SANDER ROTO ORBITAL**





SURTEK



ITEM	LNR606
USE	
SANDPAPER SIZE	6"
NO-LOAD SPEED	10,000 rpm
WORKING PRESSURE	90 psi
AIR CONSUMPTION	6, 5 CFM
AIR INLET	1/4" NPT
SPINDLE	3/16"
PAD SIZE	6"
	1
AVAILABLE	On Request

- Quick-release base.
- Ideal for sanding wood and metal surfaces.





**AIR SANDER ROTO ORBITAL**





SURTEK



ITEM	LNR506
USE	
SANDPAPER SIZE	6"
NO-LOAD SPEED	10,000 rpm
WORKING PRESSURE	90 psi
AIR CONSUMPTION	4, 5 CFM
AIR INLET	1/4" NPT
SPINDLE	5/16"
PAD SIZE	6"
	1
AVAILABLE	✓

- Smooth base for self-adhesive sandpapers.
- Ideal for sanding wood and metal surfaces.



PNEUMATIC TOOLS

## AIR SANDERS

### AIR SANDER PADS



URREA  
IMPROVED PRODUCT



BL90A



BL61A



BL70A



UP800VI



UP800VE



ITEM	BL90A	BL61A	BL70A	UP800VI	UP800VE
DESCRIPTION	Hook & loop	Hook & loop	Vinyl	Vinyl	Hook & loop
MAX SPEED	12,000 rpm	12,000 rpm	11,000 rpm	12,000 rpm	12,000 rpm
VACUUM HOLES	-	6	-	-	-
FOR ITEM	UP890A	UP861A	UP870A	UP890	UP861
☞	1	1	1	1	1
AVAILABLE	On Request	On Request	On Request	✓	✓

### AIR SANDER ORBITAL



**1/3 SANDPAPER** → **UNIFORM MOTION** ((dB)) **107 DB**

URREA  
IMPROVED PRODUCT



PNEUMATIC TOOLS

ITEM	UP766
USE	
SANDPAPER SIZE	1/3 sheet
NO-LOAD SPEED	9,000 rpm
AIR CONSUMPTION	25 SCFM
WORKING PRESSURE	90 psi
AIR INLET	1/4" NPT
WEIGHT	3.9 lb (1.8 kg)
☞	1
AVAILABLE	✓



- Built-in power regulator valve
  - One-hand operation trigger
- Improved product will be supplied according to inventory rotation.*



### AIR SANDER ROTO ORBITAL



**1/2 SANDPAPER** → **UNIFORM MOTION**

SURTEK  
TOOLS FOR SPECIALISTS



ITEM	LN0512
USE	
SANDPAPER SIZE	1/2 sheet
NO-LOAD SPEED	9,000 rpm
WORKING PRESSURE	90 psi
AIR CONSUMPTION	4,5 CFM
AIR INLET	1/4" NPT
☞	1
AVAILABLE	On Request



AIR HAMMERS AND ACCESSORIES

AIR HAMMER AND CHISELS SET



7  
PIECES



ITEM	UP711K
STROKES PER MINUTE	3,200
AIR FLOW	25 SCFM
WORKING PRESSURE	90 psi
AIR INLET	1/4" NPT
<b>CONTENT</b>	
UP711	Pneumatic hammer
UP711K5	chisels ste
UP700	Quick connector
☐	1
AVAILABLE	✓

PNEUMATIC HAMMER AND 4 CHISELS SET



7  
PIECES



ITEM	MA534K
STROKES PER MINUTE	4,500
AIR FLOW	6,3 CFM
WORKING PRESSURE	90 psi
AIR INLET	1/4" NPT
<b>CONTENT</b>	
PNEUMATIC HAMMER	1
CHISELS	4
MINI LUBRICATION UNIT	1
QUICK CONNECTOR	1
☐	1
AVAILABLE	On Request



Chisel spring set	
ITEM	108131
PIECES	2
☐	10
AVAILABLE	On Request



AIR HAMMER



ITEM	UP715
USE	
BLOWS PER MINUTE	2,200
PISTON STROKE	100 mm
PISTON DIAMETER	3/4"
AIR CONSUMPTION	25 SCFM
WORKING PRESSURE	90 PSI
AIR INLET	1/4" NPT
WEIGHT	4.18 lb (1.9 kg)
☐	1
AVAILABLE	✓



- Ergonomic soft-grip handle
  - Integrated silencer to minimize exhaust noise
- Improved product will be supplied according to inventory rotation.*



PNEUMATIC TOOLS

AIR HAMMER



ITEM	UP711
USE	
BLOWS PER MINUTE	3,500
PISTON STROKE	64 mm
PISTON DIAMETER	3/4"
AIR CONSUMPTION	25 SCFM
WORKING PRESSURE	90 PSI
AIR INLET	1/4" NPT
WEIGHT	3.5 lb (1.6 kg)
☐	1
AVAILABLE	✓



- Ergonomic soft-grip handle.
  - Short piston stroke.
- Improved product will be supplied according to inventory rotation.*



## AIR HAMMERS

### CHISELS FOR AIR HAMMER



**5**  
PIECES



ITEM	LENGTH	PIECES	⊞	AVAILABLE
UP711K5	7"	5	1	✓

### TAPERED PUNCH CHISELS



**86MN4**  
Straight chisel.



**86MN5**

ITEM	LENGTH	⊞	AVAILABLE
86MN4	7"	6	✓
86MN5	7"	6	✓

### QUICK CHANGE RETAINER



- Secure retention by simply pulling the outer collar and inserting the chisel.
- Allows fast and easy chisel changes.

ITEM	DESCRIPTION	⊞	AVAILABLE
UP700	Quick change retainer coupler for air hammers	1	✓

## 3/8" DRIVE SOCKET SETS AND AIR RATCHETS

### AIR RATCHET SET WITH SOCKETS IN INCHES



**14**  
PIECES

Content	
Sockets	
7208H	1/4"
7214H	7/16"
7216H	1/2"
7218H	9/16"
7220H	5/8"
7222H	11/16"
7224H	3/4"

Content	
Deep sockets	
7710H	5/16"
7712H	3/8"
7714H	7/16"
7716H	1/2"
7718H	9/16"
7722H	11/16"

Content	
Accessories	
UP886	Matraca 3/8"



ITEM	PIECES	⊞	AVAILABLE
UP886K	14	1	✓

### AIR RATCHET SET WITH SOCKETS IN METRICS



**17**  
PIECES

Content	
Sockets	
7213M	13 mm
7214M	14 mm
7215M	15 mm
7216M	16 mm
7217M	17 mm
7218M	18 mm
7219M	19 mm

Content	
Deep sockets	
7008M	8 mm
7009M	9 mm
7010M	10 mm
7011M	11 mm
7013M	13 mm
7014M	14 mm
7015M	15 mm
7017M	17 mm
7021M	21 mm

Content	
Accessories	
UP886	Matraca 3/8"



ITEM	PIECES	⊞	AVAILABLE
UP886KM	17	1	On Request

### 3/8" AIR RATCHET



URREA



ITEM	UP886
USE	
SQUARE DRIVE	3/8"
NO-LOAD SPEED	150 rpm
MAX TORQUE	65 ft-lb (88 Nm)
AIR CONSUMPTION	20-25 scfm
WORKING PRESSURE	90 psi
AIR INLET	1/4" NPT
WEIGHT	2.4 lb (1.1 kg)
⊞	1
AVAILABLE	✓

- Compact head design provides greater flexibility in tight areas.
- Easy to maneuver when changing directions.
- Enhanced gear set for superior durability.
- Ideal for installing or removing spark plugs, radiators, water pumps, exhaust systems, and more.

Improved product will be supplied according to inventory rotation.





1/2" DRIVE SOCKET SETS AND AIR RATCHETS

FLEXIBLE HEAD AIR RATCHET SET WITH SOCKETS IN SAE



12  
PIECES



Content	
Sockets	
7412H	3/8"
7414H	7/16"
7416H	1/2"
7418H	9/16"
7420H	5/8"
7422H	11/16"
7424H	3/4"

Content	
Accessories	
UP886H	1/2" air ratchet
7324H	3/4" 2" extension
7326H	13/16" 5" extension

ITEM	PIECES	AVAILABILITY
UP886HK	12	1 AVAILABLE ✓

FLEXIBLE HEAD AIR RATCHET SET WITH SOCKETS IN METRICS



12  
PIECES



Content	
Sockets	
7410M	10 mm
7412M	12 mm
7413M	13 mm
7414M	14 mm
7415M	15 mm
7416M	16 mm
7417M	17 mm

Content	
Accessories	
UP886H	1/2" air ratchet
7317M	17 mm 2" extension
7321M	21 mm 5" extension

ITEM	PIECES	AVAILABILITY
UP886HKM	12	1 AVAILABLE On Request

1/2" FLEXIBLE HEAD AIR RATCHET



ITEM	UP886H
USE	
SQUARE DRIVE	1/2"
NO-LOAD SPEED	150 rpm
MAX TORQUE	65 ft-lb (88 Nm)
AIR CONSUMPTION	20-25 SCFM
WORKING PRESSURE	90 psi
AIR INLET	1/4" NPT
WEIGHT	2.4 lb (1.1 kg)
AVAILABILITY	1 AVAILABLE ✓



- Compact head design for maximum flexibility in tight areas.
  - Easy to maneuver when changing directions.
  - Upgraded gear set for long-lasting durability.
  - Ideal for installing or removing spark plugs, radiators, water pumps, exhaust systems, and more.
- Improved product will be supplied according to inventory rotation.*



1/2" AIR RATCHET



ITEM	MN612A
USE	
SQUARE DRIVE	1/2"
AIR CONSUMPTION	3 CFM
WORKING PRESSURE	90 psi
AIR INLET	1/4" NPT
NO-LOAD SPEED	150 r/min
MAX TORQUE	65 ft-lb (88 Nm)
WEIGHT	2.4 lb (1.1 kg)
AVAILABILITY	1 AVAILABLE On Request

- Compact and lightweight design for work in confined spaces.
- Easy to maneuver when changing directions.
- Ideal for installing or removing spark plugs, radiators, water pumps, exhaust systems, and more.



## PNEUMATIC MOTOTOOLS

### MINI AIR DIE GRINDER AND ACCESSORIES SET

**15** PIECES



- Compact and powerful design for precision grinding, polishing, and deburring.
  - High-speed performance for efficient material removal.
  - Ergonomic housing ensures comfort and control during extended use.
- Improved product will be supplied according to inventory rotation.*

ITEM	PIECES	AVAILABLE
UJMT87	15	1 <span>On Request</span>

**7** PIECES



- Durable plastic case for easy transport and reliable product protection.

ITEM	PIECES	AVAILABLE
UP860K	7	1 ✓

### STRAIGHT PNEUMATIC DIE GRINDERS

**103** DB



UMT81

**103** DB



UMT82

**103** DB



UMT83

- Comfortable design for extended use in long-duration tasks
- Lever lock for added safety and control.
- Jacobs® chuck for secure mounting of polishing accessories.

- Comfortable design for extended use in long-duration tasks.
- Lever lock for added safety and reliable control.

- Comfortable design for extended use during long working hours.
- Lever lock for enhanced safety and precise control.

ITEM	UMT81	UMT82	UMT83
USE			
COUPLING TYPE	Collet 3/8"	Collet 1/4"	Collet 1/4"
NO-LOAD SPEED	20,000 rpm	22,000 rpm	25,000 rpm
AIR CONSUMPTION	7 SCFM	7 SCFM	4 SCFM
WORKING PRESSURE	90 psi	90 psi	90 psi
AIR INLET	1/4" NPT	1/4" NPT	1/4" NPT
AVAILABLE	1 <span>On Request</span>	1 <span>On Request</span>	1 <span>On Request</span>

### PNEUMATIC ANGLE DIE GRINDER

**103** DB



ITEM	UMT84
USE	
COUPLING TYPE	Collet 1/4"
NO-LOAD SPEED	20,000 rpm
AIR CONSUMPTION	4 SCFM
WORKING PRESSURE	90 psi
AIR INLET	1/4" NPT
AVAILABLE	1 <span>On Request</span>

- Comfortable design for extended use in long-duration tasks.
- Lever lock for added safety and control.
- 90° angled head provides greater flexibility in confined spaces.

### PNEUMATIC ANGLE DIE GRINDER



ITEM	MTA414
USE	
COUPLING TYPE	1/4" (6, 35 mm)
NO-LOAD SPEED	20,000 rpm
AIR CONSUMPTION	4, 3 CFM
WORKING PRESSURE	90 psi
AIR INLET	1/4" NPT
AVAILABLE	1 <span>On Request</span>

3/8" DRIVE AIR IMPACT WRENCHES

3/8" COMPOSITE IMPACT WRENCH TWIN JUMBO SYSTEM



ITEM	UPX727
USE	
SQUARE DRIVE	3/8"
BREAKAWAY TORQUE	400 ft-lb
RATED TORQUE	500 ft-lb
AIR CONSUMPTION	5 CFM
WEIGHT	2.6 lb (1.2 kg)
	1
AVAILABLE	✓



- One-hand operation button for easy and convenient control.
- Lightweight design for greater comfort and maneuverability.



3/8" SQUARE DRIVE COMPOSITE PNEUMATIC IMPACT WRENCH



NEW

ITEM	PC727A
USE	
SQUARE DRIVE	3/8"
AIR CONSUMPTION	13.1 CFM
WORKING PRESSURE	90 PSI
AIR INLET	1/4" NPT
FREE SPEED	9,000 rpm
MAXIMUM TORQUE	350 ft-lb (470 Nm)
WEIGHT	3.3 lb (1.5 kg)
	1
AVAILABLE	On Request



- Twin Hammer mechanism with two identical hammers delivers an instant, balanced and more powerful blow, reducing vibration and ensuring maximum impact.
- Rubberized anti-slip grip for safer, more comfortable handling.
- Lightweight composite housing lowers overall weight and minimizes vibration for improved operator comfort



3/8" COMPOSITE IMPACT WRENCH TWIN HAMMER SYSTEM



ITEM	UPC727
USE	
SQUARE DRIVE	3/8"
TORQUE	280 ft-lb
AIR CONSUMPTION	2.5 SCFM
WEIGHT	1.2 lb (2.6 kg)
	1
AVAILABLE	✓



- The handle's exhaust directs air away from the object and user.
- Soft inclined handle provide comfortable grip.



1/2" DRIVE AIR IMPACT WRENCHES

1/2" COMPOSITE IMPACT WRENCH TWIN HAMMER SYSTEM AND INCH SOCKET SET

**13 PIECES**

Content

Item	Size
7412H	3/8"
7414H	7/16"
7416H	1/2"
7418H	9/16"
7420H	5/8"
7422H	11/16"
7424H	3/4"
7426H	13/16"
7428H	7/8"
7430H	15/16"

Accessories

- UPC731 1/2" impact wrench
- 7181P 1/2 x 5" extension
- CPUC20 21" compact box



ITEM	PIECES		AVAILABLE
UPC731K	13	1	✓

1/2" COMPOSITE IMPACT WRENCH TWIN HAMMER SYSTEM AND METRIC SOCKET SET

**13 PIECES**

Content

Item	Size
7410M	10 mm
7412M	12 mm
7413M	13 mm
7414M	14 mm
7415M	15 mm
7416M	16 mm
7417M	17 mm
7418M	18 mm
7419M	19 mm
7421M	21 mm

Accessories

- UPC731 1/2" impact wrench
- 7181P 1/2 x 5" extension
- CPUC20 21" compact box



ITEM	PIECES		AVAILABLE
UPC731KM	13	1	✓

## 1/2" DRIVE AIR IMPACT WRENCHES

### 1/2" COMPOSITE IMPACT WRENCH TWIN HAMMER SYSTEM

MEGA DUTY **1/2" DRIVE** TH **TWIN HAMMER** REVERSIBLE FUNCTION ((dB)) **92.7** DB



ITEM	UPX731A
USE	
BREAKAWAY TORQUE	600 ft-lb
RATED TORQUE	1,000 ft-lb
AIR CONSUMPTION	4.8 CFM
WEIGHT	4.2 lb (2 kg)
	1
AVAILABLE	✓



- One-hand operation button for easy and convenient control.
- Lightweight design for greater comfort and maneuverability.

### 1/2" COMPOSITE IMPACT WRENCH TWIN HAMMER SYSTEM

MEGA DUTY **1/2" DRIVE** TH **TWIN HAMMER** REVERSIBLE FUNCTION ((dB)) **92.7** DB



ITEM	UPX731
USE	
BREAKAWAY TORQUE	800 ft-lb
RATED TORQUE	1,000 ft-lb
AIR CONSUMPTION	4.8 CFM
WEIGHT	4.1 lb (2 kg)
	1
AVAILABLE	✓



- One-hand operation button for greater convenience and control.
- Lightweight design for improved comfort and maneuverability.

### 1/2" STUBBY COMPOSITE IMPACT WRENCH JUMBO HAMMER SYSTEM

MEGA DUTY **1/2" DRIVE** JH **JUMBO HAMMER** REVERSIBLE FUNCTION ((dB)) **94.4** DB



ITEM	UPX731B
USE	
BREAKAWAY TORQUE	450 ft-lb
RATED TORQUE	500 ft-lb
AIR CONSUMPTION	4.3 CFM
WEIGHT	2.4 lb (1.1 kg)
	1
AVAILABLE	✓



- One-hand reversible action for quick and easy direction changes.
- Compact and powerful design for maximum performance in tight spaces.

### 1/2" SQUARE DRIVE COMPOSITE PNEUMATIC IMPACT WRENCH

HEAVY DUTY **1/2" DRIVE** TH **TWIN HAMMER** REVERSIBLE FUNCTION ((dB)) **92** DB



ITEM	PC731A
USE	
SQUARE DRIVE	1/2"
AIR CONSUMPTION	16.9 CFM
WORKING PRESSURE	90 PSI
AIR INLET	1/4" NPT
FREE SPEED	8,500 rpm
MAXIMUM TORQUE	590 ft-lb (800 Nm)
WEIGHT	4.3 lb (2.25 kg)
	1
AVAILABLE	On Request



NEW



- Twin Hammer mechanism with two identical hammers delivers an instant, balanced and more powerful blow, reducing vibration and ensuring maximum impact.
- Rubber anti-slip grip for safer and more comfortable handling.
- Lightweight composite housing reduces weight and minimizes vibration for improved operator comfort.

1/2" DRIVE AIR IMPACT WRENCHES

1/2" IMPACT WRENCH WITH TWIN HAMMER SYSTEM

**1/2" DRIVE** **TH** TWIN HAMMER **REVERSIBLE FUNCTION** ((dB) **80** DB

URREA



ITEM	UP731
USE	
SQUARE DRIVE	1/2"
TORQUE	400 ft-lb
AIR CONSUMPTION	4 SCFM
WEIGHT	5.5 lb (2.5 kg)
	1
AVAILABLE	✓

- Twin Hammer mechanism prolongs the tool's life, even if heavily used.
- Variable speed trigger and double regulator for a better control.

3/4" SQUARE DRIVE COMPOSITE PNEUMATIC IMPACT WRENCHES

3/4" IMPACT WRENCH TWIN HAMMER SYSTEM AND INCH SOCKET SET

URREA

**3/4" DRIVE** **INCHES** **3/4"** **6**



**3/4" DRIVE**

**10** PIECES



Content	
Item	Size
7512	3/4"
7513	13/16"
7515	15/16"
7516	1"
7517	1-1/16"
7518	1-1/8"
7519	1-3/16"
7520	1-1/4"

Content	
Accessories	
UP776	3/4" impact wrench
CPUC20	21" compact box



ITEM	PIECES		AVAILABLE
UP776K	10	1	✓

3/4" IMPACT WRENCH TWIN HAMMER SYSTEM AND METRIC SOCKET SET

URREA

**3/4" DRIVE** **METRIC** **3/4"** **6**



**3/4" DRIVE**

**10** PIECES



Content	
Item	Size
7519M	19 mm
7521M	21 mm
7524M	24 mm
7525M	25 mm
7527M	27 mm
7529M	29 mm
7530M	30 mm
7532M	32 mm

Content	
Accessories	
UP776	3/4" impact wrench
CPUC20	21" compact box



ITEM	PIECES		AVAILABLE
UP776KM	10	1	✓

3/4" COMPOSITE IMPACT WRENCH TWIN HAMMER SYSTEM

**3/4" DRIVE** **TH** TWIN HAMMER **REVERSIBLE FUNCTION** ((dB) **93.8** DB

URREA



ITEM	UPX776
USE	
BREAKAWAY TORQUE	1200 ft-lb
RATED TORQUE	1,400 ft-lb
AIR CONSUMPTION	7.5 CFM
WEIGHT	7.4 lb (3.4 kg)
	1
AVAILABLE	✓

- One-hand operation button for quick and easy control
- Lightweight design for greater comfort and maneuverability

## 3/4" DRIVE AIR IMPACT WRENCHES

### 3/4" SQUARE DRIVE COMPOSITE PNEUMATIC IMPACT WRENCH

HEAVY DUTY **3/4" DRIVE** **TH** TWIN HAMMER **REVERSIBLE FUNCTION** ((dB)) **102** DB



ITEM	PC776A
USE	
SQUARE DRIVE	3/4"
AIR CONSUMPTION	25.4 CFM
WORKING PRESSURE	90 PSI
AIR INLET	3/8" NPT
FREE SPEED	6,000 rpm
MAXIMUM TORQUE	885 ft-lb (1,200 Nm)
WEIGHT	9.4 lb (4.3 kg)
	1
AVAILABLE	On Request



- Twin Hammer mechanism with two identical hammers delivers an instant, balanced and more powerful blow, reducing vibration and ensuring maximum impact.
- Rubberized anti-slip grip for safer, more comfortable handling.
- Lightweight composite housing reduces overall weight and minimizes vibration for greater operator comfort.



## 1" SQUARE DRIVE COMPOSITE PNEUMATIC IMPACT WRENCHES

### 1" COMPOSITE IMPACT WRENCH TWIN HAMMER SYSTEM

MEGA DUTY **1" DRIVE** **TH** TWIN HAMMER **REVERSIBLE FUNCTION** ((dB)) **93.8** DB



ITEM	UPX893
USE	
BREAKAWAY TORQUE	1200 ft-lb
RATED TORQUE	1,400 ft-lb
AIR CONSUMPTION	7.5 CFM
WEIGHT	7.4 lb (3.4 kg)
	1
AVAILABLE	✓



- One-hand operation button for greater convenience.
- Lightweight design for improved comfort and maneuverability.



### COMPOSITE SISTEMA TWIN HAMMER

SUPER DUTY **1" DRIVE** **TH** TWIN HAMMER **REVERSIBLE FUNCTION** ((dB)) **95** DB



ITEM	P893B
USE	
SQUARE DRIVE	1"
AIR CONSUMPTION	28.1 CFM
WORKING PRESSURE	90 PSI
AIR INLET	1/2" NPT
FREE SPEED	4,500 rpm
MAXIMUM TORQUE	1,035 ft-lb (1,400 Nm)
WEIGHT	14.7 lb (6.7 kg)
	1
AVAILABLE	On Request



- Auxiliary handle for easier handling



- Twin Hammer mechanism with two identical hammers delivers an instant, balanced and more powerful blow, reducing vibration and ensuring maximum impact.
- 3-position power regulator with forward/reverse control for precise adjustment and versatile operation.



# SUPERIOR Speed

usa.urrea.com

3/4" SQUARE DRIVE PNEUMATIC IMPACT WRENCH

**3/8" SQUARE DRIVE PNEUMATIC IMPACT WRENCHES**

**3/8" SQUARE DRIVE PNEUMATIC IMPACT WRENCH**



URREA



NEW

ITEM	P727
USE	
SQUARE DRIVE	3/8"
AIR CONSUMPTION	13.3 CFM
WORKING PRESSURE	90 PSI
AIR INLET	1/4" NPT
FREE SPEED	9,300 rpm
MAXIMUM TORQUE	385 ft-lb (520 Nm)
WEIGHT	3.5 lb (1.62 kg)
	1
AVAILABLE	On Request



- Single Hammer mechanism delivers one powerful blow per rotation for strong and consistent impact.
- Compact and powerful design for maximum performance in demanding applications



**3/8" IMPACT WRENCH WITH ROCKING DOG SYSTEM**



URREA



• Oil-lubricated impact mechanism for longer life and increased durability



• 360° rotating air inlet for easier maneuverability

ITEM	UP722
USE	
SQUARE DRIVE	3/8"
TORQUE	75 ft-lb
AIR CONSUMPTION	3 SCFM
WEIGHT	4.6 lb (2.1 kg)
	1
AVAILABLE	✓



- Rocking Dog mechanism delivers one blow per rotation on a single anvil side, ensuring high power transfer. Tools with this mechanism are especially recommended for assembly and disassembly tasks.
- Butterfly valve allows easy one-handed forward/reverse operation



**1/2" SQUARE DRIVE PNEUMATIC IMPACT WRENCHES**

**1/2" IMPACT WRENCH TWIN HAMMER SYSTEM AND INCH SOCKET SET**



URREA



13 PIECES

Content	Item	Size
	7412H	3/8"
	7414H	7/16"
	7416H	1/2"
	7418H	9/16"
	7420H	5/8"
	7422H	11/16"
	7424H	3/4"
	7426H	13/16"
	7428H	7/8"
	7430H	15/16"



Content	Accessories
7181P	5" extension
UP731	1/2" impact wrench
CPUC20	21" compact box

ITEM	PIECES	AVAILABLE
UP731K	13	On Request

**1/2" IMPACT WRENCH TWIN HAMMER SYSTEM AND METRIC SOCKET SET**



URREA



13 PIECES

Content	Item	Size
	7410M	10 mm
	7412M	12 mm
	7413M	13 mm
	7414M	14 mm
	7415M	15 mm
	7416M	16 mm
	7417M	17 mm
	7418M	18 mm
	7419M	19 mm
	7421M	21 mm



Content	Accessories
7181P	5" extension
UP731	1/2" impact wrench
CPUC20	21" compact box

ITEM	PIECES	AVAILABLE
UP731KM	13	✓

**1/2" IMPACT WRENCH PIN CLUTCH SYSTEM AND INCH SOCKET SET**



URREA



13 PIECES

Content	Item	Size
	7412H	3/8"
	7414H	7/16"
	7416H	1/2"
	7418H	9/16"
	7420H	5/8"
	7422H	11/16"
	7424H	3/4"
	7426H	13/16"
	7428H	7/8"
	7430H	15/16"



Content	Accessories
7181P	5" extension
UP734H	1/2" impact wrench
CPUC20	21" compact box

ITEM	PIECES	AVAILABLE
UP734HK	13	✓

**1/2" IMPACT WRENCH PIN CLUTCH SYSTEM AND METRIC SOCKET SET**



URREA



13 PIECES

Content	Item	Size
	7410M	10 mm
	7412M	12 mm
	7413M	13 mm
	7414M	14 mm
	7415M	15 mm
	7416M	16 mm
	7417M	17 mm
	7418M	18 mm
	7419M	19 mm
	7421M	21 mm



Content	Accessories
7181P	5" extension
UP734H	1/2" impact wrench
CPUC20	21" compact box

ITEM	PIECES	AVAILABLE
UP734HKM	13	✓

## 1/2" SQUARE DRIVE PNEUMATIC IMPACT WRENCHES

### 1/2" IMPACT WRENCH TWIN HAMMER SYSTEM AND INCH SOCKET SET



**1/2"**  
DRIVE

**7**  
PIECES



Content	
Item	Size
7416H	1/2"
7420H	5/8"
7424H	3/4"
7428H	7/8"
7430H	15/16"

Content	
Accessories	
UP731A	1/2" Impact wrench
CPUC20	21" compact box



ITEM	PIECES	📦	AVAILABLE
UP731AK	7	1	✓

### 1/2" IMPACT WRENCH TWIN HAMMER SYSTEM AND METRIC SOCKET SET



**1/2"**  
DRIVE

**7**  
PIECES



Content	
Item	Size
7414M	14 mm
7416M	16 mm
7417M	17 mm
7419M	19 mm
7422M	22 mm

Content	
Accessories	
UP731A	1/2" Impact wrench
CPUC20	21" compact box



ITEM	PIECES	📦	AVAILABLE
UP731AKM	7	1	✓

### 1/2" SQUARE DRIVE PNEUMATIC IMPACT WRENCH



**NEW**



ITEM	P734HA
USE	
SQUARE DRIVE	1/2"
AIR CONSUMPTION	15.9 CFM
WORKING PRESSURE	90 PSI
AIR INLET	1/4" NPT
FREE SPEED	8,500 rpm
MAXIMUM TORQUE	490 ft-lb (660 Nm)
WEIGHT	5.7 lb (2.6 kg)
📦	1
AVAILABLE	On Request

- Twin Hammer mechanism features two identical hammers that deliver an instant, balanced and more powerful blow, reducing vibration and ensuring maximum impact.
- Front air exhaust directs airflow away from the operator for improved safety and comfort.
- 5-position power regulator for precise control and versatility in different applications.



### 1/2" SQUARE DRIVE PNEUMATIC IMPACT WRENCH



**NEW**



ITEM	P731C
USE	
SQUARE DRIVE	1/2"
AIR CONSUMPTION	13.3 CFM
WORKING PRESSURE	90 PSI
AIR INLET	1/4" NPT
FREE SPEED	9,300 rpm
MAXIMUM TORQUE	385 ft-lb (520 Nm)
WEIGHT	3.6 lb (1.64 kg)
📦	1
AVAILABLE	On Request

- Single Hammer mechanism delivers one powerful blow per rotation, ensuring strong and consistent impact.
- Compact and powerful design for high performance in tight spaces





1/2" SQUARE DRIVE PNEUMATIC IMPACT WRENCHES

1/2" SQUARE DRIVE PNEUMATIC IMPACT WRENCH



ITEM	P731B
USE	HEAVY DUTY
SQUARE DRIVE	1/2"
AIR CONSUMPTION	16.9 CFM
WORKING PRESSURE	90 PSI
AIR INLET	1/4" NPT
FREE SPEED	8,000 rpm
MAXIMUM TORQUE	627 ft-lb (850 Nm)
WEIGHT	6.8 lb (3.1 kg)
	1
AVAILABLE	On Request

- Twin Hammer mechanism features two identical hammers that deliver an instant, balanced and more powerful blow, reducing vibration and ensuring maximum impact.
- Front air exhaust directs airflow away from the operator for greater safety and comfort

PNEUMATIC IMPACT WRENCH



ITEM	PI612
USE	PROFESSIONAL USE
SQUARE DRIVE	1/2"
AIR CONSUMPTION	7 CFM
WORKING PRESSURE	90 psi
AIR INLET	1/4" NPT
FREE SPEED	7,000 rpm
MAXIMUM TORQUE	360 ft-lb (488 Nm)
WEIGHT	5.7 lb (2.6 kg)
	1
AVAILABLE	✓

- Twin Hammer mechanism delivers an instant, balanced and more powerful blow, reducing vibration and providing higher torque



PNEUMATIC IMPACT WRENCH



ITEM	PI412A
USE	GENERAL USE
SQUARE DRIVE	1/2"
AIR CONSUMPTION	4 CFM
WORKING PRESSURE	90 psi
AIR INLET	1/4" NPT
FREE SPEED	7,000 rpm
MAXIMUM TORQUE	207 ft-lb (488 Nm)
WEIGHT	4.4 lb (2.1 kg)
	1
AVAILABLE	✓



PNEUMATIC TOOLS

## 3/4" DRIVE AIR IMPACT WRENCHES

### 3/4" COMPOSITE IMPACT WRENCH TWIN HAMMER SYSTEM AND SAE SOCKET SET



**SUPER DUTY** INCHES **3/4"** **6**



**3/4"**  
DRIVE

**10**  
PIECES



Content	
Item	Size
7512	3/4"
7513	13/16"
7515	15/16"
7516	1"
7517	1-1/16"
Accessories	
UPC776	3/4" impact wrench
CPUC20	21" compact box
7519	1-3/16"
7520	1-1/4"

Content	
Item	Size
7517	1-1/16"
7518	1-1/8"
7519	1-3/16"
7520	1-1/4"



ITEM	PIECES	AVAILABLE
UPC776K	10	1 <input checked="" type="checkbox"/> AVAILABLE

### 3/4" COMPOSITE IMPACT WRENCH TWIN HAMMER SYSTEM AND METRIC SOCKET SET



**SUPER DUTY** METRIC **3/4"** **6**



**3/4"**  
DRIVE

**10**  
PIECES



Content	
Item	Size
7519M	19 mm
7521M	21 mm
7524M	24 mm
7525M	25 mm
7527M	27 mm
Accessories	
UPC776	3/4" impact wrench
CPUC20	21" compact box
7530M	30 mm
7532M	32 mm

Content	
Item	Size
7527M	27 mm
7529M	29 mm
7530M	30 mm
7532M	32 mm



ITEM	PIECES	AVAILABLE
UPC776KM	10	1 <input checked="" type="checkbox"/> AVAILABLE

### 3/4" IMPACT WRENCH TWIN HAMMER SYSTEM AND SAE SOCKET SET



**HEAVY DUTY** INCHES **3/4"** **6**



**3/4"**  
DRIVE

**10**  
PIECES



Content	
Item	Size
7512	3/4"
7513	13/16"
7515	15/16"
7516	1"
7517	1-1/16"
Accessories	
UP772H	3/4" impact wrench
CPUC20	21" compact box
7519	1-3/16"
7520	1-1/4"

Content	
Item	Size
7517	1-1/16"
7518	1-1/8"
7519	1-3/16"
7520	1-1/4"



ITEM	PIECES	AVAILABLE
UP772HK	10	1 <input checked="" type="checkbox"/> AVAILABLE

### 3/4" IMPACT WRENCH TWIN HAMMER SYSTEM AND METRIC SOCKET SET



**HEAVY DUTY** METRIC **3/4"** **6**



**3/4"**  
DRIVE

**10**  
PIECES



Content	
Item	Size
7519M	19 mm
7521M	21 mm
7524M	24 mm
7525M	25 mm
7527M	27 mm
Accessories	
UP772H	3/4" impact wrench
CPUC20	21" compact box
7530M	30 mm
7532M	32 mm

Content	
Item	Size
7527M	27 mm
7529M	29 mm
7530M	30 mm
7532M	32 mm



ITEM	PIECES	AVAILABLE
UP772HKM	10	1 <input checked="" type="checkbox"/> AVAILABLE

### 3/4" IMPACT WRENCH TWIN HAMMER SYSTEM AND SAE SOCKET SET



**HEAVY DUTY** INCHES **3/4"** **6**



**3/4"**  
DRIVE

**7**  
PIECES



Content	
Item	Size
7514	7/8"
7515	15/16"
7516	1"
7517	1-1/16"
7518	1-1/8"

Content	
Item	Size
7516	1"
7517	1-1/16"
7518	1-1/8"



ITEM	PIECES	AVAILABLE
UP772HAK	7	1 <input type="checkbox"/> On Request

### 3/4" IMPACT WRENCH TWIN HAMMER SYSTEM AND METRIC SOCKET SET



**HEAVY DUTY** METRIC **3/4"** **6**



**3/4"**  
DRIVE

**7**  
PIECES



Content	
Item	Size
7524M	24 mm
7527M	27 mm
7530M	30 mm
7532M	32 mm
7536M	36 mm

Content	
Item	Size
7524M	24 mm
7527M	27 mm
7530M	30 mm
7532M	32 mm
7536M	36 mm



ITEM	PIECES	AVAILABLE
UP772HAKM	7	1 <input checked="" type="checkbox"/> AVAILABLE

3/4" DRIVE AIR IMPACT WRENCHES

3/4" SQUARE DRIVE PNEUMATIC IMPACT WRENCH

HEAVY DUTY **3/4" DRIVE** **TH** TWIN HAMMER **REVERSIBLE FUNCTION** ((dB)) **93** DB

ITEM	P772HB
USE	
SQUARE DRIVE	3/4"
AIR CONSUMPTION	28.1 CFM
WORKING PRESSURE	90 PSI
AIR INLET	3/8" NPT
FREE SPEED	6,000 rpm
MAXIMUM TORQUE	885 ft-lb (1,200 Nm)
WEIGHT	11 lb (5 kg)
	1
AVAILABLE	On Request

• Twin Hammer mechanism uses two identical hammers to deliver a balanced, instant and powerful blow, reducing vibration and providing maximum impact



3/4" SQUARE DRIVE PNEUMATIC IMPACT WRENCH

HEAVY DUTY **3/4" DRIVE** **TH** TWIN HAMMER **REVERSIBLE FUNCTION** ((dB)) **95** DB

ITEM	P776A
USE	
SQUARE DRIVE	3/4"
AIR CONSUMPTION	28.1 CFM
WORKING PRESSURE	90 PSI
AIR INLET	1/2" NPT
FREE SPEED	4,500 rpm
MAXIMUM TORQUE	1,035 ft-lb (1,400 Nm)
WEIGHT	14.7 lb (6.7 kg)
	1
AVAILABLE	On Request

• Twin Hammer mechanism features two identical hammers that deliver an instant, balanced and more powerful blow, reducing vibration and ensuring maximum impact



1" DRIVE AIR IMPACT WRENCHES

1" SQUARE DRIVE PNEUMATIC IMPACT WRENCH SINGLE HAMMER SYSTEM

SUPER DUTY **1" DRIVE** **SH** SINGLE HAMMER **REVERSIBLE FUNCTION**

ITEM	P1098-9
USE	
SQUARE DRIVE	1"
AIR CONSUMPTION	46.6 CFM
WORKING PRESSURE	90 PSI
AIR INLET	1/2" NPT
FREE SPEED	2,800 rpm
MAXIMUM TORQUE	4,794 ft-lb (6,500 Nm)
WEIGHT	47.4 lb (21.5 kg)
	1
AVAILABLE	On Request

- 9" (229 mm) spindle length
- Auxiliary handle for easier handling

• Single Hammer mechanism delivers one powerful blow per rotation, ensuring maximum impact performance  
• 3-position power regulator with forward/reverse control for versatile operation



1" SQUARE DRIVE PNEUMATIC IMPACT WRENCH

SUPER DUTY **1" DRIVE** **TH** TWIN HAMMER **REVERSIBLE FUNCTION**

ITEM	P797-9
USE	
SQUARE DRIVE	1"
AIR CONSUMPTION	29.8 CFM
WORKING PRESSURE	90 PSI
AIR INLET	1/2" NPT
FREE SPEED	3,500 rpm
MAXIMUM TORQUE	1,548 ft-lb (2,100 Nm)
WEIGHT	31.0 lb (14.1 kg)
	1
AVAILABLE	On Request

- 9" (229 mm) spindle length
- Auxiliary handle for easier operation

• Twin Hammer mechanism with dual identical hammers delivers a balanced, instant and powerful blow, reducing vibration for maximum performance  
• 3-position power regulator with forward/reverse control for precise operation



PNEUMATIC TOOLS

## 1" DRIVE AIR IMPACT WRENCHES

### 1" SQUARE DRIVE PNEUMATIC IMPACT WRENCH



URREA



NEW

ITEM	P898-9
USE	
SQUARE DRIVE	1"
AIR CONSUMPTION	32.8 CFM
WORKING PRESSURE	90 PSI
AIR INLET	1/2" NPT
FREE SPEED	3,200 rpm
MAXIMUM TORQUE	1,918 ft-lb (2,600 Nm)
WEIGHT	33.5 lb (15.2 kg)
	1
AVAILABLE	On Request



• 9" (229 mm) spindle length



• Auxiliary handle for easier operation



- Twin Hammer mechanism with dual identical hammers delivers an instant, balanced and powerful blow, reducing vibration for maximum performance
- 3-position power regulator with forward/reverse control for precise operation.



### 1" SQUARE DRIVE COMPOSITE PNEUMATIC IMPACT WRENCH



URREA



NEW

ITEM	PC798
USE	
SQUARE DRIVE	1"
AIR CONSUMPTION	26.6 CFM
WORKING PRESSURE	90 PSI
AIR INLET	3/8" NPT
FREE SPEED	4,200 rpm
MAXIMUM TORQUE	1,035 ft-lb (1,400 Nm)
WEIGHT	12.5 lb (5.7 kg)
	1
AVAILABLE	On Request



- Twin Hammer mechanism with dual identical hammers delivers a balanced, instant and powerful blow, reducing vibration and ensuring maximum impact
- Rubber anti-slip grip for safer, more comfortable handling
- Lightweight composite housing reduces overall weight and minimizes vibration



### 1" IMPACT WRENCH ROCKING DOG SYSTEM 6" EXTENDED ANVIL



URREA



ITEM	UP898-6B
USE	
SQUARE DRIVE	1"
TORQUE	2,582.3 ft-lb
AIR CONSUMPTION	12 SCFM
WEIGHT	27 lb (11.9 kg)
	1
AVAILABLE	On Request



- Rocking Dog mechanism features a durable rotating hammer design
- Provides high load capacity and exceptional durability
- Ideal for assembly and disassembly applications



## 1-1/2" DRIVE AIR IMPACT WRENCH

### 1-1/2" SQUARE DRIVE PNEUMATIC IMPACT WRENCH



URREA



NEW

ITEM	P6120A
USE	
SQUARE DRIVE	1.5"
AIR CONSUMPTION	50.8 CFM
WORKING PRESSURE	90 PSI
AIR INLET	1/2" NPT
FREE SPEED	2,800 rpm
MAXIMUM TORQUE	4,794 ft-lb (6,500 Nm)
WEIGHT	47.8 lb (21.7 kg)
	1
AVAILABLE	On Request



• 9" (229 mm) spindle length



• Auxiliary handle for easier handling



- Single Hammer mechanism delivers one powerful blow per rotation for maximum impact
- 3-position power regulator with forward/reverse control for precise operation.



**PAINT SPRAY GUNS**

**GRAVITY FEED SPRAY GUNS AND REPLACEMENTS**

**1.3 mm NOZZLE**

**LVMP**  
LOW VOLUMEN  
MEDIUM PRESSURE

**1.7 mm NOZZLE**

**HVLP**  
HIGH VOLUMEN  
LOW PRESSURE

**1.0 mm NOZZLE**

**HVLP**  
HIGH VOLUMEN  
LOW PRESSURE



Use in industry

**PPG13**  
Gravity LVMP

- Non-continuous air flow.
- Material, air, and fan control.
- External mixing.
- Gravity feed LVMP.
- Higher efficiency and material savings.
- 600 ml (20.29 oz) plastic cup.

- Aluminium body



Use in industry

**PPG17**  
Gravity LVMP

- Non-continuous air flow.
- Material, air, and fan control.
- External mixing.
- Gravity feed LVMP.
- Higher efficiency and material savings.
- 600 ml (20.29 oz) plastic cup.



Use in industry

**PPG10**  
Mini gravity spray gun.

- Non-continuous air flow.
- Material, air, and fan control.
- External mixing.
- Gravity feed HVLP.
- Higher efficiency and material savings.
- 600 ml (20.29 oz) plastic cup.
- Aluminum body.



**RPPG13**



**RPPG17**



**RPPG10**



**VAS600**  
600 ml (20.29 oz)



**VAS100**  
100 ml (3.38 oz)



ITEM	PPG13	PPG17	PPG10
USE			
CUP CAPACITY	20.29 oz (600 ml)	20.29 oz (600 ml)	3.38 oz (100 ml)
WORKING PRESSURE	36 psi	29 psi	22 psi
AIR CONSUMPTION	10.6 CFM	14 CFM	7 CFM
AIR INLET	1/4" NPT	1/4" NPT	1/4" NPT
NOZZLE DIAMETER	1.3 mm	1.7 mm	1.0 mm
CUP	Plastic	Plastic	Plastic
AVAILABLE	On Request	On Request	On Request
<b>ACCESSORIES</b>			
MINI AIR REGULATOR	1	1	-
CLEANING BRUSH	1	1	1
HOSE CONNECTOR	1	1	1
FILTERS	3	3	1

**Spare parts**

ITEM	FOR ITEM	AVAILABLE
RPPG13	PPG13	On Request
RPPG17	PPG17	On Request
RPPG10	PPG10	On Request
VAS100	PPG10	On Request
VAS600	PPG13 y PPG17	On Request



usa.urrea.com

## PAINT SPRAY GUNS

### GRAVITY FEED SPRAY GUN

**PROFESSIONAL USE** **50 PSI** WORK PRESSURE  
**HVLP** HIGH VOLUMEN LOW PRESSURE



**PPG1**  
HVLV gravity type.

- Non-continuous airflow.
- Material, air, and fan control.
- External mix.
- Gravity feed.
- Higher efficiency and material savings.
- 600 ml plastic cup.



**PROFESSIONAL USE** **50 PSI** WORK PRESSURE  
**HVLP** HIGH VOLUMEN LOW PRESSURE



**PPG2**  
HVLV gravity type.

- Non-continuous airflow.
- Material, air, and fan control.
- External mix.
- Can be used closer to the surface.
- Gravity feed.
- 125 ml plastic cup.



**PROFESSIONAL USE** **72 PSI** WORK PRESSURE  
**HVLP** HIGH VOLUMEN LOW PRESSURE



Rotating cup.

**PPG3**  
HVLV gravity type.

- Non-continuous airflow.
- Material, air, and fan control.
- External mix.
- Gravity feed.
- 400 ml rotating cup that facilitates painting in any position.



PNEUMATIC TOOLS

ITEM	PPG1	PPG2	PPG3
USE			
CUP CAPACITY	20.23 oz (600 ml)	4.23 oz (125 ml)	13.53 oz (400 ml)
WORKING PRESSURE	50 psi	50 psi	72 psi
AIR CONSUMPTION	6 CFM	4 CFM	8 CFM
AIR INLET	1/4" NPT	1/4" NPT	1/4" NPT
NOZZLE DIAMETER	1.4 mm (1/16")	0.8 mm (1/32")	1.5 mm
CUP	Plastic	Plastic	Aluminium
	1	1	1
AVAILABLE	On Request	On Request	On Request

#### SPARE PARTS

ITEM	FOR ITEM		AVAILABLE
RPPG1	PPG1	1	On Request
RPPG2	PPG2	1	On Request
RPPG3	PPG3	1	On Request

### MINI GRAVITY FEED SPRAY GUN

**PROFESSIONAL USE** **72 PSI** WORK PRESSURE



**PPG4**

- With adjustable nozzle tip.
- Internal mix.
- Gravity feed.
- Non-continuous air flow.
- Material and fan control.
- 125 ml swivel aluminum cup for easy painting in any position.



**RPPG4**

ITEM	PPG4
USE	
CUP CAPACITY	4.23 oz (125 ml)
WORKING PRESSURE	72 psi
AIR CONSUMPTION	4 CFM
AIR INLET	1/4" NPT
NOZZLE DIAMETER	0.5 mm (1/64")
CUP	Aluminium
	1
AVAILABLE	On Request

#### Replacement cup

ITEM	FOR ITEM		AVAILABLE
RPPG4	PPG4	1	On Request

### PAINT APPLICATION EQUIPMENT

**MASTER USE** **72 PSI** WORK PRESSURE



ITEM	FOR ITEM		AVAILABLE
REPP10	EPP10	1	On Request

PAINT SPRAY GUNS

PAINT SPRAY GUNS WITH REINFORCED CUP

**PROFESSIONAL USE**  
**72 PSI**  
 WORK PRESSURE



**PPA1**  
Suction Type

- For uniform painting.
- External mix.
- Suction feed.
- Non-continuous air flow.
- Material and fan control.
- Reinforced cup.



**PROFESSIONAL USE**  
**45 PSI**  
 WORK PRESSURE



**PPB1**  
Suction Type

- Internal mixing
- Suction feed
- Continuous airflow
- Material and fan pattern control
- Reinforced large-capacity cup (1000 ml)



**PROFESSIONAL USE**  
**50 PSI**  
 WORK PRESSURE



**PPB2**  
Suction Type

- Internal mixing
- Suction feed
- Continuous airflow
- Material and fan pattern control



**RPB1**  
**RPB2**



**VPB1**

ITEM	PPA1	PPB1	PPB2
USE			
CUP CAPACITY	33.81 oz (1000 ml)	33.81 oz (1000 ml)	33.81 oz (1000 ml)
WORKING PRESSURE	72 psi	50 psi	50 psi
AIR CONSUMPTION	9 CFM	6 CFM	6 CFM
AIR INLET	1/4" NPT	1/4" NPT	1/4" NPT
	1	1	1
AVAILABLE	On Request	On Request	On Request

SPARE PARTS

ITEM	FOR ITEM		AVAILABLE
REPP10	PPA1	1	On Request
RPB1	PPB1	1	On Request
VPB1	PPB1	1	On Request
RPB2	PPB2	1	On Request

AIRBRUSH SET

**PROFESSIONAL USE**  
**35 PSI**  
 WORK PRESSURE

**7**  
PIECES



Content	
Airbrush	1
Mixer jar with lid	1
Color-changing jar	1
Air compressor adapter	1
Hose	1
Propellant air can adapter	1
Dropper	1

- Suggested for graphic arts, modeling and crafts.
- 1/4 NPT adapter suction feed.



ITEM	CAPACITY	WORK PRESSURE		AVAILABLE
PA2	0.67 oz (20 ml)	35 psi	1	On Request



usa.urrea.com

## AIR POLISHER

### PNEUMATIC POLISHER



URREA  
IMPROVED PRODUCT



ITEM	UP869P
USE	HEAVY DUTY
NO-LOAD SPEED	2,500 rpm
WHEEL	7"
AIR CONSUMPTION	4.2 SCFM
TYPE	Angular
WEIGHT	5 lb (2.3 kg)
	1
AVAILABLE	✓

- 7" base.
- Speed control for desired use.
- Auxiliary side handle.
- Robust angled head design.
- Fully polished aluminum alloy body.



### PNEUMATIC POLISHER



URREA  
IMPROVED PRODUCT



ITEM	UP865S
USE	HEAVY DUTY
NO-LOAD SPEED	4,000 rpm
WHEEL	7"
AIR CONSUMPTION	6 SCFM
TYPE	Vertical
WEIGHT	5.3 lb (2.4 kg)
	1
AVAILABLE	✓

- Automatic shut-off trigger activates instantly when released
- Ergonomic handle with comfort grip for safe, fatigue-free operation



PNEUMATIC TOOLS

## AIR RIVETER

### AIR RIVETER



URREA  
IMPROVED PRODUCT



ITEM	UP884
USE	HEAVY DUTY
RIVET CAPACITY	3/32", 1/8", 5/32", 3/16", 1/4"
TRACTION FORCE	2,100 lb
AIR CONSUMPTION	30 scfm
WORKING PRESSURE	90 psi
AIR INLET	1/4" NPT
WEIGHT	3.4 lb (1.5 kg)
	1
AVAILABLE	✓
NOZZLES	
	3/32"
	1/8"
	3/16"
	1/4"

- Vacuum assist system designed for greater efficiency when riveting downward.
  - Interchangeable nozzles from 3/32" to 1/4".
- Improved product will be supplied according to inventory rotation.*





AIR DRILLS

AIR DRILL



URREA



ITEM	UP785
USE	
CHUCK	3/8"
NO-LOAD SPEED	1,800 rpm
TYPE	Non-reversible
AIR CONSUMPTION	30 SCFM
WORKING PRESSURE	90 psi
AIR INLE	1/4" NPT
WEIGHT	2.4 lb (1.0 kg)
	1
AVAILABLE	✓



•Non-reversible

AIR DRILL



URREA



ITEM	UP788R
USE	
CHUCK	3/8"
NO-LOAD SPEED	1,800 rpm
TYPE	Reversible
AIR CONSUMPTION	30 SCFM
WORKING PRESSURE	90 psi
AIR INLET	1/4" NPT
WEIGHT	2.4 lb (1.0 kg)
	1
AVAILABLE	✓



•Reversible.

AIR DRILL



URREA



ITEM	UP879
USE	
CHUCK	3/8"
NO-LOAD SPEED	1,800 rpm
TYPE	Non-reversible
AIR CONSUMPTION	30 SCFM
WORKING PRESSURE	90 psi
AIR INLET	1/4" NPT
WEIGHT	2.4 lb (1.0 kg)
	1
AVAILABLE	✓



•Non-reversible angular.  
Improved product will be supplied according to inventory rotation.

AIR DRILL



URREA



ITEM	UP785H
USE	
CHUCK	1/2"
NO-LOAD SPEED	700 rpm
TYPE	Non-reversible
AIR CONSUMPTION	25 SCFM
WORKING PRESSURE	90 psi
AIR INLET	1/4" NPT
WEIGHT	3 lb (1.3 kg)
	1
AVAILABLE	✓



•Auxiliary grip handle  
•Non-reversible

## AIR DRILLS

### AIR DRILL



ITEM	UP789HR
USE	HEAVY DUTY
CHUCK	1/2"
NO-LOAD SPEED	700 rpm
TYPE	Reversible
AIR CONSUMPTION	25 SCFM
WORKING PRESSURE	90 psi
AIR INLET	1/4" NPT
WEIGHT	3 lb (1.3 kg)
	1
AVAILABLE	✓

- Auxiliary grip handle
- Reversible



### FORWARD-REVERSIBLE PNEUMATIC DRILL



ITEM	TN512
USE	PROFESSIONAL USE
CHUCK	1/2"
NO-LOAD SPEED	700 rpm
AIR FLOW	4 CFM
WORKING PRESSURE	90 psi
AIR INLET	1/4" NPT
TYPE	Reversible
WEIGHT	3.1 lb (1.4 kg)
	1
AVAILABLE	✓

- Reversible.



### FORWARD-REVERSIBLE PNEUMATIC DRILL



ITEM	TN538
USE	PROFESSIONAL USE
CHUCK	3/8"
NO-LOAD SPEED	1,800 rpm
AIR FLOW	4 CFM
WORKING PRESSURE	90 psi
AIR INLET	1/4" NPT
TYPE	Reversible
WEIGHT	2.45 lb (1.1 kg)
	1
AVAILABLE	On Request

- Reversible.



PNEUMATIC TOOLS

**URREA**  
SUPERIOR QUALITY AFFORDABLE TOOLS



**SUPERIOR  
Power**

usa.urrea.com

AIR DRILL



CLASS	TYPE	PAGE	BRAND	
			URRER	SURTEK
Chisels	SDS chisels	515	•	•
Drill bits	Concrete drill bits	515	•	•
	Wood drill bits	518	•	•
	Metal drill bits	522	•	•
	Glass and tile drill bits	534	•	•
Brace for wood	Hand brace	534		•
Lathe bit	Lathe bit	534	•	
Wire wheel brushes	Cup wire brushes	535	•	•
	Circular wire brushes	537	•	•
Wire brushes	Wire brushes	540	•	•
Hand planes and spokeshaves	Hand planes	541		•
Hole saw	Hole saw	542	•	•
Cutters	Cutters	544	•	
Glass cutter	Glass cutter	545	•	•
Cutters, knives and pocket knives	Cutters, razors and knives	546	•	•
Carving tool	Carving tool	553		•
Files	Files	553	•	•
Taps	High speed steel taps	558	•	•
	Carbon steel taps	559		•
Mounted stones	Mounted stones	560	•	
Sharpening stones	Scythe stone	560		•
Abrasive disc	Abrasive disc	561		•
Blades and saws	Hacksaws	562	•	•
	Handsaws	564	•	•

usa.urrea.com

We are constantly improving our products, that is why the information, characteristics and availability of them can change without prior notice.

## SUGGESTED USE FOR BEST PERFORMANCE IN URREA DRILL BITS LINE

DRILL BITS		LEVEL USE	WORK MATERIALS																													
			Steel	Stainless steel	Castings steel	Iron *	Titanium	Aluminum	Magnesium	Bronze	Copper	Brass	Regular steel sheet	Construction rod	Concrete **	Concrete with rod	Precast concrete	Brick	Plaster	Wood	Acrylic sheet	Plastic	Granite	Stone	Carbide ***	Molybdenum	Nickel	Vanadium	Glass	Tile		
HIGH SPEED STEEL ***		URRER SUPER DUTY	✓	✓	✓	✓		✓	✓	✓	✓	✓	✓							✓	✓	✓										
		URRER HEAVY DUTY	✓	✓	✓	✓	✓	✓	✓	✓	✓	✓	✓								✓	✓	✓									
		URRER INDUSTRIAL DUTY	✓	✓	✓	✓	✓	✓	✓	✓	✓	✓	✓								✓	✓	✓									
		SURTEK PROFESSIONAL USE	✓		✓	✓		✓		✓	✓	✓	✓								✓		✓									
		SURTEK PROFESSIONAL USE	✓		✓	✓		✓		✓	✓	✓	✓								✓											
		URRER HEAVY DUTY	✓		✓	✓		✓	✓	✓	✓	✓	✓								✓	✓	✓									
		URRER HEAVY DUTY	✓		✓	✓		✓	✓	✓	✓	✓	✓								✓	✓	✓									
		URRER HEAVY DUTY	✓		✓	✓		✓	✓	✓	✓	✓	✓								✓	✓	✓									
		URRER INDUSTRIAL DUTY	✓		✓	✓		✓	✓	✓	✓	✓	✓								✓	✓	✓									
		SURTEK GENERAL USE	✓		✓	✓						✓	✓	✓							✓		✓									
CONCRETE		URRER SUPER DUTY													✓			✓	✓				✓	✓								
		URRER HEAVY DUTY													✓			✓						✓								
		SURTEK PROFESSIONAL USE													✓		✓	✓	✓				✓									
		URRER SUPER DUTY													✓	✓		✓						✓								
		URRER INDUSTRIAL DUTY													✓			✓						✓								
		SURTEK PROFESSIONAL USE													✓		✓	✓	✓					✓								
WOOD		URRER INDUSTRIAL DUTY																			✓											
		SURTEK PROFESSIONAL USE																				✓										
		URRER INDUSTRIAL DUTY																				✓										
		SURTEK PROFESSIONAL USE																					✓									
		URRER INDUSTRIAL DUTY																					✓									
		SURTEK PROFESSIONAL USE																						✓								
CENTER CENTER		URRER HEAVY DUTY	✓	✓	✓			✓	✓	✓	✓	✓																				
		SURTEK PROFESSIONAL USE			✓																											
GLASS COUNTERSINKS STEP DRILL		URRER INDUSTRIAL DUTY			✓			✓		✓	✓	✓											✓									
		SURTEK PROFESSIONAL USE			✓			✓		✓	✓	✓											✓									
		SURTEK PROFESSIONAL USE	✓					✓			✓									✓		✓										
		SURTEK PROFESSIONAL USE																												✓	✓	

\*Iron: Ductile iron, cast iron, gray iron.

\*\*Concrete: Wet concrete, soft concrete

\*\*\*Carbide: Cemented carbide, tungsten carbide.

\*\*\*\*High Speed Steel (HSS): Standard, metric, extra-long, general use, numeric and alphabetic.

CUTTING AND GRINDING TOOLS

**SDS MAX & SDS PLUS CHISELS**

**SDS MAX CHISELS**



• Ideal for standard chiseling in concrete and brick, suitable for a wide range of demolition applications.

ITEM	DESCRIPTION	LENGTH	DIAMETER	Ø	AVAILABLE
117520	Helical	410 mm	18 mm	1	✓
117522	Flat	410 mm	18 mm	1	✓
117524*	Wide flat	410 mm	18 mm	1	✓



**SDS PLUS CHISELS**

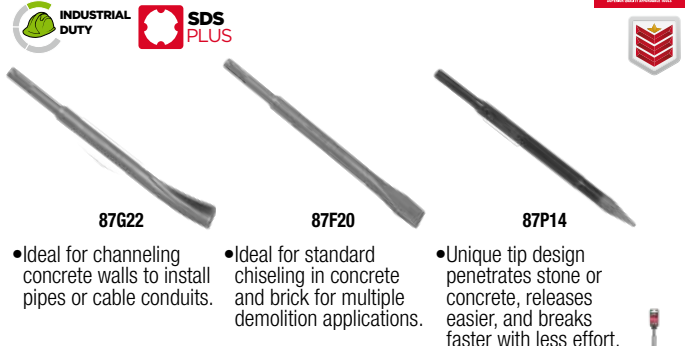

- Ideal for channeling concrete walls to install pipes or cable conduits.
- Ideal for standard chiseling in concrete and brick for multiple demolition applications.
- Unique tip design penetrates stone or concrete, releases easier, and breaks faster with less effort.

• Manufactured from steel.

ITEM	DESCRIPTION	LENGTH	DIAMETER	Ø	AVAILABLE
87G22	Gouging	10"	7/8"	1	On Request
87F20	Flat	10"	13/16"	1	On Request
87P14	Helical	10"	9/16"	1	On Request

**SDS PLUS CHISELS**



- Manufactured from steel.
- Ideal for standard chiseling in concrete and brick for multiple demolition applications.

ITEM	DESCRIPTION	LENGTH	DIAMETER	Ø	AVAILABLE
117533	Pointed	10"	3/8"	1	On Request
117534	Flat	10"	3/8"	1	On Request
117535	Wide flat	10"	3/8"	1	On Request



**CONCRETE DRILL BITS**

**SDS MAX CONCRETE DRILL BITS**

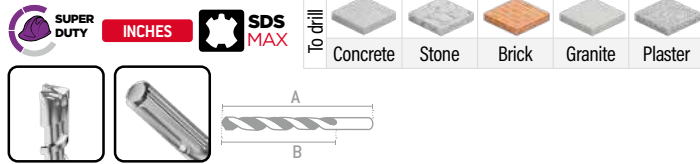

- Manufactured from steel with tungsten carbide tip.
- Progressive core channel ensures the thicker part of the spiral maintains higher friction during drilling, delivering greater resistance to wear.
- Features self-centering point, side supports, and six cutting edges.
- Reinforced head and tungsten carbide inserts provide drilling capability in both concrete and metal while reducing tool vibration.

ITEM	SIZE	TOTAL LENGTH (A)	FLUTE LENGTH (B)	Ø	AVAILABLE
BMAX5/8X13	5/8"	13"	8"	1	On Request
BMAX5/8X21	5/8"	21"	15"	1	On Request
BMAX5/8X36	5/8"	36"	30"	1	On Request
BMAX3/4X13	3/4"	13"	8"	1	On Request
BMAX3/4X21	3/4"	21"	15"	1	On Request
BMAX3/4X36	3/4"	36"	30"	1	On Request
BMAX7/8X13	7/8"	13"	8"	1	On Request
BMAX7/8X21	7/8"	21"	15"	1	On Request
BMAX7/8X36	7/8"	36"	30"	1	On Request
BMAX1X13	1"	13"	8"	1	On Request
BMAX1X21	1"	21"	15"	1	On Request
BMAX1X36	1"	36"	30"	1	On Request



ITEM	SIZE	TOTAL LENGTH (A)	FLUTE LENGTH (B)	Ø	AVAILABLE
BMAX11/8X13	1-1/8"	13"	8"	1	On Request
BMAX11/8X21	1-1/8"	21"	15"	1	On Request
BMAX11/8X36	1-1/8"	36"	30"	1	On Request
BMAX11/4X21	1-1/4"	21"	15"	1	On Request
BMAX11/4X36	1-1/4"	36"	30"	1	On Request
BMAX13/8X21	1-3/8"	21"	15"	1	On Request
BMAX13/8X36	1-3/8"	36"	30"	1	On Request
BMAX11/2X21	1-1/2"	21"	15"	1	On Request
BMAX11/2X36	1-1/2"	36"	30"	1	On Request
BMAX13/4X21	1-3/4"	21"	15"	1	On Request
BMAX13/4X36	1-3/4"	36"	30"	1	On Request

## CONCRETE DRILL BITS

### SDS PLUS PREMIUM CONCRETE DRILL BITS



**INCHES** **SDS PLUS**



**BSDSP1/4X4**

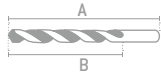

- Manufactured from chrome-nickel-molybdenum steel.
- Monoblock insert with three cutting edges delivers perfect hole geometry and ensures optimal transfer of hammering and rotation energy.
- Three cutting edges provide perfectly round drilling and high resistance when cutting through rebar.

ITEM	SIZE	TOTAL LENGTH (A)	FLUTE LENGTH (B)	☞	AVAILABLE
BSDSP1/4X4	1/4"	4"	1-7/8"	1	
BSDSP1/4X6	1/4"	6"	4"	1	
BSDSP1/4X8	1/4"	8"	6"	1	
BSDSP1/4X12	1/4"	12"	10"	1	
BSDSP5/16X6	5/16"	6"	4"	1	
BSDSP5/16X12	5/16"	12"	10"	1	
BSDSP3/8X4	3/8"	4"	2"	1	
BSDSP3/8X6	3/8"	6"	4"	1	
BSDSP3/8X8	3/8"	8"	6"	1	
BSDSP3/8X12	3/8"	12"	10"	1	
BSDSP1/2X6	1/2"	6"	3-5/32"	1	

ITEM	SIZE	TOTAL LENGTH (A)	FLUTE LENGTH (B)	☞	AVAILABLE
BSDSP1/2X8	1/2"	8"	6"	1	
BSDSP1/2X12	1/2"	12"	9"	1	
BSDSP1/2X18	1/2"	18"	16"	1	
BSDSP9/16X6	9/16"	6"	10"	1	
BSDSP9/16X12	9/16"	12"	4"	1	
BSDSP5/8X6	5/8"	6"	3"	1	
BSDSP5/8X8	5/8"	8"	6"	1	
BSDSP5/8X12	5/8"	12"	8-7/8"	1	
BSDSP3/4X8	3/4"	8"	4-3/4"	1	
BSDSP3/4X12	3/4"	12"	10"	1	
BSDSP3/4X18	3/4"	18"	14-9/16"	1	

### SDS PLUS CONCRETE DRILL BITS



**INCHES** **SDS PLUS**



**BSDS3/16X6**

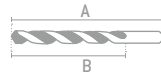

- Manufactured from steel with thin carbide tip.
- Two-flute square spiral combines a compression chamber and a vacuum chamber, accelerating dust removal up to 30% faster than any conventional straight-shank bit.
- Tungsten carbide insert with dual cutters provides a larger impact surface and concentrated strike point for superior percussion performance.
- Fully hardened to withstand high torque, bending, and compression.

ITEM	SIZE	TOTAL LENGTH (A)	FLUTE LENGTH (B)	☞	AVAILABLE
BSDS3/16X4	3/16"	4"	2"	1	On Request
BSDS3/16X6	3/16"	6"	4"	1	On Request
BSDS3/16X8	3/16"	8"	6"	1	On Request
BSDS7/32X6	7/32"	6"	4"	1	On Request
BSDS1/4X4	1/4"	4"	2"	1	On Request
BSDS1/4X6	1/4"	6"	4"	1	On Request
BSDS1/4X8	1/4"	8"	6"	1	On Request
BSDS1/4X12	1/4"	12"	10"	1	On Request
BSDS5/16X4	5/16"	4"	2"	1	On Request
BSDS5/16X6	5/16"	6"	4"	1	On Request
BSDS5/16X8	5/16"	8"	6"	1	On Request
BSDS5/16X12	5/16"	12"	10"	1	On Request
BSDS5/16X18	5/16"	18"	16"	1	On Request
BSDS3/8X6	3/8"	6"	4"	1	On Request
BSDS3/8X8	3/8"	8"	6"	1	On Request
BSDS3/8X12	3/8"	12"	10"	1	✓
BSDS3/8X18	3/8"	18"	16"	1	On Request
BSDS3/8X24	3/8"	24"	21"	1	On Request
BSDS1/2X6	1/2"	6"	4"	1	On Request
BSDS1/2X8	1/2"	8"	6"	1	On Request

ITEM	SIZE	TOTAL LENGTH (A)	FLUTE LENGTH (B)	☞	AVAILABLE
BSDS1/2X12	1/2"	12"	10"	1	On Request
BSDS1/2X18	1/2"	18"	16"	1	On Request
BSDS1/2X24	1/2"	24"	22"	1	On Request
BSDS9/16X6	9/16"	6"	4"	1	On Request
BSDS9/16X12	9/16"	12"	10"	1	On Request
BSDS5/8X6	5/8"	6"	4"	1	On Request
BSDS5/8X8	5/8"	8"	6"	1	On Request
BSDS5/8X12	5/8"	12"	10"	1	On Request
BSDS5/8X18	5/8"	18"	16"	1	On Request
BSDS5/8X24	5/8"	24"	21"	1	On Request
BSDS3/4X6	3/4"	6"	4"	1	On Request
BSDS3/4X8	3/4"	8"	6"	1	On Request
BSDS3/4X12	3/4"	12"	10"	1	On Request
BSDS3/4X18	3/4"	18"	16"	1	On Request
BSDS7/8X10	7/8"	10"	8"	1	✓
BSDS7/8X12	7/8"	12"	10"	1	On Request
BSDS7/8X18	7/8"	18"	16"	1	On Request
BSDS1X12	1"	12"	10"	1	On Request
BSDS1X18	1"	18"	16"	1	✓

**CONCRETE DRILL BITS**

**SDS PLUS MASONRY DRILL BIT**



INCHES



119213

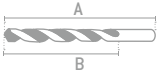

- Manufactured from steel with carbide tip.
- Double-flute spiral provides higher drilling speed and improved chip removal.

ITEM	SIZE	TOTAL LENGTH (A)	FLUTE LENGTH (B)	Ø	AVAILABLE
119204	1/4"	4"	1-1/4"	1	On Request
119205	1/4"	6"	3-1/8"	1	On Request
119206	1/4"	12"	9-1/4"	1	On Request
119208	5/16"	6"	3-1/8"	1	On Request
119209	5/16"	12"	9-1/4"	1	On Request
119210	3/8"	6"	3-1/8"	1	On Request
119211	3/8"	12"	9-1/4"	1	On Request
119212	3/8"	18"	15-3/8"	1	On Request
119213	1/2"	6"	3-1/8"	1	On Request

ITEM	SIZE	TOTAL LENGTH (A)	FLUTE LENGTH (B)	Ø	AVAILABLE
119214	1/2"	12"	9-1/4"	1	On Request
119215	1/2"	18"	15-3/8"	1	On Request
119216	5/8"	6"	3"	1	On Request
119217	5/8"	12"	9"	1	On Request
119218	3/4"	6"	2-3/4"	1	On Request
119219	3/4"	12"	8-5/8"	1	On Request
119220	7/8"	12"	8-5/8"	1	On Request
119221	1"	12"	8-5/8"	1	On Request

**STRAIGHT SHANK CONCRETE DRILL BITS**



INCHES



BCN386



- Rolled and shot-blasted steel provides a flawless surface finish and corrosion resistance.
- Heat treatment increases abrasion resistance, reduces burr adhesion, and ensures bit straightness.
- Ideal for drilling in concrete, stone, and masonry.
- Tungsten carbide insert increases drilling speed by 20%.

ITEM	SIZE	TOTAL LENGTH (A)	FLUTE LENGTH (B)	Ø	AVAILABLE
BCN183	1/8"	3"	1-9/16"	8	✓
BCN3164	3/16"	4"	2-5/32"	8	On Request
BCN3166	3/16"	6"	3-3/4"	8	On Request
BCN144	1/4"	4"	2-5/32"	8	On Request
BCN146	1/4"	6"	3-3/4"	8	✓
BCN1412	1/4"	12"	6-13/16"	8	✓
BCN5164	5/16"	4"	2-5/32"	8	On Request
BCN5166	5/16"	6"	3-3/4"	8	✓
BCN51612	5/16"	12"	6-13/16"	8	On Request
BCN386	3/8"	6"	3-11/32"	8	✓

ITEM	SIZE	TOTAL LENGTH (A)	FLUTE LENGTH (B)	Ø	AVAILABLE
BCN3812	3/8"	12"	6-13/16"	8	On Request
BCN126	1/2"	6"	3-11/32"	8	✓
BCN1212	1/2"	12"	6-13/16"	8	On Request
BCN586	5/8"	6"	3-11/32"	3	✓
BCN5812	5/8"	12"	6-13/16"	3	On Request
BCN346	3/4"	6"	3"	3	✓
BCN3412	3/4"	12"	6-13/16"	3	On Request
BCN786	7/8"	6"	3-1/2"	3	✓
BCN7812	7/8"	12"	8"	3	On Request

## CONCRETE DRILL BITS

### STRAIGHT SHANK MASONRY DRILL BIT



INCHES

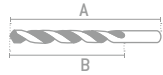

119155

- Tungsten carbide tip.
- Double flute for efficient material removal.

ITEM	SIZE	TOTAL LENGTH (A)	FLUTE LENGTH (B)	Ø	AVAILABLE	DRILL BIT SET
119153	1/8"	3"	1-4/5"	10	On Request	119191 6
119155	3/16"	4"	2-2/5"	10	On Request	
119154	3/16"	6"	3-3/5"	10	On Request	Includes 2 drill bits of 1/4" x 4".
119156	1/4"	4"	2-2/5"	10	On Request	
119157	1/4"	6"	3-3/5"	5	On Request	• x 2
119158	1/4"	12"	7-1/5"	5	On Request	•
119159	5/16"	4"	2-2/5"	5	On Request	•
119170	5/16"	6"	3-3/5"	5	On Request	
119160	5/16"	12"	7-1/5"	5	On Request	
119161	3/8"	6"	3-3/5"	5	On Request	•
119162	3/8"	12"	7-1/5"	5	On Request	
119181	3/8"	24"	14-2/5"	5	On Request	
119163	1/2"	6"	3-3/5"	5	On Request	
119164	1/2"	12"	7-1/5"	5	On Request	
119182	1/2"	24"	14-2/5"	5	On Request	
119165	5/8"	6"	3-3/5"	1	On Request	
119166	5/8"	12"	7-1/5"	1	On Request	
119183	5/8"	24"	14-2/5"	1	On Request	
119167	3/4"	6"	3-3/5"	1	On Request	
119168	3/4"	12"	7-1/5"	1	On Request	
119184	3/4"	24"	14-2/5"	1	On Request	
119171	7/8"	6"	3-3/5"	1	On Request	
119172	7/8"	12"	7-1/5"	1	On Request	
119169	1"	6"	3-3/5"	1	On Request	
119173	1"	12"	7-1/5"	1	On Request	



NEW

CUTTING AND GRINDING TOOLS

## WOOD DRILL BITS

### HEX SHANK FORSTNER BITS



INCHES



BF1-3/8

- Manufactured from T10 carbon steel.
- Self-centering tip.
- Eight cutting edges for fast and precise drilling.
- Hex shank with slot for secure grip in portable power tools.
- Ideal for flat-bottom drilling (e.g., hinge recesses).



### FORSTNER DRILL BIT



INCHES



119318

- Manufactured from carbon steel.
- Self-centering tip.
- Ideal for flat-bottom drilling.

ITEM	SIZE	TOTAL LENGTH	SHANK	Ø	AVAILABLE
119316	1"	3-3/4"	7/16"	1	✓
119318	1-1/4"	3-3/4"	7/16"	1	On Request
119319	1-3/8"	3-3/4"	7/16"	1	✓





**WOOD DRILL BITS**

**WOOD AUGER BIT**



INCHES



**BMG1**

- Manufactured from carbon steel.
- Self-centering tip.
- Deep flute for fast chip ejection.
- Hex shank with slot for secure grip in portable power tools.
- Ideal for fast, precise drilling in thick or wet wood.

ITEM	SIZE	TOTAL LENGTH	SHANK	⊞	AVAILABLE
BMG1/4	1/4"	6"	1/4"	1	On Request
BMG5/16	5/16"	6"	5/16"	1	On Request
BMG3/8	3/8"	6"	3/8"	1	On Request
BMG7/16	7/16"	6"	3/8"	1	On Request
BMG1/2	1/2"	6"	3/8"	1	On Request
BMG9/16	9/16"	6"	7/16"	1	On Request
BMG5/8	5/8"	6"	7/16"	1	On Request
BMG3/4	3/4"	6"	1/2"	1	On Request
BMG7/8	7/8"	6"	1/2"	1	On Request
BMG1	1"	6"	1/2"	1	On Request
BMG1-1/8	1-1/8"	6"	1/2"	1	On Request
BMG1-1/4	1-1/4"	6"	1/2"	1	On Request
BMG1-1/2	1-1/2"	6"	1/2"	1	On Request

**HEX SHANK WOOD FLAT BITS**



INCHES



**BMM7/8**

- Manufactured from high-speed carbon steel.
- Self-centering tip.
- Triple cutting edge for fast and precise drilling.
- Fast chip evacuation and clean, splinter-free holes.
- Hex shank with slot for secure grip in portable power tools.

DRILL BIT SET					
ITEM	SIZE	TOTAL LENGTH	SHANK	⊞	AVAILABLE
BMM1/4	1/4"	6"	1/4"	1	On Request
BMM5/16	5/16"	6"	1/4"	1	On Request
BMM3/8	3/8"	6"	1/4"	1	On Request
BMM7/16	7/16"	6"	1/4"	1	On Request
BMM1/2	1/2"	6"	1/4"	1	On Request
BMM5/8	5/8"	6"	1/4"	1	On Request
BMM3/4	3/4"	6"	1/4"	1	On Request
BMM7/8	7/8"	6"	1/4"	1	On Request
BMM1	1"	6"	1/4"	1	On Request
BMM1-1/8	1-1/8"	6"	1/4"	1	On Request
BMM1-1/4	1-1/4"	6"	1/4"	1	On Request
BMM1-3/8	1-3/8"	6"	1/4"	1	On Request
BMM1-1/2	1-1/2"	6"	1/4"	1	On Request

**WOOD AUGER BIT 2 ON 1**



INCHES

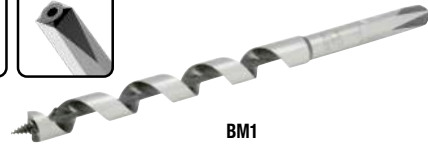

**BM1**

- Manufactured from carbon steel.
- Self-centering tip.
- 2-in-1 shank allows use with both hand brace and power tools.
- Two blades and two cutting edges.

ITEM	SIZE	TOTAL LENGTH	SHANK	⊞	AVAILABLE
BM1/4	1/4"	7-7/8"	7/16"	1	On Request
BM5/16	5/16"	7-7/8"	7/16"	1	On Request
BM3/8	3/8"	7-7/8"	7/16"	1	On Request
BM7/16	7/16"	7-7/8"	7/16"	1	On Request
BM1/2	1/2"	7-7/8"	7/16"	1	On Request
BM9/16	9/16"	7-7/8"	7/16"	1	On Request
BM5/8	5/8"	7-7/8"	7/16"	1	On Request
BM3/4	3/4"	7-7/8"	7/16"	1	On Request
BM7/8	7/8"	7-7/8"	7/16"	1	On Request
BM1	1"	7-7/8"	7/16"	1	On Request

**HEX SHANK WOOD FLAT DRILL BIT**



INCHES



**BP1**

- Manufactured from carbon steel.
- Self-centering tip.
- Triple cutting edge for fast and precise drilling.
- Hex shank with slot for secure grip in portable power tools.

DRILL BIT SET					
ITEM	SIZE	TOTAL LENGTH	SHANK	⊞	AVAILABLE
BP1/4	1/4"	6"	1/4"	1	On Request
BP5/16	5/16"	6"	1/4"	1	✓
BP3/8	3/8"	6"	1/4"	1	On Request
BP7/16	7/16"	6"	1/4"	1	✓
BP1/2	1/2"	6"	1/4"	3	✓
—	9/16"	Not available for individual sale			•
BP5/8	5/8"	6"	1/4"	3	✓
—	11/16"	Not available for individual sale			•
BP3/4	3/4"	6"	1/4"	3	On Request
—	13/16"	Not available for individual sale			•
BP7/8	7/8"	6"	1/4"	3	On Request
—	15/16"	Not available for individual sale			•
BP1	1"	6"	1/4"	3	On Request
BP1 1/8	1-1/8"	6"	1/4"	3	✓
BP1 1/4	1-1/4"	6"	1/4"	3	On Request
BP1 1/2	1-1/2"	6"	1/4"	3	✓

## WOOD DRILL BITS

### CORE BOX BIT

INDUSTRIAL DUTY INCHES



BR1406

•Tungsten carbide blade.

ITEM	SIZE	SHANK	⊞	AVAILABLE
BR1404	1/4" x 1/4"	1/4"	1	On Request
BR1405	3/8" x 9/32"	1/4"	1	On Request
BR1406	1/2" x 3/8"	1/4"	1	On Request
BR1407	3/4" x 7/16"	1/4"	1	On Request
BR1201	1-1/8" x 11/16"	1/2"	1	On Request



### CORE BOX BIT

PROFESSIONAL USE INCHES



119259

ITEM	SIZE	SHANK	⊞	AVAILABLE
119257	1/4" x 1/4"	1/4"	1	On Request
119258	3/8" x 1/4"	1/4"	1	On Request
119259	1/2" x 3/8"	1/4"	1	On Request
119260	3/4" x 7/16"	1/4"	1	On Request



NEW

### RABBETING BIT WITH BEARING

INDUSTRIAL DUTY INCHES



BR1207

•Tungsten carbide blade.

ITEM	SIZE	SHANK	⊞	AVAILABLE
BR1426	1-1/4" x 1/2"	1/4"	1	On Request
BR1207	1-1/4" x 5/8"	1/2"	1	On Request



### RABBETING BIT WITH BEARING

PROFESSIONAL USE INCHES



NEW

ITEM	SIZE	SHANK	⊞	AVAILABLE
119263	1-1/4" x 1/2"	1/4"	6	On Request



### CURVED LINE BIT WITH BEARING

INDUSTRIAL DUTY INCHES



BR1423

•Tungsten carbide blade.

ITEM	SIZE	SHANK	⊞	AVAILABLE
BR1423	1-1/8" x 5/8"	1/4"	6	On Request
BR1424	1-3/8" x 7/8"	1/4"	6	On Request



### CURVED LINE BIT WITH BEARING

PROFESSIONAL USE INCHES



119275

ITEM	SIZE	SHANK	⊞	AVAILABLE
119274	1-1/8" x 1/2"	1/4"	6	On Request
119275	1-3/8" x 11/16"	1/4"	1	On Request



### ROUNDING CORNER BIT WITH BEARING

INDUSTRIAL DUTY INCHES



BR1205

•Tungsten carbide blade.

ITEM	SIZE	SHANK	⊞	AVAILABLE
BR1419	1" x 1/4"	1/4"	1	On Request
BR1420	1-1/4" x 5/8"	1/4"	1	On Request
BR1421	1-1/2" x 3/4"	1/4"	1	On Request
BR1205	1-5/8" x 3/4"	1/2"	1	On Request
BR1206	1-3/4" x 7/8"	1/2"	1	On Request



### ROUNDING CORNER BIT WITH BEARING

PROFESSIONAL USE INCHES



119269

ITEM	SIZE	SHANK	⊞	AVAILABLE
119268	1" x 1/2"	1/4"	1	On Request
119269	1-1/4" x 5/8"	1/4"	1	On Request
119270	1-1/2" x 3/4"	1/4"	1	On Request



NEW

### BEADING BIT WITH BEARING

INDUSTRIAL DUTY INCHES



BR1417

•Tungsten carbide blade.

ITEM	SIZE	SHANK	⊞	AVAILABLE
BR1416	1-1/8" x 1/2"	1/4"	1	On Request
BR1417	1-1/4" x 5/8"	1/4"	1	On Request
BR1418	1-1/2" x 3/4"	1/4"	1	On Request



### BEADING BIT WITH BEARING

PROFESSIONAL USE INCHES



119271

ITEM	SIZE	SHANK	⊞	AVAILABLE
119271	1" x 1/2"	1/4"	1	On Request
119272	1-1/4" x 5/8"	1/4"	1	On Request
119273	1-1/2" x 3/4"	1/4"	1	On Request



NEW

### STRAIGHT BIT

INDUSTRIAL DUTY INCHES



BR1409

•Tungsten carbide blade.

ITEM	SIZE	SHANK	⊞	AVAILABLE
BR1408	1/4" x 3/4"	1/4"	1	On Request
BR1409	5/16" x 3/4"	1/4"	1	On Request
BR1410	3/8" x 1"	1/4"	1	On Request
BR1411	1/2" x 1"	1/4"	1	On Request
BR1412	5/8" x 3/4"	1/4"	1	On Request
BR1413	3/4" x 3/4"	1/4"	1	On Request
BR1202	1-1/8" x 1-1/4"	1/2"	1	On Request
BR1203	1-1/4" x 1-1/4"	1/2"	1	On Request



### STRAIGHT BIT

PROFESSIONAL USE INCHES



119253

ITEM	SIZE	SHANK	⊞	AVAILABLE
119250	1/4" x 3/4"	1/4"	1	On Request
119251	1/4" x 1"	1/4"	1	On Request
119252	5/16" x 1"	1/4"	1	On Request
119253	3/8" x 1"	1/4"	1	On Request
119254	1/2" x 1"	1/4"	1	On Request
119255	5/8" x 3/4"	1/4"	1	On Request
119256	3/4" x 3/4"	1/4"	1	On Request



NEW

**WOOD DRILL BITS**

**ROUTER BIT DOVETAIL**



•Tungsten carbide blade.

ITEM	SIZE	SHANK	⊞	AVAILABLE
BR1401	1/4"	1/4"	1	On Request

**ROUTER BIT DOVETAIL**



NEW

ITEM	SIZE	SHANK	⊞	AVAILABLE
119262	1/2" x 1/2", 14°	1/4"	1	On Request

**CLASSICAL OGEE BIT**



•Tungsten carbide blade.

ITEM	SIZE	SHANK	⊞	AVAILABLE
BR1425	1-3/8" x 7/8"	1/4"	1	On Request

**CLASSICAL OGEE BIT**



NEW

ITEM	SIZE	SHANK	⊞	AVAILABLE
119277	1-3/8" x 11/16"	1/4"	1	On Request

**V-GROOVE BIT**



•Tungsten carbide blade.

ITEM	SIZE	SHANK	⊞	AVAILABLE
BR1402	3/8" x 3/8"	1/4"	1	On Request
BR1403	1/2" x 1/2"	1/4"	1	On Request

**V-GROOVE BIT**



NEW

ITEM	SIZE	SHANK	⊞	AVAILABLE
119264	3/8" x 7/16", 90°	1/4"	1	On Request
119265	1/2" x 1/2", 90°	1/4"	1	On Request

**ROMAN OGEE BIT WITH BEARING**



BR1402

•Tungsten carbide blade.

ITEM	SIZE	SHANK	⊞	AVAILABLE
BR1414	1-3/8" x 7/8"	1/4"	1	On Request
BR1204	1-5/8" x 1-1/8"	1/4"	1	On Request

**ROMAN OGEE BIT WITH BEARING**



NEW

ITEM	SIZE	SHANK	⊞	AVAILABLE
119276	1-3/8" x 7/8"	1/4"	1	On Request

**CHAMFER BIT WITH BEARING**



•Tungsten carbide blade.

ITEM	SIZE	SHANK	⊞	AVAILABLE
BR1415	1-1/4" x 1-1/2"	1/4"	1	On Request

**CHAMFER BIT WITH BEARING**



NEW

ITEM	SIZE	SHANK	⊞	AVAILABLE
119267	1-1/4" x 1/2", 45°	1/4"	1	On Request

**CLASSICAL MOULDING BIT**



•Tungsten carbide blade.

ITEM	SIZE	SHANK	⊞	AVAILABLE
BR1427	1-3/8" x 7/8"	1/4"	1	On Request

**CLASSICAL MOULDING BIT**



NEW

ITEM	SIZE	SHANK	⊞	AVAILABLE
119279	1-1/8" x 9/16"	1/4"	1	On Request

**COVE BIT WITH BEARING**



•Tungsten carbide blade.

ITEM	SIZE	SHANK	⊞	AVAILABLE
BR1422	1-1/8" x 5/8"	1/4"	1	On Request

**COVE BIT WITH BEARING**



NEW

ITEM	SIZE	SHANK	⊞	AVAILABLE
119278	1-1/8" x 9/16"	1/4"	1	On Request



usa.urrea.com

## STEEL DRILL BITS

### PREMIUM HIGH SPEED STEEL DRILL BITS AND TAPS IN METAL DRILL INDEX BOX SET

**SUPER DUTY**  
**18**  
PIECES COMBINED



Drill bits size	Taps size
#36	6-32NC
#29	8-32NC
#25	10-24NC
#21	10-32NF
#7	1/4-20NC
F	5/16-18NC
5/16"	3/8-16NC
U	7/16-14NC
2764	1/2-13NC



**METAL BOX**

ITEM	PIECES	PRESENTATION	☞	AVAILABLE
H5118MC	18	Metal box	1	✓

### PREMIUM HIGH SPEED STEEL DRILL BITS AND SCREW EXTRACTORS IN METAL DRILL INDEX BOX SET

**SUPER DUTY**  
**10**  
PIECES COMBINED



Drill bits size	Taps size
3/32"	5/64"
1/8"	7/64"
3/16"	5/32"
1/4"	1/4"
5/16"	17/64"



**METAL BOX**

ITEM	PIECES	PRESENTATION	☞	AVAILABLE
9500LD	10	Metal box	1	✓

### PREMIUM HIGH SPEED STEEL 3-FLAT SHANK DRILL BITS

**SUPER DUTY**  
**INCHES**

**M35**  
STEEL

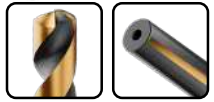

Three-flat shank prevents slipping.



BH29/64

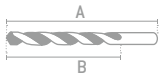

- Manufactured from high-molybdenum steel with 135° angle for fast, precise penetration without pre-punching.
- Nitro-carburized cutting edge withstands high temperatures and stays sharp longer.
- Heat-treated at 1,196 °C.
- Combines the lubricating benefits of black oxide HSS bits with the abrasion resistance of nitride, making them ideal for drilling general steels, non-ferrous materials, and non-metals such as plastics, wood, and rubber.
- Highly recommended for drilling high-hardness steels such as stainless steel.
- Greater hardness than standard high-speed steel.



ITEM	PREMIUM DRILL BIT SET			
	H5129	H5121	H5115	H5113
PIECES	29	21	15	13
PACKING				
☞	1	1	1	1
AVAILABLE	✓	On Request	✓	✓

ITEM	SIZE	TOTAL LENGTH (A)	FLUTE LENGTH (B)	☞	AVAILABLE
BH1/16	1/16"	1-7/8"	7/8"	10	On Request
BH5/64	5/64"	2"	1"	10	✓
BH3/32	3/32"	2-1/4"	1-5/16"	10	✓
BH7/64	7/64"	2-5/8"	1-9/16"	10	✓
BH1/8	1/8"	2-3/4"	1-11/16"	10	On Request
BH9/64	9/64"	2-7/8"	1-13/16"	10	✓
BH5/32	5/32"	3-1/8"	2-1/16"	10	✓
BH11/64	11/64"	3-1/4"	2-3/16"	10	✓
BH3/16	3/16"	3-1/2"	2-3/8"	10	✓
BH13/64	13/64"	3-5/8"	2-1/2"	10	On Request
BH7/32	7/32"	3-13/16"	2-9/16"	10	✓
BH15/64	15/64"	3-15/16"	2-11/16"	10	✓
BH1/4	1/4"	4"	2-13/16"	10	✓
BH17/64	17/64"	4-3/16"	2-15/16"	10	✓
BH9/32	9/32"	4-5/16"	3"	10	✓
BH19/64	19/64"	4-7/16"	3-1/8"	5	✓
BH5/16	5/16"	4-9/16"	3-1/4"	5	✓
BH21/64	21/64"	4-11/16"	3-3/8"	5	✓
BH11/32	11/32"	4-13/16"	3-1/2"	5	On Request
BH23/64	23/64"	4-15/16"	3-9/16"	5	✓
BH3/8	3/8"	5"	3-11/16"	5	✓
BH25/64	25/64"	5-3/16"	3-13/16"	5	✓
BH13/32	13/32"	5-5/16"	3-15/16"	5	On Request
BH27/64	27/64"	5-7/16"	4"	5	✓
BH7/16	7/16"	5-5/8"	4-1/8"	5	✓
BH29/64	29/64"	5-3/4"	4-1/4"	5	✓
BH15/32	15/32"	5-7/8"	4-3/8"	5	✓
BH31/64	31/64"	6"	4-7/16"	5	✓
BH1/2	1/2"	6-1/8"	4-9/16"	5	✓

**STEEL DRILL BITS**

**PREMIUM HIGH SPEED STEEL DRILL BITS REDUCED SHANK**



Three-flate shank prevents slipping.



**BZR5/8**

- Manufactured from M35 steel with 6% cobalt.
- Nitro-carburized cutting edges withstand high drilling temperatures, keeping the bit sharper for longer; gold-colored body features a nitride coating for maximum lubrication.
- Reduced 1/2" shank with three flats for stronger grip, designed for heavy-duty use, with 135° split point tips.
- Also known as Silver & Deming drill bits.
- Recommended for heavy-duty applications.
- 135° split point tips.



ITEM	SIZE	TOTAL LENGTH (A)	FLUTE LENGTH (B)	⊗	AVAILABLE
BZR33/64	33/64"	5"	3-1/8"	1	✓
BZR17/32	17/32"	5"	3-1/8"	1	✓
BZR35/64	35/64"	5"	3-1/8"	1	✓
BZR9/16	9/16"	5"	3-1/8"	1	✓
BZR37/64	37/64"	5"	3-1/8"	1	✓
BZR19/32	19/32"	5"	3-1/8"	1	✓
BZR39/64	39/64"	5"	3-1/8"	1	✓
BZR5/8	5/8"	5"	3-1/8"	1	✓
BZR41/64	41/64"	5"	3-1/8"	1	✓
BZR21/32	21/32"	5"	3-1/8"	1	✓
BZR43/64	43/64"	5"	3-1/8"	1	✓
BZR11/16	11/16"	5"	3-1/8"	1	✓
BZR45/64	45/64"	5"	3-1/8"	1	✓
BZR23/32	23/32"	5"	3-1/8"	1	✓
BZR47/64	47/64"	5"	3-1/8"	1	✓
BZR3/4	3/4"	5"	3-1/8"	1	✓
BZR49/64	49/64"	5"	3-1/8"	1	✓
BZR25/32	25/32"	5"	3-1/8"	1	✓
BZR51/64	51/64"	5"	3-1/8"	1	✓
BZR13/16	13/16"	5"	3-1/8"	1	✓
BZR53/64	53/64"	5"	3-1/8"	1	✓
BZR27/32	27/32"	5"	3-1/8"	1	✓
BZR55/64	55/64"	5"	3-1/8"	1	✓
BZR7/8	7/8"	5"	3-1/8"	1	On Request
BZR57/64	57/64"	5"	3-1/8"	1	✓
BZR29/32	29/32"	5"	3-1/8"	1	✓
BZR59/64	59/64"	5"	3-1/8"	1	✓
BZR15/16	15/16"	5"	3-1/8"	1	✓
BZR61/64	61/64"	5"	3-1/8"	1	✓
BZR31/32	31/32"	5"	3-1/8"	1	✓
BZR63/64	63/64"	5"	3-1/8"	1	✓
BZR1	1"	5"	3-1/8"	1	✓

CUTTING AND GRINDING TOOLS

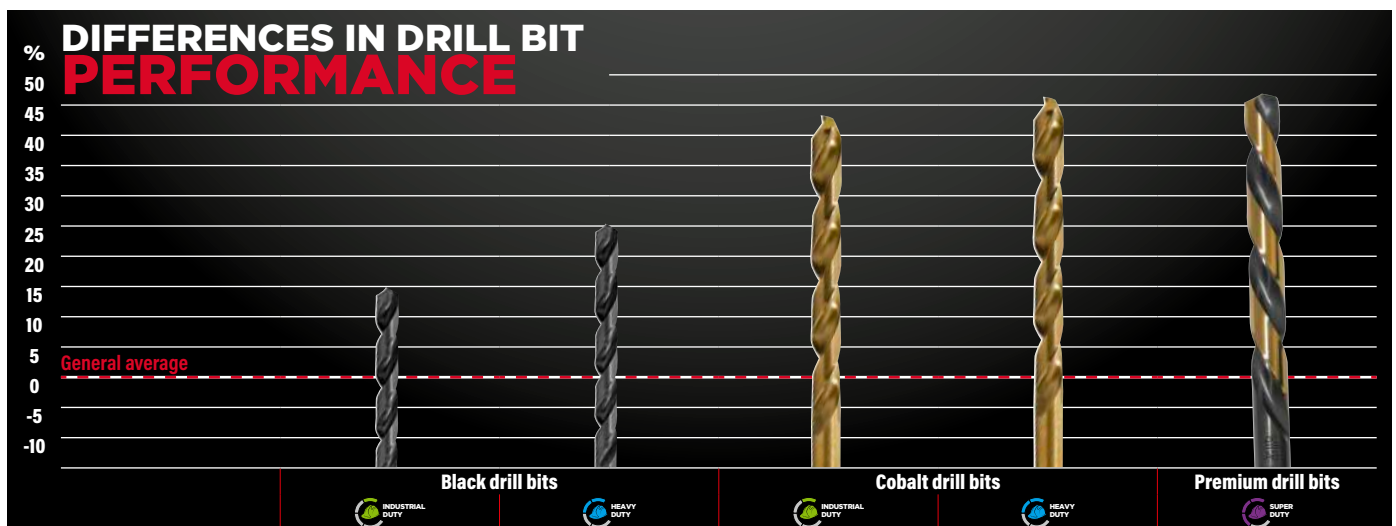

## STEEL DRILL BITS

### COBALT HIGH SPEED STEEL STRAIGHT SHANK DRILL BITS



INCHES



URREA



BC1/4

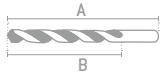

- Manufactured from M35 steel with 6% cobalt.
- Delivers 45% longer life compared to general-purpose drill bits.
- Capable of drilling all types of materials without percussion.
- Long-lasting, gold-finish bits with 135° split point for faster, more precise cutting in high-hardness metals such as stainless steel, cast iron, aluminum, copper, brass, high-temperature alloys, titanium, and certain plastics.
- High cobalt hardness allows operating at 30% higher speeds than conventional high-speed steel bits.



#### COBALT HIGH SPEED STEEL STRAIGHT SHANK DRILL BITS SETS

ITEM	C5129	C5115
PIECES	29	15
PACKING		
DISPENSER	4079	4077
Ⓢ	1	1

ITEM	SIZE	TOTAL LENGTH (A)	FLUTE LENGTH (B)	Ⓢ	AVAILABLE	On Request	On Request
BC1/16	1/16"	1-7/8"	7/8"	10	✓	•	•
BC5/64	5/64"	2"	1"	10	On Request	•	
BC3/32	3/32"	2-1/4"	1-1/4"	10	✓	•	•
BC7/64	7/64"	2-5/8"	1-1/2"	10	✓	•	
BC1/8	1/8"	2-3/4"	1-5/8"	10	✓	•	•
BC9/64	9/64"	2-7/8"	1-3/4"	10	✓	•	
BC5/32	5/32"	3-1/8"	2"	10	✓	•	•
BC11/64	11/64"	3-1/4"	2-1/8"	10	On Request	•	
BC3/16	3/16"	3-1/2"	2-5/16"	10	✓	•	•
BC13/64	13/64"	3-5/8"	2-7/16"	10	✓	•	
BC7/32	7/32"	3-3/4"	2-1/2"	10	✓	•	•
BC15/64	15/64"	3-7/8"	2-5/8"	10	✓	•	
BC1/4	1/4"	4"	2-3/4"	10	✓	•	•
BC17/64	17/64"	4-1/8"	2-7/8"	5	✓	•	
BC9/32	9/32"	4-1/4"	2-15/16"	5	✓	•	•
BC19/64	19/64"	4-3/8"	3-1/16"	5	✓	•	
BC5/16	5/16"	4-1/2"	3-3/16"	5	✓	•	•
BC21/64	21/64"	4-5/8"	3-5/16"	5	✓	•	
BC11/32	11/32"	4-3/4"	3-7/16"	5	✓	•	•
BC23/64	23/64"	4-7/8"	3-1/2"	5	✓	•	
BC3/8	3/8"	5"	3-5/8"	5	✓	•	•
BC25/64	25/64"	5-1/8"	3-3/4"	5	✓	•	
BC13/32	13/32"	5-1/4"	3-7/8"	5	✓	•	•
BC27/64	27/64"	5-3/8"	3-15/16"	5	✓	•	
BC7/16	7/16"	5-1/2"	4-1/16"	5	✓	•	•
BC29/64	29/64"	5-5/8"	4-3/16"	5	✓	•	
BC15/32	15/32"	5-3/4"	4-5/16"	5	✓	•	•
BC31/64	31/64"	5-7/8"	4-3/8"	5	✓	•	
BC1/2	1/2"	6"	4-1/2"	5	✓	•	•
BC9/16	9/16"	6-5/8"	4-13/16"	1	On Request		
BC5/8	5/8"	7-1/8"	5-3/16"	1	✓		
BC3/4	3/4"	9-31/32"	6-7/64"	1	✓		

CUTTING AND GRINDING TOOLS

**STEEL DRILL BITS**

**COBALT HIGH SPEED STEEL STRAIGHT SHANK DRILL BITS**



•118° and 135° split point tip.

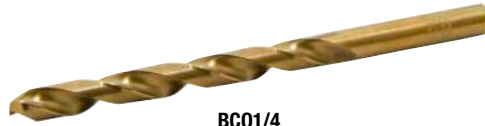

**BC01/4**

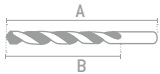

- Manufactured from M35 steel with 5% cobalt.
- Designed for heavy-duty drilling in metals.
- Compatible with all types of drills.
- Not recommended for soft steels.
- High wear resistance.
- Cobalt hardness allows operation at speeds up to 30% higher than conventional high-speed steel bits.



**COBALT HIGH SPEED STEEL STRAIGHT SHANK DRILL BITS SETS**

ITEM	C05129	C05121	C05115
PIECES	29	21	15
PACKING	Display box is supplied when ordering 6 or more sets.	Display box is supplied when ordering 10 or more sets.	Display box is supplied when ordering 8 or more sets.
☞	1	1	1

ITEM	SIZE	TOTAL LENGTH (A)	FLUTE LENGTH (B)	☞	AVAILABLE
BC01/64	1/64"	3/4"	3/16"	10	On Request
BC01/32	1/32"	1-3/8"	1/2"	10	On Request
BC03/64	3/64"	1-3/4"	3/4"	10	On Request
BC01/16	1/16"	1-7/8"	7/8"	10	On Request
BC05/64	5/64"	2"	1"	10	On Request
BC03/32	3/32"	2-1/4"	1-1/4"	10	On Request
BC07/64	7/64"	2-5/8"	1-1/2"	10	On Request
BC01/8	1/8"	2-3/4"	1-5/8"	10	On Request
BC09/64	9/64"	2-7/8"	1-3/4"	10	On Request
BC05/32	5/32"	3-1/8"	2"	10	On Request
BC011/64	11/64"	3-1/4"	2-1/8"	10	On Request
BC03/16	3/16"	3-1/2"	2-5/16"	10	On Request
BC013/64	13/64"	3-5/8"	2-7/16"	10	On Request
BC07/32	7/32"	3-3/4"	2-1/2"	10	On Request
BC015/64	15/64"	3-7/8"	2-5/8"	10	On Request
BC01/4	1/4"	4"	2-3/4"	10	On Request
BC017/64	17/64"	4-1/8"	2-7/8"	5	On Request
BC09/32	9/32"	4-1/4"	3"	5	On Request
BC019/64	19/64"	4-3/8"	3-1/16"	5	On Request
BC05/16	5/16"	4-1/2"	3-3/16"	5	On Request
BC021/64	21/64"	4-5/8"	3-5/16"	5	On Request
BC011/32	11/32"	4-3/4"	3-7/16"	5	On Request
BC023/64	23/64"	4-7/8"	3-1/2"	5	On Request
BC03/8	3/8"	5"	3-5/8"	5	On Request
BC025/64	25/64"	5-1/8"	3-3/4"	5	On Request
BC013/32	13/32"	5-1/4"	3-7/8"	5	On Request
BC027/64	27/64"	5-3/8"	3-15/16"	5	On Request
BC07/16	7/16"	5-1/2"	4-1/16"	5	On Request
BC029/64	29/64"	5-5/8"	4-3/16"	5	On Request
BC015/32	15/32"	5-3/4"	4-5/16"	5	On Request
BC031/64	31/64"	5-7/8"	4-3/8"	5	On Request
BC01/2	1/2"	6"	4-1/2"	5	On Request
BC033/64	33/64"	6-5/8"	4-13/16"	1	On Request
BC017/32	17/32"	6-5/8"	4-13/16"	1	On Request
BC035/64	35/64"	6-5/8"	5-3/16"	1	On Request
BC09/16	9/16"	6-5/8"	5-3/16"	1	On Request
BC037/64	37/64"	6-5/8"	5-3/16"	1	On Request
BC019/32	19/32"	7-1/8"	5-3/16"	1	On Request
BC039/64	39/64"	7-1/8"	5-3/16"	1	On Request
BC05/8	5/8"	7-1/8"	5-3/16"	1	On Request
BC041/64	41/64"	7-1/8"	5-3/16"	1	On Request
BC021/32	21/32"	7-1/8"	5-3/16"	1	On Request
BC043/64	43/64"	7-3/8"	5-3/16"	1	On Request
BC011/16	11/16"	7-5/8"	5-5/8"	1	On Request
BC03/4	3/4"	9-3/4"	5-7/8"	1	On Request

## STEEL DRILL BITS

**PROFESSIONAL USE** INCHES **M2 STEEL**



To drill

Steel	Casting steel	Iron	Bronze	Copper	Brass	Regular steel sheet	Construction rod	Wood	Plastic
-------	---------------	------	--------	--------	-------	---------------------	------------------	------	---------

**SURTEK**  
TOOLS FOR SPECIALISTS



**NEW**

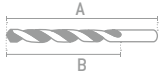

BS11/32



- Manufactured from M2 high-speed steel.
- Cobalt coated.
- Self-centering 135° tip from 1/8" and above.
- Anti-slip shank from 3/16" and above.

ITEM	DRILL BIT SET						
	JBAV29	JBAV21	JBAV17	JBAV13	JBAV10	JBAV7	JBAV5
PIECES	29	21	17	13	10	7	5
PACKING							
	1	1	1	1	1	1	1
AVAILABLE	On Request	On Request	On Request	On Request	On Request	On Request	On Request
BS1/16	•	•	•	•	•	•	•
BS5/64	•	•	•	•	•	•	•
BS3/32	•	•	•	•	•	•	•
BS7/64	•	•	•	•	•	•	•
BS1/8	•	•	•	•	•	•	•
BS9/64	•	•	•	•	•	•	•
BS5/32	•	•	•	•	•	•	•
BS11/64	•	•	•	•	•	•	•
BS3/16	•	•	•	•	•	•	•
BS13/64	•	•	•	•	•	•	•
BS7/32	•	•	•	•	•	•	•
BS15/64	•	•	•	•	•	•	•
BS1/4	•	•	•	•	•	•	•
BS17/64	•	•	•	•	•	•	•
BS9/32	•	•	•	•	•	•	•
BS19/64	•	•	•	•	•	•	•
BS5/16	•	•	•	•	•	•	•
BS21/64	•	•	•	•	•	•	•
BS11/32	•	•	•	•	•	•	•
BS23/64	•	•	•	•	•	•	•
BS3/8	•	•	•	•	•	•	•
BS25/64	•	•	•	•	•	•	•
BS13/32	•	•	•	•	•	•	•
BS27/64	•	•	•	•	•	•	•
BS7/16	•	•	•	•	•	•	•
BS29/64	•	•	•	•	•	•	•
BS15/32	•	•	•	•	•	•	•
BS31/64	•	•	•	•	•	•	•
BS1/2	•	•	•	•	•	•	•
BS5/8	•	•	•	•	•	•	•

CUTTING AND GRINDING TOOLS

## COBALT HIGH SPEED STEEL DRILL BITS WITH STRAIGHT SHANK IN BLISTER

**PROFESSIONAL USE** INCHES **M2 STEEL**



To drill

Steel	Casting steel	Iron	Bronze	Copper	Brass	Regular steel sheet	Construction rod	Wood	Plastic
-------	---------------	------	--------	--------	-------	---------------------	------------------	------	---------

**SURTEK**  
TOOLS FOR SPECIALISTS

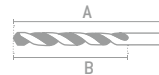

BSB3/16

- Manufactured from M2 steel with 2% cobalt.
- Recommended for use on soft steels.
- Self-centering 135° tip from 1/8" and above.
- Anti-slip shank from 3/16" and above.

ITEM	SIZE	TOTAL LENGTH (A)	FLUTE LENGTH (B)	AVAILABLE	ITEM	SIZE	TOTAL LENGTH (A)	FLUTE LENGTH (B)	AVAILABLE
BSB3/32	3/32"	2-1/4"	1-1/4"	On Request	BSB7/32	7/32"	3-3/4"	2-1/2"	On Request
BSB7/64	7/64"	2-1/2"	1-1/2"	On Request	BSB1/4	1/4"	4"	2-3/4"	On Request
BSB1/8	1/8"	2-3/4"	1-5/8"	On Request	BSB9/32	9/32"	4-1/4"	2-15/16"	On Request
BSB9/64	9/64"	2-3/4"	1-3/4"	On Request	BSB5/16	5/16"	4-1/2"	3-3/16"	On Request
BSB5/32	5/32"	3"	2"	On Request	BSB3/8	3/8"	5"	3-5/8"	On Request
BSB11/64	11/64"	3-1/4"	2-1/8"	On Request	BSB7/16	7/16"	5-1/2"	4-1/16"	On Request
BSB3/16	3/16"	3-1/2"	2-5/16"	On Request	BSB1/2	1/2"	6"	4-1/2"	On Request
BSB13/64	13/64"	3-1/2"	2-7/16"	On Request	BSB5/8	5/8"	7-1/8"	5"	On Request



**STEEL DRILL BITS**

**HIGH-SPEED STEEL COBALT DRILL BITS WITH REDUCED SHANK**



**BSR3/4**

- Manufactured from M2 steel with 2% cobalt.
- Recommended for use on soft steels.
- 1/2" shank.
- 118° tip.

ITEM	SIZE	TOTAL LENGTH (A)	FLUTE LENGTH (B)	⊕	AVAILABLE
BSR9/16	9/16"	6-5/8"	4-13/16"	1	On Request
BSR5/8	5/8"	7-1/8"	5-3/16"	1	On Request
BSR3/4	3/4"	8-1/32"	5-7/8"	1	On Request
BSR7/8	7/8"	8-5/16"	5-7/8"	1	On Request
BSR1	1"	8-9/16"	5-7/8"	1	On Request

**METRIC HIGH-SPEED STEEL COBALT DRILL BITS WITH STRAIGHT SHANK**

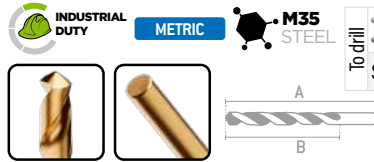

- Manufactured from M35 high-speed steel.
- High cobalt resistance.
- Cobalt hardness allows operating at speeds 30% higher than conventional drill bits.
- 118° tip angle for sizes 1 mm to 2.5 mm.
- 135° tip angle for sizes 3 mm to 13 mm.

ITEM	SIZE	TOTAL LENGTH (A)	FLUTE LENGTH (B)	⊕	AVAILABLE	ITEM	SIZE	TOTAL LENGTH (A)	FLUTE LENGTH (B)	⊕	AVAILABLE
BC10M	1 mm	34 mm	12 mm	10	On Request	BC70M	7 mm	109 mm	69 mm	10	On Request
BC15M	1.5 mm	43 mm	20 mm	10	On Request	BC75M	7.5 mm	109 mm	69 mm	5	On Request
BC20M	2 mm	49 mm	24 mm	10	On Request	BC80M	8 mm	117 mm	75 mm	5	On Request
BC25M	2.5 mm	57 mm	30 mm	10	On Request	BC85M	8.5 mm	117 mm	75 mm	5	On Request
BC30M	3 mm	61 mm	33 mm	10	On Request	BC90M	9 mm	125 mm	81 mm	5	On Request
BC32M	3.2 mm	65 mm	36 mm	10	On Request	BC95M	9.5 mm	125 mm	81 mm	5	On Request
BC35M	3.5 mm	70 mm	39 mm	10	On Request	BC100M	10 mm	133 mm	87 mm	5	On Request
BC40M	4 mm	75 mm	43 mm	10	On Request	BC105M	10.5 mm	133 mm	87 mm	5	On Request
BC45M	4.5 mm	80 mm	47 mm	10	On Request	BC110M	11 mm	142 mm	94 mm	5	On Request
BC50M	5 mm	86 mm	52 mm	10	On Request	BC115M	11.5 mm	142 mm	94 mm	5	On Request
BC52M	5.2 mm	86 mm	52 mm	10	On Request	BC120M	12 mm	151 mm	101 mm	5	On Request
BC55M	5.5 mm	93 mm	57 mm	10	On Request	BC125M	12.5 mm	151 mm	101 mm	5	On Request
BC60M	6 mm	93 mm	57 mm	10	On Request	BC130M	13 mm	151 mm	101 mm	5	On Request
BC65M	6.5 mm	101 mm	63 mm	10	On Request						

**METRIC HIGH-SPEED STEEL COBALT DRILL BITS WITH STRAIGHT SHANK**

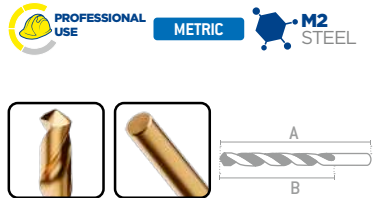

**BS85M**

- Manufactured from M2 steel with 2% cobalt.
- Self-centering 135° tip from 3 mm and above.
- Cobalt coated.

ITEM	SIZE	TOTAL LENGTH (A)	FLUTE LENGTH (B)	⊕	AVAILABLE	ITEM	SIZE	TOTAL LENGTH (A)	FLUTE LENGTH (B)	⊕	AVAILABLE
BS10M	1 mm	34 mm	12 mm	10	On Request	BS70M	7 mm	109 mm	69 mm	10	On Request
BS15M	1.5 mm	43 mm	20 mm	10	On Request	BS75M	7.5 mm	109 mm	69 mm	5	On Request
BS20M	2 mm	49 mm	24 mm	10	On Request	BS80M	8 mm	117 mm	75 mm	5	On Request
BS25M	2.5 mm	57 mm	30 mm	10	On Request	BS85M	8.5 mm	117 mm	75 mm	5	On Request
BS30M	3 mm	61 mm	33 mm	10	On Request	BS90M	9 mm	125 mm	81 mm	5	On Request
BS32M	3.2 mm	65 mm	36 mm	10	On Request	BS95M	9.5 mm	125 mm	81 mm	5	On Request
BS35M	3.5 mm	70 mm	39 mm	10	On Request	BS100M	10 mm	133 mm	87 mm	5	On Request
BS40M	4 mm	75 mm	43 mm	10	On Request	BS105M	10.5 mm	133 mm	87 mm	5	On Request
BS45M	4.5 mm	80 mm	47 mm	10	On Request	BS110M	11 mm	142 mm	94 mm	5	On Request
BS50M	5 mm	86 mm	52 mm	10	On Request	BS115M	11.5 mm	142 mm	94 mm	5	On Request
BS52M	5.2 mm	86 mm	52 mm	10	On Request	BS120M	12 mm	151 mm	101 mm	5	On Request
BS55M	5.5 mm	93 mm	57 mm	10	On Request	BS125M	12.5 mm	151 mm	101 mm	5	On Request
BS60M	6 mm	93 mm	57 mm	10	On Request	BS130M	13 mm	151 mm	101 mm	5	On Request
BS65M	6.5 mm	101 mm	63 mm	10	On Request						

## STEEL DRILL BITS

BLACK OXIDE, HIGH SPEED STEEL DRILL BITS, IN FRACTIONS, ALPHABETICAL AND NUMERICAL SIZES, IN METAL INDEX BOX SET

URREA

### BLACK OXIDE HSS STEEL DRILL BITS

HEAVY DUTY M2 STEEL

115 PIECES COMBINED

To drill													
	Steel	Stainless steel	Iron	Aluminum	Magnesium	Bronze	Copper	Brass	Regular steel sheet	Construction rod	Wood	Acrylic sheet	Plastic

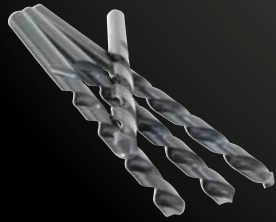

• These drill bits are designed to be used in a wide variety of materials, from soft metals to the strongest. They feature a 118° split point and are heat treated to increase wear resistance. This is the ideal bit for general purpose use in materials with low to medium hardness ratings, in any type of industry.

• Manufactured in high speed steel M2, which due to its characteristics is steel of greater rigidity that increases the life of the cutting edge and favors high production works.

NUMERED					
Content sizes					
1	2	3	4	5	6
7	8	9	10	11	12
13	14	15	16	17	18
19	20	21	22	23	24
25	26	27	28	29	30
31	32	33	34	35	36
37	38	39	40	41	42
43	44	45	46	47	48
49	50	51	52	53	54
55	56	57	58	59	60

ALPHABETICAL				
Content sizes				
A	B	C	D	E
F	G	H	I	J
K	L	M	N	O
P	Q	R	S	T
U	V	W	X	Y
Z				

FRACTIONAL				
Content sizes				
1/16"	5/64"	3/32"	7/64"	1/8"
9/64"	5/32"	11/64"	3/16"	13/64"
7/32"	15/64"	1/4"	17/64"	9/32"
19/64"	5/16"	21/64"	11/32"	23/64"
3/8"	25/64"	13/32"	27/64"	7/16"
29/64"	15/32"	31/64"	1/2"	

ITEM	PIECES	AVAILABLE
51115	115	1 ✓

### HIGH SPEED STEEL STRAIGHT SHANK BLACK DRILL BITS

HEAVY DUTY FRACTIONAL M2 STEEL

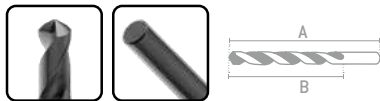

- Manufactured from M1 high-speed steel.
- 118° tip angle and treated surface for increased wear resistance.
- For drilling aluminum, copper, brass, zinc, iron, and unalloyed steel.

FRACTIONAL DRILL BIT SETS				
ITEM	5129	5121	5115	5113
PIECES	29	21	15	13
PACKING				
BOX	4079	4078	4077	
AVAILABLE	1 ✓	1 ✓	1 ✓	1 On Request

CUTTING AND GRINDING TOOLS

ITEM	SIZE	TOTAL LENGTH (A)	FLUTE LENGTH (B)	AVAILABLE
B1/64	1/64"	3/4"	3/16"	10 ✓
B1/32	1/32"	1-3/8"	1/2"	10 ✓
B3/64	3/64"	1-3/4"	3/4"	10 ✓
B1/16	1/16"	1-7/8"	7/8"	10 ✓
B5/64	5/64"	2"	1"	10 ✓
B3/32	3/32"	2-1/4"	1-1/4"	10 ✓
B7/64	7/64"	2-5/8"	1-1/2"	10 ✓
B1/8	1/8"	2-3/4"	1-5/8"	10 ✓
B9/64	9/64"	2-7/8"	1-3/4"	10 ✓
B5/32	5/32"	3-1/8"	2"	10 ✓
B11/64	11/64"	3-1/4"	2-1/8"	10 ✓
B3/16	3/16"	3-1/2"	2-5/16"	10 ✓
B13/64	13/64"	3-5/8"	2-7/16"	10 ✓
B7/32	7/32"	3-3/4"	2-1/2"	10 ✓
B15/64	15/64"	3-7/8"	2-5/8"	10 ✓
B1/4	1/4"	4"	2-3/4"	10 ✓
B17/64	17/64"	4-1/8"	2-7/8"	10 ✓
B9/32	9/32"	4-1/4"	3"	10 ✓
B19/64	19/64"	4-3/8"	3-1/16"	5 ✓
B5/16	5/16"	4-1/2"	3-3/16"	5 ✓
B21/64	21/64"	4-5/8"	3-5/16"	5 ✓
B11/32	11/32"	4-3/4"	3-7/16"	5 ✓
B23/64	23/64"	4-7/8"	3-1/2"	5 ✓
B3/8	3/8"	5"	3-5/8"	5 On Request
B25/64	25/64"	5-1/8"	3-3/4"	5 ✓
B13/32	13/32"	5-1/4"	3-7/8"	5 ✓
B27/64	27/64"	5-3/8"	3-15/16"	5 ✓
B7/16	7/16"	5-1/2"	4-1/16"	5 ✓
B29/64	29/64"	5-5/8"	4-3/16"	5 ✓
B15/32	15/32"	5-3/4"	4-5/16"	5 ✓
B31/64	31/64"	5-7/8"	4-3/8"	5 ✓
B1/2	1/2"	6"	4-1/2"	5 On Request
B17/32	17/32"	6-5/8"	4-13/16"	1 On Request
B9/16	9/16"	6-5/8"	4-13/16"	1 ✓
B19/32	19/32"	7-1/8"	5-3/16"	1 ✓
B5/8	5/8"	7-1/8"	5-3/16"	1 ✓
B21/32	21/32"	7-1/8"	5-3/16"	1 ✓
B11/16	11/16"	7-5/8"	5-5/8"	1 ✓
B3/4	3/4"	9-3/4"	5-7/8"	1 ✓

**STEEL DRILL BITS**

**HIGH SPEED STEEL STRAIGHT SHANK BLACK DRILL BITS**



INCHES



URREA



**BG1/4**

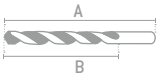

- Manufactured from M1 high-speed steel.
- 118° tip angle and treated surface for increased wear resistance.
- For drilling aluminum, copper, brass, zinc, iron, and unalloyed steel.



**BLACK OXIDE HIGH SPEED DRILL BIT SETS**

ITEM	G5129	G5121	G5115
PIECES	29	21	15
PACKING	Display box is supplied when ordering 6 or more sets.	Display box is supplied when ordering 10 or more sets.	Display box is supplied when ordering 8 or more sets.
	1	1	1
AVAILABLE	On Request	On Request	On Request
BG1/64			
BG1/32			
BG3/64			
BG1/16			
BG5/64			
BG3/32			
BG7/64			
BG1/8			
BG9/64			
BG5/32			
BG11/64			
BG3/16			
BG13/64			
BG7/32			
BG15/64			
BG1/4			
BG17/64			
BG9/32			
BG19/64			
BG5/16			
BG21/64			
BG11/32			
BG23/64			
BG3/8			
BG25/64			
BG13/32			
BG27/64			
BG7/16			
BG29/64			
BG15/32			
BG31/64			
BG1/2			
BG33/64			
BG17/32			
BG35/64			
BG9/16			
BG37/64			
BG19/32			
BG39/64			
BG5/8			
BG41/64			
BG21/32			
BG43/64			
BG11/16			
BG3/4			

CUTTING AND GRINDING TOOLS

## STEEL DRILL BITS

### HIGH SPEED STEEL STRAIGHT SHANK BLACK DRILL BITS IN BLISTER



BGB3/4

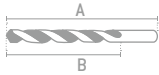

- Manufactured from M2 high-speed steel.
- 135° tip angle.
- For drilling aluminum, copper, brass, zinc, iron, and unalloyed steel.
- Two-flute design ensures smoother holes.

ITEM	SIZE	TOTAL LENGTH	FLUTE LENGTH	⊕	AVAILABLE	ITEM	SIZE	TOTAL LENGTH	FLUTE LENGTH	⊕	AVAILABLE
BGB3/32	3/32"	2-1/4" / 57 mm	1-1/4" / 32 mm	1	On Request	BGB1/4	1/4"	4" / 102 mm	2-3/4" / 70 mm	1	On Request
BGB7/64	7/64"	2-5/8" / 67 mm	1-1/2" / 38 mm	1	On Request	BGB9/32	9/32"	4-1/4" / 108 mm	3" / 76 mm	1	On Request
BGB1/8	1/8"	2-3/4" / 70 mm	1-5/8" / 41 mm	1	On Request	BGB5/16	5/16"	4-1/2" / 114 mm	3-3/16" / 81 mm	1	On Request
BGB9/64	9/64"	2-7/8" / 73 mm	1-3/4" / 44 mm	1	On Request	BGB3/8	3/8"	5" / 127 mm	3-5/8" / 92 mm	1	On Request
BGB5/32	5/32"	3-1/8" / 79 mm	2" / 51 mm	1	On Request	BGB7/16	7/16"	5-1/2" / 140 mm	4-1/16" / 103 mm	1	On Request
BGB11/64	11/64"	3-1/4" / 83 mm	2-1/8" / 54 mm	1	On Request	BGB1/2	1/2"	6" / 152 mm	4-1/2" / 114 mm	1	On Request
BGB3/16	3/16"	3-1/2" / 89 mm	2-5/16" / 59 mm	1	On Request	BGB9/16	9/16"	6-5/8" / 168 mm	4-13/16" / 122 mm	1	On Request
BGB13/64	13/64"	3-5/8" / 92 mm	2-7/16" / 62 mm	1	On Request	BGB5/8	5/8"	7-1/8" / 181 mm	5-3/16" / 132 mm	1	On Request
BGB7/32	7/32"	3-3/4" / 95 mm	2-1/2" / 64 mm	1	On Request	BGB3/4	3/4"	9-3/4" / 247 mm	5-7/8" / 149 mm	1	On Request

### BLACK HIGH-SPEED STEEL DRILL BITS WITH STRAIGHT SHANK



BAVN1/4

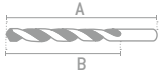

- Manufactured from M2 high-speed steel.
- 118° tip.
- For drilling aluminum, copper, brass, zinc, iron, and unalloyed steel.

ITEM	SIZE	TOTAL LENGTH (A)	FLUTE LENGTH (B)	⊕	AVAILABLE	DRILL BIT SET
BAVN1/16	1/16"	2"	7/8"	10	On Request	JBAVN29
-	5/64"		Not available for individual sale			29
BAVN3/32	3/32"	2-1/4"	1-1/4"	10	On Request	
BAVN7/64	7/64"	2-1/2"	1-1/2"	10	On Request	
BAVN1/8	1/8"	2-3/4"	1-5/8"	10	On Request	
BAVN9/64	9/64"	2-3/4"	1-3/4"	10	On Request	
BAVN5/32	5/32"	3"	2"	10	On Request	
BAVN11/64	11/64"	3-1/4"	2-1/8"	10	On Request	
BAVN3/16	3/16"	3-1/2"	2-5/16"	10	On Request	
BAVN13/64	13/64"	3-1/2"	2-7/16"	10	On Request	
BAVN7/32	7/32"	3-3/4"	2-1/2"	10	On Request	
BAVN15/64	15/64"	3-3/4"	2-5/8"	10	On Request	
BAVN1/4	1/4"	4"	2-3/4"	10	On Request	
BAVN17/64	17/64"	4"	2-7/8"	10	On Request	
BAVN9/32	9/32"	4-1/4"	2-15/16"	10	On Request	
-	19/64"		Not available for individual sale			
BAVN5/16	5/16"	4-1/2"	3-3/16"	5	On Request	
-	21/64"		Not available for individual sale			
BAVN11/32	11/32"	4-3/4"	3-7/16"	5	On Request	
-	23/64"		Not available for individual sale			
BAVN3/8	3/8"	5"	3-5/8"	5	On Request	
-	25/64"		Not available for individual sale			
BAVN13/32	13/32"	5-1/4"	3-7/8"	5	On Request	
-	27/64"		Not available for individual sale			
BAVN7/16	7/16"	5-1/2"	4-1/16"	5	On Request	
-	29/64"		Not available for individual sale			
BAVN15/32	15/32"	5-3/4"	4-5/16"	5	On Request	
-	31/64"		Not available for individual sale			
BAVN1/2	1/2"	6"	4-1/2"	5	On Request	

**STEEL DRILL BITS**

**HIGH-SPEED STEEL DRILL BITS WITH REDUCED SHANK**



**BSD1-1/16**

- Manufactured from M2 high-speed steel.
- 118° tip.
- 1/2" shank.

ITEM	SIZE	⌀	AVAILABLE
BSD1-1/16	1-1/16"	1	On Request
BSD1-1/8	1-1/8"	1	On Request
BSD1-1/4	1-1/4"	1	On Request
BSD1-5/16	1-5/16"	1	On Request
BSD1-1/2	1-1/2"	1	On Request



**HIGH SPEED STEEL STRAIGHT SHANK BLACK DRILL BITS**



**B30MM**

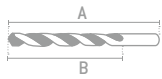

ITEM	SIZE	TOTAL LENGTH (A)	FLUTE LENGTH (B)	⌀	AVAILABLE
B10MM	1.0 mm	1-7/8"	7/8"	10	On Request
B11MM	1.1 mm	1-7/8"	7/8"	10	On Request
B12MM	1.2 mm	1-7/8"	7/8"	10	On Request
B13MM	1.3 mm	1-7/8"	7/8"	10	On Request
B14MM	1.4 mm	1-7/8"	7/8"	10	On Request
B15MM	1.5 mm	1-7/8"	7/8"	10	On Request
B16MM	1.6 mm	1-7/8"	7/8"	10	On Request
B17MM	1.7 mm	2"	1"	10	On Request
B18MM	1.8 mm	2"	1"	10	On Request
B19MM	1.9 mm	2"	1"	10	On Request
B20MM	2.0 mm	2"	1"	10	On Request
B25MM	2.5 mm	2-3/8"	1-7/16"	10	On Request
B30MM	3.0 mm	3-3/4"	1-11/16"	10	On Request
B35MM	3.5 mm	2-7/8"	1-13/16"	10	On Request
B40MM	4.0 mm	3-1/4"	2-3/16"	10	On Request
B45MM	4.5 mm	3-3/8"	2-1/4"	10	On Request
B50MM	5.0 mm	3-5/8"	2-1/2"	10	On Request

ITEM	SIZE	TOTAL LENGTH (A)	FLUTE LENGTH (B)	⌀	AVAILABLE
B55MM	5.5 mm	3-13/16"	2-9/16"	10	On Request
B60MM	6.0 mm	4-1/16"	2-13/16"	10	On Request
B65MM	6.5 mm	4-3/16"	2-15/16"	10	✓
B70MM	7.0 mm	4-3/16"	2-15/16"	10	✓
B75MM	7.5 mm	4-7/16"	3-1/8"	5	On Request
B80MM	8.0 mm	4-9/16"	3-1/4"	5	✓
B85MM	8.5 mm	4-13/16"	3-1/2"	5	On Request
B90MM	9.0 mm	5"	3-9/16"	5	✓
B95MM	9.5 mm	5-1/16"	3-11/16"	5	On Request
B100MM	10.0 mm	5-5/16"	3-13/16"	5	✓
B105MM	10.5 mm	5-3/8"	3-15/16"	5	On Request
B110MM	11.0 mm	5-5/8"	4-1/8"	5	On Request
B115MM	11.5 mm	5-3/4"	4-1/4"	5	On Request
B120MM	12.0 mm	6"	4-7/16"	5	✓
B125MM	12.5 mm	6"	4-9/16"	5	On Request
B130MM	13.0 mm	6"	4-9/16"	5	✓

**HIGH SPEED STEEL STRAIGHT SHANK BLACK DRILL BITS**



**BLTS**

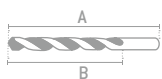

ITEM	SIZE	mm	in	TOTAL LENGTH (A)	FLUTE LENGTH (B)	⌀	AVAILABLE
BLTA	A	5.94	0.234	3-7/8"	2-5/8"	10	✓
BLTB	B	6.05	0.238	4"	2-3/4"	10	On Request
BLTC	C	6.15	0.242	4"	2-3/4"	10	On Request
BLTD	D	6.25	0.246	4"	2-3/4"	10	On Request
BLTE	E	6.35	0.25	4"	2-3/4"	10	On Request
BLTF	F	6.53	0.257	4-1/8"	2-7/8"	10	✓
BLTG	G	6.63	0.261	4-1/8"	2-2/8"	10	On Request
BLTH	H	6.76	0.266	4-1/8"	2-7/8"	10	✓
BLTI	I	6.91	0.272	4-1/8"	2-7/8"	10	✓
BLTJ	J	7.04	0.277	4-1/8"	2-7/8"	10	On Request
BLTK	K	7.14	0.281	4-1/4"	2-15/16"	10	✓
BLTL	L	7.37	0.29	4-1/4"	2-15/16"	5	On Request
BLTM	M	7.49	0.295	4-3/8"	3-1/16"	5	On Request

ITEM	SIZE	mm	in	TOTAL LENGTH (A)	FLUTE LENGTH (B)	⌀	AVAILABLE
BLTN	N	7.57	0.302	4-3/8"	3-1/16"	5	On Request
BLTO	O	8.07	0.316	4-1/2"	3-3/16"	5	On Request
BLTP	P	8.2	0.323	4-5/8"	3-5/16"	5	On Request
BLTQ	Q	8.43	0.332	3-7/16"	3-7/16"	5	✓
BLTR	R	8.61	0.339	4-3/4"	3-7/16"	5	On Request
BLTS	S	8.84	0.348	4-7/8"	3-1/2"	5	On Request
BLTU	U	9.35	0.368	5"	3-5/8"	5	✓
BLTV	V	9.56	0.377	5"	3-5/8"	5	On Request
BLTW	W	9.8	0.386	5-1/8"	3-3/4"	5	On Request
BLTX	X	10.08	0.397	5-1/8"	3-3/4"	5	On Request
BLTY	Y	10.26	0.404	5-1/4"	3-7/8"	5	On Request
BLTZ	Z	10.49	0.413	5-1/4"	3-7/8"	5	On Request

## STEEL DRILL BITS

### HIGH SPEED STEEL STRAIGHT SHANK BLACK DRILL BITS



**BNM13**



NUMBERED DRILL BIT SET	
ITEM	5160
PIECES	60
PACKING	
AVAILABLE	1

ITEM	SIZE	mm	in	TOTAL LENGTH (A)	FLUTE LENGTH (B)	AVAILABLE
BNM80	No. 80	0.34	0.0135	3/4"	1/8"	10 ✓
BNM79	No. 79	0.37	0.0145	3/4"	1/8"	10 ✓
BNM78	No. 78	0.41	0.0160	7/8"	3/16"	10 ✓
BNM77	No. 77	0.46	0.0180	7/8"	3/16"	10 ✓
BNM76	No. 76	0.51	0.0200	7/8"	3/16"	10 ✓
BNM75	No. 75	0.53	0.2100	1"	1/4"	10 ✓
BNM74	No. 74	0.57	0.0225	1"	1/4"	10 ✓
BNM72	No. 72	0.64	0.0250	1-1/18"	5/16"	10 ✓
BNM71	No. 71	0.66	0.0260	1-1/4"	3/8"	10 ✓
BNM70	No. 70	0.71	0.0280	1-1/4"	3/8"	10 ✓
BNM69	No. 69	0.74	0.0292	1-3/4"	1/2"	10 ✓
BNM68	No. 68	0.79	0.0310	1-3/4"	1/2"	10 ✓
BNM67	No. 67	0.81	0.0320	1-3/4"	1/2"	10 ✓
BNM66	No. 66	0.84	0.0330	1-3/4"	1/2"	10 On Request
BNM65	No. 65	0.89	0.0350	1-1/2"	5/8"	10 ✓
BNM64	No. 64	0.91	0.0360	1-1/2"	5/8"	10 ✓
BNM63	No. 63	0.94	0.0370	5/8"	5/8"	10 ✓
BNM62	No. 62	0.97	0.0380	5/8"	5/8"	10 ✓
BNM61	No. 61	0.99	0.0390	1-5/8"	11/16"	10 ✓
BNM60	No. 60	1.02	0.0400	1-5/8"	11/16"	10 On Request
BNM59	No. 59	1.04	0.0410	1-5/8"	11/16"	10 ✓
BNM58	No. 58	1.07	0.0420	1-5/8"	11/16"	10 ✓
BNM57	No. 57	1.09	0.0430	1-3/4"	3/4"	10 ✓
BNM56	No. 56	1.18	0.0465	1-3/4"	3/4"	10 On Request
BNM55	No. 55	1.32	0.0520	1-7/8"	7/8"	10 ✓
BNM54	No. 54	1.40	0.0550	1-7/8"	7/8"	10 ✓
BNM53	No. 53	1.51	0.0595	1-7/8"	7/8"	10 On Request
BNM52	No. 52	1.61	0.0635	1-7/8"	7/8"	10 On Request
BNM51	No. 51	1.70	0.0670	2"	1"	10 ✓
BNM50	No. 50	1.78	0.0700	2"	1"	10 ✓
BNM49	No. 49	1.85	0.0730	2"	1"	10 ✓
BNM48	No. 48	1.93	0.0760	2"	1"	10 ✓
BNM47	No. 47	1.99	0.0785	2"	1"	10 ✓
BNM46	No. 46	2.06	0.0810	2-1/8"	1-1/8"	10 ✓
BNM45	No. 45	2.08	0.0820	2-1/8"	1-1/8"	10 ✓
BNM44	No. 44	2.18	0.0860	2-1/8"	1-1/8"	10 ✓
BNM43	No. 43	2.26	0.0890	2-1/4"	1-1/4"	10 ✓
BNM42	No. 42	2.37	0.0935	2-1/4"	1-1/4"	10 ✓
BNM41	No. 41	2.44	0.0960	2-3/8"	1-3/8"	10 ✓
BNM40	No. 40	2.50	0.0980	2-3/8"	1-3/8"	10 ✓
BNM39	No. 39	2.53	0.0995	2-3/8"	1-3/8"	10 ✓
BNM38	No. 38	2.58	0.1015	2-1/2"	1-7/16"	10 ✓
BNM37	No. 37	2.64	0.1040	2-1/2"	1-7/16"	10 ✓
BNM36	No. 36	2.71	0.1065	2-1/2"	1-7/16"	10 ✓
BNM35	No. 35	2.79	0.1100	2-5/8"	1-1/2"	10 ✓
BNM34	No. 34	2.82	0.1110	2-5/8"	1-1/2"	10 ✓
BNM33	No. 33	2.87	0.1130	2-5/8"	1-1/2"	10 ✓
BNM32	No. 32	2.95	0.1160	2-3/4"	1-5/8"	10 ✓
BNM31	No. 31	3.05	0.1200	2-3/4"	1-5/8"	10 ✓
BNM30	No. 30	3.26	0.1285	2-3/4"	1-5/8"	10 ✓
BNM29	No. 29	3.45	0.1360	2-7/8"	1-3/4"	10 ✓
BNM28	No. 28	3.57	0.1405	2-7/8"	1-3/4"	10 ✓
BNM27	No. 27	3.66	0.1440	3"	1-7/8"	10 On Request
BNM26	No. 26	3.73	0.1470	3"	1-7/8"	10 ✓
BNM25	No. 25	3.80	0.1495	3"	1-7/8"	10 On Request
BNM24	No. 24	3.86	0.1520	3-1/8"	2"	10 ✓
BNM23	No. 23	3.91	0.1540	3-1/8"	2"	10 ✓
BNM22	No. 22	3.99	0.1570	3-1/8"	2"	10 ✓
BNM21	No. 21	4.04	0.1590	3-1/4"	2-1/8"	10 ✓
BNM19	No. 19	4.22	0.1660	3-1/4"	2-1/8"	10 ✓
BNM18	No. 18	4.31	0.1695	3-1/4"	2-1/8"	10 ✓
BNM17	No. 17	4.39	0.1730	3-3/8"	2-3/16"	10 ✓
-	No. 16	4.50	0.1770	3-3/8"	2-3/16"	10 Not available for individual sale
BNM15	No. 15	4.57	0.1800	3-3/8"	2-3/16"	10 ✓
BNM14	No. 14	4.62	0.1820	3-3/8"	2-3/16"	10 ✓
BNM13	No. 13	4.70	0.1850	3-1/2"	2-5/16"	10 ✓
BNM12	No. 12	4.80	0.1890	3-1/2"	2-5/16"	10 ✓
BNM11	No. 11	4.85	0.1910	3-1/2"	2-5/16"	10 On Request
BNM10	No. 10	4.91	0.1935	3-5/8"	2-7/16"	10 ✓
BNM9	No. 9	4.98	0.1960	3-5/8"	2-7/16"	10 ✓
BNM8	No. 8	5.05	0.1990	3-5/8"	2-7/16"	10 ✓
BNM7	No. 7	5.11	0.2100	3-5/8"	2-7/16"	10 ✓
BNM6	No. 6	5.18	0.2040	3-3/4"	2-1/2"	10 ✓
BNM5	No. 5	5.22	0.2055	3-3/4"	2-1/2"	10 ✓
BNM4	No. 4	5.31	0.2090	3-3/4"	2-1/2"	10 ✓
-	No. 3	5.41	0.2130	3-3/4"	2-1/2"	10 Not available for individual sale
BNM2	No. 2	5.61	0.2210	3-7/8"	2-5/8"	10 ✓
BNM1	No. 1	5.79	0.2280	3-7/8"	2-5/8"	10 ✓

CUTTING AND GRINDING TOOLS

STEEL DRILL BITS

HIGH SPEED STEEL LONG SHANK BLACK DRILL BITS

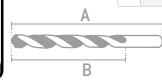

• Ideal for use in construction, aviation, and transportation, as the long shank allows drilling in hard-to-reach areas.



BZL1/4

ITEM	SIZE	TOTAL LENGTH (A)	FLUTE LENGTH (B)	⊞ AVAILABLE
BZL1/8	1/8"	12"	1-5/8"	1 On Request
BZL5/32	5/32"	12"	2-5/16"	1 On Request
BZL3/16	3/16"	12"	2-1/2"	1 On Request
BZL7/32	7/32"	12"	2-3/4"	1 On Request
BZL1/4	1/4"	12"	2-15/16"	1 ✓
BZL9/32	9/32"	12"	3-3/16"	1 On Request
BZL5/16	5/16"	12"	3-7/16"	1 On Request

ITEM	SIZE	TOTAL LENGTH (A)	FLUTE LENGTH (B)	⊞ AVAILABLE
BZL11/32	11/32"	12"	3-5/8"	1 On Request
BZL3/8	3/8"	12"	3-7/8"	1 On Request
BZL13/32	13/32"	12"	3-7/8"	1 On Request
BZL7/16	7/16"	12"	4-1/16"	1 On Request
BZL15/32	15/32"	12"	4-5/16"	1 On Request
BZL1/2	1/2"	12"	4-1/2"	1 On Request

MORSE TAPER SHANK DRILL BITS

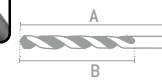
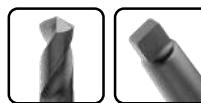

• 118-degree angle



BZC1

• Tapered shank provides strong grip and prevents slipping, ensuring precise drilling from 1/2" diameter and above.  
 • Compatible with stationary drills, lathes, and CNC machines; ideal for low to medium hardness materials.

ITEM	SIZE	TIP SIZE	TOTAL LENGTH (A)	FLUTE LENGTH (B)	⊞ AVAILABLE
BZC5/8	5/8"	2	8-3/4"	4-7/8"	1 On Request
BZC3/4	3/4"	2	9-3/4"	5-7/8"	1 On Request
BZC13/16	13/16"	3	10-3/4"	6-1/8"	1 On Request
BZC7/8	7/8"	3	10-3/4"	6-1/8"	1 On Request
BZC15/16	15/16"	3	10-3/4"	6-1/8"	1 On Request
BZC1	1"	3	11"	6-3/8"	1 On Request
BZC1-1/8	1-1/8"	4	12-3/4"	7-1/8"	1 On Request

ITEM	SIZE	TIP SIZE	TOTAL LENGTH (A)	FLUTE LENGTH (B)	⊞ AVAILABLE
BZC1-1/4	1-1/4"	4	13-1/2"	7-7/8"	1 On Request
BZC1-3/8	1-3/8"	4	14-1/2"	8-7/8"	1 On Request
BZC1-7/16	1-7/16"	4	14-3/4"	9-1/8"	1 On Request
BZC1-1/2	1-1/2"	4	15"	9-3/8"	1 On Request
BZC1-11/16	1-11/16"	5	17-1/8"	10-1/8"	1 On Request
BZC1-13/16	1-13/16"	5	17-1/8"	10-1/8"	1 On Request
BZC1-7/8	1-7/8"	5	17-3/8"	10-3/8"	1 On Request

3-FLAT SHANK STEP DRILL BITS



NEW



BME4

• Manufactured from M2 steel with high wear and heat resistance.  
 • Double-flute construction.  
 • Special surface treatment.  
 • Three-flat shank for stronger grip.

ITEM	SIZE	STEPS	HEX SHANK	⊞ AVAILABLE	DRILL BIT SET	
					ITEM	PIECES
BME1	1/8" to 1/2"	13	1/4"	1 On Request	JBM3	3
BME2	3/16" to 1/2"	6	1/4"	1 On Request		
BME3	3/16" to 7/8"	12	1/4"	1 On Request		
BME4	1/4" to 3/4"	9	3/8"	1 On Request		
BME5	9/16" to 1"	8	3/8"	1 On Request		
BME6	13/16" to 1-3/8"	10	3/8"	1 On Request		
BME7	1/4" to 1-3/8"	10	1/2"	1 On Request		

3-FLAT SHANK STEP DRILL BITS WITH



NEW



119373

• Manufactured from high-speed steel.  
 • Double-flute construction.  
 • Special surface treatment.  
 • Three-flat shank for stronger grip.

ITEM	SIZE	STEPS	HEX SHANK	⊞ AVAILABLE	DRILL BIT SET	
					ITEM	PIECES
119370	1/8" to 1/2"	13	1/4"	1 On Request	JBE3	3
119372	1/4" to 3/4"	9	3/8"	1 On Request		
119373	3/16" to 7/8"	12	3/8"	1 On Request		
119374	1/4" to 1 to 3/8"	10	1/2"	1 On Request		

## STEEL DRILL BITS

### 5-FLUTE COUNTERSINKS

PROFESSIONAL USE

INCHES

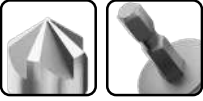

119375

- Designed for flat head countersunk screws.
- High performance in chamfering, countersinking, and deburring operations.
- 1/4" hex shank.
- 82° angle.

ITEM	SIZE	AVAILABILITY
119375	1/2"	On Request
119376	5/8"	On Request
119377	3/4"	On Request

SURTEK TOOLS FOR SPECIALISTS



NEW

### CENTER DRILL AND COUNTERSINK BITS

HEAVY DUTY

INCHES



URREA TOOLS FOR PROFESSIONALS



- High-speed steel construction for superior performance.
- 118° tip for accurate starts in stainless steel, cast iron, bronze, and copper.
- Spiral flute design improves hole quality and extends tool life.
- Bell-type tip drills and countersinks simultaneously, leaving burr-free holes.
- Right-hand helix ensures efficient chip removal.

ITEM	SIZE	DIAMETER		AVAILABILITY
		BODY (A)	LENGTH (B)	
BCEN1	No. 1	1/8"	3/64"	On Request
BCEN2	No. 2	3/16"	5/64"	✓
BCEN3	No. 3	1/4"	7/64"	On Request
BCEN4	No. 4	5/16"	1/8"	✓
BCEN5	No. 5	7/16"	3/16"	On Request
BCEN6	No. 6	1/2"	7/32"	On Request
BCEN7	No. 7	5/8"	1/4"	On Request
BCEN8	No. 8	3/4"	5/16"	On Request

## GLASS AND TILE DRILL BITS

### GLASS AND TILE DRILL BITS - STEEL BODY WITH TUNGSTEN CARBIDE TIP

INDUSTRIAL DUTY

INCHES



URREA TOOLS FOR PROFESSIONALS

NEW



BVU18

- Drill bits with tungsten carbide tip.
- Spiral body for easy chip removal.
- Arrowhead tip for smoother drilling.
- Three-flat shank prevents slipping.

ITEM	SIZE	TOTAL LENGTH	AVAILABILITY	DRILL BIT SET	
				ITEM	PIECES
BVU18	1/8"	2-1/2"	On Request	JBVU4	4
BVU316	3/16"	3"	On Request		•
BVU14	1/4"	3-1/5"	On Request		•
BVU516	5/16"	3-1/3"	On Request		•
BVU38	3/8"	3-2/3"	On Request		•
BVU12	1/2"	4-1/3"	On Request		•

### GLASS AND TILE DRILL BITS - STEEL BODY WITH TUNGSTEN CARBIDE TIP

PROFESSIONAL USE

INCHES



SURTEK TOOLS FOR SPECIALISTS

NEW



BVS18

- Drill bits with tungsten carbide tip.
- Arrowhead tip for smoother drilling.

ITEM	SIZE	TOTAL LENGTH	AVAILABILITY	DRILL BIT SET	
				ITEM	PIECES
BVS18	1/8"	2-1/2"	On Request	JBVS4	4
BVS316	3/16"	3"	On Request		•
BVS14	1/4"	3-1/5"	On Request		•
BVS516	5/16"	3-1/3"	On Request		•
BVS38	3/8"	3-2/3"	On Request		•
BVS12	1/2"	4-1/3"	On Request		•

CUTTING AND GRINDING TOOLS

## LATHE TOOL BITS

### LATHE TOOL BITS

SUPER DUTY



90632

- High-speed steel lathe tools for mild steel, aluminum, bronze, and copper.
- Cobalt enhances hardness and cutting performance.
- Square tools ideal for heavy-duty cuts and deeper machining.
- Compatible with lathes, profiling machines, and shapers.

ITEM	SQUARE	TOTAL LENGTH	AVAILABILITY
90616	1/4"	2-1/2"	On Request
90624	3/8"	3"	On Request
90632	1/2"	4"	On Request

URREA TOOLS FOR PROFESSIONALS



## HAND BRACE

### HAND BRACE WITH RATCHET

PROFESSIONAL USE



BCM10

MBR

- Wide-jaw chuck and sleeve.
- Ratchet gear system.
- Wooden rotating handles.

GRANEL

BULK

ITEM	SIZE	AVAILABILITY
BCM10	12"	On Request

### Replacement

ITEM	DESCRIPTION	AVAILABILITY
MBR	Jaw set for item BCM10	On Request



WIRE CUP BRUSHES

TWISTED WIRE CUP BRUSHES



- High-strength carbon steel twisted wire.
- Heavy-duty design for demanding applications.
- Suitable for high-speed operation.
- Ideal for large surface work.
- High material removal capacity.
- Excellent wear resistance.
- Perfect for cleaning metal plates, frames, rust, paint, and general residues.
- For use with angle grinders.



ITEM	DIAMETER	THREAD	WIRE GAUGE	MAX SPEED	☑	AVAILABLE
<b>Thin wire</b>						
C800	3"	5/8"	0.014"	12500	1	On Request
C801	3"	14mm	0.014"	12500	1	On Request
C802	4"	5/8"	0.014"	8500	1	On Request
<b>Thick wire</b>						
C803	4"	14mm	0.014"	8500	1	On Request
C806	3"	5/8"	0.020"	12500	1	On Request
C807	3"	14mm	0.020"	12500	1	On Request
C808	4"	5/8"	0.020"	8500	1	On Request
C809	4"	14mm	0.020"	8500	1	On Request
C810	5"	5/8"	0.020"	6500	1	On Request
18CT55M	5"	14mm	0.020"	6500	1	On Request
C811	5"	14mm	0.020"	6500	1	On Request

TWISTED CUP BRUSHES WITH CARBON STEEL WITH SHANK



- High-strength carbon steel twisted wire.
- Suitable for high-speed operation.
- Ideal for cleaning in hard-to-reach areas.
- High material removal capacity.
- Excellent wear resistance.
- For heavy-duty jobs such as cleaning metal plates, frames, rust, paint, and general residues.
- For use with angle grinders.



ITEM	DIAMETER	THREAD	WIRE GAUGE	MAX SPEED	☑	AVAILABLE
<b>Thin wire</b>						
C837	1-1/8"	1/4"	0.014"	20000	1	On Request
<b>Thick wire</b>						
C839	1-1/8"	1/4"	0.020"	20000	1	On Request

STAINLESS STEEL TWISTED CUP BRUSHES



- Stainless steel twisted wire.
- Suitable for high-speed operation.
- Ideal for cleaning in hard-to-reach areas.
- High material removal capacity.
- Excellent corrosion resistance, suitable for humid or aggressive environments.
- For heavy-duty jobs such as cleaning metal plates, frames, rust, paint, and general residues.
- For use with angle grinders.



ITEM	DIAMETER	THREAD	WIRE GAUGE	MAX SPEED	☑	AVAILABLE
<b>Thin wire</b>						
C920	3"	5/8"	0.014"	12500	1	On Request
C921	3"	14 mm	0.014"	12500	1	On Request
<b>Thick wire</b>						
C926	3"	5/8"	0.020"	12500	1	On Request
C927	3"	14 mm	0.020"	12500	1	On Request
C928	4"	5/8"	0.020"	8500	1	On Request
C929	4"	14 mm	0.020"	8500	1	On Request

TWISTED WIRE CUP BRUSHES



Item	Diameter	Replace to
C512	3"	123236
C513	3"	123237
C514	4"	123238
C515	4"	123239
C516	5"	123240
C517	5"	123241
C523	5"	123242
C524	5"	123243



C512 Thin wire

- Carbon steel twisted wire.
- Ideal for large surface work.
- High material removal capacity.
- For use with angle grinders.



ITEM	DIAMETER	THREAD	WIRE GAUGE	MAX SPEED	☑	AVAILABLE
<b>Thin wire</b>						
C512	3"	5/8"	0.014"	12500	1	On Request
C513	3"	14 mm	0.014"	12500	1	On Request
C514	4"	5/8"	0.014"	8500	1	On Request
C515	4"	14 mm	0.014"	8500	1	On Request
C516	5"	5/8"	0.014"	6500	1	On Request
C517	5"	14 mm	0.014"	6500	1	On Request
<b>Thick wire</b>						
C523	5"	5/8"	0.020"	6500	1	On Request
C524	5"	14 mm	0.020"	6500	1	On Request

TWISTED CUP BRUSHES WITH CARBON STEEL WITH SHANK



- Carbon steel twisted wire.
- Ideal for cleaning in hard-to-reach areas.
- High material removal capacity.
- For use with angle grinders.



ITEM	DIAMETER	THREAD	WIRE GAUGE	MAX SPEED	☑	AVAILABLE
<b>Thin wire</b>						
C582	1-1/8"	1/4"	0.014"	4500	1	On Request
<b>Thick wire</b>						
C584	1-1/8"	1/4"	0.020"	4500	1	On Request

STAINLESS STEEL TWISTED CUP BRUSHES



- Stainless steel twisted wire.
- Ideal for cleaning in hard-to-reach areas.
- High material removal capacity.
- Corrosion resistant, suitable for humid or aggressive environments.
- For use with angle grinders.



C606 Thin wire



ITEM	DIAMETER	THREAD	WIRE GAUGE	MAX SPEED	☑	AVAILABLE
<b>Thin wire</b>						
C606	3"	5/8"	0.014"	12500	1	On Request
C607	3"	14mm	0.014"	12500	1	On Request
<b>Thick wire</b>						
C612	3"	5/8"	0.020"	12500	1	On Request
C613	3"	14mm	0.020"	12500	1	On Request
C614	4"	5/8"	0.020"	8500	1	On Request
C615	4"	14mm	0.020"	8500	1	On Request

## WIRE CUP BRUSHES

### CRIMPED WIRE CUP BRUSH



- High-strength carbon steel wire.
- Suitable for high-speed operation.
- Ideal for large surface work.
- High material removal capacity.
- Excellent wear resistance.
- For heavy-duty jobs such as cleaning metal plates, frames, rust, paint, and general residues.
- For use with angle grinders.



ITEM	DIAMETER	THREAD	WIRE GAUGE	MAX SPEED	☞	AVAILABLE
<b>Thin wire</b>						
C812	3"	5/8"	0.014"	12500	1	On Request
C813	3"	14 mm	0.014"	12500	1	On Request
C814	4"	5/8"	0.014"	8500	1	On Request
C815	4"	14 mm	0.014"	8500	1	On Request
<b>Thick wire</b>						
C822	5"	5/8"	0.020"	6500	1	On Request
C823	5"	14 mm	0.020"	6500	1	On Request

### CARBON STEEL CRIMPED CUP BRUSHES WITH SHANK



- Brass-coated carbon steel wire provides extra strength to fine wires.
- Crimped wire design for light-duty work.
- High heat resistance.
- Suitable for high-speed operation.
- Ideal for large surface applications.
- Performs well on irregular surfaces.
- For use with drills.



ITEM	DIAMETER	SHANK	WIRE GAUGE	MAX SPEED	☞	AVAILABLE
<b>Fine wire</b>						
C841	1-3/4"	1/4"	0.006"	20000	1	On Request
C843	2-3/4"	1/4"	0.006"	20000	1	On Request
<b>Thin wire</b>						
C844	3/4"	1/4"	0.012"	20000	1	On Request
C845	1"	1/4"	0.012"	20000	1	On Request
C846	1-1/8"	1/4"	0.012"	20000	1	On Request
C847	1-3/4"	1/4"	0.012"	20000	1	On Request
C849	2-3/4"	1/4"	0.012"	4500	1	On Request

### STAINLESS STEEL CRIMPED CUP BRUSHES



- High-strength carbon steel wire.
- Suitable for high-speed operation.
- Ideal for cleaning in hard-to-reach areas.
- High material removal capacity.
- Excellent corrosion resistance, suitable for humid or aggressive environments.
- Perfect for heavy-duty jobs such as cleaning metal plates, frames, rust, paint, and general residues.
- For use with angle grinders.



ITEM	DIAMETER	THREAD	WIRE GAUGE	MAX SPEED	☞	AVAILABLE
<b>Thin wire</b>						
C936	5"	5/8"	0.012"	6500	1	On Request
C937	5"	14mm	0.012"	6500	1	On Request
<b>Thick wire</b>						
C942	5"	5/8"	0.020"	6500	1	On Request
C943	5"	14mm	0.020"	6500	1	On Request

### CRIMPED WIRE CUP BRUSHES



Item	Diameter	Replace to
C500	3"	123228
C501	3"	123229
C502	4"	123230
C503	4"	123231
C504	5"	123232
C505	5"	123233



- Carbon steel wire.
- Ideal for cleaning in hard-to-reach areas.
- High material removal capacity.
- Corrosion resistant, suitable for humid or aggressive environments.
- For use with angle grinders.

ITEM	DIAMETER	THREAD	WIRE GAUGE	MAX SPEED	☞	AVAILABLE
<b>Thin wire</b>						
C500	3"	5/8"	0.014"	12500	1	On Request
C501	3"	14 mm	0.014"	12500	1	On Request
C502	4"	5/8"	0.014"	8500	1	On Request
C503	4"	14 mm	0.014"	8500	1	On Request
C504	5"	5/8"	0.014"	6500	1	On Request
C505	5"	14 mm	0.014"	6500	1	On Request

### 1/4" SHANK CUP BRUSHES



Item	Diameter	Replaces to
C572	1-3/4"	123254
C574	2-3/4"	123255
C575	3/4"	123256
C576	1"	123257
C577	1-1/8"	123258
C578	1-3/4"	123252
C580	2-3/4"	123253



- Brass-coated carbon steel wire provides extra strength to fine wires.
- Crimped wire design for light-duty work.
- Ideal for large surface applications.
- Performs well on irregular surfaces.
- For use with drills.

ITEM	DIAMETER	SHANK	WIRE GAUGE	MAX SPEED	☞	AVAILABLE
<b>Fine wire</b>						
C572	1-3/4"	1/4"	0.006"	4500	1	On Request
C574	2-3/4"	1/4"	0.006"	4500	1	On Request
<b>Thin wire</b>						
C575	3/4"	1/4"	0.012"	4500	1	On Request
C576	1"	1/4"	0.012"	4500	1	On Request
C577	1-1/8"	1/4"	0.012"	4500	1	On Request
C578	1-3/4"	1/4"	0.012"	4500	1	On Request
C580	2-3/4"	1/4"	0.012"	4500	1	On Request

### STAINLESS STEEL CRIMPED CUP BRUSHES - THIN & HEAVY WIRE



- Stainless steel wire.
- Ideal for cleaning in hard-to-reach areas.
- High material removal capacity.
- Corrosion resistant, suitable for humid or aggressive environments.
- For use with angle grinders.



ITEM	DIAMETER	THREAD	WIRE GAUGE	MAX SPEED	☞	AVAILABLE
<b>Thin wire</b>						
C604	5"	5/8"	0.012"	6500	1	On Request
C605	5"	14mm	0.012"	6500	1	On Request

## WIRE CUP BRUSHES

### STAINLESS STEEL CRIMPED CUP BRUSHES - FINE AND THIN WIRE, WITH SHANK



**C952**  
Fine wire

- Stainless steel wire.
- Suitable for high-speed operation.
- Ideal for cleaning in hard-to-reach areas.
- High material removal capacity.
- Excellent wear resistance.
- For heavy-duty jobs such as cleaning metal plates, frames, rust, paint, and general residues.
- For use with angle grinders.

ITEM	DIAMETER	THREAD	WIRE GAUGE	MAX SPEED	☞	AVAILABLE
<b>Fine wire</b>						
<b>C952</b>	1/2"	1/4"	0.20 mm	20000	1	On Request
<b>Thin wire</b>						
<b>C953</b>	1/2"	1/4"	0.012"	20000	1	On Request
<b>C954</b>	7/8"	1/4"	0.012"	20000	1	On Request

### STAINLESS STEEL CRIMPED CUP BRUSHES - FINE AND THIN WIRE, WITH SHANK



**C627**  
Fine wire

- Stainless steel wire.
- Ideal for cleaning in hard-to-reach areas.
- High material removal capacity.
- Corrosion resistant, suitable for humid or aggressive environments.
- For use with angle grinders.

ITEM	DIAMETER	THREAD	WIRE GAUGE	MAX SPEED	☞	AVAILABLE
<b>Fine wire</b>						
<b>C627</b>	1/2"	1/4"	0.20 mm	20000	1	On Request
<b>Thin wire</b>						
<b>C628</b>	1/2"	1/4"	0.012"	20000	1	On Request
<b>C629</b>	7/8"	1/4"	0.012"	4500	1	On Request

## WIRE WHEEL BRUSHES

### CARBON STEEL TWISTED WIRE WHEEL BRUSHES WITH THREAD



**C827**

- For aggressive, high-impact brushing.
- Ideal for heavy-duty applications such as preparing and finishing mechanical parts, cleaning welds, paint, plastic residues, and corrosion.

ITEM	DIAMETER	THREAD	WIRE GAUGE	MAX SPEED	☞	AVAILABLE
<b>Thin wire</b>						
<b>C824</b>	4"	5/8"	0.014"	12500	1	On Request
<b>C825</b>	4"	14 mm	0.014"	12500	1	On Request
<b>C826</b>	6"	5/8"	0.014"	9000	1	On Request
<b>C827</b>	6"	14 mm	0.014"	9000	1	On Request
<b>Thick wire</b>						
<b>C828</b>	4"	5/8"	0.020"	12500	1	On Request
<b>C829</b>	4"	14 mm	0.020"	12500	1	On Request
<b>C832</b>	7"	7/8"	0.020"	9000	1	On Request

### CARBON STEEL TWISTED WIRE WHEEL BRUSHES WITH THREAD



**C528**

- Removes weld scale, rust, burrs, and general residues.
- Ideal for rust cleaning on parts and surfaces.

Item	Diameter	Replaces to
<b>C536</b>	6"	123225

ITEM	DIAMETER	CENTER	WIRE GAUGE	MAX SPEED	☞	AVAILABLE
<b>Thin wire</b>						
<b>C528</b>	4"	5/8"	0.014"	12500	1	On Request
<b>C529</b>	4"	14mm	0.014"	12500	1	On Request
<b>Thick wire</b>						
<b>C532</b>	4"	5/8"	0.020"	12500	1	On Request
<b>C533</b>	4"	14mm	0.020"	12500	1	On Request
<b>C536</b>	6"	5/8"	0.020"	9000	1	On Request
<b>C538</b>	7"	7/8"	0.020"	9000	1	On Request

### CARBON STEEL TWISTED WIRE WHEEL BRUSH - HEAVY GAUGE WIRE



Item	Diameter	Replace to
<b>C527</b>	6"	123224

- Removes weld scale, rust, burrs, and general residues.
- For rust cleaning on parts and surfaces.

ITEM	DIAMETER	CENTER	WIRE GAUGE	MAX SPEED	☞	AVAILABLE
<b>Thick wire</b>						
<b>C527</b>	6"	5/8"	0.020"	8000	1	On Request

### CARBON STEEL TWISTED WIRE WHEEL BRUSHES WITH SHANK - THIN AND HEAVY GAUGE WIRE



**C850**

- Aggressive action for weld seams, slag, and scale removal.
- High tensile strength for longer life.
- Durable special-quality wires provide excellent flexibility and adaptability.

ITEM	DIAMETER	THREAD	WIRE GAUGE	MAX SPEED	☞	AVAILABLE
<b>Thin wire</b>						
<b>C850</b>	3"	1/4"	0.012"	12000	1	On Request
<b>Thick wire</b>						
<b>C852</b>	3"	1/4"	0.020"	12000	1	On Request

## WIRE WHEEL BRUSHES

### STAINLESS STEEL TWISTED WIRE WHEEL BRUSHES WITH SHANK



NEW



C566

- Aggressive action for weld seams, slag, and scale removal.
- Long service life with special-quality wires offering excellent flexibility and adaptability.



ITEM	DIAMETER	THREAD	WIRE GAUGE	MAX SPEED	☞	AVAILABLE
<b>Thin wire</b>						
C566	3"	1/4"	0.012"	12000	1	On Request
<b>Thick wire</b>						
C569	3"	1/4"	0.020"	12000	1	On Request

### STAINLESS STEEL TWISTED WIRE WHEEL BRUSHES WITH THREAD - HEAVY GAUGE WIRE



NEW



C623

- Aggressive action for weld seams, slag, and scale removal.
- High tensile strength for longer life.
- Special-quality wires provide extended durability with excellent flexibility and adaptability.



ITEM	DIAMETER	THREAD	WIRE GAUGE	MAX SPEED	☞	AVAILABLE
C623	4"	5/8"	0.020"	12500	1	On Request
C624	4"	14mm	0.020"	12500	1	On Request

### CARBON STEEL CRIMPED WIRE WHEEL BRUSHES WITH THREAD



NEW



C587

- Brass-coated bristles.



ITEM	DIAMETER	THREAD	WIRE GAUGE	MAX SPEED	☞	AVAILABLE
C587	4-1/2"	5/8"	0.012"	4500	1	On Request
C588	4-1/2"	14mm	0.012"	4500	1	On Request
C589	6"	5/8"	0.014"	6000	1	On Request
C590	6"	14mm	0.014"	6000	1	On Request

### STAINLESS STEEL TWISTED WIRE WHEEL BRUSHES WITH THREAD



NEW



C944

- Aggressive action for weld seams, slag, and scale removal.
- High tensile strength for extended durability.
- Special-quality wires ensure long life with excellent flexibility and adaptability.



ITEM	DIAMETER	THREAD	WIRE GAUGE	MAX SPEED	☞	AVAILABLE
<b>Thin wire</b>						
C944	4"	5/8"	0.014"	12500	1	On Request
C945	4"	14mm	0.014"	12500	1	On Request
C946	6"	5/8"	0.40mm	9000	1	On Request
C947	6"	14mm	0.40mm	9000	1	On Request
<b>Thick wire</b>						
C948	4"	5/8"	0.020"	12500	1	On Request
C949	4"	14mm	0.020"	12500	1	On Request

### STAINLESS STEEL TWISTED WIRE WHEEL BRUSH WITH SHANK



NEW



- Aggressive action for weld seams, slag, and scale removal.
- High tensile strength for longer service life.
- Special-quality wires ensure durability with excellent flexibility and adaptability.



ITEM	DIAMETER	THREAD	WIRE GAUGE	MAX SPEED	☞	AVAILABLE
C960	3"	1/4"	0.014"	12000	1	On Request

### CRIMPED WIRE WHEEL BRUSHES



NEW



C833

- For light to medium brushing.
- Ideal for fine finishing, removing rust, paint, residues, burrs, and polishing rough surfaces.
- Includes adapters for 1/2", 5/8", 3/4", 7/8", and 1" arbors.



ITEM	DIAMETER	CENTER	WIRE GAUGE	THICKNESS	MAX SPEED	☞	AVAILABLE
C833	6"	1-1/4"	0.014"	1"	6000	1	On Request
C834	8"	1-1/4"	0.014"	1"	4500	1	On Request
C835	12"	Multi-axis	0.012"	1"	3000	1	On Request

WIRE WHEEL BRUSHES

CARBON STEEL CRIMPED WIRE WHEEL BRUSHES WITH 1-1/4" CENTER

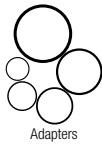

Item	Diameter	Replaces to
C541	6"	123220
C542	6"	123221
C543	6"	123222



C541

- Carbon steel wire.
- Crimped wire for light-duty work.
- Suitable for high-speed operation.
- Performs well on irregular surfaces.
- Includes adapters for 1/2", 5/8", 3/4", 7/8", and 1".
- Useful for removing burrs, forge scale, and casting sand.
- For use with bench grinders.

ITEM	DIAMETER	CENTER	WIRE GAUGE	MAX SPEED	⚡	AVAILABLE
C591	4"	Multi-axis	0.012"	6000	1	On Request
C593	6"	Multi-axis	0.012"	6000	1	On Request
C541	6"	1-1/4"	0.014"	6500	1	On Request
C542	6"	1-1/4"	0.014"	6500	1	On Request
C543	6"	1-1/4"	0.014"	6500	1	On Request

CARBON STEEL CRIMPED WIRE WHEEL BRUSHES WITH 1/2" CENTER



C539

Item	Diameter	Replaces to
C539	6"	123218
C540	6"	123219

- Carbon steel wire.
- Crimped wire for light-duty work.
- Suitable for high-speed operation.
- Performs well on irregular surfaces.
- Removes weld scale, rust, burrs, and general residues.
- For use with bench grinders.

ITEM	DIAMETER	CENTER	WIRE GAUGE	MAX SPEED	⚡	AVAILABLE
<b>Thin wire</b>						
C539	6"	1/2"	0.014"	6000	1	On Request
C540	6"	1/2"	0.014"	6000	1	On Request

CARBON STEEL CRIMPED WIRE WHEEL BRUSHES - FINE AND THIN WIRE, WITH SHANK



C546

Item	Diameter	Replaces to
C546	1-1/2"	123245
C547	2"	123246
C548	3"	123247
C549	4"	123248
C562	2"	123250
C563	3"	123251
C564	4"	123249

- High-carbon steel crimped wire.
- Brass-coated bristles.

ITEM	DIAMETER	SHANK	WIRE GAUGE	MAX SPEED	⚡	AVAILABLE
<b>Fine wire</b>						
C546	1-1/2"	1/4"	0.006"	4500	1	On Request
C547	2"	1/4"	0.006"	4500	1	On Request
C548	3"	1/4"	0.006"	4500	1	On Request
C549	4"	1/4"	0.006"	4500	1	On Request
<b>Thin wire</b>						
C562	2"	1/4"	0.012"	4500	1	On Request
C563	3"	1/4"	0.012"	4500	1	On Request
C564	4"	1/4"	0.012"	4500	1	On Request

CARBON STEEL CRIMPED WIRE WHEEL BRUSH, MULTI-ARBOR



- Includes adapters for 1/2", 5/8", 3/4", 7/8", and 1".
- Useful for removing burrs, forge scale, and casting sand.
- Manufactured from high-carbon steel.

ITEM	DIAMETER	THREAD	WIRE GAUGE	MAX SPEED	⚡	AVAILABLE
C544	12"	Multi-axis	21/32"	3000	1	On Request

CARBON STEEL CRIMPED WIRE WHEEL BRUSHES - FINE AND THIN WIRE, WITH SHANK



C854

- Brass-coated carbon steel wire provides extra strength to fine wires.
- Crimped wire for light-duty work.
- Ideal for large surface applications.
- Performs well on irregular surfaces.
- Excellent wear resistance.
- For use with drills.

ITEM	DIAMETER	THREAD	WIRE GAUGE	MAX SPEED	⚡	AVAILABLE
<b>Fine wire</b>						
C854	1-1/2"	1/4"	0.006"	4500	1	On Request
C855	2"	1/4"	0.006"	4500	1	On Request
C856	3"	1/4"	0.006"	4500	1	On Request
C857	4"	1/4"	0.006"	4500	1	On Request
<b>Thin wire</b>						
C859	2"	1/4"	0.012"	4500	1	On Request
C860	3"	1/4"	0.012"	4500	1	On Request
C861	4"	1/4"	0.012"	4500	1	On Request

STAINLESS STEEL CRIMPED WIRE WHEEL BRUSHES WITH THREAD



C958

- Aggressive action for weld seams, slag, and scale removal.
- High tensile strength for longer life.
- Special-quality wires provide extended durability with excellent flexibility and adaptability.

ITEM	DIAMETER	THREAD	WIRE GAUGE	MAX SPEED	⚡	AVAILABLE
C958	6"	5/8"	0.012"	6000	1	On Request
C959	6"	14mm	0.012"	6000	1	On Request

## WIRE WHEEL BRUSHES

### STAINLESS STEEL CRIMPED WIRE WHEEL BRUSHES WITH THREAD



NEW



C620



- Aggressive action for weld seams, slag, and scale removal.
- High tensile strength for extended durability.
- Special-quality wires ensure long life with excellent flexibility and adaptability.

ITEM	DIAMETER	THREAD	WIRE GAUGE	MAX SPEED	⊞	AVAILABLE
C620	6"	5/8"	0.012"	6000	1	On Request
C621	6"	14mm	0.012"	6000	1	On Request

### STAINLESS STEEL CRIMPED WIRE WHEEL BRUSHES WITH SHANK



NEW



C961



- Aggressive action for weld seams, slag, and scale removal.
- High tensile strength for extended durability.
- Special-quality wires ensure long life with excellent flexibility and adaptability.

ITEM	DIAMETER	THREAD	WIRE GAUGE	MAX SPEED	⊞	AVAILABLE
C961	2"	1/4"	0.012"	12000	1	On Request
C962	2-3/4"	1/4"	0.012"	15000	1	On Request

### STAINLESS STEEL KNOT WIRE END BRUSH WITH SHANK



NEW



- Aggressive action for weld seams, slag, and scale removal.
- High tensile strength for extended durability.
- Special-quality wires ensure long life with excellent flexibility and adaptability.

ITEM	DIAMETER	THREAD	WIRE GAUGE	MAX SPEED	⊞	AVAILABLE
C964	3/8"	1/4"	0.012"	20,000	1	On Request

### STAINLESS STEEL KNOT WIRE END BRUSH WITH SHANK



NEW



- Aggressive action for weld seams, slag, and scale removal.
- High tensile strength for extended durability.
- Special-quality wires ensure long life with excellent flexibility and adaptability.

ITEM	DIAMETER	THREAD	WIRE GAUGE	MAX SPEED	⊞	AVAILABLE
C630	3/8"	1/4"	0.012"	20000	1	On Request

## WIRE BRUSHES

### STAINLESS STEEL WIRE



To card	Stainless steel	Aluminum	Copper

- Ideal for cleaning surfaces without contamination.
- Removes weld spatter, rust, and casting residues.
- Suitable for deburring flat areas.

### CARBON STEEL WIRE



To card	Steel	Concrete	Wood

- Useful for cleaning surfaces, removing rust, scraping paint, and eliminating tough materials.
- Removes weld scale.
- Removes sand from cast parts.
- Ideal for working on small imperfections in concrete, metal, or wood surfaces.

### BRASS STEEL WIRE



To card	Steel	Aluminum	Copper	Plastic

- Ideal for static reduction, surface cleaning, metal polishing, and material removal.
- Effective for removing weld slag and rust from metals.
- Does not produce sparks when in contact with other surfaces.

### STAINLESS STEEL WIRE BRUSH



- Ideal for applications where contamination reduction is required in the work area.



- Plastic handle.

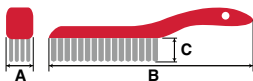

Dimensions	
A - Width	31.4 mm
B - Total length	265 mm
C - Height	28 mm
Bristles	4 x 16

- Reinforced steel wires provide greater resistance.

ITEM	WIDTH	TOTAL LENGTH	⊞	AVAILABLE
1885CSS	15/16"	10-5/8"	1	On Request

### REINFORCED STEEL WIRE BRUSH



- Plastic handle with ergonomic design for easy grip that reduces fatigue.



- Reinforced steel wires provide greater resistance.



Dimensions	
A - Width	31.4 mm
B - Total length	265 mm
C - Height	28 mm
Bristles	4 x 16

- Useful for deburring wood, metal, or plastic.

ITEM	WIDTH	TOTAL LENGTH	⊞	AVAILABLE
1885CR	15/16"	10-5/8"	1	On Request

WIRE BRUSHES

WIRE BRUSHES



123262



123260



123261



123259



123278

- Ideal for brushing large, flat surfaces.
- Useful for applying greater pressure and removing stubborn residues.



- High-carbon steel wires.
- Wire gauge: 0.35 mm.
- Body made of polypropylene.



- With scraper attached to the end of the handle, useful for removing excess paint without affecting the rest of the surface.



- Body made of polypropylene coated with neoprene.



ITEM	BRUSHES	WIDTH (A)	WIDTH (B)	WIRE HEIGHT (C)	TOTAL LENGTH (E)	☞	AVAILABLE
<b>Without handle</b>							
123262	6 x 19	4.8 cm	15.5 cm	3 cm	17 cm	6	On Request
123263	9 x 20	6.9 cm	16.5 cm	3 cm	18.5 cm	6	On Request
<b>With handle</b>							
123260	4 x 16	3.2 cm	13 cm	3 cm	27 cm	6	On Request
123261	3 x 17	2.4 cm	14 cm	3 cm	29.5 cm	6	On Request

ITEM	BRUSHES	WIDTH (A)	WIDTH (B)	WIRE HEIGHT (C)	TOTAL LENGTH (E)	☞	AVAILABLE
<b>Whit handle and scraper</b>							
123259	3 x 17	2.4 cm	14 cm	3 cm	29.5 cm	6	On Request
<b>With material handle</b>							
123278	4 x 16	2.8 cm	12 cm	3 cm	26 cm	1	On Request

BRASS WIRE BRUSH



123279

- Brass-coated steel wire (anti-spark).
- Wire gauge: 0.32 mm.
- Strong binding prevents wire loosening.



BULK

ITEM	WIDTH (A)	WIDTH (B)	WIRE HEIGHT (C)	TOTAL LENGTH (E)	☞	AVAILABLE
<b>Brass (non-sparking)</b>						
123279	1 cm	13 cm	3 cm	24.5 cm	1	On Request



CARPENTER'S PLANES AND SCRAPES

SMOOTH HAND PLANES



Smooth Base



120404



120405



NEW

- Blade fastening system with bronze screw.
- Blade height adjustment nut.
- Ergonomic knob and handle made of fine polished and lacquered wood.
- High-carbon steel blade, polished, ground, and pre-sharpened at 25°.



ITEM	NUMBER	KNOB AND HANDLE MATERIAL	☞	AVAILABLE
120404	4	Plastic	1	On Request
120405	5	Wood	1	On Request

CORRUGATED BASE HAND PLANE



Corrugated Base



120414



120416



NEW

- Blade fastening system with bronze screw.
- Blade height adjustment nut.
- Ergonomic knob and handle made of fine polished and lacquered wood.
- High-carbon steel blade, polished, ground, and pre-sharpened at 25°.



ITEM	NUMBER	KNOB AND HANDLE MATERIAL	☞	AVAILABLE
120414	4	Wood	1	On Request
120415	5	Wood	1	On Request
120416	6	Plastic	1	On Request

## CARPENTER'S PLANES AND SCRAPES

### HAND PLANE REPLACEMENT BLADES



120433

- Ground cutting angles.

ITEM	NUMBER	⊞	AVAILABLE
120431	3	6	On Request
120432	4 & 5	6	On Request
120433	6	6	On Request

### SPOKESHAVES



Straight face

120418



Curved face

120419

- Body made of ductile cast iron.
- Ideal for chamfering concave or convex surfaces.
- Dual knurled adjustment screws.

ITEM	CUTTING WIDTH	FACE	⊞	AVAILABLE
120418	2-1/8"	Straight	3	On Request
120419	2-1/8"	Curved	3	On Request

### BIMETAL HOLE SAWS

#### BI-METAL HOLE SAW SET



12 PIECES



- Exceeds ANSI B94.54 standard.

Content	Description	Qty.
Hole saw	3/4", 7/8", 1-1/8", 1-3/8", 1-1/2", 1-3/4", 2", 2-1/4" & 2-1/2"	9
Mandrel guide	3/8" with thread 1/2"-20	1
Mandrel guide	7/16" with thread 5/8"-20	1
Drill tip		1

ITEM	PIECES	⊞	AVAILABLE
JHS12	12	1	On Request

#### BI-METAL HOLE SAW SET



8 PIECES



- Exceeds ANSI B94.54 standard.

Content	Description	Qty.
Hole saw	7/8", 1-1/8", 1-3/8", 1-3/4", 2" & 2-1/2"	9
Mandrel guide	3/8" with thread 1/2"-20	1
Mandrel guide	7/16" with thread 5/8"-20	2

ITEM	PIECES	⊞	AVAILABLE
JHS8	8	1	On Request

#### BI-METAL HOLE SAW SET



13 PIECES



- Meets ANSI B94.54 standard.

Content	Description	Qty.
Hole saw	3/4", 7/8", 1-1/8", 1-3/8", 1-1/2", 1-3/4", 2", 2-1/4", 2-1/2"	9
Mandrel guide	3/8"	1
Mandrel guide	1/4"	1
Adapter	3/8", 7/16"	1
Drill tip	6 x 60 mm	1

ITEM	PIECES	⊞	AVAILABLE
120757	13	1	On Request

#### BI-METAL HOLE SAW



HS3/4



HS1-1/8

- Standard: ANSI B94.54.

ITEM	DIAMETER	⊞	AVAILABLE
HS9/16	9/16"	1	On Request
HS5/8	5/8"	1	On Request
HS11/16	11/16"	1	On Request
HS3/4	3/4"	1	On Request
HS7/8	7/8"	1	On Request
HS1	1"	1	On Request
HS1-1/16	1-1/16"	1	On Request

ITEM	DIAMETER	⊞	AVAILABLE
HS1-1/8	1-1/8"	1	On Request
HS1-3/16	1-3/16"	1	On Request
HS1-1/4	1-1/4"	1	On Request
HS1-3/8	1-3/8"	1	On Request
HS1-7/16	1-7/16"	1	On Request
HS1-1/2	1-1/2"	1	On Request
HS1-9/16	1-9/16"	1	On Request

ITEM	DIAMETER	⊞	AVAILABLE
HS1-5/8	1-5/8"	1	On Request
HS1-11/16	1-11/16"	1	On Request
HS1-3/4	1-3/4"	1	On Request
HS1-7/8	1-7/8"	1	On Request
HS2	2"	1	On Request
HS2-1/8	2-1/8"	1	On Request
HS2-1/4	2-1/4"	1	On Request

ITEM	DIAMETER	⊞	AVAILABLE
HS2-3/8	2-3/8"	1	On Request
HS2-1/2	2-1/2"	1	On Request
HS2-3/4	2-3/4"	1	On Request
HS3	3"	1	On Request
HS3-1/2	3-1/2"	1	On Request
HS3-3/4	3-3/4"	1	On Request



**BIMETAL HOLE SAWS**

**BI-METAL HOLE SAW**



**NEW**



120733



120740



120749

- Manufactured from alloy steel.
- For use with portable electric drills or drill presses.

ITEM	DIAMETER	QTY	AVAILABLE
120731	9/16"	3	On Request
120732	5/8"	3	On Request
120733	3/4"	3	On Request
120734	7/8"	3	On Request
120735	1"	3	On Request

ITEM	DIAMETER	QTY	AVAILABLE
120736	1-1/16"	3	On Request
120737	1-1/8"	3	On Request
120738	1-3/16"	3	On Request
120739	1-1/4"	3	On Request
120740	1-3/8"	3	On Request

ITEM	DIAMETER	QTY	AVAILABLE
120741	1-1/2"	3	On Request
120742	1-9/16"	3	On Request
120743	1-3/4"	3	On Request
120744	2"	3	On Request
120745	2-1/8"	3	On Request

ITEM	DIAMETER	QTY	AVAILABLE
120746	2-1/4"	3	On Request
120747	2-3/8"	3	On Request
120748	2-1/2"	3	On Request
120749	2-3/4"	3	On Request

**HOLE-SAW SETS**



**9 PIECES**



120753

Content	Description	Qty.
Hole saw	1", 1-1/4", 1-1/2", 1-3/4", 2", 2-1/2"	6
Mandrel guide	3/8", 1/4"	2
Hex L-Key	2.5 mm	1

**15 PIECES**



120754

Content	Description	Qty.
Hole saw	3/4", 7/8", 1", 1-1/8", 1-1/4", 1-3/8", 1-1/2", 1-3/4", 2", 2-1/4", 2-1/2", 3"	12
Mandrel guide	3/8", 1/4"	2
Hex L-Key	2.5 mm	1

- Manufactured from carbon steel.
- Standard: ANSI B94.54.

ITEM	PIECES	QTY	AVAILABLE
120753	9	1	On Request
120754	15	1	On Request



VIDEO

**HOLE-SAW SETS**



**5 PIECES**

Content	Description	Qty.
Hole saw	1-1/4", 1-1/2", 2", 2-1/8"	4
Mandrel guide	3/8"	1

**4 PIECES**

Content	Description	Qty.
Hole saw	7/8", 1", 2-1/8"	3
Mandrel guide	1/4"	1

**3 PIECES**

Content	Description	Qty.
Hole saw	2-1/8"	1
Mandrel guide	3/8"	1
Flat wood bit	7/8"	1

- Standard: ANSI B94.54.

ITEM	PIECES	QTY	AVAILABLE
120752	5	3	On Request
120751	4	3	On Request
120750	3	3	On Request

**HEX SHANK HOLE SAW ARBOR**



HSA76



Threaded coupling.

HSA38



ITEM	SHANK TYPE	FOR DIAMETERS	QTY	AVAILABLE
HSA38	3/8"	9/16" a 1-3/16"	4	On Request
HSA76	7/16"	1-1/4" a 3-3/4"	4	On Request

**HEX SHANK HOLE SAW ARBOR**



120755

ITEM	SHANK TYPE	FOR DIAMETERS	QTY	AVAILABLE
120755	3/8"	9/16" - 1-3/16"	6	On Request
120756	7/16"	1-1/4" - 2-3/4"	6	On Request



**NEW**



## ROUGHING END MILLS

### ROUGHING END MILLS



URREA  
Specialty Tools & Equipment Inc.



CVD14

- Designed for heavy roughing with straight, clean finishes.
- Made from M42 high-speed steel with 8% cobalt for longer tool life.
- Ideal for low-hardness steels, aluminum, and copper alloys.
- Safety-notch shank prevents slipping.
- 3, 4, or 5 flutes for faster chip removal and smoother results.



ITEM	CUT DIAMETER	SHANK DIAMETER	CUTTING LENGTH	TOTAL LENGTH	NUMBER OF FLUTES	Ø	AVAILABLE
CVD316	3/16"	3/8"	1/2"	2-3/8"	3	1	On Request
CVD14	1/4"	3/8"	5/8"	2-7/16"	3	1	On Request
CVD516	5/16"	3/8"	3/4"	2-1/2"	3	1	On Request
CVD38	3/8"	3/8"	3/4"	2-1/2"	4	1	On Request
CVD716	7/16"	3/8"	1"	2-11/16"	4	1	On Request
CVD12	1/2"	1/2"	1-1/4"	3-1/4"	4	1	On Request
CVD58	5/8"	5/8"	1-5/8"	3-3/4"	4	1	On Request

### FINISHING END MILLS



URREA  
Specialty Tools & Equipment Inc.



CV418

- Flat end mills with 4 flutes and center cutting for smooth, precise finishes.
- Made from M42 high-speed steel with 8% cobalt for durability.
- Ideal for low-hardness steels, aluminum, and copper alloys.
- Safety-notch shank prevents slipping.
- 4-flute design ensures better chip removal and finer results.



ITEM	CUT DIAMETER	SHANK DIAMETER	CUTTING LENGTH	TOTAL LENGTH	NUMBER OF FLUTES	Ø	AVAILABLE
CV418	1/8"	3/8"	3/8"	2-5/16"	4	1	On Request
CV4316	3/16"	3/8"	1/2"	2-3/8"	4	1	On Request
CV414	1/4"	3/8"	5/8"	2-7/16"	4	1	On Request
CV4516	5/16"	3/8"	3/4"	2-1/2"	4	1	On Request
CV438	3/8"	3/8"	3/4"	2-1/2"	4	1	On Request
CV4716	7/16"	3/8"	1"	2-11/16"	4	1	On Request
CV412	1/2"	1/2"	1-1/4"	3-1/4"	4	1	On Request
CV458	5/8"	5/8"	1-5/8"	3-3/4"	4	1	On Request
CV434	3/4"	3/4"	1-5/8"	3-7/8"	4	1	On Request
CV478	7/8"	7/8"	1-7/8"	4-1/8"	4	1	On Request
CV41	1"	1"	2"	4-1/2"	4	1	On Request

### ROUND-TIPPED END MILLS



URREA  
Specialty Tools & Equipment Inc.



- Center cutters.



CVR78

- Round end mills with 4 flutes and center cutting for concave circular surfaces.
- Made from HSS 1320 with 8% cobalt for added strength and durability.
- Ideal for low-hardness steels, aluminum, and bronze.
- Safety-notch shank prevents slipping in the tool holder.
- 4-flute design provides better chip removal and smoother finishes.



ITEM	CUT DIAMETER	SHANK DIAMETER	CUTTING LENGTH	TOTAL LENGTH	NUMBER OF FLUTES	Ø	AVAILABLE
CVR58	5/8"	5/8"	2-1/2"	4-5/8"	4	1	On Request
CVR78	7/8"	7/8"	1-7/8"	4-1/8"	4	1	On Request

## ANNULAR CUTTERS

### HIGH-SPEED STEEL ANNULAR CUTTERS



**WELDON SHANK**

**HSS HIGH SPEED STEEL**

To cut	Steel	Stainless steel	Aluminum	Magnesium	Bronze	Copper	Wood	Plastic

URREA



NEW



- Specialized cutter for drilling in metal, wood, and plastic.
- Delivers fast, burr-free holes.

ITEM	SIZE	TOTAL LENGTH	SHANK	SHANK SIZE	DRILLING DEPTH	TEETH	Ø	AVAILABLE
COA12	1/2"	62 mm	Weldon	3/4" / 19 mm	1" / 25 mm	4	1	On Request
COA916	9/16"	62 mm	Weldon	3/4" / 19 mm	1" / 25 mm	4	1	On Request
COA58	5/8"	62 mm	Weldon	3/4" / 19 mm	1" / 25 mm	5	1	On Request
COA1116	11/16"	62 mm	Weldon	3/4" / 19 mm	1" / 25 mm	6	1	On Request
COA34	3/4"	62 mm	Weldon	3/4" / 19 mm	1" / 25 mm	6	1	On Request
COA78	7/8"	62 mm	Weldon	3/4" / 19 mm	1" / 25 mm	6	1	On Request
COA1516	15/16"	62 mm	Weldon	3/4" / 19 mm	1" / 25 mm	6	1	On Request
COA1	1"	62 mm	Weldon	3/4" / 19 mm	1" / 25 mm	6	1	On Request
COA118	1-1/8"	62 mm	Weldon	3/4" / 19 mm	1" / 25 mm	8	1	On Request
COA114	1-1/4"	62 mm	Weldon	3/4" / 19 mm	1" / 25 mm	8	1	On Request
COA158	1-5/8"	62 mm	Weldon	3/4" / 19 mm	1" / 25 mm	10	1	On Request
COA2	2"	62 mm	Weldon	3/4" / 19 mm	1" / 25 mm	12	1	On Request

### PILOT DRILL FOR ANNULAR CUTTERS



URREA



NEW



- Guides smooth and easy drilling.
- Ejects the slug once the magnetic drill completes the cut.

ITEM	TOTAL LENGTH	DRILLING DEPTH	Ø	AVAILABLE
GC77	77 mm / 3"	1" / 25"	1	On Request

**URREA**  
SUPERIOR QUALITY AFFORDABLE TOOLS

**SUPERIOR Sharpness**

usa.urrea.com      HIGH-SPEED STEEL ANNULAR CUTTERS

CUTTING AND GRINDING TOOLS

## GLASS CUTTER

### GLASS CUTTER



URREA



NEW



- Tungsten carbide blade that holds its edge longer.
- Resists wear from friction, extending blade life.

ITEM	CUT CAPACITY	TOTAL LENGTH	Ø	AVAILABLE
101A	2-10mm	7"	1	On Request

### GLASS CUTTER



SURTEK



NEW



- Cast steel body with cutting wheel and weighted handle.
- 1/4" (6.3 mm) rotating blade.
- Three different notches for glass breaking.

ITEM	CUT CAPACITY	TOTAL LENGTH	Ø	AVAILABLE
101F	6 mm	5"	1	On Request

## FLOORING KNIFE

### CAMPING KNIFE



NEW



- Includes sheath.
- Full tang construction.
- For cutting, slicing, or skinning a wide variety of materials.
- Gut hook for opening game without damaging meat or internal organs.



ITEM	TOTAL LENGTH		BLADE LENGTH		HANDLE LENGTH		⊞	AVAILABLE
	in	mm	in	mm	in	mm		
685	8-5/16"	211	3-7/8"	98.4	4-3/8"	111	1	On Request

### FLOORING KNIFE



- Folding aluminum handle.
- Ideal for cutting and trimming vinyl, linoleum, roofing, and similar materials.



ITEM	TOTAL LENGTH		BLADE LENGTH		HANDLE LENGTH		⊞	AVAILABLE
	in	mm	in	mm	in	mm		
684	8"	203.2	3-1/2"	88.9	4-1/2"	114.3	1	On Request

### PROFESSIONAL FLOORING KNIFE



- Serrated blade made of carbon steel.
- For linoleum flooring, leather, cork, hide, carpets, and more.



ITEM	TOTAL LENGTH		BLADE LENGTH		HANDLE LENGTH		⊞	AVAILABLE
	in	mm	in	mm	in	mm		
120127	8"	203.2	3-1/2"	88.9	4 1/2"	114.3	1	On Request

### ACRYLIC CUTTER



- Replaceable blade.
- Includes 2 blades.



ITEM	TOTAL LENGTH		BLADE LENGTH		HANDLE LENGTH		⊞	AVAILABLE
	in	mm	in	mm	in	mm		
CUTA1	6-9/32"	160	1-9/16"	40	5-1/2"	140	6	On Request

**CUTTERS**

**25 MM PLASTIC CUTTER**

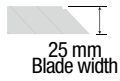

- Body made of zinc with ABS plastic coated in TPR.
- Rotary knob for quick and easy locking.

**25 mm plastic body cutter**

ITEM	CUTU4
TOTAL LENGTH	8"
BLADE WIDTH	25 mm
☞	1
AVAILABLE	On Request



CUTU4



**25 mm Replacement blades**

ITEM	CUTU4N
BLADE WIDTH	1"
CONTENT	10 blades
☞	1
AVAILABLE	On Request



CUTU4N

- SK4 steel blade.
- Includes plastic case for safe blade storage.



**25 MM CUTTERS**

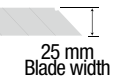

- Plastic body with bi-material handle.
- Automatic blade change.
- Includes 3 blades.
- 7-point blade, 0.7 mm thick.
- Blade width: 25 mm.

**25 mm plastic body cutter**

ITEM	CUTF25
TOTAL LENGTH	8"
BLADE WIDTH	1"
☞	1
AVAILABLE	On Request



CUTF25



**25 mm Replacement blades**

ITEM	REPCUTF25
BLADE WIDTH	1"
CONTENT	10 blades
☞	1
AVAILABLE	On Request



REPCUTF25

- Blades made of SK5 steel, with plastic case.



**22 MM ZINC ALLOY AUTOMATIC BLADE CHANGE CUTTER**

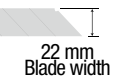

- Blade lock.
- Safety brake to secure the blade.
- Segmented blade.
- Capacity for 10 spare blades in cartridge.

**22 mm plastic body cutter**

ITEM	691
TOTAL LENGTH	6-1/2"
BLADE WIDTH	18 mm
☞	1
AVAILABLE	✓



## CUTTERS

### 18 MM STEEL BODY COVERED IN TPR CUTTER

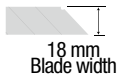

- Body made of zinc with ABS plastic coated in TPR.
- Rotary knob for quick and easy locking.



### 18 mm plastic body cutter

ITEM	CUTU1
TOTAL LENGTH	7-1/3"
BLADE WIDTH	18 mm
⊞	1
AVAILABLE	On Request

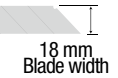

- Body made of zinc with ABS plastic coated in TPR.
- Rotary knob for quick and easy locking.



### 18 mm plastic body cutter

ITEM	CUTU3
TOTAL LENGTH	7-1/4"
BLADE WIDTH	18 mm
⊞	1
AVAILABLE	On Request

### 18 MM CUTTER

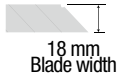

- Plastic body with bi-material handle.
- 8-point blade, 0.5 mm thick.
- Automatic blade change.

### 18 mm bimaterial plastic body cutter

ITEM	CUTF9
TOTAL LENGTH	8"
BLADE WIDTH	18 mm
⊞	6
AVAILABLE	On Request

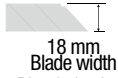

- Plastic body with safety lock button and device for removing worn blades.

### 18 mm plastic body cutter

ITEM	CUTF8
TOTAL LENGTH	8"
BLADE WIDTH	18 mm
⊞	6
AVAILABLE	✓



### 18 mm Replacement blades

ITEM	REPCUTF8
BLADE WIDTH	11/16"
CONTENT	10 blades
⊞	12
AVAILABLE	On Request



REPCUTF8

- Blades made of SK5 steel, with plastic case.



**CUTTERS**

**9 MM CUTTER**

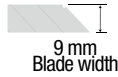

- Plastic body with bi-material handle.
- Automatic blade change, includes 3 blades.
- 13-point blades, 0.4 mm thick.

**9 mm plastic body cutter**

ITEM	CUTF14
TOTAL LENGTH	8"
BLADE WIDTH	11/32"
☞	1
AVAILABLE	On Request

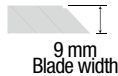

- Metal body with built-in device for removing worn blades.
- 13-point blades, 0.4 mm thick.

**9 mm plastic body cutter**

ITEM	CUTF13
TOTAL LENGTH	6"
BLADE WIDTH	11/32"
☞	1
AVAILABLE	On Request

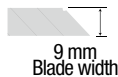

- Plastic body with safety lock button and built-in device for removing worn blades.
- 13-point blades, 0.4 mm thick.

**9 mm plastic body cutter**

ITEM	CUTF7
TOTAL LENGTH	8"
BLADE WIDTH	11/32"
☞	1
AVAILABLE	On Request



**9 mm Replacement blades**

ITEM	REPCUTF13
BLADE WIDTH	11/32"
CONTENT	10 blades
☞	6
AVAILABLE	On Request



REPCUTF13

- Blades made of SK5 steel, with plastic case.



## KNIVES

### FOLDING KNIFE WITH STAINLESS STEEL HANDLE



- 2-1/2" blade with ground edge, 100% stainless steel.
- Nylon sheath included.

ITEM	TOTAL LENGTH		⊞	AVAILABLE
	in	mm		
120562	6"	150	6	On Request

### FOLDING KNIFE WITH WOODEN HANDLE



- Steel handle with wood inlay.
- 2-1/2" stainless steel blade.

ITEM	TOTAL LENGTH		⊞	AVAILABLE
	in	mm		
120561	6"	150	6	On Request

### FOLDING KNIFE



- Stainless steel blade.
- 3-5/32" serrated stainless steel blade with bi-material handle.
- One-hand opening.
- Belt clip.

ITEM	TOTAL LENGTH		⊞	AVAILABLE
	in	mm		
120563	7-1/4"	182	1	On Request

### FOLDING KNIFE WITH PLASTIC HANDLE



120556

- 3-1/4" serrated stainless steel blade with plastic handle.
- One-hand opening.

ITEM	TOTAL LENGTH		⊞	AVAILABLE
	in	mm		
120556	7-1/8"	189	6	On Request



120550

- 2-3/4" serrated stainless steel blade with plastic handle.

ITEM	TOTAL LENGTH		⊞	AVAILABLE
	in	mm		
120550	6-3/4"	157	12	On Request

### DOUBLE FUNCTION FOLDABLE UTILITY KNIFE



- Includes standard and hook blades.
- Ideal for packaging, office work, or any application requiring continuous cutting.
- Aluminum handle.
- Dual function with foldable design to both sides.

ITEM	TOTAL LENGTH		⊞	AVAILABLE
	in	mm		
691F	6-1/2"	165.1	1	On Request

### FOLDABLE UTILITY KNIFE WITH CUTTING THREAD



- Ideal for packaging, office use, or any application requiring continuous cutting.
- Includes 10 blades.
- Anodized aluminum handle with comfortable grip

ITEM	TOTAL LENGTH		⊞	AVAILABLE
	in	mm		
692F	7"	177.8	1	On Request

### FOLDABLE UTILITY KNIFE WITH BITS



3/16" & 1/4" SLOTTED BITS INCLUDED

PH1 & PH2 PHILLIPS BITS INCLUDED

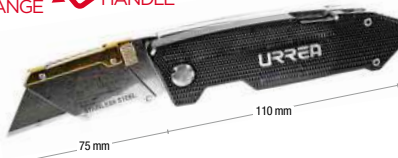

- Non-slip aluminum handle.
- Includes: 2 flat tips (3/16" and 1/4") and 2 Phillips® tips (PH1 and PH2).
- Includes 10 blades.
- Belt clip.
- Magnetic bit holder.
- Bit storage in handle.

ITEM	TOTAL LENGTH		⊞	AVAILABLE
	in	mm		
690F	7-1/4"	184.2	1	On Request

### FOLDABLE UTILITY KNIFE BIMATERIAL HANDLE



- Bi-material handle.
- Includes 4 standard blades, 2 hook blades, and a canvas pouch.

ITEM	TOTAL LENGTH		⊞	AVAILABLE
	in	mm		
NF10	6"	150	6	On Request

CUTTING AND GRINDING TOOLS



**KNIVES**

**FOLDABLE UTILITY KNIFE METALLIC HANDLE**



- Metal handle.
- Includes 4 standard blades and 2 hook blades.
- Meets GGG-K-494C standard.



ITEM	TOTAL LENGTH		☞	AVAILABLE
	in	mm		
NF11	6"	150	6	On Request

**CURVE RETRACTABLE UTILITY POCKET KNIFE**



25 mm (1")  
Blade width

- Blade width: 25 mm.
- Blade thickness: 0.6 mm.
- Body made of zinc with ABS plastic coated in TPR.
- Rotary knob for quick and easy locking.



ITEM	TOTAL LENGTH		☞	AVAILABLE
	in	mm		
690A	7"	177,8mm	1	On Request

**3 POSITIONS RETRACTABLE UTILITY POCKET KNIFE**



19 mm (3/4")  
Blade width

- Smooth blade advancement.
- Tool-free opening.
- Stores spare blades inside.



ITEM	TOTAL LENGTH		☞	AVAILABLE
	in	mm		
689	6-3/4"	171.4	1	On Request

**UTILITY KNIFE**



- Metal body.
- Non-slip handle.
- Push button for blade release and replacement.
- Includes 5 blades.
- Meets GGG-K-494C standard.



ITEM	TOTAL LENGTH		☞	AVAILABLE
	in	mm		
NF12	6"	150	1	On Request

**CURVE RETRACTABLE UTILITY KNIFE**



19 mm (3/4")  
Blade width

- Handle with non-slip grip.
- Spring system to minimize blade play.
- Stores spare blades inside.



ITEM	TOTAL LENGTH		☞	AVAILABLE
	IN	MM		
690	7-1/2"	190.5	1	On Request

**AUTOMATIC SAFETY RETRACTABLE UTILITY KNIFE**



19 mm (3/4")  
Blade width

- Ergonomic design.
- Stores spare blades inside.



ITEM	TOTAL LENGTH		☞	AVAILABLE
	in	mm		
689AR	6-3/4"	171.4	1	On Request

**REPLACEMENT BLADES**



**5**  
PIECES



- Made of SK4 steel.
- Includes dispenser/plastic.



ITEM	WIDTH	THICKNESS	☞	AVAILABLE

**UTILITY KNIFE**



- Strap-cutting slot without extending the blade.
- Non-slip grip with blade storage in the handle.
- Includes 6 blades.
- Meets GGG-K-494C standard.



ITEM	TOTAL LENGTH		☞	AVAILABLE
	in	mm		
NF6	6"	150	1	On Request

## KNIVES

### UTILITY KNIFE



- Classic knife design with 4 locking positions.
- Meets GGG-K-494C standard.



ITEM	in	TOTAL LENGTH	mm	⊞	AVAILABLE
NF7	7"		180	1	On Request

### REPLACEMENT BLADES FOR UTILITY KNIVES



REPNF5



REPNF6



REPN100



- Plastic case.
- Ideal for cutting strapping, cardboard, vinyl, plastic, carpets.

ITEM	DESCRIPTION	⊞	AVAILABLE
REPNF5	5 blades	1	On Request
REPNF6	10 blades	24	On Request
REPN100	100 blades	8	On Request

### METAL PRECISION KNIFE WITH GRIP COATING



NEX1



REX5



- Aluminum alloy handle with plastic cover.
- Includes 5 interchangeable blades.
- Ideal for cutting paper, plastic, fabric, metal sheets, and acetate film.
- SK5 steel blade.



ITEM	DESCRIPTION	TOTAL LENGTH	WIDTH BLADE	⊞	AVAILABLE
NEX1	Aluminum Handle	6"	6	6	On Request

### Replacement blades

ITEM	BLADES	BLADE LENGTH	BLADE MATERIAL	HARDNESS	⊞	AVAILABLE
REX5	5 blades	37 mm	SK5	50HV	1	On Request

### MULTI-TOOL



21 IN ONE



- Stainless steel.

Functions	Quantity	Functions	Quantity
Can opener	1	Magnifying glass	1
Plier	1	Tooth pick	1
Big knife, small knife	2	Tweezers	1
Corkscrew wine opener	1	Fish scaler	1
Bottle opener	1	Hook remover	1
Big flat screwdriver, middle flat screwdriver, small flat screwdriver and Phillips screwdriver	4	Ruler	1
Nail cleaner, File	1	Leather punch	1
Keychain	1	Saw	1
		Scissor	1

ITEM	FUNCTIONS	⊞	AVAILABLE
120530	21	1	On Request

**WOOD CHISELS**

**PROFESSIONAL WOOD CHISEL**



F01

WOOD CHISEL SET	
ITEM	JF03
PIECES	3
PACKING	
☞	1

- Full tang design with reinforced strike zone for hammering.
- For use on both hard and soft woods.

ITEM	BLADE WIDTH	BLADE LENGTH	☞	AVAILABLE	On Request
F014	1/4"	5-2/3"	1	On Request	•
F038	3/8"	5-2/3"	1	On Request	•
F012	1/2"	5-2/3"	1	On Request	•
F058	5/8"	5-2/3"	1	On Request	•
F034	3/4"	5-2/3"	1	On Request	•
F01	1"	5-2/3"	1	On Request	•
F0114	1-1/4"	5-2/3"	1	On Request	•
F0112	1-1/2"	5-2/3"	1	On Request	•
F02	2"	5-2/3"	1	On Request	•

**PROFESSIONAL WOOD CHISEL**



FF-1

WOOD CHISEL SET	
ITEM	J3F
PIECES	3
PACKING	
☞	1

- For use on both hard and soft woods.

ITEM	BLADE WIDTH	BLADE LENGTH	☞	AVAILABLE	On Request
FF-1/4	1/4"	3"	3	✓	•
FF-3/8	3/8"	3"	3	On Request	•
FF-1/2	1/2"	3"	3	On Request	•
FF-5/8	5/8"	3"	3	✓	•
FF-3/4	3/4"	3"	3	✓	•
FF-7/8	7/8"	3"	3	On Request	•
FF-1	1"	3"	3	On Request	•
FF-1 1/4	1-1/4"	3"	3	On Request	•
FF-1 1/2	1-1/2"	3"	3	On Request	•

**CARVING CHISEL**

**MANUAL CARVING CHISEL SET**



- Pre-sharpened, ready to use.
- Slim handle for greater precision.

ITEM	PIECES	☞	AVAILABLE
120050	6	1	✓



**FILES**

**HALF-ROUND FILES WITH BI-MATERIAL HANDLE**

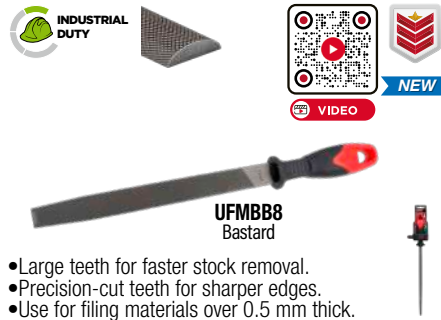

UFMBB8 Bastard

- Large teeth for faster stock removal.
- Precision-cut teeth for sharper edges.
- Use for filing materials over 0.5 mm thick.

ITEM	UFMBB8	UFMBB10	UFMBB12
LENGTH	8"	10"	12"
WIDTH	49/64"	61/64"	1-9/64"
TYPE OF FILE	Bastard	Bastard	Bastard
☞	1	1	1
AVAILABLE	On Request	On Request	On Request

**HALF-ROUND FILES WITH PLASTIC HANDLE**



120295 Rasp



120283 Bastard

- Triangular teeth for rough cutting and heavy stock removal.
- For use on wood, aluminum, and plastic.

- Large teeth for faster stock removal.
- For filing materials over 0.5 mm thick.

ITEM	120294	120295	120282	120283	120306
LENGTH	6"	8"	6"	8"	12"
WIDTH	9/16"	13/16"	5/8"	13/16"	1-3/16"
FILE TYPE	Rasp	Rasp	Bastard	Bastard	Bastard
☞	6	6	6	6	6
AVAILABLE	✓	✓	On Request	✓	✓

## FILES

### FLAT FILES WITH BI-MATERIAL HANDLE



### FLAT FILES WITH PLASTIC HANDLE



**UFPBB8**  
Bastard

**UFPMB8**  
Smooth

**120286**  
Bastard

- Large teeth for heavier stock removal.
- Precision-cut teeth for sharper edges.
- Use for filing material thicker than 0.5 mm.

- Smaller teeth for fine finishing.
- Precision-cut teeth for sharper edges.
- Use for filing material thinner than 0.5 mm.

- Large, coarse teeth for aggressive stock removal.
- Use for filing material thicker than 0.5 mm.

ITEM	UFPBB6	UFPBB8	UFPBB10	UFPBB12	UFPMB8	UFPMB10	UFPMB12
LENGTH	6"	8"	10"	12"	8"	10"	12"
WIDTH	19/32"	11/16"	61/64"	1-9/64"	11/16"	61/64"	1-9/64"
FILE TYPE	Bastard	Bastard	Bastard	Bastard	Smooth	Smooth	Smooth
☞	1	1	1	1	1	1	1
AVAILABLE	On Request	On Request	On Request	On Request	On Request	On Request	On Request

ITEM	120285	120286	120338
LENGTH	6"	8"	12"
WIDTH	41/64"	51/64"	1-3/16"
FILE TYPE	Bastard	Bastard	Bastard
☞	6	6	6
AVAILABLE	On Request	✓	✓

### ROUND FILES WITH BIMATERIAL HANDLE



### ROUND FILES WITH PLASTIC HANDLE



### TRIANGULAR FILES WITH BIMATERIAL HANDLE



**UFRBB8**  
Bastard



**120288**



**UFTP8**

- Large teeth for heavy stock removal.
- Precision-cut teeth for sharper edges.
- Use for filing material thicker than 0.5 mm.

- Individual triangular teeth formed with a chisel.
- For wood, aluminum, lead, horse hooves, and other soft materials.
- For rough and coarse filing.

- For smoothing corners and weld beads.
- For sharpening acute angles.

ITEM	UFRBB8	UFRBB10	UFRBB12
LENGTH	8"	10"	12"
WIDTH	16/64"	11/32"	7/16"
FILE TYPE	Bastard	Bastard	Bastard
☞	1	1	1
AVAILABLE	On Request	On Request	On Request

ITEM	120287	120288
LENGTH	6"	8"
WIDTH	1/4"	9/32"
FILE TYPE	Bastard	Bastard
☞	6	6
AVAILABLE	On Request	✓

ITEM	UFTP6	UFTP7	UFTP8
LENGTH	6"	7"	8"
WIDTH	1/2"	9/16"	39/64"
FILE TYPE	Bastard	Bastard	Bastard
☞	1	1	1
AVAILABLE	On Request	On Request	On Request

### TRIANGULAR FILES WITH PLASTIC HANDLE



### CHAINSAW FILES WITH BI-MATERIAL HANDLE



**120290**



**120298**



**120292**  
Doble triangle



**UFMB88**

- For sharpening machetes, hoes, axes, handsaws, and saws.
- For handsaws and saws with 60° tooth angles.

- Single cut, double-sided teeth.
- For sharpening handsaws and saws with 60° tooth angles.
- Double-ended.

- Designed for sharpening chainsaw teeth.
- Special tooth design provides an enhanced cutting action.

ITEM	120289	120373	120290	120296	120297	120298	120291	120292	120293
LENGTH	6"	7"	8"	6"	7"	8"	6"	7"	8"
WIDTH	17/32"	39/64"	21/32"	1/2"	39/64	21/32"	17/32"	39/64"	21/32"
FILE TYPE	Heavy duty	Heavy duty	Heavy duty	Regular	Regular	Regular	Doble triangle	Doble triangle	Doble triangle
☞	6	6	6	6	6	6	6	6	6
AVAILABLE	✓	✓	✓	✓	✓	On Request	✓	✓	✓

ITEM	UFMB8316	UFMB8532	UFMB8732
LENGTH	8"	8"	8"
WIDTH	3/16"	5/32"	7/32"
☞	1	1	1
AVAILABLE	On Request	On Request	On Request

FILES

HALF ROUND FILES



URREA



**UFME8**  
Rasp



**UFMB8**  
Bastard



**UFMM8**  
Smooth

- Triangular teeth for coarse and rough cuts.
- Precision-cut teeth for sharper and more efficient filing.
- For use on wood, aluminum, and plastics.

- Large teeth for faster material removal.
- Precision-cut teeth for sharper performance.
- For filing material over 0.5 mm thick.

ITEM	UFME8	UFME10	UFME12	UFMB8	UFMB10	UFMB12	UFMM8	UFMM10	UFMM12
LENGTH	8"	10"	12"	8"	10"	12"	8"	10"	12"
WIDTH	49/64"	61/64"	1-9/64"	49/64"	61/64"	1-9/64"	49/64"	61/64"	1-9/64"
THICKNESS	7/32"	9/32"	5/16"	7/32"	9/32"	5/16"	7/32"	9/32"	5/16"
FILE	Rasp	Rasp	Rasp	Bastard	Bastard	Bastard	Smooth	Smooth	Smooth
⊞	12	12	6	12	12	6	12	12	6
AVAILABLE	On Request	On Request	On Request	On Request	On Request	On Request	On Request	On Request	On Request

HALF ROUND FILES



SURTEK



**120392**  
Rasp



**120302**  
Bastard



**120312**  
Smooth

- Triangular teeth for coarse and rough cuts.
- For use on wood, aluminum, and plastic.

- Large teeth for faster material removal.
- For filing material over 0.5 mm thick.

ITEM	120391	120392	120393	120394	120301	120302	120303	120304	120311	120312	120313	120314
LENGTH	6"	8"	10"	12"	6"	8"	10"	12"	6"	8"	10"	12"
WIDTH	9/16"	13/16"	1"	1-3/16"	5/8"	13/16"	1"	1-3/16"	5/8"	13/16"	1"	1-3/16"
FILE	Rasp	Rasp	Rasp	Rasp	Bastard	Bastard	Bastard	Bastard	Smooth	Smooth	Smooth	Smooth
⊞	6	6	6	6	6	6	6	6	6	6	6	6
AVAILABLE	On Request	On Request	On Request	On Request	On Request	On Request	On Request	On Request	On Request	On Request	On Request	On Request

FLAT FILES



URREA



**UFPB6**  
Bastard



**UFPM6**  
Smooth

- Large teeth for greater material removal.
- Precision-cut teeth for sharper performance.
- For filing material over 0.5 mm thick.

- Smaller teeth for fine finishing.

ITEM	UFPB6	UFPB8	UFPB10	UFPB12	UFPB14	UFPM6	UFPM8	UFPM10	UFPM12	UFPM14
LENGTH	6"	8"	10"	12"	14"	6"	8"	10"	12"	14"
WIDTH	19/32"	11/16"	61/64"	1-9/64"	1-3/8"	19/32"	11/16"	61/64"	1-9/64"	1-3/8"
THICKNESS	9/64"	5/32"	13/64"	7/32"	17/64"	9/64"	5/32"	13/64"	7/32"	17/64"
FILE	Bastard	Bastard	Bastard	Bastard	Bastard	Smooth	Smooth	Smooth	Smooth	Smooth
⊞	12	12	12	6	6	12	12	12	6	6
AVAILABLE	On Request	On Request	On Request	On Request	On Request	On Request	On Request	On Request	On Request	On Request

## FILES

### FLAT FILES



**120332**  
Bastard

- Large teeth for faster material removal.
- For filing material over 0.5 mm thick.



**120342**  
Smooth

- Smaller teeth for fine finishing.
- For filing material under 0.5 mm thick.



ITEM	120330	120331	120332	120333	120334	120335	120340	120341	120342	120343	120344	120358
LENGTH	4"	6"	8"	10"	12"	14"	4"	6"	8"	10"	12"	14"
WIDTH	31/64"	41/64"	51/64"	1"	1-3/16"	1-3/16"	31/64"	41/64"	51/64"	1"	1-3/16"	1-3/8"
FILE	Bastard	Bastard	Bastard	Bastard	Bastard	Bastard	Smooth	Smooth	Smooth	Smooth	Smooth	Smooth
⊘	6	6	6	6	6	6	6	6	6	6	6	6
AVAILABLE	On Request	On Request	On Request	On Request	On Request	On Request	On Request	On Request	On Request	On Request	On Request	On Request

### ROUND FILES



**UFRB6**  
Bastard

- Large teeth for faster stock removal.
- Precision-cut teeth for sharper performance.
- For filing material over 0.5 mm thick.



**UFRM8**  
Smooth

- Smaller teeth for fine finishing.
- For filing material under 0.5 mm thick.



ITEM	UFRB6	UFRB8	UFRB10	UFRB12	UFRM8	UFRM10	UFRM12
LENGTH	6"	8"	10"	12"	8"	10"	12"
DIAMETER	1/4"	16/64"	11/32"	7/16"	17/64"	23/64"	15/32"
FILE	Bastard	Bastard	Bastard	Bastard	Smooth	Smooth	Smooth
⊘	12	12	12	12	12	12	6
AVAILABLE	On Request	On Request	On Request	On Request	On Request	On Request	On Request

### ROUND FILES



**120352**  
Bastard

- Precision-ground teeth with uniform hardness and geometry.



**120361**  
Smooth

- Precision-ground teeth with uniform hardness and geometry.
- For circular openings or concave surfaces.
- Double-cut, tapered point.
- Fine filing.



ITEM	120350	120351	120352	120353	120354	120360	120361	120362	120363
LENGTH	4"	6"	8"	10"	12"	6"	8"	10"	12"
DIAMETER	3/16"	1/4"	9/32"	3/8"	1/2"	1/4"	9/32"	3/8"	1/2"
FILE	Bastard	Bastard	Bastard	Bastard	Bastard	Smooth	Smooth	Smooth	Smooth
⊘	6	6	6	6	6	6	6	6	6
AVAILABLE	On Request	On Request	On Request	On Request	On Request	On Request	On Request	On Request	On Request

**FILES**

**TRIANGULAR FILES**



**UFTP8**



**UFTR8**

**URREA**  
TOOL FOR PROFESSIONALS



- For filing down corners and weld spots.
- For sharpening acute angles

ITEM	UFTP6	UFTP7	UFTP8	UFTR6	UFTR7	UFTR8	UFTR10
LENGTH	6"	7"	8"	6"	7"	8"	10"
WIDTH	1/2"	9/16"	39/64"	7/16"	35/64"	37/64"	23/32"
FILE	Heavy duty	Heavy duty	Heavy duty	Regular	Regular	Regular	Regular
☞	12	12	12	12	12	12	12
AVAILABLE	On Request	On Request	On Request	On Request	On Request	On Request	On Request

**TRIANGULAR FILES**



**120372**  
Heavy duty



**120378**  
Regular



**120383**  
Doble triangle

**SURTEK**  
TOOL FOR PROFESSIONALS



- For sharpening machetes, knives, hoes, axes, shears, hand saws, and saw blades.
- For sharpening hand saws and saw blades with 60° tooth angles.

- Single cut, double-sided file.
- For sharpening hand saws and saw blades with 60° tooth angles.
- Double-ended.

ITEM	120368	120369	120370	120371	120372	120376	120377	120378	120381	120382	120383
LENGTH	4"	5"	6"	7"	8"	6"	7"	8"	6"	7"	8"
WIDTH	3/8"	1/2"	17/32"	39/64"	21/32"	1/2"	39/64"	21/32"	7/32"	39/64"	21/32"
FILE	Heavy duty	Heavy duty	Heavy duty	Heavy duty	Heavy duty	Regular	Regular	Regular	Doble triangle	Doble triangle	Doble triangle
☞	6	6	6	6	6	6	6	6	6	6	6
AVAILABLE	On Request	On Request	On Request	On Request	On Request	On Request	On Request	On Request	On Request	On Request	On Request

**CHAIN SAW ROUND FILES**



**UFS8532**

**URREA**  
TOOL FOR PROFESSIONALS



**CHAIN SAW ROUND FILES**



**120322**

**SURTEK**  
TOOL FOR PROFESSIONALS



**TINSMITH FILE**



**SURTEK**  
TOOL FOR PROFESSIONALS



- Designed for sharpening chainsaw teeth.
- Special tooth design provides enhanced cutting action.

- Designed for sharpening chainsaw teeth.

- Ideal for laminate and paint work.

ITEM	UFS8532	UFS8316	UFS8732
LENGTH	8"	8"	8"
WIDTH	5/32"	3/16"	7/32"
☞	12	12	12
AVAILABLE	On Request	On Request	On Request

ITEM	120320	120321	120322
LENGTH	8"	8"	8"
DIAMETER	5/32"	3/16"	7/32"
☞	6	6	6
AVAILABLE	On Request	On Request	On Request

ITEM	120399
LENGTH	14"
WIDTH	1-5/16"
☞	6
AVAILABLE	On Request

## HIGH SPEED STEEL TAPS



### HIGH SPEED STEEL TAPS

High speed steel screw taps have cutting edges along the tool, allowing it to create threading at high speeds with quick cuts and less torque, making exact pieces that perform better. Precision thread that deliver accurate results and better performance. The screw tap is a tool used to create or restore internal threading. There is a wide range of designs for different uses, depending on whether a blind or open thread is needed.

Taper screw taps are meant for creating new thread from scratch, while non-tapered versions are used for repairing existing threads.

### NOMENCLATURE FOR TAPS

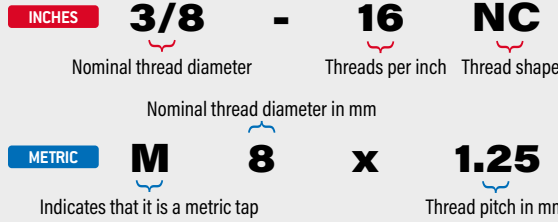

### THREAD SHAPES



Thread shape:  
**NC** standard thread.  
**NF** fine thread.  
**NS** special thread.  
**NPT** tapered pipe thread.

### TAPS AND DIES SET



123702

Content	Description	Qty.
Tap	1/4" - 1/8" (NC, NF, NPT)	11
	#4 - #12 (NC, NF)	6
	M3 x 0.5 - M12 x 1.75	10
Die	1/4" - 1/8" (NC, NF, NPT)	11
	#4 - #12 (NC, NF)	6
	M3 x 0.5 - M12 x 1.75	10
Accessories	Long adjustable handle tap wrench	1
	Long handle for die	1
	Screwdriver	1
	T-handle for tap	1
	Bar for T-handle	1
	Pitch gauge (SAE & Metric)	1

ITEM	PIECES	⊞	AVAILABLE
123702	60	1	On Request



123701

Content	Description	Qty.
Tap	1/4" - 1/8" (NC, NF, NPT)	11
	#4 - #12 (NC, NF)	6
	M3 x 0.5 - M12 x 1.75	10
Die	1/4" - 1/8" (NC, NF, NPT)	11
	#4 - #12 (NC, NF)	6
	M3 x 0.5 - M12 x 1.75	10
Accessories	Long adjustable handle tap wrench	1
	Long handle for die	1
	Screwdriver	1
	T-handle for tap	1
	Bar for T-handle	1
	Pitch gauge (SAE & Metric)	1

ITEM	PIECES	⊞	AVAILABLE
123701	40	1	On Request



### HIGH SPEED STEEL SCREW TAPS



JMC1/2-13

ITEM	DIAM HPP	FLUTES	TOTAL LENGTH	⊞	AVAILABLE
JMC1/8-40	1/8"-40NS	3	1-15/16"	1	✓
JMC3/16-24	3/16"-24NS	3	2-3/8"	1	✓
JMC1/4-20	1/4"-20NC	3	2-1/2"	1	✓
JMC5/16-18	5/16"-18NC	4	2-23/32"	1	✓
JMC3/8-16	3/8"-16NC	4	2-15/16"	1	✓
JMC1/2-13	1/2"-13NC	4	3-3/8"	1	✓
JMC5/8-11	5/8"-11NC	4	3-13/16"	1	On Request
JMC3/4-10	3/4"-10NC	4	4-1/4"	1	✓

### HIGH SPEED STEEL SCREW TAPS



MC1/2-13

- Manufactured from high-speed steel (HSS).
- Flute design for efficient chip removal.
- Creates internal threads in pre-drilled holes.
- Produces tapered threads for a wide variety of pipe connections.
- Ideal for automotive and mechanical industry application.

ITEM	DIAM HPP	FLUTES	TOTAL LENGTH	⊞	AVAILABLE
MC1/8-40	1/8"-40NS	3	1-15/16"	1	✓
MC3/16-24	3/16"-24NS	3	2-3/8"	1	✓
MC1/4-20	1/4"-20 NC	3	2-1/2"	1	✓
MC5/16-18	5/16"-18NC	4	2-23/32"	1	✓
MC3/8-16	3/8"-16NC	4	2-15/16"	1	✓
MC7/16-14	7/16"-14NC	4	3-5/32"	1	✓
MC1/2-13	1/2"-13NC	4	3-3/8"	1	✓
MC9/16-12	9/16"-12NC	4	3-19/32"	1	✓
MC5/8-11	5/8"-11NC	4	3-13/16"	1	✓
MC3/4-10	3/4"-10NC	4	4-1/4"	1	✓
MC7/8-9	7/8"-9NC	4	4-11/16"	1	✓
MC1-8	1"-8NC	4	5-1/8"	1	✓

### PLUG TAP



123570

- Each set includes a taper tap, a plug tap, and a bottoming tap.

ITEM	SIZE	⊞	AVAILABLE
123554	3/16", 24 NS	1	On Request
123558	1/4", 20 NC	1	On Request
123560	5/16", 18 NC	1	On Request
123562	3/8", 16 NC	1	On Request
123564	7/16", 14 NC	1	On Request
123566	1/2", 13 NC	1	On Request
123570	5/8", 11 NC	1	On Request
123572	3/4", 18 NC	1	On Request



### HIGH SPEED STEEL TAPS



123520

- Manufactured from high-speed steel (HSS).
- Flute design for efficient chip removal.
- Creates internal threads in pre-drilled holes.
- Produces tapered threads for a wide variety of pipe connections.

ITEM	SIZE	⊞	AVAILABLE
123500	1/8", 40 NS	1	On Request
123502	5/32", 32 NS	1	On Request
123504	3/16", 24 NS	1	On Request
123505	3/16", 32 NS	1	On Request
123508	1/4", 20 NC	1	On Request
123509	1/4", 28 NF	1	On Request
123510	5/16", 18 NC	1	On Request
123511	5/16", 24 NF	1	On Request
123512	3/8", 16 NC	1	On Request
123513	3/8", 24 NF	1	On Request
123514	7/16", 14 NC	1	On Request
123515	7/16", 20 NF	1	On Request
123516	1/2", 13 NC	1	On Request
123517	1/2", 20 NF	1	On Request
123518	9/16", 12 NC	1	On Request
123519	9/16", 18 NF	1	On Request
123520	5/8", 11 NC	1	On Request
123521	5/8", 18 NF	1	On Request
123522	3/4", 10 NC	1	On Request
123523	3/4", 16 NF	1	On Request
123528	1", 8 NC	1	On Request



**HIGH SPEED STEEL TAPS**

**PLUG TAPS SET**

GENERAL USE **INCHES**

**3** PIECES



123827

- **Straight Tap:** Designed to cut threads to the bottom of blind holes; commonly used for thread repair.
- **Plug Tap:** Most commonly used in through holes and blind holes with sufficient clearance at the bottom.
- **Taper Tap:** Acts as a guide when starting the threading process in a hole.

ITEM	SIZE	☞	AVAILABLE	ITEM	SIZE	☞	AVAILABLE
123820	5/32", 32NS	1	On Request	123824	3/8", 16NC	1	On Request
123821	3/16", 24NS	1	On Request	123825	7/16", 14NC	1	On Request
123822	1/4", 20NC	1	On Request	123826	1/2", 13NC	1	On Request
123823	5/16", 18NC	1	On Request	123827	5/8", 11NC	1	On Request

**MILLIMETER PLUG TAPS SET**

GENERAL USE **METRIC**

**3** PIECES



123865

- **Straight Tap:** Designed to cut threads to the bottom of blind holes; commonly used for thread repair.
- **Plug Tap:** Most commonly used in through holes and blind holes with sufficient clearance at the bottom.
- **Taper Tap:** Acts as a guide when starting the threading process in a hole.

ITEM	SIZE	☞	AVAILABLE	ITEM	SIZE	☞	AVAILABLE
123860	M4 x 0.7	1	On Request	123863	M8 x 1.25	1	On Request
123861	M5 x 0.8	1	On Request	123864	M10 x 1.5	1	On Request
123862	M6 x 1	1	On Request	123865	M12 x 1.75	1	On Request

**HIGH SPEED STEEL TAPS FOR PIPES**

GENERAL USE **INCHES**



123600

- Made of high-speed steel.
- Beveled teeth.
- Produces tapered threads for a wide variety of pipe connections.

ITEM	SIZE	☞	AVAILABLE
123600	1/8", 27 NPT	1	On Request
123601	1/4", 18 NPT	1	On Request
123602	3/8", 18 NPT	1	On Request
123603	1/2", 14 NPT	1	On Request
123604	3/4", 14 NPT	1	On Request
123605	1", 11.5 NPT	1	On Request
123606	1-1/4", 11.5 NPT	1	On Request
123607	1-1/2", 11.5 NPT	1	On Request

**PLUG TAP**

GENERAL USE **INCHES**



123880

- Each set includes a straight tap, a semi-tapered tap, and a tapered tap.

ITEM	SIZE	☞	AVAILABLE
123880	1/8", 27NPT	1	On Request
123881	1/4", 18NPT	1	On Request
123882	3/8", 18NPT	1	On Request
123883	1/2", 14NPT	1	On Request
123884	3/4", 14NPT	1	On Request

**PLUG TAP**

GENERAL USE **INCHES**



123811

- Made of high carbon steel.
- Flute design for efficient chip removal.
- Creates internal threads in pre-drilled holes.
- Produces tapered threads for a wide variety of pipe connections.

ITEM	SIZE	☞	AVAILABLE	ITEM	SIZE	☞	AVAILABLE
123802	3/16", 24NS	1	On Request	123809	7/16", 14NC	1	On Request
123815	3/16", 32NS	1	On Request	123816	7/16", 20NF	1	On Request
123803	1/4", 20NC	1	On Request	123810	1/2", 13NC	1	On Request
123804	1/4", 28NF	1	On Request	123817	1/2", 20NF	1	On Request
123805	5/16", 18NC	1	On Request	123818	9/16", 12NC	1	On Request
123806	5/16", 24NF	1	On Request	123819	9/16", 18NF	1	On Request
123807	3/8", 16NC	1	On Request	123811	5/8", 11NC	1	On Request
123808	3/8", 24NF	1	On Request	123813	3/4", 10NC	1	On Request

**METRIC PLUG TAP**

GENERAL USE **METRIC**



123838

- Made of high carbon steel.
- Flute design for efficient chip removal.
- Creates internal threads in pre-drilled holes.
- Produces tapered threads for a wide variety of pipe connections.

ITEM	SIZE	☞	AVAILABLE	ITEM	SIZE	☞	AVAILABLE
123831	M4 x 0.7	1	On Request	123840	M10 x 1	1	On Request
123832	M5 x 0.8	1	On Request	123836	M10 x 1.25	1	On Request
123833	M6 x 1	1	On Request	123837	M10 x 1.5	1	On Request
123834	M8 x 1	1	On Request	123838	M12 x 1.25	1	On Request
123835	M8 x 1.25	1	On Request	123839	M12 x 1.5	1	On Request

**STRAIGHT TYPE TAP HANDLE**

PROFESSIONAL USE



123900

- Reinforced steel body.
- Adjustable design for general-purpose use.
- Ideal for holding taps, reamers, screw extractors, and other square-shank tools.
- Body with baked enamel finish and knurled handles.

ITEM	SIZE	☞	AVAILABLE
123900	1/16" a 1/4"	1	On Request
123901	3/32" a 3/8"	1	On Request
123902	1/8" a 1/2"	1	On Request
123903	5/32" a 3/4"	1	On Request

**TAP HANDLE**

PROFESSIONAL USE



123904

- Sliding handle provides excellent leverage in confined spaces.
- Perfect for holding taps and screw extractors.
- Self-centering, adjustable jaws.

ITEM	SIZE	☞	AVAILABLE
123904	3/16"	1	On Request
123905	1/4"	1	On Request
123906	1/2"	1	On Request

## SCYTHE STONE

### SHARPENING STONE



128053

- Made of silicon carbide.
- Works with oil or water.
- Medium grit for sharpening and fine grit for removing nicks.

ITEM	HEIGHT X LENGTH	⊞	AVAILABLE
128050	4" x 1-3/4"	6	On Request
128053	6" x 2"	6	On Request
128054	8" x 2"	6	On Request



NEW



### SCYTHE STONE



- Made of aluminum oxide.
- Provides a sharp, long-lasting edge.
- Excellent for hand sharpening scythes, machetes, sickles, knives, and more.

ITEM	HEIGHT X LENGTH	⊞	AVAILABLE
128060	9" x 1-3/8"	6	On Request



## ALUMINUM OXIDE MOUNTED STONE BITS

### MOUNTED STONE BITS

- Mounted stone bits are small solid abrasives that come in different sizes and shapes, mounted on a steel shank.
- They can be used with air or power handheld tools with a straight spindle.
- They are used in die-stampers, for deburring cast pieces, retouching holes, etc.
- Also used for finishing interiors when the diameter is very small.
- They have high purity (99.8%).
- The fact that they grind cold allows them to be used for grinding tempered steels, vanadium, nickel and molybdenum.



### TYPE A MOUNTED STONE BITS SET



5 PIECES



Content	
A-1	
A-11	
A-15	
A-25	
A-39	

ITEM	PIECES	⊞	AVAILABLE
APM5A	5	1	✓



### TYPE B MOUNTED STONE BITS SET



5 PIECES



Content	
B-44	
B-52	
B-53	
B-97	
B-121	

ITEM	PIECES	⊞	AVAILABLE
APM5B	5	1	✓



### TYPE W MOUNTED STONE BITS SET



5 PIECES



Content	
W-144	
W-163	
W-188	
W-196	
W-220	

ITEM	PIECES	⊞	AVAILABLE
APM5W	5	1	On Request



### TYPE A



- Various shapes with 1/4" (6.3 mm) shank for general-purpose and machine applications.

ITEM	TYPE	DIAMETER	RPM'S	⊞	AVAILABLE
APMA1		A1	3/4"	19,800	10 On Request
APMA3		A3	1"	16,100	10 ✓
APMA5		A5	3/4"	30,500	10 On Request
APMA11		A11	7/8"	19,860	10 ✓
APMA24		A24	1/4"	76,500	10 ✓
APMA36		A36	1-5/8"	23,520	10 ✓



ALUMINUM OXIDE MOUNTED STONE BITS

TYPE B



• Various shapes with 1/8" (3.1 mm) shank for edge removal in small, hard-to-reach areas.

ITEM	TYPE	DIAMETER	RPM'S	Ø	AVAILABLE
APMB52		B52	13/32"	45,370	10 ✓
APMB81		B81	1/4"	60,000	10 On Request
APMB97		B97	1/8"	105,000	10 ✓
APMB53		B53	1/2"	45,370	10 ✓

MOUNTED STONES TYPE A FOR CASTING



1/4" shank

- Specially designed for stainless steel processing and the foundry industry.
- For foundry applications: composed of a blend of brown aluminum oxide and pink aluminum oxide.
- Ideal for grinding gray and ductile cast iron.

ITEM	TYPE	DIAMETER	RPM'S	Ø	AVAILABLE
APMA3F		A3	1"	16,100	10 ✓
APMW22F		W222	1"	15,900	10 ✓

TYPE W



• Cylindrical shapes with 1/4" shank for precision work, sharpening, and medium to heavy material removal.

ITEM	TYPE	DIAMETER	RPM'S	Ø	AVAILABLE
APMW188		W188	1/2"	30,370	10 ✓
APMW220		W220	1"	25,500	10 ✓
APMW222		W222	1"	15,900	10 ✓

MOUNTED STONE BITS FOR STAINLESS STEEL



- For stainless steel.
- Made with brown regular aluminum oxide.
- Designed for grinding and polishing hard steels and stainless steel.

ITEM	TYPE	DIAMETER	RPM'S	Ø	AVAILABLE
APMA1X		A1	3/4"	19,800	10 ✓
APMA3X		A3	1"	16,100	10 ✓
APMW222X		W222	1"	15,900	10 ✓

ABRASIVE WHEELS

ALUMINUM OXIDE GRINDING WHEELS



NEW



128006

- Ideal for foundry work, steel, and ferrous metals in general.
- Welds.
- For use with bench grinders.

ITEM	DIAMETER	GRAIN	THICKNESS	CENTER	RPM	Ø	AVAILABLE
128002	5"	36	3/4"	1/2"	5300	1	On Request
128004	6"	36	3/4"	1"	4400	1	On Request
128005	6"	60	3/4"	1"	4400	1	On Request
128006	6"	36	1"	1"	4400	1	On Request
128007	6"	60	1"	1"	4400	1	On Request
128010	8"	36	1"	1"	3300	1	On Request
128011	8"	60	1"	1"	3300	1	On Request

SILICON CARBIDE GRINDING WHEELS



NEW



128030

- Ideal for non-ferrous materials such as aluminum, bronze, copper, etc.
- Welds.
- For use with bench grinders.

ITEM	DIAMETER	GRAIN	THICKNESS	CENTER	RPM	Ø	AVAILABLE
128030	6"	60	3/4"	1"	4400	1	On Request
128032	6"	60	1"	1"	4400	1	On Request
128033	6"	80	1"	1"	4400	1	On Request

## HACKSAWS

### HIGH TENSION FIXED HACKSAW



- Aluminum body.
- Molded bi-material anti-slip handle.
- High-tension adjustment knob.



ITEM	BLADE	LENGTH	⊞	AVAILABLE
353F	12"	15-1/4"	1	On Request

### HIGH TENSION ERGONOMIC HACKSAW



- Aluminum body.
- Molded bi-material anti-slip handle.
- High-tension adjustment knob.



ITEM	BLADE	LENGTH	⊞	AVAILABLE
353AT	12"	16"	1	On Request

### HIGH TENSION LIGHTWEIGHT HACKSAW



- Single-piece injected plastic body.
- Bi-material anti-slip handle.
- Lightweight design.
- Straight tension.



ITEM	BLADE	LENGTH	⊞	AVAILABLE
354P	12"	16"	1	On Request

### BIMATERIAL HANDLE ADJUSTABLE HACKSAW



- Flat bar frame.
- Sliding bridge adjustable to three cutting positions.
- Bi-material handle.
- Thumb screw for blade tension adjustment.
- Straight tension.



ITEM	BLADE	LENGTH	⊞	AVAILABLE
352	8", 10" y 12"	15-1/2"	1	On Request

### HIGH-TENSION ERGONOMIC HACKSAW FRAME



NEW



- Aluminum body.
- Ergonomic handle.
- High-tension adjustment knob.



ITEM	BLADE	LENGTH	⊞	AVAILABLE
17AT	12"	17"	3	On Request

### HIGH-TENSION HACKSAW FRAME



- Aluminum body.
- High-tension adjustment knob.



ITEM	BLADE	LENGTH	⊞	AVAILABLE
17N	12"	17"	3	On Request

### HACKSAW FRAME ADJUSTABLE



- 3/16" x 3/4" flat bar frame.
- Sliding bridge adjustable to three cutting positions.
- Thumb screw for blade tension adjustment.



ITEM	BLADE	LENGTH	⊞	AVAILABLE
17	10" & 12"	17"	3	On Request

### ADJUSTABLE HACKSAW FRAME WITH POLYPROPYLENE HANDLE



NEW



- Flat bar frame.
- Sliding bridge adjustable to three cutting positions.
- Polypropylene handle with double reinforcement.
- Anti-slip grip coating on handle.
- Thumb screw for blade tension adjustment.
- Straight tension.
- Linear blade alignmen.



ITEM	BLADE	LENGTH	⊞	AVAILABLE
17A	10" & 12"	17"	3	On Request

**HACKSAWS**

**12" MINI HACKSAW FRAME**



- Bi-metal hacksaw.
- Aluminum and TPR handle.
- Adjustable for 10" and 12" blades.
- 24 TPI blade.
- Quick blade change.

ITEM	BLADE	LENGTH	⊞	AVAILABLE
352M	10" & 12"	12"	1	On Request

**BI-METAL SAW BLADES**



**10**  
PIECES

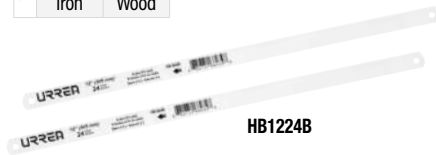

- Manufactured with 8% cobalt.
- Flexible material prevents breakage during use.

PRICE PER PIECE

ITEM	LENGTH	TEETH PER INCH	⊞	AVAILABLE
HB1218B	12"	18 DPP	10	✓
HB1224B	12"	24 DPP	10	✓

**HACKSAW BLADES BIMATERIAL**



**2**  
PIECES



- Manufactured from M2 steel.
- Flexible material prevents breakage during use.
- Heat-treated for increased hardness.

BLISTER PRICE WITH 2 PIECES

ITEM	LENGTH	TEETH PER INCH	⊞	AVAILABLE
SBM182	12"	18 DPP	1	On Request
SBM242	12"	24 DPP	1	On Request

**HACKSAW FRAME JUNIOR**



- Polypropylene handle.

ITEM	BLADE	LENGTH	⊞	AVAILABLE
120067	6"	6"	3	On Request

**12" MINI HACKSAW FRAME**



- Aluminum body.
- Adjustable blade tension system.
- Ideal for cutting in hard-to-reach areas.

ITEM	BLADE	LENGTH	⊞	AVAILABLE
120068	10" y 12"	12"	3	On Request

**BI-METAL SAW BLADES**



**50**  
PIECES



- Made from M2 steel.
- Flexible material prevents breakage during use.
- Heat-treated for greater hardness.

PRICE PER PIECE

ITEM	LENGTH	TEETH PER INCH	⊞	AVAILABLE
SBM1850	12"	18 DPP	50	\$23
SBM2450	12"	24 DPP	50	\$23

**HACKSAW BLADE, HIGH SPEED STEEL**



**10**  
PIECES



- Made from high-speed steel.

PRICE PER PIECE

ITEM	LENGTH	TEETH PER INCH	⊞	AVAILABLE
SAV18	12"	18 DPP	10	On Request
SAV24	12"	24 DPP	10	On Request

**COPING SAW WITH BI-MATERIAL, NON-SLIP HANDLE**



- Includes 5 blades.
- Durable metal frame.
- Non-slip bi-material handle.

ITEM	BLADE	LENGTH	⊞	AVAILABLE
120069	6"	6"	1	On Request

## HANDSAWS

### 3-SIDED TOOTH HANDSAW WITH BIMATERIAL HANDLE



- Suitable for cutting softwood, hardwood, and drywall.
- Triple-ground crosscut tooth design.
- TPE coating protects the blade against wear and rust.
- ABS/TPE bi-material handle with aluminum insert.

ITEM	BLADE LENGTH	BLADE THICKNESS	☞	AVAILABLE
34014	14"	0.85 mm	1	On Request
34016	16"	0.85 mm	1	On Request
34018	18"	0.85 mm	1	On Request
34020	20"	0.85 mm	1	On Request
34022	22"	0.85 mm	1	On Request



### TRIPLE EDGE AND COATING HANDSAW



- Blade made of hardened and polished SK5 steel.
- Full blade coated with TPE.

ITEM	BLADE LENGTH	BLADE THICKNESS	☞	AVAILABLE
120205	22"	1 mm	4	On Request
120206	24"	1 mm	4	On Request



### TRIPLE EDGE WOOD HANDLE HANDSAW



- Blade made of hardened and polished high-carbon steel.
- Reinforced steel back.
- Designed for fine cutting of medium-hard materials, moldings, plywood, and plastics.

ITEM	BLADE LENGTH	BLADE THICKNESS	☞	AVAILABLE
120245	18"	0.90 mm	4	On Request
120246	20"	0.90 mm	4	On Request
120247	22"	0.90 mm	4	On Request
120248	24"	0.90 mm	4	On Request
120249	26"	0.90 mm	4	On Request



### BACK SAW HANDSAW



- Blade made of hardened and polished high-carbon steel.
- Kiln-dried wooden handle.

ITEM	BLADE LENGTH	BLADE THICKNESS	☞	AVAILABLE
120226	10"	0.90 mm	4	On Request
120227	12"	0.90 mm	4	On Request
120228	14"	0.90 mm	4	On Request



### DRYWALL SAW



- SK5 steel blade.
- Ergonomic, non-slip bi-material handle.
- Blade made of hardened and polished high-carbon steel.

ITEM	BLADE LENGTH	BLADE THICKNESS	☞	AVAILABLE
120900	9"	0.70 mm	12	On Request





CLASS	TYPE	PAGE	BRAND	
			URREA	SURTEK
Sweep	Brooms	566	•	•
	Pitchforks	566		•
	Rake	568		•
Cut / prune	Axes	569	•	•
	Bow saws	569		•
	Tree pruners	569		•
	Fruit collector	571		•
	Machetes	571		•
	Pruning saw	571		•
	Two-handed pruning shears	572		•
	Hose pvc cutter	573		•
	One-handed pruning shears	573		•
	Scratch	Hoes	574	
Hole diggers		574		•
Garden tools		575		•
Screapers		575		•
Fumigate	Fumigators	576		•
Water	Irrigation accessories	577		•
	Garden hoses	582	•	•

[usa.urrea.com](http://usa.urrea.com)

We are constantly improving our products, that is why the information, characteristics and availability of them can change without prior notice.

## FORGED FORKS

### LONG HANDLE ONE-PIECE FORGED MANURE FORKS



54" wood handle.

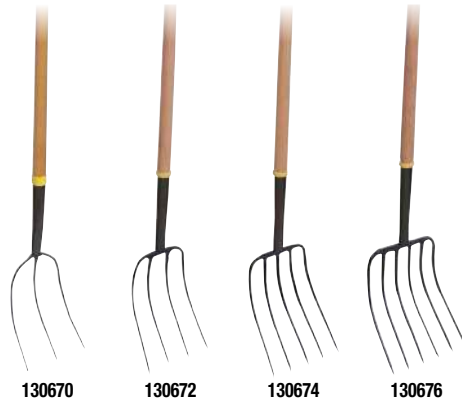
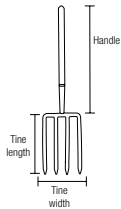

- Head made of one-piece forged steel for superior strength and durability.
- Reinforced steel ferrule with crimped ring for extra support and long service life.
- Long handle design provides greater leverage and easier lifting of loose materials with less effort.

**BULK**

ITEM	130670	130672	130674	130676
TINES	3	4	5	6
TINE WIDTH	7-1/2"	8-1/2"	9"	10"
TINE LENGTH	10"	14-1/2"	14-1/2"	14-1/2"
HANDLE LENGTH	54"	54"	54"	54"
⊕	3	3	3	3
AVAILABLE	✓	✓	✓	On Request

## LEAF RAKES

### CURVED REINFORCED PLASTIC LEAF RAKES WITH FIBERGLASS HANDLE



**NEW**



Long handle.



**26 TINES**



ESP26F



**22 TINES**



ESP22F

- Polypropylene head, 20% more flexible and impact-resistant for longer durability.
- Lightweight fiberglass handle resists weathering and outdoor conditions.
- Soft comfort grip provides better control and comfort during use.
- Offers 50% higher UV resistance for extended service life.

**BULK**

ITEM	ESP26F	ESP22F
TINES	26	22
TINE TYPE	Straight	Straight
HEAD WIDTH	24"	21.6"
HANDLE LENGTH	48"	48"
DIAMETER	7/8"	7/8"
⊕	1	1
AVAILABLE	On Request	On Request

### REINFORCED STRAIGHT METAL LEAF RAKES



**NEW**



**44 TINES**



130550



**24 TINES**



130597



**22 TINES**



130595



**18 TINES**



130594

- High-carbon steel tines provide superior strength and wear resistance.
- Built-in tension bar keeps tines securely in position during use.
- Reinforced twisted-tine design increases rigidity and durability.
- High-carbon steel head with lightweight aluminum handle for easier handling and reduced fatigue.
- High-carbon steel head with lightweight aluminum handle for easier handling and reduced fatigue.
- High-carbon steel head with lightweight aluminum handle for easier handling and reduced fatigue.

**BULK**

ITEM	130550	130597	130595	130594
TINES	44	24	22	18
TINE TYPE	Straight	Straight	Straight	Straight
HEAD WIDTH	24"	24"	22"	18"
HANDLE LENGTH	48"	48"	48"	48"
DIAMETER	1-1/4"	15/16"	7/8"	7/8"
⊕	6	6	6	6
AVAILABLE	✓	On Request	On Request	On Request



**LEAF RAKES**

**CURVED METAL LEAF RAKES**



**22 TINES**

**ROUNDED TINES**



**130596**



**22 TINES**



**130590**



**20 TINES**



**130592**

- High-carbon steel tines ensure excellent strength and long-lasting performance.
- Durable hardwood handle provides a natural feel and comfortable grip.
- Curved head design improves leaf collection efficiency and reduces clogging.
- Ideal for raking leaves, grass, and light garden debris.

**BULK**

ITEM	130596	130590	130592
TINES	22	22	20
TINE TYPE	Round	Straight	Straight
HEAD WIDTH	46 cm	46 cm	43 cm
HANDLE LENGTH	18-7/64"	18-7/64"	17"
DIAMETER	7/8"	7/8"	7/8"
☞	6	3	3
AVAILABLE	On Request	On Request	On Request

**PROFESSIONAL PLASTIC LEAF RAKES**

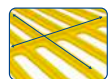

- Tines with reinforced veins.



- Great flexion resistance.



- Unique handle secure system.

**26 TINES**



**132051**

**22 TINES**



**132052**

- Strong hardwood handle provides durability and comfortable handling.
- Head allows easy handle replacement without drilling use a 1/2" metal strap or clamp for secure fit.
- Lightweight plastic design reduces fatigue during extended use.
- Ideal for collecting leaves and garden debris efficiently.

**BULK**

ITEM	132051	132053	132050	132052
TINES	26	26	22	22
TINE TYPE	Straight	Straight	Straight	Straight
HEAD WIDTH	24"	24"	21-11/16"	21-11/16"
HANDLE LENGTH	48"	48"	48"	48"
DIAMETER	7/8"	7/8"	7/8"	7/8"
COLOR				
☞	3	1	3	1
AVAILABLE	✓	✓	✓	✓

**STRAIGHT PLASTIC LEAF RAKES**

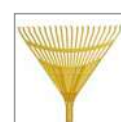

**20 TINES**



**130587**



**14 TINES**



**130585**

- Heavy-duty polypropylene head for superior durability and flexibility.
- Strong hardwood handle for reliable grip and long service life.
- Lightweight design makes sweeping easier and less tiring.
- Ideal for indoor and outdoor cleaning applications.

**BULK**

ITEM	130587	130585
TINES	20	14
TINE TYPE	Straight	Straight
HEAD WIDTH	20-1/8"	7-7/8"
HANDLE LENGTH	48"	48"
DIAMETER	7/8"	7/8"
☞	3	6
AVAILABLE	On Request	On Request

## LEAF RAKES

### STRAIGHT BI-MATERIAL LEAF RAKES



22 TINES



- Metal and plastic head combines high-impact resistance with durability.
- Sturdy hardwood handle ensures comfortable handling and long service life.
- Built-in tension bar keeps tines securely in position during use.
- Ideal for raking soil, leaves, and light debris in gardens and yards.



NEW

BULK

ITEM	130598
TINES	22
TINE TYPE	Straight
HEAD WIDTH	20"
HANDLE LENGTH	48"
DIAMETER	7/8"
☞	6
AVAILABLE	On Request

### STRAIGHT TINE RAKES



130650

- Forged steel head provides exceptional strength and long service life.
- Sturdy hardwood handle ensures comfortable grip and reliable handling.
- Tines designed specifically for gardening tasks such as leveling soil and removing debris.
- Ideal for garden beds, landscaping, and general yard maintenance.

BULK

ITEM	TINES	HANDLE LENGTH	☞	AVAILABLE
130650	14	60"	6	✓
130651	16	60"	6	✓

## RAKE

### STRAIGHT ROAD RAKE WITH FIBERGLASS HANDLE



Soft grip handle.



- Lightweight fiberglass handle resists weathering and outdoor conditions.
- Soft comfort grip provides better control and reduces hand fatigue.
- Patented insert fits precisely between head and handle for a durable, secure connection.
- Engineered to minimize vibrations, offering greater comfort and control during extended use.
- Ideal for spreading, leveling, and finishing asphalt or gravel surfaces.

BULK

ITEM	TINES	HANDLE LENGTH	☞	AVAILABLE
RASF16	16	60"	6	On Request

### BOW GARDEN RAKES



130656

- Forged steel head with bow design for greater strength and balanced performance.
- Sturdy hardwood handle provides durability and comfortable handling.
- Tines efficiently level soil, spread mulch, and remove garden debris.
- Ideal for landscaping, soil preparation, and general yard maintenance.

BULK

ITEM	TINES	HANDLE LENGTH	☞	AVAILABLE
130656	15	48"	6	✓
130657	17	54"	6	✓

### STRAIGHT ROAD RAKE



130653

- Forged steel head provides superior strength and long-lasting durability.
- Durable hardwood handle ensures firm grip and reliable performance.
- 1/4" thick tines deliver ideal rigidity for spreading and leveling asphalt.
- Designed for heavy-duty roadwork, paving, and maintenance applications.

BULK

ITEM	TINES	HANDLE LENGTH	☞	AVAILABLE
130653	14	60"	6	✓
130654	16	60"	3	✓

### RAKE MCLEOD



- Combines the functions of a rake and a hoe in one versatile tool.
- Ideal for building trails, clearing vegetation, and managing soil or debris.
- Widely used for wildfire prevention and firefighting operations.
- Heavy-duty construction ensures long-lasting performance in rugged outdoor conditions.

BULK

ITEM	TINES	HANDLE LENGTH	☞	AVAILABLE
RASTML	6	48"	1	On Request

**BOW SAW**

**BOW SAW**



120270



- Handle with knuckle guard prevents hand slippage for safer operation.
- Ideal for cutting green or damp wood quickly and efficiently.
- Quick-release blade system allows fast and easy blade changes
- Perfect for gardening, pruning, and outdoor maintenance tasks.



ITEM	SIZE	QTY	AVAILABLE
120270	21"	6	On Request
120271	24"	6	On Request

**BOW SAW REPLACEMENT**

**Replacement**

- Induction hardened.
- Precision edged saw.



120275



ITEM	FOR ITEM	QTY	AVAILABLE
120275	120270	1	On Request
120276	120271	1	On Request

**AXES**

**CHOPPING AXES**



AX9



AX28

- Forged high-carbon steel head with PTFE coating for superior resistance to corrosion, rust, and wear.
- Nylon, fiberglass, and steel alloy handle combines lightweight design with steel-like strength.
- TPR grip provides comfort and superior control with every swing.
- Optimized blade geometry for powerful diagonal cuts.
- Ideal for chopping medium and large logs efficiently.



ITEM	HEAD MATERIAL	SIZE	HANDLE	HEAD WEIGHT	HANDLE LENGTH	TOTAL LENGTH	QTY	AVAILABLE
AX9	Steel	9"	Fiberglass handle	1 lbs	9"	9"	1	On Request
AX28	Steel	28"	Fiberglass handle	2 lbs	28"	28"	1	On Request

**TREE PRUNERS**

**TREE PRUNERS**



- Hardened SK5 steel blade ensures maximum edge retention and long-lasting sharpness.
- Bypass cutting system delivers clean, precise cuts without damaging branches.
- Double-pulley mechanism reduces effort and increases cutting efficiency.
- Ideal for high-reach pruning and maintaining tall trees safely.



ITEM	LENGTH	QTY	AVAILABLE
130225	14"	1	On Request

**TREE PRUNERS EXTENSION**



- Telescopic aluminum handle for adjustable reach, lightweight handling, and improved maneuverability.

ITEM	LENGTH	QTY	AVAILABLE
CAB36	5-1/8" - 9-7/16"	3	On Request

**MICHIGAN-STYLE FORGED STEEL AXE WITH FIBERGLASS HANDLE**



- High-carbon steel head with dual heat treatment for a stronger, longer-lasting cutting edge.
- Fiberglass and TPR handle absorbs vibration and provides a comfortable, secure grip.
- Designed for cutting large logs and heavy wood with minimal effort.
- Ideal for forestry work, logging, and demanding outdoor applications.



ITEM	HEAD MATERIAL	HANDLE	HEAD WEIGHT	HANDLE LENGTH	TOTAL LENGTH	QTY	AVAILABLE
HMFV3 1/2	High Carbon Steel	Fiber Glass	3-1/2 lb	36"	36"	1	✓

**HUNTER'S AXE WITH FORGED STEEL HEAD AND FIBERGLASS HANDLE**



- High-carbon steel head with dual heat treatment provides a sharper, longer-lasting edge.
- Bi-material fiberglass handle enhances grip, comfort, and control during use.
- Balanced and lightweight design allows fast, precise cuts on smaller or finer wood.
- Ideal for camping, hunting, and light-duty wood chopping tasks



ITEM	HEAD MATERIAL	HANDLE	HEAD WEIGHT	HANDLE LENGTH	TOTAL LENGTH	QTY	AVAILABLE
HC1 1/2F	High Carbon Steel	Fiber Glass	1-1/2 lb	14"	14"	4	On Request

## AXES

### 3-1/2 LB MICHIGAN AXE



- Kiln-dried, polished, and lacquered hardwood handle for strength and durability.
- High-carbon steel head with dual heat treatment provides a sharper, longer-lasting cutting edge.
- Balanced design for efficient chopping of large logs and thick wood.
- Ideal for forestry work, logging, and heavy-duty outdoor applications.

**BULK**

ITEM	HEAD MATERIAL	HANDLE	HEAD WEIGHT	HANDLE LENGTH	TOTAL LENGTH	☞	AVAILABLE
HM3 1/2	High carbon steel	Wood	3-1/2 lb	36"	36"	2	✓

### FULL-HATCHET WITH FORGED STEEL HEAD AND WOODEN HANDLE



**NEW**



LE3.5M

- High-carbon steel head with dual heat treatment for a sharper and longer-lasting edge.
- Heavier and more robust design, ideal for felling large trees and heavy-duty cutting tasks.
- Polished hardwood handle provides strength, comfort, and shock absorption.
- Perfect for forestry work, logging, and demanding outdoor applications.

**BULK**

ITEM	HEAD MATERIAL	HANDLE	HEAD WEIGHT	HANDLE LENGTH	TOTAL LENGTH	☞	AVAILABLE
LE2.5M	High Carbon Steel	Wood	2-1/2 lb	36"	36"	2	✓
LE3M	High Carbon Steel	Wood	3 lb	36"	36"	2	✓
LE3.5M	High Carbon Steel	Wood	3-1/2 lb	36"	36"	2	✓
LE4M	High Carbon Steel	Wood	4 lb	36"	36"	2	✓

### HALF HATCHET WITH FORGED STEEL HEAD AND WOODEN HANDLE



**NEW**



LE3M

- High-carbon steel head with dual heat treatment provides a sharper, longer-lasting cutting edge.
- Ideal for precision tasks such as cutting and splitting medium-sized wood.
- Balanced weight and ergonomic design offer greater comfort during extended use.
- Durable hardwood handle ensures reliable performance and control.

**BULK**

ITEM	HEAD MATERIAL	HANDLE	HEAD WEIGHT	HANDLE LENGTH	TOTAL LENGTH	☞	AVAILABLE
ML3M	High Carbon Steel	Wood	3 lb	36"	36"	2	✓
ML3.5M	High Carbon Steel	Wood	3-1/2 lb	36"	36"	2	✓
ML4M	High Carbon Steel	Wood	4 lb	36"	36"	2	✓

### CAMP AXES



HC 1 1/2

- High-carbon steel head with dual heat treatment ensures a sharper, longer-lasting edge.
- Designed for fast, precise cuts on small or fine wood.
- Compact and well-balanced for easy handling and portability.
- Ideal for camping, hiking, and light-duty woodcutting tasks.

**BULK**

ITEM	HEAD MATERIAL	HANDLE	HEAD WEIGHT	HANDLE LENGTH	TOTAL LENGTH	☞	AVAILABLE
HC 1 1/4	High carbon steel	Wood	1-1/4 lb	14"	14"	4	On Request
HC 1 1/2	High carbon steel	Wood	1-1/2 lb	14"	14"	4	On Request

### FORGED STEEL MICHIGAN HEAD



**NEW**



- High-carbon steel head with dual heat treatment provides a sharper, longer-lasting cutting edge.

**BULK**

ITEM	HEAD MATERIAL	HANDLE	HEAD WEIGHT	HELVE LENGTH	TOTAL LENGTH	☞	AVAILABLE
M3 1/2	High Carbon Steel	N/A	3-1/2 lb	N/A	7-1/2"	4	On Request

### FORGED STEEL FULL HATCHET HEAD



**NEW**



LE3

- High-carbon steel head with dual heat treatment for a sharper and longer-lasting edge.

**BULK**

ITEM	HEAD MATERIAL	LABOR	HEAD WEIGHT	☞	AVAILABLE
LE2.5	High Carbon Steel	Complete	2-1/2 lb	4	✓
LE3	High Carbon Steel	Complete	3 lb	4	On Request
LE3.5	High Carbon Steel	Complete	3-1/2 lb	4	On Request
LE4	High Carbon Steel	Complete	4 lb	4	On Request

**MACHETES**

**MACHETES SURTEK**

Machetes are used in various sectors for manual work that a machine could not do, since these having a sharp edge, being light and small, can be used without major complications.

The most common uses of:

- Mow the grass
- Cut the sugar cane
- Prune plants
- Open trails
- Cut brush



Surtek has 3 different designs, available in different sizes.



The grip has 4 rivets that secure the handle to the blade and avoid accidents.

**YELLOW HANDLE MACHETES**



**130501**

Acapulqueño

- Ideal for cutting large, thick-stemmed plants such as sugar cane.



**130503**

Recto

- Versatile tool excellent for detailed cutting jobs like clearing weeds, grass, or small shrubs.



**130508**

Caguayano

- Heavy-duty and robust design, perfect for cutting hardwood, dense brush, or demanding forestry tasks.

**BULK**

ITEM	130494	130501	130502
BLADE	Laminated		
BLADE LENGTH	22"	24"	27"
DESIGN	Acapulqueño		
☞	1	1	1
AVAILABLE	On Request	On Request	On Request

ITEM	130495	130496	130503	130504	130505	130506	130507
BLADE	Laminated						
BLADE LENGTH	14"	16"	18"	20"	22"	24"	26"
DESIGN	Straight						
☞	1	1	1	1	1	1	1
AVAILABLE	On Request	On Request	On Request	On Request	On Request	On Request	On Request

ITEM	130497	130508
BLADE	Laminated	
BLADE LENGTH	24"	27"
DESIGN	Caguayano	
☞	1	1
AVAILABLE	On Request	On Request

**BLACK HANDLE DIE CUT MACHETES**



**130511**

Acapulqueño

- Ideal for cutting large, thick-stemmed plants such as sugar cane.



**130513**

Recto

- Versatile tool excellent for detailed cutting jobs like clearing weeds, grass, or small shrubs.



**130518**

Caguayano

- Heavy-duty and robust design, perfect for cutting hardwood, dense brush, or demanding forestry tasks.

**NEW**

**BULK**

ITEM	130511	130512
BLADE	Die cut	
BLADE LENGTH	24"	27"
DESIGN	Acapulqueño	
☞	1	1
AVAILABLE	On Request	On Request

ITEM	130498	130499	130513	130514	130515	130516	130517
BLADE	Die cut						
BLADE LENGTH	14"	16"	18"	20"	22"	24"	26"
DESIGN	Recto						
☞	1	1	1	1	1	1	1
AVAILABLE	On Request	On Request	On Request	On Request	On Request	On Request	On Request

ITEM	130500	130518
BLADE	Die cut	
BLADE LENGTH	24"	27"
DESIGN	Caguayano	
☞	1	1
AVAILABLE	On Request	On Request

**FRUIT COLLECTOR**

**FRUIT COLLECTOR**

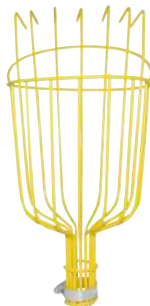

- Basket with coated wire and built-in claw for easy fruit picking and cutting.
- Soft foam pad cushions and protects harvested fruit from bruising.
- Compatible with CAB36 handle.
- Includes adjustable hose clamp for secure attachment.
- Ideal for harvesting fruits safely and efficiently without damaging branches.



ITEM	DIAMETER	☞	AVAILABLE
<b>130229</b>	5-3/4"	1	On Request

**PRUNING SAW**

**PRUNING SAW WITH FOLDING PLASTIC HANDLE**



- Triple-ground teeth provide three cutting edges per tooth, reducing friction and ensuring faster, smoother cuts.
- Ergonomic handle designed for a comfortable, secure grip that minimizes fatigue during extended use.
- Foldable design allows compact storage and easy portability.
- Ideal for pruning branches, shrubs, and general garden maintenance.

ITEM	BLADE LENGTH	☞	AVAILABLE
<b>120264</b>	12" / 30.4 cm	3	On Request

**PRUNING SAW WITH ROUNDED WOOD HANDLE**



- Triple-ground teeth, each with three cutting points, reduce friction and deliver faster, smoother cuts.
- Curved hardwood handle provides a natural, comfortable grip and better cutting angle.
- Durable steel blade designed for precision pruning and long-lasting sharpness.
- Ideal for cutting branches, shrubs, and general garden maintenance.

ITEM	BLADE LENGTH	☞	AVAILABLE
<b>120260</b>	12" / 30.4 cm	3	On Request
<b>120265</b>	14" / 35.5 cm	3	On Request

**NEW**

## SHEARS

### PRUNING SHEARS



TSF12

- Forged 5 mm thick blades, induction-hardened for superior edge retention and durability.
- Wooden handles with textured grip for better comfort and control.



130226

- Tubular handles with non-slip PVC grips provide comfort, control, and secure handling during use.



TSAG12

- Wooden handles with textured grip for enhanced comfort and control.
- Adjustable knob allows precise blade tension for different pruning needs.
- Plastic bumpers absorb impact, providing smoother operation.



TSSG12

- Wooden handles with textured grip for secure handling and reduced slippage.
- Adjustable knob ensures precise tension adjustment.
- Plastic bumpers soften impact for more comfortable operation.
- Serrated blade firmly grips branches for accurate, controlled cuts.



TSWG12

- Wooden handle with textured grip for improved comfort and control.
- Adjustable knob allows fine-tuning of blade tension for optimal performance.
- Plastic bumpers absorb shock and reduce impact for smoother operation.
- Wavy blade design holds branches firmly for clean, smooth cuts.



TSA12

- Adjustable wing nut designed for heavy-duty pruning tasks.
- Shock-absorbing bumper minimizes impact and reduces hand fatigue during use.



TS12

- Induction-hardened blade ensures maximum durability and performance under demanding conditions.



TS10

- Serrated blade grips branches firmly for accurate, controlled cuts.



NEW

BULK

ITEM	TSF12	130226	TSAG12	TSSG12	TSWG12	TSA12	TS12	TS10
BLADE LENGTH	12"	12"	12"	12"	12"	12"	12"	10"
TOTAL LENGTH	19-3/4"	21"	21-3/4"	24"	24"	24"	21"	19"
BLADE THICKNESS	13/64"	11/64"	5/32"	5/32"	9/64"	5/32"	11/64"	9/64"
☒	6	6	3	3	3	3	3	3
AVAILABLE	✓	✓	✓	✓	✓	✓	✓	On Request

### LOPPERS



TRAG21

- Soft grip handles provide a comfortable, secure hold for better control during pruning.



TRA21

Bumpers for smooth cutting.



130227

- Tubular handle with textured grip provides improved control, comfort, and weather resistance.



NEW

BULK

ITEM	TRAG21	TRA21	130227
HANDLE	Wood with grip 21"	Wood 21"	Tubular 21"
CUT CAPACITY DIAMETER	1-3/4"	1-1/2"	1-1/2"
☒	1	1	1
AVAILABLE	✓	✓	On Request

**PRUNING SHEARS**

**PRUNING SHEARS FOR AGRICULTURE**



**T25**

- Rounded tips prevent damage to fruit and delicate stems during harvesting.



**T14**

- Heavy-duty spring mechanism ensures quick and consistent reopening after each cut.



**T22**

- Slim blades allow easy access to tight spaces between clusters and branches.



- Designed for precision pruning and safe handling in agricultural applications.
- Lightweight construction reduces fatigue during prolonged use.
- Ideal for fruit picking, vineyard work, and greenhouse maintenance.

ITEM	T25	T14	T22
TYPE	Citrus	Straight for avocado	Curve for grapes
BLADE LENGTH	2-1/2"	1-1/8"	2-1/8"
TOTAL LENGTH	9-1/8"	5-3/8"	8"
☞	1	1	1
AVAILABLE	On Request	On Request	On Request

**ONE-HAND PRUNING SHEARS**



**T10**

- Blades twice as strong and durable as standard high-carbon steel blades.
- Bypass blade system delivers clean, precise cuts on green and live branches.



**T12**

- Blades twice as strong and durable as high-carbon steel for longer edge life.
- Anvil-style blade easily cuts through dry, dead, or thick branches with less effort.



**T26**

- 6" forged bypass blade delivers clean, delicate cuts on green stems and flowers.
- Slim blade design allows access to tight spaces between branches.



**T07**

- 8" forged bypass blade offers superior reach and cutting capacity.
- Curved ergonomic handle enhances comfort during extended use.



**T27**

- 6" forged bypass blade provides clean, precise cuts on green stems and branches.
- Curved ergonomic handle offers greater comfort and control during pruning.



ITEM	T10	T12	T26	T07	T27
TYPE	Floriculture	Small shrubs	Cuts green stems and flowers.	8" step slab	6" step slab
BLADE LENGTH	2-1/4"	1-1/2"	1-5/8"	2-3/4"	2-1/2"
TOTAL LENGTH	8-1/2"	8"	6"	8-5/8"	6-5/8"
☞	1	1	1	1	1
AVAILABLE	On Request	On Request	On Request	On Request	On Request

**HOSE PVC CUTTER**

**HOSE PVC CUTTER**



- SK5 steel blade ensures exceptional sharpness and long-lasting edge durability.
- Lightweight aluminum body provides strength and easy handling.
- Ideal for cutting thin-wall PVC hose and tubing cleanly and efficiently.
- Compact design allows one-handed operation for quick, precise cuts.



ITEM	CUT CAPACITY DIAMETER	TOTAL LENGTH	☞	AVAILABLE
121121	2"	10-1/2"	1	On Request



## HOES

### FORGED LANE HOES WITH FIBERGLASS HANDLE



Soft grip handle.



AZFL2

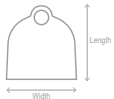

- Fiberglass handle reduces vibrations and offers superior weather resistance.
- Excellent balance between light weight, durability, and strength under extreme conditions.
- Patented insert ensures a strong, durable connection between head and handle.
- Ideal for digging, shaping soil, and general agricultural or landscaping work.



NEW

BULK

ITEM	LANE	BLADE WIDTH	BLADE HEIGHT	☞	AVAILABLE
AZFL0	No. 0	6-3/4"	4-3/8"	2	On Request
AZFL1	No. 1	7-1/2"	4-3/8"	2	On Request
AZFL2	No. 2	8"	4-3/8"	2	On Request
AZFL3	No. 3	8-5/8"	4-3/8"	2	On Request

### FORGED LANE HOES WITH METAL HANDLE



Soft grip handle.



AZMLO

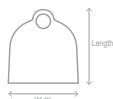

- Metal handle withstands higher loads and stress compared to wood.
- Ideal for heavy-duty applications requiring superior strength, durability, and rigidity.
- Designed to perform in tough, high-wear conditions.
- Perfect for construction, farming, and industrial use



NEW

Mango de 54"

BULK

ITEM	LANE	BLADE WIDTH	BLADE HEIGHT	☞	AVAILABLE
AZMLO	No. 0	6-3/4"	4-3/8"	2	On Request
AZML1	No. 1	7-1/2"	4-3/8"	2	On Request
AZML2	No. 2	8"	4-3/8"	2	On Request
AZML3	No. 3	8-5/8"	4-3/8"	2	On Request

### SHORT-HANDLE HOE WITH WOODEN HANDLE



Soft grip handle.

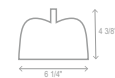

- Ideal for loosening soil, turning earth, and working between tomato plants in tight spaces.
- 16" short handle provides excellent control and maneuverability in garden beds.
- Durable wooden handle ensures comfort and long-lasting use.
- Perfect for vegetable gardens and precision soil work.



NEW



Mango de 16"

BULK

ITEM	BLADE WIDTH	BLADE HEIGHT	☞	AVAILABLE
130055	6-1/4"	4-3/8"	4	✓

## POST HOLE DIGGERS

### POST HOLE DIGGERS WITH FIBERGLASS HANDLE



Soft grip handle.

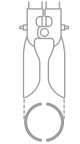

6-1/2"



CAVF48

- For hard and compact soils.

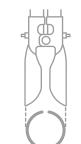

6"



CAVF45

- Designed for deep and durable digging applications.



NEW

BULK

- Fiberglass handle reduces vibrations and offers superior weather resistance.
- Excellent balance of light weight, durability, and strength under extreme working conditions.

ITEM	CAVF48	CAVF45
HANDLE LENGTH	48"	45"
PATTERN	Hercules	Agricola
MAXIMUM OPENING	6-1/2"	6"
☞	2	2
AVAILABLE	On Request	On Request

### METAL HANDLE POST HOLE DIGGERS



Soft grip handle.

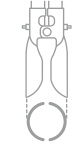

6-1/2"



CAV48

- For hard and compact soils.

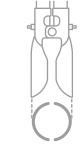

6"



CAV45

- Designed for deep and durable digging applications.



BULK

- Metal handle withstands higher loads and stress than wooden handles.
- Ideal for heavy-duty applications requiring maximum strength, durability, and rigidity especially in tough, high-wear conditions.

ITEM	CAV48	CAV45
HANDLE LENGTH	48"	45"
PATTERN	Hercules	Agricola
MAXIMUM OPENING	6-1/2"	6"
☞	2	2
AVAILABLE	✓	✓



**POST HOLE DIGGERS**

**WOOD HANDLE POST HOLE DIGGERS**



- Designed for hard and compact soils.
- Suitable for soft or medium soils requiring small to medium-sized holes.
- Ideal for deep and durable digging applications.
- Perfect for gardening, landscaping, and small farm work.

**BULK**

ITEM	130554	130553	130552	130551
HANDLE LENGTH	48"	48"	48"	42"
PATTERN	Hercules	Atlas	Agricola	Gardener
MAXIMUM OPENING	6-1/2"	6"	6"	6"
☞	2	2	2	2
AVAILABLE	✓	✓	✓	✓

**SCRAPERS**

**SCRAPERS WITH WOOD HANDLE AND PLASTIC Y-GRIP**



- Reinforced plastic cuff design
- High impact



130704

- Forged steel head provides superior strength and wear resistance.
- Ideal for heavy-duty cleaning, surface restoration, soil preparation, and removing asphalt or roots.
- Wooden handle with plastic Y-grip offers comfort and firm control during demanding work.

**BULK**

ITEM	HANDLE LENGTH	BLADE WIDTH	☞	AVAILABLE
130704	42"	4"	3	✓
130705	42"	7"	3	✓

**GARDEN TOOLS**

**GARDEN TOOLS SET**



**4 PIEZAS**



- Handles fitted with metal ferrules for added strength and durability.
- Anti-rust coating protects tools from corrosion and extends service life.
- Lightweight and balanced design for comfortable use in gardening tasks.
- Ideal for planting, soil preparation, and general garden maintenance.

ITEM	PIECES	☞	AVAILABLE
130239	4	1	✓

**GARDEN TOOLS SET**



**NEW**



130230 130231 130232 130233

- Handles fitted with metal ferrules for added strength and durability.
- Anti-rust coating protects tools from corrosion and extends service life.

ITEM	130230	130231	130232	130233
TOOL	Shovel-Spoon	Trasplanter	Cultivator	Weeder
HANDLE LENGTH	6"	6"	6"	6"
☞	1	1	1	1
AVAILABLE	On Request	On Request	On Request	On Request

**SCRAPERS WITH WOOD HANDLE LONG**



130701

- Forged steel head offers exceptional strength and superior wear resistance.
- Ideal for heavy-duty cleaning, surface restoration, soil preparation, and removing asphalt or roots.
- Extended wooden handle provides greater reach and leverage for demanding applications.

**BULK**

ITEM	HANDLE LENGTH	BLADE WIDTH	☞	AVAILABLE
130701	54"	4"	1	On Request
130703	54"	7"	1	On Request

## PUMP SPRAYERS

### MANUAL BACKPACK SPRAYERS



FM012



FM016



FM020



NEW

- Metal lance for durability and precise spraying.
- Adjustable nozzles for different spray patterns and applications.
- Reinforced, padded shoulder straps provide comfort and secure fit during extended use.
- Ideal for agricultural, gardening, and pest-control applications.



ITEM	CAPACITY		☐	AVAILABLE	ITEM	CAPACITY		☐	AVAILABLE	ITEM	CAPACITY		☐	AVAILABLE
	L	GAL				L	GAL				L	GAL		
FM012	12	3.1	1	On Request	FM016	16	4.2	1	On Request	FM020	20	5.2	1	On Request

### PROFESSIONAL SPRAYERS WITH ACCESSORIES



FU3



130404

- Brass Spear



FU5



FU8



FU10



NEW

- Stainless steel lance provides durability and corrosion resistance.
- Translucent polyethylene tank allows easy monitoring of liquid levels.
- Wide-mouth cap for quick and convenient filling.
- Anti-clog filter prevents nozzle blockage and ensures consistent flow.
- Adjustable spray control for precise application on different surfaces.



ITEM	ACCESSORY	CAPACITY		☐	AVAILABLE	ITEM	ACCESSORY	CAPACITY		☐	AVAILABLE	ITEM	ACCESSORY	CAPACITY		☐	AVAILABLE
		L	GAL					L	GAL					L	GAL		
FU3	Metallic	3	0.7	1	On Request	FU5	Metallic	5	1.3	1	On Request	FU10	Metallic	10	2.6	1	On Request
130404	Metallic	3.8	1	1	✓	FU8	Metallic	8	2.1	1	On Request						

### DOMESTIC SPRAYERS



130408



130409



- Brass nozzle provides durability and a consistent, fine spray pattern.
- Locking trigger on top of the handle allows continuous spraying without fatigue.
- Lightweight design ideal for home, garden, and general cleaning applications.



ITEM	CAPACITY		☐	AVAILABLE
	L	GAL		
130408	1	0.26	1	On Request
130409	1.5	0.4	1	On Request

### MULTIPURPOSE PLASTIC SPRAYER



130400



- Graduated bottle in milliliters and ounces for precise measuring and mixing.
- Adjustable spray nozzle allows control of atomization from fine mist to direct stream.
- Lightweight plastic construction for comfort and easy handling.
- Ideal for home, garden, and cleaning applications.

BULK

ITEM	CAPACITY		☐	AVAILABLE
	L	GAL		
130400	1	0.26	1	On Request

**IRRIGATION ACCESSORIES**

**IRRIGATION ACCESSORIES**

The adapters are made of materials resistant to pressure and oxidation. With them you can convert single or double output.

Surtek line sprinklers are adjustable and are available in 1 and 2 ways. The nozzles are metallic, with this we avoid the premature degradation of the material.

**TWO WAY BRONZE HOSE CONNECTOR**



- Solid bronze body provides high durability and corrosion resistance.
- 3/4" inlet and outlet compatible with standard garden hoses.
- Swivel nut design allows quick and easy installation.
- Ideal for splitting water flow between two hoses or accessories.

ITEM	WIDTH	DIMENSIONS LENGTH	HIGH	⊞	AVAILABLE
130334	4-1/2"	2-11/16"	1-11/16"	6	✓

**CHROME PLATED 2 WAY HOSE CONNECTOR WITH SHUT-OFF**



- Chrome-plated metal body provides durability and corrosion resistance.
- 3/4" inlet and outlet compatible with standard garden hose fittings.
- Ideal for connecting watering accessories and ensuring a secure, leak-free seal.

ITEM	WIDTH	DIMENSIONS LENGTH	HIGH	⊞	AVAILABLE
130333	4-5/16"	2-11/16"	1-1/2"	12	✓

**PRINKLERS**

Pulsating sprinklers can water specific areas with adjustable coverage from 90° to 360°. Provide even water distribution and adjustable range for efficient irrigation.

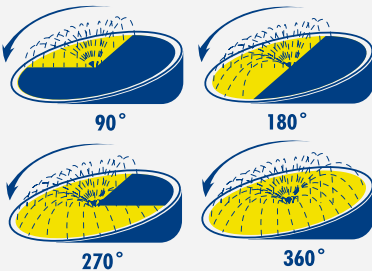

Pressure	Radio	Consumption
PSI	m	l/min
30	36	3.7
40	39.4	4.2
50	40.3	4.9

**THIS TABLE DOES NOT APPLY TO AGRICULTURAL SPRINKLERS.**

**BRASS IMPULSE SPRINKLER**

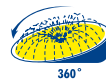

130299

- Cast brass body provides exceptional durability and corrosion resistance.
- Ideal for large-area irrigation in gardens, fields, and agricultural zones.
- Suitable for sandy or abrasive terrain, ensuring reliable long-term performance.
- Adjustable spray pattern for precise water distribution from 0° to 360°.

Capacity and approximate consumption -130299-						
PRESSURE (lb/in <sup>2</sup> )	42.67	49.78	56.89	64	71.11	78.22
PRESSURE (gpm)	16.4	17.7	19	20.1	21.4	22.4
RADIO (ft)	54.4	56.4	57.7	58	58.4	59.4

ITEM	THREAD	⊞	AVAILABLE
130299	1" GHT	1	✓

Capacity and approximate consumption -130298-						
PRESSURE (lb/in <sup>2</sup> )	14.22	21.33	28.44	35.55	42.67	49.78
PRESSURE (gpm)	5.3	6.3	7.9	7.8	8.5	9.1
RADIO (m)	34.8	37.4	42	42	42.6	43.3

ITEM	THREAD	⊞	AVAILABLE
130298	3/4" GHT	1	✓

**PULSATING METAL SPRINKLERS**

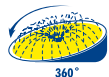

130319

- Steel body provides durability and resistance to corrosion.
- 11" (28 cm) metal stake ensures stable placement on the ground.
- Copper nozzle delivers consistent, long-lasting water performance.
- Single jet spray ideal for focused irrigation in gardens and lawns.

- Adjustable clips and retainers allow precise control of the watering area.
- Adjustable arms let you set different spray patterns as needed.
- Pulsating operation provides even and efficient water distribution.
- Recommended working pressure: 40-50 psi for optimal performance.

ITEM	WAYS	THREAD	⊞	AVAILABLE
130319	2	3/4" GHT	6	✓
130318	1	3/4" GHT	6	✓



130318

- Steel body with 11" (28 cm) metal stake for stable ground placement.
- Copper nozzle delivers a steady, uniform spray pattern.
- Single jet design ideal for garden or lawn irrigation.



130317

- Steel body ensures durability and corrosion resistance.
- Copper nozzle provides consistent water flow and long service life.
- Single jet spray ideal for targeted watering in medium to large areas.



130322

- Zamac body provides strength, corrosion resistance, and long durability.
- Metal nozzles deliver powerful, dual-jet spray coverage.
- Double jet pattern improves water distribution for larger irrigation areas.



130321

- Zamac body provides excellent strength and corrosion resistance.
- 11" (28 cm) metal stake ensures firm and stable ground support.
- Metal nozzles deliver consistent water flow and durability.
- Double jet spray offers wider coverage for efficient lawn and garden irrigation.



130320

- Zamac body provides excellent strength and corrosion resistance.
- Metal nozzles ensure consistent water flow and long service life.
- Double jet spray delivers wider coverage and improved irrigation efficiency.

ITEM	WAYS	THREAD	⊞	AVAILABLE
130321	1	3/4" GHT	6	✓
130320	-	3/4" GHT	6	✓

## IRRIGATION ACCESSORIES

### ADJUSTABLE PLASTIC PULSATING SPRINKLERS WITH METAL STAKE



- Adjustable clips and retainers allow precise control of the watering area.
- Adjustable arms define various spray patterns to suit different irrigation needs.
- Pulsating mechanism ensures uniform water distribution and efficient coverage.
- Recommended working pressure: 40–50 psi for optimal performance.
- Metal stake provides stability and secure placement during operation.

ITEM	WAYS	THREAD	⊕	AVAILABLE
130325	2	3/4" GHT	6	✓



130325

- Plastic body provides lightweight durability and corrosion resistance.
- 11" (28 cm) metal stake ensures stable placement on the ground.
- Single jet spray ideal for focused watering in gardens and lawns.



130324

- Plastic body provides lightweight durability and corrosion resistance.
- 11" (28 cm) metal stake ensures stable placement on the ground.
- Single jet spray ideal for focused watering in gardens and lawns.



130323

- Plastic body provides lightweight durability and corrosion resistance.
- Single jet spray ideal for focused watering in gardens and lawns.



NEW



### UNIVERSAL METAL STAKE FOR SPRINKLERS



- Zamac body provides strength and corrosion resistance.
- Chrome-plated finish enhances durability and prevents oxidation.
- Compatible with all Surtek sprinklers.

ITEM	WAYS	LENGHT PULG	INLET THREAD CM	⊕	AVAILABLE
130332	2	11	28	6	✓



NEW



### PULSATING SPRINKLERS WITH METAL BASE



- Wide, solid base provides excellent stability during operation.
- Brass connectors ensure durability and a secure, leak-free connection.
- Recommended working pressure: 40 psi for optimal performance.
- Ideal for watering gardens, lawns, and landscaped areas with consistent coverage.

ITEM	BASE	INLET THREAD	⊕	AVAILABLE
130316	Metalic	3/4" GHT	1	✓



130316



130315



NEW



### TWO-ARM STATIONARY SPRINKLER WITH METAL BASE

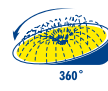

- Brass spray arms provide durability and even water distribution.
- Adjustable jet nozzles allow customized spray patterns for different areas.
- Brass arms, nozzles, and hose connector ensure long-lasting corrosion resistance.
- Recommended working pressure: 40–50 psi for optimal performance.

ITEM	BASE	INLET THREAD	⊕	AVAILABLE
130312	Metalic	3/4" GHT	4	✓



NEW



### THREE-ARM STATIONARY SPRINKLERS WITH METAL BASE

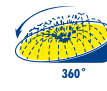

- Brass nozzles and hose connector provide durability and corrosion resistance.
- Metal spray arms ensure even water distribution and long service life.
- Adjustable jet nozzles allow customized watering patterns.
- Recommended working pressure: 40–50 psi for optimal performance.
- Base with wheels allows easy movement and positioning across the watering area.

ITEM	BASE	INLET THREAD	⊕	AVAILABLE
130314	With wheels	3/4" GHT	3	✓



130314



130347



NEW



### OSCILLATING SPRINKLER



#### 4 FUNCTIONS



- Plastic body with aluminum spray tube provides lightweight durability and corrosion resistance.
- 15 spray nozzles deliver wide and even water coverage.
- Multiple watering patterns for customized irrigation.
- Includes nozzle cleaning pin for easy maintenance and clog-free operation.
- Ideal for large watering areas such as lawns, gardens, and landscapes.

ITEM	BASE	LENGHT	INLET THREAD	⊕	AVAILABLE
130330	Plastic	18"	3/4" GHT	1	✓



NEW



### PLASTIC SHOWER-HEAD SPRINKLER WITH ALUMINUM HANDLE



#### 6 FUNCTIONS



- Plastic sprinkler head provides uniform water distribution.
- Aluminum handle offers lightweight strength and corrosion resistance.
- Built-in shut-off valve for convenient water control.
- Recommended working pressure: 40–50 psi for optimal performance.

ITEM	LENGHT INCHES	LENGHT CENTIMETER	INLET THREAD	⊕	AVAILABLE
130329	30	76	3/4" GHT	1	✓



NEW



IRRIGATION ACCESSORIES

METALLIC SPRINKLER

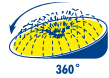

130326

- Coarse jet.



130327

- Fine jet.

- Aluminum body provides durability, corrosion resistance, and lightweight handling.
- Recommended working pressure: 40–50 psi for optimal performance.

ITEM	THREAD	☞	AVAILABLE
130326	3/4" GHT	6	✓
130327	3/4" GHT	6	✓



BRASS NOZZLE



130337

- Solid brass body provides high durability and corrosion resistance.
- Adjustable spray pattern from fine mist to strong jet for versatile use
- Recommended working pressure: 40–50 psi for optimal performance.

ITEM	LENGTH	TYPE	THREAD	☞	AVAILABLE
130336	3"	Straight	3/4" GHT	5	✓
130337	3.5"	Straight	3/4" GHT	5	✓
130338	4"	Straight	3/4" GHT	5	✓



CONNECTOR SETS



130374



130370  
Female



130371  
Male

- Solid brass body provides durability and corrosion resistance.
- 3/4" GHT female thread fits standard garden hose connections.
- Ensures a secure, leak-free fit for reliable water flow.

- Solid brass body provides durability and corrosion resistance.
- 3/4" GHT female thread fits standard garden hose connections.
- Ensures a secure, leak-free fit for reliable water flow.

- Solid brass body provides durability and corrosion resistance.
- 3/4" GHT female thread fits standard garden hose connections.
- Ensures a secure, leak-free fit for reliable water flow.

ITEM	CONNECTOR	HOSE DIAMETER	THREAD	☞	AVAILABLE
130372	Male-female	1/2"	3/4" GHT	1	✓
130373	Male-female	5/8"	3/4" GHT	1	✓
130374	Male-female	3/4"	3/4" GHT	1	✓

ITEM	CONNECTOR	HOSE DIAMETER	THREAD	☞	AVAILABLE
130370	Female	1/2"	3/4" GHT	12	✓
130371	Male	1/2"	3/4" GHT	12	✓

PLASTIC IRRIGATION CONNECTORS



130377



130376

- Plastic body provides lightweight durability and corrosion resistance.
- Easy-connect fittings allow quick installation without tools.
- Designed for standard garden hoses and watering accessories.

ITEM	CONNECTOR	HOSE DIAMETER	THREAD	☞	AVAILABLE
130377	Female	1/2"	3/4" GHT	12	✓
130380	Female	5/8" to 3/4"	3/4" GHT	12	✓
130376	Male	1/2"	3/4" GHT	12	✓
130379	Male	5/8" to 3/4"	3/4" GHT	12	✓



HOSE CONNECTOR SET



2  
PIECES



- Plastic body provides lightweight durability and corrosion resistance.
- Easy-connect fittings allow quick installation without tools.
- Designed for standard garden hoses and watering accessories.

ITEM	CONNECTOR	HOSE DIAMETER	THREAD	☞	AVAILABLE
130335	Male-female	1/2"	3/4" GHT	12	✓



FEMALE QUICK-CONNECT WITH MALE ADAPTER



2  
PIECES



130383



130382

- Plastic body provides lightweight durability and corrosion resistance.
- Easy-connect fittings allow quick installation without tools.
- Designed for standard garden hoses and watering accessories.

ITEM	CONNECTOR	HOSE DIAMETER	THREAD	☞	AVAILABLE
130383	Male-Female	1/2"	3/4" GHT	6	✓
130382	Male-Female	1/2"	3/4" GHT	6	✓



MALE HOSE CONNECTOR



- Plastic body provides lightweight durability and corrosion resistance.
- Easy-connect fittings allow quick installation without tools.
- Designed for standard garden hoses and watering accessories.

ITEM	CONNECTOR	HOSE DIAMETER	THREAD	☞	AVAILABLE
130384	MALE	3/4"	3/4" GHT	24	✓



## IRRIGATION ACCESSORIES

### HOSE REPAIR MENDER



- Plastic body provides durability and corrosion resistance.
- Ideal for repairing all types of garden hoses quickly and easily.

ITEM	CONNECTOR	HOSE DIAMETER	THREAD	⊞	AVAILABLE
130378	Male	1/2"	3/4" GHT	12	✓
130381	Male	5/8" a 3/4"	3/4" GHT	12	✓

### GARDEN HOSE GASKETS



10  
PIECES

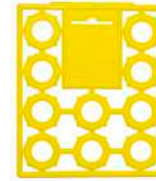

- Made of durable rubber for a tight, leak-free seal.
- Fits standard 3/4" hose connections.
- Easy to install and replace for reliable performance.

ITEM	CONTENT	⊞	AVAILABLE
130375	10 Gaskets	25	✓

### IRRIGATION WATER SPRAY GUNS WITH PVC COATING



130342



130341



130349

- Brass nozzle provides durability and corrosion resistance for long-lasting performance.

- Front trigger design with locking clip allows continuous watering without hand fatigue.
- Brass nozzle provides durability and corrosion resistance for long-lasting performance.

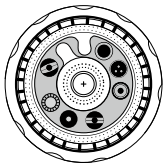

9 functions

	Thick		Mist		Jet
	Horizontal		Cone		Full
	Fan		Soaker		Shower



130348

- Front trigger design with locking clip allows continuous watering without hand fatigue.

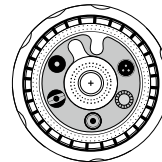

7 functions

	Mist		Full		Jet
	Fan		Cone		Soaker
	Shower				



130340

- Metal body with PVC coating provides a firm, comfortable grip and corrosion resistance.
- Recommended working pressure: 40–50 psi for optimal performance.

ITEM	THREAD	FUNCTION	⊞	AVAILABLE
130342	3/4" GHT	Irrigation metallic	1	✓
130341	3/4" GHT	Adjustable metal nozzle	1	✓
130349	3/4" GHT	Adjustable automatic metal nozzle	1	✓

ITEM	THREAD	FUNCTION	⊞	AVAILABLE
130348	3/4" GHT	9	1	✓
130340	3/4" GHT	7	1	✓

### STEEL IRRIGATION WATER SPRAY GUNS

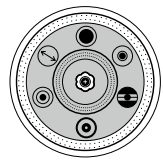

6 functions

	Full		Lance type
	Horizontal		Fine
	Cone		Shower



130344



130345



130346

- Locking clip for continuous watering.
- Recommended working pressure: 40–50 psi for optimal performance.

- Brass nozzle provides durability and corrosion resistance for long-lasting performance.

ITEM	THREAD	FUNCTION	⊞	AVAILABLE
130344	3/4" GHT	6	6	✓
130345	3/4" GHT	Adjustable nose	6	✓
130346	3/4" GHT	Irrigation	6	✓

IRRIGATION ACCESSORIES

HOSE REEL TROLLEY



130363

- Tray for sprinklers, gloves, and other gardening accessories.
- Keeps essential tools organized and within easy reach during use.



PMR45

- Folding handle.

- Compatible with 1/2" and 5/8" hoses.
- Facilitates easy rewinding and organized storage of garden hoses.
- Lightweight and portable design for convenient transport and use.
- Ideal for maintaining tidy and efficient watering areas.

ITEM	130363	PMR45
THREAD	3/4" GHT	1/2" GHT
REEL WIDTH	15-3/4"/40 cm	6-7/8"/17.5 cm
WIDTH	13"	17-11/16"
DEPTH	6-5/32"	14"
HEIGHT	25"	32"
HOSE CAPACITY		
1/2"	236 ft	62 ft
5/8"	197 ft	46 ft
☒	1	1
AVAILABLE	✓	On Request

HOSE REEL TROLLEY



130362



PME25



PMS20

- Compatible with 1/2" and 5/8" hoses.
- Compact and durable design ensures long-lasting performance.
- Facilitates easy rewinding and organized storage of garden hoses.
- Can be mounted on any flat surface for added convenience and stability.
- Ideal for keeping garden areas tidy and hoses protected from damage.

ITEM	130362	PME25	PMS20
THREAD	3/4" GHT	N/A	N/A
REEL WIDTH	15"/38.1 cm	6"/15 cm	4"/10.2 cm
WIDTH	19-19/32"	6-5/32"	6-5/32"
DEPTH	4-5/16"	8-5/32"	10-5/32"
HEIGHT	19-5/32"	7"	6-5/32"
HOSE CAPACITY			
1/2"	246 ft	93 ft	65 ft
5/8"	147 ft	33 ft	33 ft
☒	1	1	1
AVAILABLE	✓	On Request	On Request

HOSE REEL TROLLEY



130360



PMM45

- Compatible with 1/2" and 5/8" hoses.
- Facilitates easy rewinding and organized storage of garden hoses.
- Lightweight and portable design for convenient transport and use.
- Ideal for maintaining tidy and efficient watering areas.

ITEM	130360	PMM45
THREAD	3/4" GHT	1/2" GHT
REEL WIDTH	15-3/4"/40 cm	6-7/8"/17.5 cm
WIDTH	5-1/2"	5-1/2"
DEPTH	13-11/16"	14-3/32"
HEIGHT	15"	17-11/16"
HOSE CAPACITY		
1/2"	197 ft	147 ft
5/8"	147 ft	98 ft
☒	1	1
AVAILABLE	✓	On Request

## GARDEN HOSE



•No-torsion reinforce rib to avoid deformation and twisting.



•Six-layer garden hose: 2 layers with 2 reinforced ribs, 2 PVC high-strength black layers, 1 nylon layer, 1 external color layer and 1 external reinforced plastic rib.

### ROLL 6-LAYER REINFORCED GARDEN HOSE



URREA



NEW



- Anti-kink rib design prevents twisting and deformation during use.
- Six-layer reinforced construction provides strength, flexibility, and long service life.
- Resistant to pressure, UV rays, and temperature changes.
- Ideal for heavy-duty garden and landscaping applications.

ROLL

ITEM	DIAMETER	LENGTH	MAX. WORKING PRESSURE	WALL THICKNESS	⊞	AVAILABLE
MU58R100	5/8"	32.8 ft	350 psi	3/32"	1	✓

### 6-LAYER REINFORCED GARDEN HOSE WITH BRASS CONNECTORS



URREA



NEW



- Anti-kink rib design prevents twisting and deformation during use.
- Six-layer reinforced construction provides strength, flexibility, and long service life.
- Resistant to pressure, UV rays, and temperature changes.
- Ideal for heavy-duty garden and landscaping applications.

ROLL

ITEM	DIAMETER	LENGTH	MAX. WORKING PRESSURE	WALL THICKNESS	⊞	AVAILABLE
MU58R25	5/8"	82 ft	350 psi	3/32"	1	✓

AGRICULTURE AND GARDENING



•Reinforced rib with anti-kink technology prevents twisting and deformation.



•Four-layer construction: triple-layer high-strength PVC with a woven polyester mesh reinforcement.

### ROLL CONTRACTOR GARDEN HOSES



SURTEK



NEW

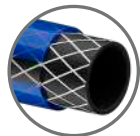

- Designed for high pressure and intensive professional use.
- Ideal for construction sites, industrial maintenance, and heavy-duty garden work.

ROLL

ITEM	DIAMETER	LENGTH	MAX. WORKING PRESSURE	WALL THICKNESS	⊞	AVAILABLE
M12C50	1/2"	164 ft	250 psi	3/32"	1	✓
M12C100	1/2"	328 ft	250 psi	3/32"	1	On Request



GARDEN HOSES

CONTRACTOR GARDEN HOSES WITH METAL CONNECTORS



- New plastic end cap for easier tightening and secure connection.
- Upgraded metal connectors—stronger and more durable for extended service life.
- Reinforced rib with anti-kink technology prevents twisting and maintains optimal water flow.
- Ideal for professional, industrial, and heavy-duty garden applications

ROLL

ITEM	DIAMETER	LENGTH	MAX. WORKING PRESSURE	WALL THICKNESS	⊞	AVAILABLE
M12C10	1/2"	32 ft	250 psi	3/32"	1	✓
M12C15	1/2"	49 ft	250 psi	3/32"	1	✓
M12C20	1/2"	65 ft	250 psi	3/32"	1	✓
M12C25	1/2"	82 ft	250 psi	3/32"	1	✓



M12C10

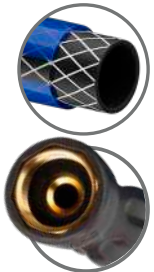

CONTRACTOR GARDEN HOSE WITH PLASTIC CONNECTORS



- High-durability plastic connectors ensure a secure, long-lasting fit.
- Reinforced rib with anti-kink technology prevents twisting and maintains constant water flow.
- Flexible and lightweight design for easy handling and storage.
- Ideal for residential, commercial, and general garden use.

ROLL

ITEM	DIAMETER	LENGTH	MAX. WORKING PRESSURE	WALL THICKNESS	⊞	AVAILABLE
M12C6	1/2"	19.6 ft	250 psi	3/32"	1	✓

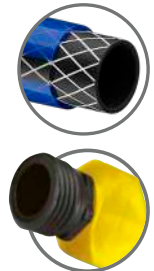

• Triple anti-kink ribs along the hose prevent deformation and ensure a continuous water flow.



• Three-layer construction: dual-layer high-strength PVC with a spider-web woven polyester mesh for enhanced reinforcement.

ROLL SPIDER WOVEN GARDEN HOSES



- Flexible, durable design resists twisting, pressure, and temperature changes.
- Ideal for heavy-duty garden, agricultural, and landscaping applications.

ROLL

ITEM	DIAMETER	LENGTH	MAX. WORKING PRESSURE	WALL THICKNESS	⊞	AVAILABLE
M12S50	1/2"	164 ft	200 psi	3/32"	1	✓
M12S100	1/2"	328 ft	200 psi	3/32"	1	✓
M58S100	5/8"	328 ft	150 psi	3/32"	1	✓
M34S100	3/4"	328 ft	130 psi	3/32"	1	✓
M1S50	1"	164 ft	105 psi	3/32"	1	✓
M1S100	1"	328 ft	105 psi	3/32"	1	✓



M12S100

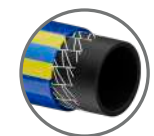

## GARDEN HOSES

### SPIDER WOVEN GARDEN HOSES WITH METAL CONNECTORS



**SURTEK**  
TOOLS FOR SPECIALISTS



- New plastic end cap allows easier tightening and secure fitting.
- Upgraded metal connectors provide greater strength, durability, and leak resistance.
- Reinforced rib with anti-kink technology prevents twisting and ensures constant water flow.
- Ideal for professional gardening, landscaping, and heavy-duty outdoor use.

ROLL

ITEM	DIAMETER	LENGTH	MAX. WORKING PRESSURE	WALL THICKNESS	☐	AVAILABLE
M12S10	1/2"	32 ft	200 psi	5/64"	1	✓
M12S15	1/2"	49 ft	200 psi	5/64"	1	✓
M12S20	1/2"	65 ft	200 psi	5/64"	1	✓
M12S25	1/2"	82 ft	200 psi	5/64"	1	✓
M34S25	3/4"	82 ft	130 psi	3/32"	1	✓



M12S10

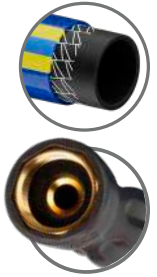

### SPIDER WOVEN GARDEN HOSES WITH PLASTIC CONNECTORS



**SURTEK**  
TOOLS FOR SPECIALISTS



NEW

- High-durability plastic connectors ensure a secure and long-lasting fit.
- Flexible, lightweight, and easy to handle for everyday garden use.
- Ideal for residential gardening, lawn care, and light landscaping.

ROLL

ITEM	DIAMETER	LENGTH	MAX. WORKING PRESSURE	WALL THICKNESS	☐	AVAILABLE
M12S6	1/2"	19 ft	200 psi	5/64"	1	✓
M12S10P	1/2"	32 ft	200 psi	5/64"	1	On Request
M12S15P	1/2"	49 ft	200 psi	5/64"	1	On Request
M12S20P	1/2"	65 ft	200 psi	5/64"	1	On Request
M12S25P	1/2"	82 ft	200 psi	5/64"	1	On Request



M12S6

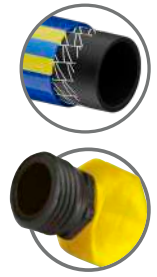

AGRICULTURE AND GARDENING

### SPIDER WOVEN GARDEN HOSE WITH SPRAY GUN



**SURTEK**  
TOOLS FOR SPECIALISTS



NEW

- Includes 7-function spray gun, model 130340, for versatile watering options.
- Reinforced rib with anti-kink technology prevents twisting and ensures constant water flow.
- Durable and flexible construction for easy handling and storage.
- Ideal for garden, lawn, and outdoor maintenance tasks.

ROLL

ITEM	DIAMETER	LENGTH	MAX. WORKING PRESSURE	WALL THICKNESS	☐	AVAILABLE
JM12S15	1/2"	49 ft	200 psi	5/64"	1	✓



**GARDEN HOSES**



• Surtek Poly-Web weaving increases the polyester density per square centimeter, enhancing hose strength and extending service life.



• Surtek Poly-Web weaving increases the polyester density per square centimeter, enhancing hose strength and extending service life.

**ROLL WOVEN GARDEN HOSES**



**NEW**



**M12T100**

**ROLL**

ITEM	DIAMETER	LENGTH	MAX. WORKING PRESSURE	WALL THICKNESS	☐	AVAILABLE
<b>M12TV50</b>	1/2"	164 ft	200 psi	1/16"	1	✓
<b>M12T100</b>	1/2"	328 ft	200 psi	1/16"	1	✓
<b>M58T100</b>	5/8"	328 ft	150 psi	3/32"	1	✓
<b>M34T100</b>	3/4"	328 ft	130 psi	3/32"	1	✓
<b>M1T50</b>	1"	164 ft	105 psi	1/8"	1	✓
<b>M1T100</b>	1"	328 ft	105 psi	1/8"	1	✓

**WOVEN GARDEN HOSES WITH METAL CONNECTORS**



**M12T10**

**ROLL**

ITEM	DIAMETER	LENGTH	MAX. WORKING PRESSURE	WALL THICKNESS	☐	AVAILABLE
<b>M12T10</b>	1/2"	32 ft	200 psi	1/16"	1	✓
<b>M12T15</b>	1/2"	49 ft	200 psi	1/16"	1	✓
<b>M12T20</b>	1/2"	65 ft	200 psi	1/16"	1	✓
<b>M12T25</b>	1/2"	82 ft	200 psi	1/16"	1	✓
<b>M58T15</b>	5/8"	49 ft	150 psi	3/32"	1	✓
<b>M58T20</b>	5/8"	65 ft	150 psi	3/32"	1	✓
<b>M58T25</b>	5/8"	82 ft	150 psi	3/32"	1	On Request
<b>M34T25</b>	3/4"	82 ft	130 psi	3/32"	1	✓

**WOVEN GARDEN HOSES WITH PLASTIC CONNECTORS**



**NEW**



- High-durability plastic connectors ensure a secure and long-lasting fit
- Ideal for continuous garden use, landscaping, and general irrigation applications.

**ROLL**

ITEM	DIAMETER	LENGTH	MAX. WORKING PRESSURE	WALL THICKNESS	☐	AVAILABLE
<b>M12T6</b>	1/2"	19 ft	200 psi	1/16"	1	✓

## GARDEN HOSES

### WOVEN GARDEN HOSE WITH SPRAY GUN



**SURTEK**  
TOOLS FOR SPECIALISTS



**NEW**



- Includes multi-function spray gun for versatile watering applications.
- Ideal for garden, lawn, and home irrigation tasks.

**ROLL**

ITEM	DIAMETER	LENGTH	MAX. WORKING PRESSURE	WALL THICKNESS	☐	AVAILABLE
JM12ST15	1/2"	49 ft	200 psi	1/16"	1	✓

### GRAY WOVEN GARDEN HOSES WITH PLASTIC CONNECTORS



**SURTEK**  
TOOLS FOR SPECIALISTS



**NEW**

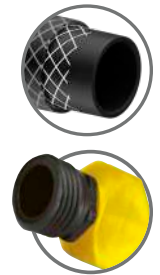

- High-durability plastic connectors ensure a secure and leak-free connection.
- Ideal for residential gardening, lawn care, and general irrigation use.

**ROLL**

ITEM	DIAMETER	LENGTH	MAX. WORKING PRESSURE	WALL THICKNESS	☐	AVAILABLE
M12T10P	1/2"	32 ft	200 psi	1/16"	1	✓
M12T15P	1/2"	49 ft	200 psi	1/16"	1	✓
M12T20P	1/2"	65 ft	200 psi	1/16"	1	✓

M12T10P

### FLAT GARDEN HOSE WITH SPRAY GUN



**SURTEK**  
TOOLS FOR SPECIALISTS



**VIDEO**

Content	
Hose holder hook	1
Spray gun 8 functions	1
Bag for storage	1

- Includes multi-function spray gun for versatile watering options.
- Flat design allows compact storage and easy transport when not in use.
- Durable, flexible material resists twisting and ensures a consistent water flow.
- Ideal for home gardens, yards, and general outdoor irrigation.

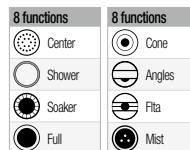

ITEM	LENGTH WITH MINIMUM PRESSURE	LENGTH AT MAXIMUM PRESSURE	MAXIMUM PRESSURE OF WORKING	WALL THICKNESS	☐	AVAILABLE
MPP15	16 ft	50 ft	110 psi	1.5 mm	1	On Request



CLASS	TYPE	PAGE	BRAND		
			URREA	SURTEK	
Rough construction	Hoes	588		•	
	Rebar tie wire twister	588		•	
	Wheelbarrows	588		•	
	Level hoses	589		•	
	Brik trowels	589		•	
	Rebar wrenchs	589		•	
	Threads	589		•	
	Shovels	590		•	
	Brass barrel-type plumbs	593		•	
	Brass plumbs	593		•	
	Picks	593		•	
	Tampers	593		•	
	Construction finishes	Tile tool sets	594	•	•
		Suction cups	594		•
Tile cutters		594	•	•	
Putty knives and wedges		596	•	•	
Floats		597		•	
Notched hand trowels		598		•	
Steel fish tapes		598	•	•	
Caulking gun		599	•	•	
Paint	Groover and dumper	599		•	
	Paint brushes, rollers, and applicator brushes	600		•	
	Bucket opener	602		•	
	Masking tape	602	•	•	

We are constantly improving our products, that is why the information, characteristics and availability of them can change without prior notice.

usa.urrea.com

## METAL ROD TYLERS

### CONICAL TIP WIRE TWISTER



115158



NEW

BULK

- Enhanced wear resistance and protection against oxidation.
- Conical tip allows easy access to hard-to-reach areas.
- Angled design provides a stronger and more secure grip on the rebar.

ITEM	LENGTH	☐	AVAILABLE
115157	10 -1/2"	1	✓
115158	12"	1	✓

## HOES

### MORTAR HOES WITH HANDLE

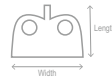

130038



- 60" woodhandle.
- Forged in one piece in high carbon steel.
- Crimped handle.

ITEM	BLADE WIDTH	BLADE HEIGHT	☐	AVAILABLE
130038	7"	4-3/8"	4	✓
130039	10"	6"	4	✓

BULK

## WHEELBARROWS

### 6 FT<sup>3</sup> REINFORCED WHEELBARROWS WITH METAL HANDLE



CAT602



CAT804



VIDEO

NEW

BULK

- Exceeds Federal KKK-W-291F standard.
- Heavy-duty steel frame for greater durability and load resistance.
- Reinforced 6 cu ft tray ideal for construction and landscaping materials.
- Corrosion-resistant finish extends the tool's service life.
- Ergonomic metal handles provide better control and maneuverability.

ITEM	CAT602	CAT604	CAT60S	CAT60X	CAT804	CAT80X
TIRE TYPE	Pneumatic	Heavy-duty pneumatic	Solid	Polyurethane	Flat free	Heavy duty
TRAY THICKNESS (GAUGE)	20	20	20	20	20	20
CAPACITY (FT <sup>3</sup> )	6	6	6	6	8	8
CAPACITY (LT)	105	105	105	105	227	227
COLOR						
☐	3	3	3	3	1	1
AVAILABLE	On Request	On Request	✓	On Request	✓	✓

## TRAYS

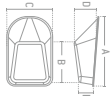

- Heavy-duty steel frame for greater durability and load resistance.
- Reinforced 6 cu ft tray ideal for construction and landscaping materials.

BULK

ITEM	CAPACITY	MATERIAL	MEASURE A	MEASURE B	MEASURE C	MEASURE D	MEASURE E	COLOR	GAUGE	☐	AVAILABLE
For american-style design (4 holes)											
CS60	6 ft <sup>3</sup>	Steel	37"	16-1/2"	28"	14-1/2"	7"		20	1	✓

## TIRE



CTLR Heavy duty 16"



- Greater strength and improved performance for heavy-duty use.
- Enhanced flexibility for a smoother ride and longer service life.

BULK

ITEM	TIRE TYPE	☐	AVAILABLE
CTLR	Heavy duty	1	On Request

## HANDLES



CATB



CTBASTM

BULK

ITEM	DESCRIPTION	☐	AVAILABLE
CATB	Metallic tubular	3	On Request

BULK

ITEM	DESCRIPTION	☐	AVAILABLE
CTBASTM	Wood	1	✓

**BRICK TROWELS**

**BRICK TROWELS**



**CFP9**  
• Forged in one piece.



**CUP9**  
• Welded spoon



**CFG9**  
• Forged in one piece.



**CUG9**  
welded spoon

- High-carbon steel blade offers superior wear resistance and durability.
- Profiled blade design provides greater control and precision when spreading mortar.
- Ideal for bricklaying, finishing, and detailed masonry work.

ITEM	SIZE	TYPE	MANUFACTURING	BLADE WIDTH	☞	AVAILABLE
CFP6	6"	Philadelphia	Forged	3-3/16"	3	On Request
CFP9	9"	Philadelphia	Forged	4-17/32"	3	On Request
CFP10	10"	Philadelphia	Forged	5-1/16"	3	On Request
CFP11	11"	Philadelphia	Forged	5-1/2"	3	On Request
CUP6	6"	Philadelphia	Welded	3-17/32"	3	On Request
CUP7	7"	Philadelphia	Welded	3-4/5"	3	On Request

ITEM	SIZE	TYPE	MANUFACTURING	BLADE WIDTH	☞	AVAILABLE
CUP8	8"	Philadelphia	Welded	4-1/4"	3	On Request
CUP9	9"	Philadelphia	Welded	4-15/16"	3	On Request
CUP10	10"	Philadelphia	Welded	5-1/8"	3	On Request
CUP11	11"	Philadelphia	Welded	5-1/8"	3	On Request
CFG9	9"	Guadalajara	Forged	5-3/4"	3	On Request
CUG9	9"	Guadalajara	Welded	5-3/4"	3	On Request

**BULK**

**REBAR WRENCHS**

**DOUBLE JAW REBAR WRENCH**



5/8" open for 1/2" rod      74 cm (29-1/8")      1/2" open for 3/8" rod

**NEW**



- Designed for gripping, twisting, or straightening rebar quickly and efficiently.
- Forged jaws provide superior strength and resistance to deformation or breakage.
- Ideal for heavy-duty construction and reinforcement work.

ITEM	OPEN SIZE	FOR ROD SIZE	LENGTH	☞	AVAILABLE
130080	5/8" 1/2"	1/2" 3/8"	29-1/8"	3	✓

**THREADS**

**CONSTRUCTION THREADS**



130567

**NEW**

- Made of 100% multifilament polypropylene for superior strength and flexibility.
- Gauge No. 18.
- Tensile strength: 30.8 lb (≈14 kg).
- Manufactured with a 5,040-denier, 3-ply construction for maximum durability and knot retention.
- Ideal for masonry layout, leveling, and alignment work on construction sites.

ITEM	LENGTH	☞	AVAILABLE
130567	213 Ft	12	✓
130568	541 Ft	12	✓

**LEVEL HOSES**

**LEVEL HOSES**



122275

- Made of transparent PVC for easy fluid visibility and accurate readings.
- Working temperature range: 50°F to 140°F (10°C to 60°C).
- Ideal for leveling and alignment tasks in construction projects.
- Flexible and durable design ensures long-lasting performance on the job site.

ITEM	DIAMETER	LENGTH	☞	AVAILABLE
122275	1/4"	328 Ft	1	On Request
122276	5/16"	328 Ft	1	On Request
122277	3/8"	328 Ft	1	On Request



CONSTRUCTION TOOLS

## SHOVELS

### INDUSTRIAL-SERIES LONG FIBERGLASS HANDLE SHOVELS



- Fiberglass handle with non-slip grip for greater comfort and control.



- Crimped metal ring reinforcement at the joint for added strength and durability.

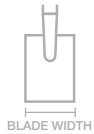

- 40" handle length.
- Designed for heavy-duty industrial and construction applications.



**BULK**

ITEM	130626	130627	130628	130625
BLADE TYPE	Round	Square	Irrigation	Scoop
BLADE WIDTH	8-1/2"	9-1/2"	9"	11-3/4"
⊞	3	3	3	3
AVAILABLE	✓	✓	✓	✓

### INDUSTRIAL-SERIES LONG WOOD HANDLE SHOVELS



- Long handle design reduces effort and increases working efficiency.



- Crimped metal ring reinforcement at the joint for added strength and durability.

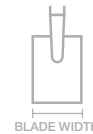

- 40" handle length.
- Designed for heavy-duty industrial and construction applications.



**NEW**



**BULK**

ITEM	PALRCL	PALCCL	PALICL	PALACL
BLADE TYPE	Round	Square	Irrigation	Scoop
BLADE WIDTH	8-1/2"	9-1/2"	9"	11-3/4"
⊞	3	3	3	3
AVAILABLE	✓	✓	✓	✓

### PROFESSIONAL-SERIES LONG FIBERGLASS HANDLE SHOVELS



- Fiberglass handle with non-slip grip for greater comfort and control.



- Crimped metal ring reinforcement at the joint for added strength and durability.

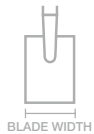

- 42" handle length.
- Designed for heavy-duty industrial and construction applications.



**BULK**

ITEM	130605	130606	130607
BLADE TYPE	Round	Square	Irrigation
BLADE WIDTH	8-1/2"	9-1/2"	9"
⊞	3	3	3
AVAILABLE	✓	✓	✓

### PROFESSIONAL-SERIES LONG WOOD HANDLE SHOVELS



- Long handle design reduces effort and increases working efficiency.

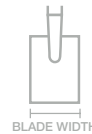

- 38" handle length.
- Designed for heavy-duty industrial and construction applications.



**NEW**



**BULK**

ITEM	PALRL	PALCL	PALIL
BLADE TYPE	Round	Square	Irrigation
BLADE WIDTH	8-1/2"	9-1/2"	9"
⊞	3	3	3
AVAILABLE	✓	✓	✓

### Y-HANDLE SHOVELS WITH METAL HANDLE



- Metal Y-grip handle with crimped ring securely attached to the shaft.



- Double crimped metal ring reinforcement adds strength and durability, extending the shovel's service life.

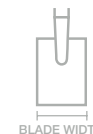

- Handle length: 34-3/8".
- Ideal for heavy-duty digging and material handling in construction and landscaping.



**BULK**

ITEM	PALRM1	PALCM1	PALEM1
BLADE TYPE	Round	Square	Garden spade
BLADE WIDTH	8-1/2"	9-1/2"	7-1/4"
⊞	3	3	3
AVAILABLE	✓	✓	✓



SHOVELS

INDUSTRIAL-SERIES D-HANDLE SHOVELS WITH FIBERGLASS HANDLE



Reinforced straight plastic D-grip for better control and comfort.



Crimped metal ring reinforcement at the joint for extra rigidity and long service life.



130680 130681 130682 130684

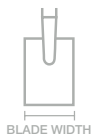

30" fiberglass handle provides strength, durability, and shock absorption.  
Built for demanding industrial, construction, and landscaping applications.

BULK

ITEM	130680	130681	130682	130684
BLADE TYPE	Round	Square	Garden spade	Scoop
BLADE WIDTH	8-7/8"	9-3/8"	7-3/8"	11-3/4"
☒	3	3	3	3
AVAILABLE	✓	✓	✓	✓

PROFESSIONAL-SERIES CONTRACTOR D-HANDLE SHOVELS WITH WOOD HANDLE



130600 130601 130604

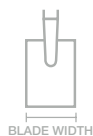

30" handle length.  
High carbon steel blade.

BULK

ITEM	130600	130601	130604
BLADE TYPE	Round	Square	Scoop
BLADE WIDTH	8-1/2"	9-1/2"	11-3/4"
☒	3	3	3
AVAILABLE	✓	✓	✓

INDUSTRIAL-SERIES Y-HANDLE SHOVELS WITH WOOD HANDLE



Metal Y-grip riveted to the wooden handle for a secure and durable connection.



Crimped metal ring reinforcement at the joint for added strength.



130620 130621 130622 130623 130624

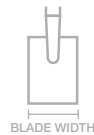

Double crimped ring increases resistance and durability, extending the shovel's service life.  
30" handle length.  
Ideal for construction, landscaping, and general-purpose digging tasks.

BULK

ITEM	130620	130621	130622	130623	130624
BLADE TYPE	Round	Square	Garden spade	Drain spade	Scoop
BLADE WIDTH	8-1/2"	9-1/2"	7-1/4"	5-1/4"	11-3/4"
☒	3	3	3	3	3
AVAILABLE	✓	✓	✓	✓	✓

ONE-PIECE INJECTION-MOLDED SHOVELS WITH HIGH-STRENGTH PLASTIC HANDLE AND GRIP



NEW



Reinforced PVC straight handle.



PALRP PALCP PALAP PALEP

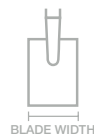

15° angled handle design allows easier, more comfortable, and ergonomic shoveling.  
Patented one-piece handle and grip deliver superior strength, prevent deformation, and reduce overall weight.  
30" handle length for optimal leverage and control.

BULK

ITEM	PALRP	PALCP	PALAP	PALEP
TIPO	Round	Square	Scoop	Garden Spade
BLADE WIDTH	8-1/2"	9-1/2"	11-3/4"	7-1/4"
☒	3	3	3	3
AVAILABLE	On Request	On Request	On Request	On Request

## SHOVELS

### PROFESSIONAL-SERIES Y-HANDLE SHOVELS WITH WOOD HANDLE



Reinforced straight plastic D-grip for better control and comfort.



130602

130603

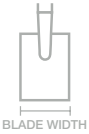

30" handle length for optimal leverage and control.

**BULK**

ITEM	130602	130603
BLADE TYPE	Garden spade	Drain spade
BLADE WIDTH	7-1/4"	5-1/4"
	3	3
AVAILABLE	✓	✓

### ONE-PIECE INJECTION-MOLDED SCOOP SHOVELS WITH HIGH-STRENGTH PLASTIC HANDLE AND GRIP



**NEW**



PALCRP

PALCCP



Patented one-piece handle and grip design provides superior strength, prevents deformation, and reduces weight. 19-1/2" handle length for compact, easy handling and excellent control.

**BULK**

ITEM	PALCRP	PALCCP
BLADE TYPE	Round	Square
BLADE WIDTH	8-1/2"	8-1/2"
	3	3
AVAILABLE	✓	✓

### CONTRACTOR D-HANDLE ABS SCOOP



130688

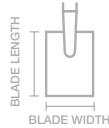

- Lighter than metal shovels, with smooth surfaces for easy cleaning.
- Rust-free construction makes it ideal for sanitary or food-handling tasks.
- 30" handle length for comfortable use and better control.
- Perfect for moving light materials such as grains, snow, or debris.

**BULK**

ITEM	130688
BLADE WIDTH	14-1/4"
BLADE LENGTH	18-5/8"
HANDLE LENGTH	30"
	3
AVAILABLE	✓

### SCOOP SHOVELS WITH WOOD HANDLE AND METAL GRIP



Metallic ring brings more strength.



130631

130630

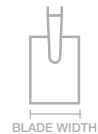

- Reinforced straight plastic D-grip for comfort and control.
- 20" wooden handle provides strength and natural shock absorption.

**BULK**

ITEM	130630	130631
BLADE TYPE	Round	Square
BLADE WIDTH	8-1/2"	8-1/2"
	3	3
AVAILABLE	On Request	✓

### CONTRACTOR D-HANDLE ALUMINIUM SCOOP



130689

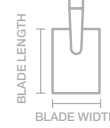

- Lightweight design with smooth surfaces for easy cleaning and handling.
- Rust-free aluminum construction—ideal for sanitary, food-handling, or cleanup tasks.
- 30" handle length provides comfortable leverage and control.
- Perfect for moving light materials such as grain, snow, sand, or debris.

**BULK**

ITEM	130689
BLADE WIDTH	14-3/8"
BLADE LENGTH	15-3/8"
HANDLE LENGTH	33"
	3
AVAILABLE	✓

### REPLACEMENT WOOD HANDLE



- Kiln-dried and polished wood prevents splinters and provides a smoother, more secure grip.
- Lacquered finish enhances durability and protects against moisture and wear.

**BULK**

ITEM	FOR		AVAILABLE
CAB29	For models: industrial & professional series	6	✓

TAMPERS

TAMPERS



130008

130010



- Reinforced head design with structural ribs for added strength and impact resistance.
- Made of ductile cast iron for superior durability and long service life.
- Ideal for leveling and compacting soil, gravel, or asphalt in construction and landscaping work.

**BULK**

ITEM	HEAD DIMENSIONS	HANDLE	☞	AVAILABLE
130008	8" x 8"	48"	2	✓
130010	10" x 10"	48"	2	✓

PLUMBS

BRASS BARREL-TYPE PLUMBS



NEW



123275

- Rectified centers for better precision.

ITEM	NO.	DIAMETER	WEIGHT	☞	AVAILABLE
123274	1	1-3/8"	12 oz	6	On Request
123275	3	1-11/16"	11 oz	6	On Request
123276	4	1-13/16"	20 oz	6	On Request

BRASS PLUMB BOB



123270

- Removable top allows quick and easy string alignment.
- Hardened and precision-ground steel tip ensures long-lasting accuracy.
- Includes a spare replacement tip for extended tool life.
- Ideal for precise vertical alignment in construction and surveying tasks

ITEM	WEIGHT	☞	AVAILABLE
123270	8 oz	6	On Request
123271	12 oz	6	On Request
123272	16 oz	6	On Request
123273	24 oz	4	On Request

PICKS

PICKS WITH FIBERGLASS HANDLE



ZP5MF

TP5MF

- Forged steel head for maximum strength and impact resistance.
- Shock-absorbing collar reduces vibration and protects the handle.
- Lightweight fiberglass handle resists weathering, moisture, and cracking.
- Ideal for breaking hard soil, rocks, or concrete in demanding jobsite conditions.

**BULK**

ITEM	TYPE	WEIGHT	HANDLE LENGTH	☞	AVAILABLE
ZP5MF	Railroad pick	5 lb - 2,2 kg	36"	4	✓
ZP7MF	Railroad pick	7 lb - 3,2 kg	36"	4	✓
TP5MF	Pick - Mattock	5 lb - 2,2 kg	36"	4	On Request

PICKS WITH WOOD HANDLE



ZP5M

PP5M

TP5M

TH5M

- Forged steel head for maximum strength and impact resistance.
- Ideal for breaking hard soil, rocks, or concrete in demanding jobsite conditions.

**BULK**

ITEM	TYPE	WEIGHT	HANDLE LENGTH	☞	AVAILABLE
ZP5M	Railroad pick	5 lb - 2,2 kg	36"	4	✓
ZP7M	Railroad pick	7 lb - 3,2 kg	36"	4	✓
PP5M	Double pick	5 lb - 2,2 kg	36"	4	✓
TP5M	Pick - Mattock	5 lb - 2,2 kg	36"	4	✓
TH5M	Cutter - Mattock	5 lb - 2,2 kg	36"	4	✓

PICK-MATTOCK WITHOUT HANDLE



- Forged steel head for maximum strength and impact resistance.

**BULK**

ITEM	TYPE	WEIGHT	☞	AVAILABLE
TP5	Pick mattock	5 lb - 2,2 kg	6	✓

WOOD HANDLE WITH SHOCK-ABSORBING PLASTIC GUARD



- Shock-absorbing collar reduces vibration and protects the handle from impact damage.
- Ideal for replacement on picks, mattocks, or similar striking tools.
- Provides comfort, durability, and extended tool life during heavy-duty use.

**BULK**

ITEM	TOTAL LENGTH	☞	AVAILABLE
CAB6	36"	6	✓

## SUCTION CUPS

### DOUBLE SUCTION CUP FOR GLASS



NEW



- Ideal for lifting and carrying heavy materials such as glass, mirrors, metal sheets, and automotive glass.
- Ergonomic handle with non-slip grip ensures secure and comfortable handling.
- Dual suction design provides strong holding power and stability during transport or installation.



ITEM	CUP DIAMETER	LOAD CAPACITY	☞	AVAILABLE
107373	4-1/2"	176 lb	1	On Request

## TILE CUTTERS

### TILE INSTALLER SET



6  
PIECES



NEW



Contenido	
TC76	Tile Cutter 1
1367	16 oz Rubber Mallet 1
UN118A	18" Aluminum Level 1
653X	3" Flexible Putty Knife 1
USGNG	PU-Coated Nylon Gloves (Size L) 1
1583LHG	10 ft x 3/4" 1

ITEM	PIECES	☞	AVAILABLE
JAZ6	6	1	On Request

### TILE INSTALLER SET



7  
PIECES



ITEM	Descripción	
CAZ20	20" Reinforced Tile Cutter	1
123160	8" Tile Nipper	1
123205	7/32" Tile Spacer	2
137409	Cotton Gloves with PVC Dots (Size M)	1
123104	4" Flexible Putty Knife with Wooden Handle	1
608	8 oz Rubber Mallet	1



ITEM	PIECES	☞	AVAILABLE
JAZ7S	7	1	On Request

### TILE CUTTERS FOR LARGE FORMATS



1/2" MAX. CUTTING THICKNESS

STRAIGHT CUTS

DIAGONAL CUTS

BLADE MATERIAL TUNGSTEN CARBIDE

COVERED WITH BLACK TITANIUM



REPTC1



- Steel base and aluminum handle for strength and durability.
- Lightweight design for easy handling—more compact than conventional cutters.
- Aluminum side extensions provide support for larger tiles and greater working comfort.
- Cutting force up to 1,100 lb (≈500 kg) for precise, clean cuts on ceramic and porcelain tiles.

ITEM	CUT LENGTH		THICKNESS CUT	DIAGONAL CUT	BASE WIDTH	TOTAL LENGTH	CUTTING WHEEL DIAMETER	☞	AVAILABLE
	INCH	CM							
TC76	30-15/16"	76	1/2"	20-15/16"	3-1/2"	38"	7/8"	1	On Request
TC91	36"	91.4	1/2"	25"	3-1/2"	44-7/8"	7/8"	1	On Request

### Replacement

ITEM	MATERIAL	FOR USE WITH	☞	AVAILABLE
REPTC1	Tungsten carbide	TC61, TC76, TC91	3	✓

TILE CUTTERS

PROFESSIONAL TILE CUTTER

PROFESSIONAL USE **3/8" MAX. CUTTING THICKNESS** DIAGONAL CUT **WC TUNGSTEN CARBIDE BLADE**



• Ball-bearing slides reduce friction for smoother, more precise cutting.

35"



CAZ35

SURTEK TOOLS FOR PROFESSIONALS



RCAZP



- Reinforced metal base provides superior stability and durability.
- Independent lever-breaking system ensures clean tile separation with minimal effort.
- Extendable base supports larger tiles for more comfortable and efficient operation.

ITEM	CUTTING LENGTH		THICKNESS CUT	DIAGONAL CUT	BASE WIDTH	TOTAL LENGTH	CUTTING WHEEL DIAMETER	☞	AVAILABLE
	IN	CM							
CAZ24	24"	63	3/8"	17-9/16"	7-7/8"	32-9/32"	7/8"	1	✓
CAZ35	35"	90	3/8"	24-13/16"	7-7/8"	42-9/16"	7/8"	1	✓

Replacement

ITEM	MATERIAL	DIAMETER	FOR USE WITH	☞	AVAILABLE
RCAZP	Tungsten carbide	7/8"	CAZ24 y CAZ35	1	✓

BALL BEARINGS TILE CUTTER

PROFESSIONAL USE **9/32"-3/8" MAX. CUTTING THICKNESS** DIAGONAL CUT **BALL BEARING**



• Ball-bearing slides reduce friction for smoother, more precise cutting.

16"



123147

SURTEK TOOLS FOR PROFESSIONALS



NEW



RCZ1

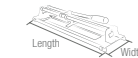

- Reinforced steel sheet base for greater rigidity and stability.
- Solid steel rails prevent bending and ensure precise alignment.
- Raised, graduated ruler for accurate and easy measurement during cutting.

ITEM	CUTTING LENGTH		THICKNESS CUT	DIAGONAL CUT	BASE WIDTH	TOTAL LENGTH	CUTTING WHEEL DIAMETER	☞	AVAILABLE
	IN	CM							
123147	16"	40.6	3/8"	11-3/16"	7"	23-1/4"	7/8"	1	On Request
CZ16	16"	40.6	9/32" - 3/8"	18-13/32"	6-1/2"	23-1/4"	7/8"	1	On Request
CZ20	20"	51	9/32" - 3/8"	14-3/16"	6-1/2"	25-5/8"	7/8"	1	On Request
CZ23	24"	61	9/32" - 3/8"	16"	6-1/2"	31-7/32"	7/8"	1	On Request
CZ26	26"	66	9/32" - 3/8"	18-13/32"	6-1/2"	33-5/8"	7/8"	1	On Request

Replacement

ITEM	MATERIAL	DIAMETER	FOR USE WITH	☞	AVAILABLE
RCZ1	Tungsten carbide	7/8"	CZ16, CZ20, CZ23 y CZ26	1	On Request
RCZ2	Tungsten carbide	7/8"	CZ16, CZ20, CZ23 y CZ26	1	On Request

REINFORCED TILE CUTTER

GENERAL USE **3/8" MAX. CUTTING THICKNESS** STRAIGHT CUT DIAGONAL CUT **LIGHT-WEIGHT**



- Reinforced base for increased stability and durability.
- Sliding system with bushings for smooth, controlled movement.
- Raised, graduated ruler for precise and easy measurement.
- Designed for consistent, accurate cuts on ceramic and porcelain tiles.

16"



CAZ16

SURTEK TOOLS FOR PROFESSIONALS



RCAZR

Two pieces per package.



ITEM	CUTTING LENGTH		THICKNESS CUT	DIAGONAL CUT	BASE WIDTH	TOTAL LENGTH	CUTTING WHEEL DIAMETER	☞	AVAILABLE
	IN	CM							
CAZ16	16"	40.6	3/8"	11-1/32"	5-17/32"	21-11/16"	19/32"	1	✓
CAZ20	20"	50.8	3/8"	13-7/8"	5-17/32"	25-5/8"	19/32"	1	✓

Replacement

ITEM	MATERIAL	DIAMETER	FOR USE WITH	☞	AVAILABLE
RCAZR	Tungsten carbide	15 mm	CAZ16 y CAZ20	1	✓

## TILE CUTTERS

### CUTTER TILE PLIER



- Designed for cutting tile, glass, ceramics, and clay materials.
- Ideal for trimming, shaping, and finishing edges with precision.
- Durable forged jaws provide clean cuts and long service life.
- Perfect for detailed or curved cuts during tile installation work.



### TILE SPACERS



123202



123203

- Ensure uniform spacing between tiles for professional-looking grout lines.
- Reusable and durable for multiple installation projects.
- Ideal for ceramic, porcelain, and stone tile applications.



ITEM	TOTAL LENGTH	AVAILABILITY
123160	8"	1 On Request

ITEM	DIMENSIONS	PIECES PER PACKAGE	AVAILABILITY
123202	5/64"	200	6 On Request
123203	1/8"	150	6 On Request
123205	13/64"	100	6 On Request
123206	15/64"	75	6 On Request
123208	5/16"	50	6 On Request

## BIMATERIAL HANDLE FLEXIBLE PUTTY KNIVES

### BIMATERIAL HANDLE FLEXIBLE PUTTY KNIVES



652X



653X



654X

- Non-shedding stainless blade leaves no metallic residue ideal for humid or high-hygiene environments.
- Highly resistant to rust and corrosion for longer service life.
- Ergonomic bi-material handle with metal end cap allows light tapping.
- Perfect for applying, spreading, or scraping compounds and sealants.

PUTTY KNIVES SET		
ITEM	6501X	6500X
PIECES	4	3
PACKING		
BULK	1	1
AVAILABILITY	✓	On Request
	•	•
	•	•
	•	•
	-	-
	•	-

### BIMATERIAL HANDLE FLEXIBLE PUTTY KNIVES



123033

- High flexibility and strength without losing shape during use.
- Neoprene and polypropylene handle provides a comfortable, secure, non-slip grip.

ITEM	SIZE	AVAILABILITY
123032	2"	6 On Request
123033	3"	6 On Request
123034	4"	6 On Request
123035	5"	6 On Request
123036	6"	6 On Request

### BIMATERIAL HANDLE STIFF PUTTY KNIVES



123023

- Ideal for scraping and heavy-duty applications.
- Neoprene and polypropylene handle provides a comfortable and secure non-slip grip.
- Rigid blade delivers maximum control and durability for demanding surface preparation work.

ITEM	SIZE	AVAILABILITY
123022	2"	6 On Request
123023	3"	6 On Request

### BIMATERIAL HANDLE TAPING KNIVES



- To flatten paper tapestry.
- To cover gaps with mixture in walls.



123110

- Smooth, burr-free finish prevents marks or surface damage during application.
- Wide blade covers large areas efficiently, reducing work time.
- Neoprene and polypropylene handle provides a comfortable, secure, non-slip grip.

ITEM	SIZE	AVAILABILITY
123108	8"	3 On Request
123110	10"	3 On Request
123112	12"	3 On Request

WOOD HANDLE FLEXIBLE PUTTY KNIVES

WOOD HANDLE FLEXIBLE PUTTY KNIVES



123104

- High flexibility and strength without losing shape during use.
- Polished wooden handle offers a comfortable and natural grip for better control.

**BULK**

ITEM	SIZE	AVAILABILITY
123101	1"	On Request
123102	2"	On Request
123103	3"	On Request
123104	4"	On Request
123105	5"	On Request
123106	6"	On Request

WOOD BIMATERIAL STIFF PUTTY KNIVES



123083

- Allows comfortable work on edges, joints, and irregular surfaces.
- Polished wooden handle offers a comfortable and natural grip for better control.

**BULK**

ITEM	SIZE	AVAILABILITY
123081	1"	On Request
123082	2"	On Request
123083	3"	On Request

WOOD HANDLE 5 IN 1 PUTTY KNIFE WITH SCRAPER

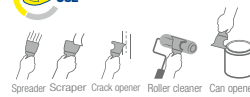

- Versatile multi-purpose tool—ideal for scraping, grooving, cleaning rollers, and applying putty or filler.
- Polished wooden handle offers a comfortable and natural grip for better control.

**BULK**

ITEM	SIZE	AVAILABILITY
123092	2-1/2"	On Request

WOOD HANDLE STIFF ANGLED PUTTY KNIFE



- Angled blade allows easier access to uneven surfaces

**BULK**

ITEM	SIZE	AVAILABILITY
123093	3"	On Request

FLOATS

WOOD HANDLE SPONGE FLOAT



123190



123193

- High water retention capacity for efficient cleaning and finishing.
- Ideal for rough finishes on cement, plaster, or mortar surfaces.
- Kiln-dried wooden handle provides a comfortable grip and long-lasting durability.
- Perfect for grouting, smoothing, and final surface touch-ups.

**BULK**

ITEM	FINISH	SIZE	THICKNESS	AVAILABILITY
123190	Rough	9-1/2" x 4"	3/4"	On Request
123193	Rough	12" x 4"	1/2"	On Request

PLASTIC HANDLE SPONGE FLOAT



- High water retention capacity for efficient cleaning and finishing.
- Ideal for rough finishes on cement, plaster, and mortar surfaces.
- Perfect for grouting and joint finishing applications.
- Lightweight plastic handle provides comfort and easy handling during extended use.

**BULK**

ITEM	FINISH	SIZE	THICKNESS	AVAILABILITY
123197	Rough	9-1/2" x 4"	3/4"	On Request

WOOD HANDLE RUBBER FLOAT



123198



123192

- Ideal for fine finishing on cement and plaster, providing a smooth, polished surface.
- Durable rubber pad ensures uniform pressure and consistent results.
- Kiln-dried wooden handle offers a comfortable, secure grip.
- Perfect for professional masonry and plastering applications.

**BULK**

ITEM	FINISH	SIZE	THICKNESS	AVAILABILITY
123198	Fine	9-1/2" x 4"	5/8"	On Request
123192	Smooth	9-1/2" x 4"	5/8"	On Request

PLASTIC HANDLE RUBBER FLOAT



123189



123191

- Designed for fine finishing on cement and plaster, achieving a smooth, polished surface.
- Durable rubber pad ensures even pressure and consistent results.
- Lightweight plastic handle provides comfort and easy maneuverability.
- Ideal for professional finishing work in construction and remodeling.

**BULK**

ITEM	FINISH	SIZE	THICKNESS	AVAILABILITY
123189	Fine	9" x 4"	7/16"	On Request
123191	Fine	9-1/2" x 4"	5/8"	On Request

## STEEL FISH TAPES

### STEEL FISH TAPES



GJ15

URREA



- Wire size: 1/16" x 1/8", made of SAE 1045 high-carbon steel for superior strength and flexibility.
- High-impact plastic housing provides long-lasting durability.
- Bi-directional reel design allows one-hand operation for easier handling.
- Inspection window lets you check the amount of tape deployed at any time. Large guide head for faster and easier wire feeding and measuring.



ITEM	MAXIMUM LENGTH	REEL DIAMETER	⊞	AVAILABLE
GJ15	48 ft 15 m	8-1/2" 216 mm	1	✓
GJ30	96 ft 30 m	12" 304 mm	1	✓
GJ60	192 ft 60 m	12" 304 mm	1	✓

### STEEL FISH TAPES



112600

SURTEK



- Wire size: 1/16" x 1/8", made of SAE 1045 steel for high strength and flexibility.
- Bi-directional reel design allows smooth one-hand operation.
- Inspection window lets you easily check the length of tape deployed.



ITEM	MAXIMUM LENGTH	REEL DIAMETER	⊞	AVAILABLE
112600	48 ft 15 m	8-1/2" 216 mm	1	On Request
112601	96 ft 30 m	12" 304 mm	1	On Request
112602	192 ft 60 m	12" 304 mm	1	On Request

## NOTCHED HAND TROWELS

### PLAIN NOTCHED HAND TROWELS



123180



123186



123183



- Designed for spreading and finishing mortar, concrete, and plaster on walls and ceilings.

- Made of hardened, mirror-polished high-carbon steel for superior durability and performance.
- Corrosion-resistant finish extends tool life.
- Blade size: 11" x 5".
- Ideal for professional masonry and finishing applications.

SURTEK



BULK

ITEM	HANDLE	RIVETS	⊞	AVAILABLE
123186	Plastic	6 3	3	On Request
123183	Wood	6 3	3	On Request
123180	Wood	10 3	3	On Request

### "V" NOTCHED HAND TROWELS



123181



123187



123184



- Notched edge ideal for applying adhesive on floors and small tiles.

- Made of hardened, mirror-polished high-carbon steel for superior durability and performance.
- Corrosion-resistant finish extends tool life.
- Blade size: 11" x 5".
- Ideal for professional masonry and finishing applications.

SURTEK



BULK

ITEM	HANDLE	RIVETS	⊞	AVAILABLE
123187	Plastic	6 3	3	On Request
123184	Wood	6 3	3	On Request
123181	Wood	10 3	3	On Request

### SQUARE NOTCHED HAND TROWELS



123182

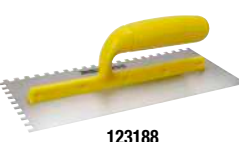

123188



123185



- Notched edge designed for applying mortar or other adhesives on natural stone and ceramic tiles, wall cladding, and large floor tiles.

- Made of hardened, mirror-polished high-carbon steel for superior durability and performance.
- Corrosion-resistant finish extends tool life.
- Blade size: 11" x 5".
- Ideal for professional masonry and finishing applications.

SURTEK



BULK

ITEM	HANDLE	RIVETS	⊞	AVAILABLE
123188	Plastic	6 3	3	On Request
123185	Wood	6 3	3	On Request
123182	Wood	10 3	3	On Request



CAULKING GUN

CAULKING GUN

- HEAVY DUTY
- ROTATING BARREL
- NON-DRIP
- LIGHT-WEIGHT
- HOOK
- CUTTER
- POKER
- STRONG BUILD

URREA



VIDEO



- Made of reinforced steel sheet.
- Drip-free.
- Force ratio 18:1.
- 40% lighter.
- Can be disassembled for cleaning and maintenance.
- Due to its high thrust ratio, it is used for high-viscosity silicones, PE adhesives, and specialized construction sealants, among other industries.

BULK

ITEM	DESCRIPTION	AVAILABILITY
PSFU1	Caulking gun	1 ✓

CAULKING GUNS

PROFESSIONAL USE



PSF3

- Steel plunger rod with hexagonal section for improved ratchet performance.
- Made of die-cast aluminum.
- Corrosion resistant.



- Includes practical puncture tool for opening silicone tubes.



- Hook-shaped rod end for convenient gun hanging.

- All Surtek caulking guns:
- Use standard cartridges: 8-1/2" x 2" (216 x 50 mm).
- Double-riveted handle.
- Built with steel tensioners

PROFESSIONAL USE



PSF35

- Made of steel.
- Corrosion resistant.

PROFESSIONAL USE



PSF4

- Made of steel with skeleton-type frame.
- Rotating barrel for better access in confined spaces.
- Reinforced handle with "T"-shaped structure.
- Corrosion resistant.

MASTER USE



VIDEO



NEW



PSF5

- Double push rod for special cartridges.
- Corrosion resistant.

BULK

ITEM	DESCRIPTION	AVAILABILITY
PSF3	Professional	6 On Request
PSF35	Caulking gun with reinforced rack	6 On Request
PSF4	Reinforced	6 On Request
PSF5	Double rod	6 On Request

GROOVER AND DUMPER

ALUMINUM GROOVING

PROFESSIONAL USE



- Made of one-piece aluminum to avoid detachment of the handle.
- Useful for marking on edges and shores.
- Useful in making sidewalks.

BULK

ITEM	DESCRIPTION	AVAILABILITY
123195	Groover	6 On Request

ALUMINUM DUMPER

PROFESSIONAL USE



- Made of one-piece aluminum to avoid detachment of the handle.
- Useful to eliminate edges and edges leaving rounded finishes.
- Useful in making sidewalks.

BULK

ITEM	DESCRIPTION	AVAILABILITY
123194	Dumper	6 On Request

## PAINT BRUSHES



### PAINT BRUSHES WITH INDUSTRIAL PLASTIC HANDLE



123136

- Maximum-density natural bristles for balanced flexibility and control.
- Excellent paint retention for smooth, uniform finishes.
- Solvent-resistant bristles for longer service life.
- Ideal for use with oil-based paints, varnishes, and stains.

ITEM	WIDTH	BRISTLE LENGTH	THICKNESS	⊞	AVAILABLE
123132	1-1/2"	1-7/8"	7/16"	6	On Request
123133	2"	1-7/8"	15/32"	6	On Request
123135	3"	2"	1/2"	6	On Request
123136	4"	2-9/32"	5/8"	6	On Request
123137	5"	2-9/16"	11/16"	6	On Request
123138	6"	2-9/16"	11/16"	6	On Request

### NATURAL BRISTLE PAINT BRUSHES



123316

- Medium-density natural bristles for balanced flexibility and control.
- Excellent paint retention for smooth, uniform finishes.

ITEM	WIDTH	BRISTLE LENGTH	THICKNESS	⊞	AVAILABLE
123310	1/2"	40 mm	7.7 mm	6	✓
123311	1"	40 mm	7.8 mm	6	✓
123312	1-1/2"	40 mm	10 mm	6	✓
123313	2"	40 mm	10 mm	6	✓
123314	2-1/2"	44 mm	10.7 mm	6	✓
123315	3"	44 mm	13.5 mm	6	✓
123316	4"	47 mm	15 mm	6	✓
123317	5"	54 mm	17.9 mm	6	✓
123318	6"	60 mm	18 mm	6	✓

### IXTLE FIBER BRUSHES WITH PLASTIC HANDLE



123377

- Ideal for applying coatings on rough surfaces, such as waterproofing compounds and other thick materials.
- Natural ixtle fibers provide excellent stiffness and durability for heavy-duty applications.
- Plastic handle offers a firm, comfortable grip and resists moisture and chemicals.

ITEM	WIDTH	BRISTLE LENGTH	THICKNESS	⊞	AVAILABLE
123377	4"	88 mm	140 mm	6	✓
123378	5"	88 mm	145 mm	6	✓
123379	6"	90 mm	150 mm	6	✓

### PAINT BRUSHES



123351



123352



123353

- Ergonomic reinforced handle for better control and comfort during extended use.
- 100% synthetic filaments for excellent paint pickup, smooth application, and easy cleaning.



- Horsehair and synthetic filament blend ensures smooth, even coverage with minimal brush marks.
- Ergonomic handle provides comfort and control during prolonged use.
- Threaded handle compatible with extension poles for greater reach and versatility.

- Made with 100% natural ixtle fiber bristles for excellent stiffness and durability.
- Threaded handle compatible with extension poles for extended reach.

**BULK**

ITEM	DESCRIPTION	DIMENSIONS	BRISTLES LENGTH (A)	BRISTLES (B X C)	⊞	AVAILABLE
123351	Synthetic bristles	93 x 160 mm	45 mm	7 x 14	4	✓
123352	Mixed bristles	93 x 160 mm	38 mm	7 x 14	4	✓
123353	Natural bristles	64 x 255 mm	50 mm	5 x 21	4	✓

### BRUSH HANDLE



- Varnished wooden handle for durability and protection against moisture.
- Smooth finish provides a comfortable and secure grip.

**BULK**

ITEM	LENGTH	⊞	AVAILABLE
CAB43	48"	1	✓

### PAINT MIXERS



123349

- Designed for mixing all types of paints, pastes, adhesives, fillers, cement compounds, and more.
- Quiet, self-controlled operation for smooth and consistent mixing.
- Ideal for professional painters, contractors, and maintenance work.

**BULK**

ITEM	SIZE	⊞	AVAILABLE
123349	2 x 15"	1	On Request
123350	4 x 29"	1	On Request

### PAINT ROLLER KIT



**3 PIECES**



Content	
Base for 10.4" x 4.1" rollers	1
9" roller handle	1
Replacement for 9" rollers	1

- For large surfaces

ITEM	DESCRIPTION	⊞	AVAILABLE
123361	Paint roller kit 3 pieces	1	✓

BRUSHES, ROLLERS AND PAINTING ACCESSORIES

POLYESTER PAINT ROLLERS



- Suitable for all types of surfaces and finishes.
- Premium combed pile with trimmed edges for optimal paint coverage and smooth application.
- Resistant to all types of solvents for extended durability.
- Delivers excellent finish quality and consistent performance on walls and ceilings.
- Handle includes threaded end compatible with extension poles for greater reach and convenience



NEW

ITEM	LENGTH	THICKNESS	SURFACE USE	☑	AVAILABLE
123356	4"	3/4"	Rough	1	✓
123383	7"	5/8"	Rough	1	✓
123340	9"	3/8"	Smooth	1	✓
123381	9"	5/8"	Rough	1	✓
123341	9"	3/4"	Rough	1	✓
123382	9"	9"	Extra Rough	1	✓
123342	9"	1-1/4"	Extra Rough	1	✓
123380	12"	5/8"	Rough	1	✓

Polyester paint rollers replacements

ITEM	FOR ITEM	LENGTH	THICKNESS	SURFACE USE	☑	AVAILABLE
123357	123356	4"	3/4"	Rough	1	✓
123387	123383	7"	5/8"	Rough	1	✓
123343	123340	9"	3/8"	Smooth	1	✓
123385	123381	9"	5/8"	Rough	1	✓
123344	123341	9"	3/4"	Rough	1	✓
123386	123382	9"	1"	Extra Rough	1	✓
123345	123342	9"	1-1/4"	Extra Rough	1	✓
123384	123380	12"	5/8"	Rough	1	✓

MICROFIBER PAINT ROLLERS



- Ideal for achieving a fine, smooth finish on walls and ceilings.
- Drip- and splatter-resistant design ensures efficient paint application and reduced waste.
- Handle includes threaded end compatible with extension poles for extended reach.
- Excellent paint absorption and release for professional-quality results.



NEW

ITEM	LENGTH	THICKNESS	SURFACE USE	☑	AVAILABLE
123392	9"	3/8"	Smooth	1	✓

Polyester paint rollers replacement

ITEM	LENGTH	THICKNESS	SURFACE USE	☑	AVAILABLE
123396	9"	3/8"	Smooth	1	✓

PVC PAINT ROLLERS



- Ideal for applying texture and achieving a stucco-like finish in a single application.
- Solvent-resistant construction ensures durability and long service life



NEW

ITEM	LENGTH	THICKNESS	SURFACE USE	☑	AVAILABLE
123395	9"	7/16"	For textured/rough surfaces	1	✓

PVC roller replacement

ITEM	LENGTH	THICKNESS	SURFACE USE	☑	AVAILABLE
123399	9"	7/16"	For textured/rough surfaces	1	✓

SPONGE PAINT ROLLERS



- Ideal for large surfaces its absorbent texture covers more area with each paint load.
- Perfect for smooth surfaces, ceilings, concrete, and block walls.
- Provides even coverage and reduces paint waste.
- Lightweight and easy to clean for repeated use. Handle includes threaded end compatible with extension poles for greater reach and convenience.



NEW

ITEM	LENGTH	THICKNESS	SURFACE USE	☑	AVAILABLE
123389	4"	3/8"	Smooth	1	On Request
123393	9"	3/8"	Smooth	1	✓
123394	9"	3/4"	Rough	1	✓

Repuestos de rodillos para pintar de esponja

ITEM	FOR ITEM	LENGTH	THICKNESS	☑	AVAILABLE
123391	123389	4"	3/8"	1	✓
123397	123393	9"	3/8"	1	✓
123398	123394	9"	3/4"	1	✓

NYLON PAINT ROLLERS



- Ideal for detailed areas where a smooth, fine finish is required.
- Drip- and splatter-resistant for cleaner, more efficient painting.
- Provides excellent paint pickup and release for uniform coverage.



NEW

ITEM	LENGTH	THICKNESS	SURFACE USE	☑	AVAILABLE
123388	4"	3/8"	Smooth	1	On Request

Polyester paint rollers replacement

ITEM	LENGTH	THICKNESS	SURFACE USE	☑	AVAILABLE
123390	4"	3/8"	Smooth	1	✓

PAINT ROLLER FRAMES



- Professional handle with steel frame and reinforced threaded socket for extension poles.
- Compatible with all standard roller refills.



NEW

ITEM	DESCRIPTION	☑	AVAILABLE
123299	Handle for 4" rollers w-o frame	1	✓
123298	Handle frame for 4" rollers	1	✓
123346	Handle frame for 9" rollers	1	✓
123297	Reinforced handle frame for 9" rollers	1	✓

CONSTRUCTION TOOLS

## BRUSHES, ROLLERS AND PAINTING ACCESSORIES

### PAINT TELESCOPIC EXTENSIONS



- Steel body for strength and durability.
- Threaded tip securely fits paint rollers and accessories.
- Adjustable length provides extended reach for walls and ceilings



### PAINT TRAY



- Specially designed to optimize paint loading and reduce waste.
- Extra-rigid walls provide strength and stability during use.
- Textured rolling area ensures even paint distribution on the roller.



ITEM	LENGTH	☐	AVAILABLE
CAB55	3,9'	1	✓
CAB56	7,9'	1	✓

ITEM	DIMENSIONS	☐	AVAILABLE
123347	14" x 11"	1	✓

### MASKING TAPE

#### BLUE MASKING TAPE



CIM02



- Made of crepe paper.
- Synthetic rubber-based adhesive prevents tape from peeling off or paint from seeping through, ensuring higher precision.
- Medium adhesion.
- Easily removable after use.
- Leaves no residue and does not damage the surface.
- UV resistant.
- Masking tape for both interior and exterior applications on multiple surfaces.

ITEM	OVERALL DIAMETER	INNER DIAMETER	WIDTH	LENGTH	THICKNESS	☐	AVAILABLE
CIM01	4,3"	3"	1"	164 ft	0,005"	1	On Request
CIM02	4,3"	3"	1,5"	164 ft	0,005"	1	On Request
CIM03	4,3"	3"	2"	164 ft	0,005"	1	✓

#### BLUE MASKING TAPE



138080



- Made of crepe paper.
- Low adhesion.
- Acrylic emulsion adhesive.
- Masking tape for both interior and exterior applications on multiple surfaces.

ITEM	OVERALL DIAMETER	INNER DIAMETER	WIDTH	LENGTH	THICKNESS	☐	AVAILABLE
138080	4,8"	3"	0,5"	164 ft	0,006"	6	On Request
138081	4,8"	3"	0,75"	164 ft	0,006"	6	On Request
138082	4,8"	3"	1"	164 ft	0,006"	6	On Request
138083	4,8"	3"	1,5"	164 ft	0,006"	6	On Request
138084	4,8"	3"	2"	164 ft	0,006"	6	On Request

#### HIGH TEMPERATURE MASKING TAPE



CIM06



- Made of crepe paper.
- Withstands high temperatures up to 95 °C for 30 minutes without losing adhesion or leaving residue.
- Medium-high adhesion.
- Synthetic rubber-based adhesive.
- UV resistant.
- Masking tape for both interior and exterior applications on multiple surfaces.

ITEM	OVERALL DIAMETER	INNER DIAMETER	WIDTH	LENGTH	THICKNESS	☐	AVAILABLE
CIM06	4,3"	3"	2"	164 ft	0,005"	1	On Request

#### MASKING TAPES



138030



- Made of crepe paper.
- Low adhesion.
- Resin rubber-based adhesive.
- Masking tape for both interior and exterior applications on multiple surfaces

ITEM	OVERALL DIAMETER	INNER DIAMETER	WIDTH	LENGTH	THICKNESS	☐	AVAILABLE
138030	4,8"	3"	0,5"	164 ft	0,006"	6	On Request
138031	4,8"	3"	0,75"	164 ft	0,006"	4	On Request
138032	4,8"	3"	1"	164 ft	0,006"	3	On Request
138033	4,8"	3"	1,5"	164 ft	0,006"	2	On Request
138034	4,8"	3"	2"	164 ft	0,006"	2	On Request

### BUCKET OPENER

#### BUCKET OPENER



- Made of high-resistance polypropylene.
- Designed to open 19-liter and 1-gallon buckets.

ITEM	DIMENSIONS	☐	AVAILABLE
123354	7,9 x 2,4 x 0,8"	12	On Request



usa.urrea.com



CLASS	TYPER	PAGE	BRAND	
			URREA	SURTEK
Personal protective equipment	Soldering iron tool set	604	•	
	Personal protective equipment sets	604	•	•
	Delivery drivers sets	604		•
	Welding helmets and goggles	605	•	•
	Safety helmets	606	•	•
	Safety glasses	607	•	•
	Ear protection	612	•	•
	Harness sets	613	•	
	Safety harnesses	613	•	•
	impact shock absorber	615	•	•
	Safety vests	617	•	•
	Welding clothing	623	•	•
	Back support belts	618	•	•
	Raincoats	620	•	•
	Knee pads	622	•	•
	Gloves	624	•	•
	Protective shoes	629	•	•
Signaling	Anti-slip tape	631		•
	Safety tape	631		•
	Cones	632		•
	Parking stops	632		•
	Reflective triangles	632		•

[usa.urrea.com](http://usa.urrea.com)

We are constantly improving our products, that is why the information, characteristics and availability of them can change without prior notice.

## PERSONAL PROTECTIVE EQUIPMENT SETS

### WELDING PERSONAL PROTECTIVE EQUIPMENT SET



**6**  
PIECES



Content	
USCS4	Electric Welding Helmet Smooth Design 1
USS1	Split Leather Apron 1
USS3	Split Leather Sleeves 1
USGLS	Welding Leather Gloves One Size 1
ESQZ20	Magnetic Multi Angle Welding Corner 20 lb 2

ITEM	PIECES	AVAILABLE
JPS6	6	On Request



### PROFESSIONAL BASIC PERSONAL PROTECTIVE EQUIPMENT SETS



**4**  
PIECES

**M**  
SIZE



Content -JPM4-	
USH01W	Safety Helmet With Ratcheting Adjustment White 1
USL005	Zeus Model Safety Glasses Transparent 1
USCH11	Red Safety Vest - Size M 1
UST01	Reusable Earplugs 1

ITEM	PIECES	VEST SIZE	AVAILABLE
JPM4	4	M	1 ✓

**L**  
SIZE



Content -JPG4-	
USH01W	Safety Helmet With Ratcheting Adjustment White 1
USL005	Zeus Model Safety Glasses Transparent 1
USCH12	Red Safety Vest - Size L 1
UST01	Reusable Earplugs 1

ITEM	PIECES	VEST SIZE	AVAILABLE
JPG4	4	L	1 ✓

**XL**  
SIZE



Content -JPK4-	
USH01W	Safety Helmet With Ratcheting Adjustment White 1
USL005	Zeus Model Safety Glasses Transparent 1
USCH13	Red Safety Vest - Size XL 1
UST01	Reusable Earplugs 1

ITEM	PIECES	VEST SIZE	AVAILABLE
JPK4	4	XL	1 ✓



### BASIC PINK PERSONAL PROTECTIVE EQUIPMENT SETS



**4**  
PIECES

**S**  
SIZE



Content -JPRC4-	
USH01W	Safety helmet with ratcheting adjustment white 1
USL008	Orion model safety glasses transparent with pink 1
USCH81	Pink Safety Vest - Size S 1
UST01	Reusable earplugs 1

ITEM	PIECES	VEST SIZE	AVAILABLE
JPRC4	4	S	1 ✓

**L**  
SIZE



Content -JPRG4-	
USH01W	Safety helmet with ratcheting adjustment white 1
USL008	Orion model safety glasses transparent with pink 1
USCH83	Pink Safety Vest - Size L 1
UST01	Reusable earplugs 1

ITEM	PIECES	VEST SIZE	AVAILABLE
JPRG4	4	L	1 ✓



### PERSONAL PROTECTIVE EQUIPMENT SET



**100% POLYESTER**

**6**  
PIECES

**M**  
SIZE



Content	
137660	Comfort Model Safety Glasses Transparent 1
137308	Yellow Ratchet Adjustment Safety Helmet 1
137376	Orange Mesh Safety Vest with Adjustable Strap 1
137347	Reusable Earplugs 1
GNNM	Nylon Gloves With Nitrile Coating Size M 1
BOL01	Fabric Drawstring Bag - 35 x 45 cm 1

ITEM	PIECES	AVAILABLE
JPB6	6	1 ✓



### COMBINED TOOL SETS FOR DELIVERY WORKERS



**3**  
PIECES

**8**  
SIZE



Content	
137527	Polyester Rain Suit Size L, 2 Piece 1
137566	Gardening PVC Boots #8 1
BOL01	Fabric Drawstring Bag - 35 x 45 cm 1

ITEM	PIECES	AVAILABLE
JR6	3	1 ✓

**9**  
SIZE



Content	
137527	Polyester Rain Suit Size L, 2 Piece 1
137567	Gardening PVC Boots #9 1
BOL01	Fabric Drawstring Bag - 35 x 45 cm 1

ITEM	PIECES	AVAILABLE
JR7	3	1 ✓

**10**  
SIZE



Content	
137527	Polyester Rain Suit Size L, 2 Piece 1
137568	Gardening PVC Boots #10 1
BOL01	Fabric Drawstring Bag - 35 x 45 cm 1

ITEM	PIECES	AVAILABLE
JR8	3	1 ✓



**WELDING HELMETS**

**WELDING HELMETS**

**9 - 13**  
SHADE LEVELS  
**WORKS WITH SOLAR CELLS & BATTERIES**



USC6



USC5



USC4

**URREA**  
TOOL FOR PROGRESS



- Ratchet Suspension Adjustment System.
- Sensitivity Control: Low / High via infinite dial.
- Grinding Mode.
- Low Battery Alarm.

ITEM	USC6	USC5	USC4
VIEWING AREA	3.8" x 2.4"	3.8" x 1.7"	3.6" x 1.6"
SWITCHING SPEED LIGHT TO DARK	0.04 ms	0.04 ms	0.04 ms
CLEAR STATE	4	4	4
UV PROTECTION	DIN16	DIN16	DIN16
CLEAR STATE	DIN4	DIN4	DIN4
RATCHET ADJUSTMENT	•	•	•
BATTERIES	Lithium batteries CR2450	Lithium batteries CR2450	Lithium batteries CR2032
SENSITIVITY EXTERNAL ADJUSTMENT	n/a	•	n/a
EXTERNAL TIME DELAY ADJUSTMENT	n/a	•	n/a
TILT ADJUSTMENT	5 positions	5 positions	5 positions
SENSITIVY MANUAL ADJUSTMENT	•	•	•
MANUAL DELAY TIME SETTING	•	•	•
FLIP-UP WINDOW	n/a	n/a	n/a
FLIP-UP WINDOW	n/a	n/a	n/a
☒	1	1	1
AVAILABLE	On Request	On Request	On Request



USC6R



**Welding lens spare**

ITEM	DESCRIPTION	FOR ITEM	FOR ITEM	FOR ITEM	☒	AVAILABLE
USC6R	Clear lens	•	-	-	6	On Request
USC5R	Clear lens	-	•	-	6	On Request
USC4R	Clear lens	-	-	•	6	On Request

**WELDING MASKS**

**9 - 13**  
SHADE LEVELS



CSS01



CSS02

**SURTEK**  
TOOL FOR PROGRESS



- Ratchet Suspension Adjustment.
- Sensitivity Control: Low / High via Infinite Dial.
- Grinding Mode.
- Low Battery Alarm.

- Ratchet Suspension Adjustment.
- Sensitivity Control: Low / High via Infinite Dial.
- Grinding Mode.

ITEM	CSS01	CSS02
VISION SIZE	3.85" x 1.69"	3.6" x 1.65"
DARKENING SPEED	1/25,000 s	1/15,000 s
UV PROTECTION	DIN 16	DIN 16
CLEAR STATUS	DIN 4	DIN 4
ADJUSTMENT SHADES TYPE	Matraca	Matraca
SOLAR CEL	•	•
BATTERIES	Lithium batteries CR2450	Non-replaceable lithium battery
SHADOW CONTROL	Internal	External
TILT ADJUSTMENT	5 positions	5 positions
ARC SENSORS	2	2
FLIP-UP WINDOW	No	No
☒	1	1
AVAILABLE	On Request	On Request



137337



**Welding lens spare**

ITEM	DESCRIPTION	FOR ITEM	FOR ITEM	☒	AVAILABLE
137337	Dark lens	•	-	6	✓



## WELDING HELMETS

### WELDING HELMET WITH LENS HOLDER



10 - 14 SHADE LEVELS



137331

- Ratchet Suspension Adjustment.
- Made of Impact and Heat-Resistant Plastic.
- Panoramic Dark tint Polycarbonate Lens, Impact- and Splash Resistant.

SURTEK



NEW



137372



137327



ITEM	137331
VIEWING AREA	107 x 87 mm
DARKENING SPEED	-
UV PROTECTION	DIN 16
CLEAR STATE	-
ADJUSTMENT TYPE	Ratchet
SOLAR PANEL	-
BATTERIES	-
SHADE CONTROL	Replaceable Lens
TILT ADJUSTMENT	5 positions
MOBILE ARC SENSORS	-
SLIDING WINDOW	No
AVAILABLE	On Request

### WELDING HELMET REPLACEMENTS

ITEM	LEVEL	DESCRIPTION	FOR ITEM	AVAILABLE
137372	10 shades	Dark lens	137331	On Request
137328	11 shades	Dark lens	137331	On Request
137373	12 shades	Dark lens	137331	On Request
137374	14 shades	Dark lens	137331	On Request
137327	-	Clear lens	137331	On Request

### WELDING GLASSES



SURTEK



- Flip up lens.
- For electric welding.
- Respirator to reduce face pressure.



ITEM	LEVEL	AVAILABLE
137334	11 shades	On Request



- Includes clear and dark lens shade 6.
- For oxy acetylene welding.
- Headband adjustment.



ITEM	LEVEL	AVAILABLE
137321	6 shades	✓

## SAFETY HELMETS

### 6 POINT RATCHET SAFETY HELMETS



CLASS E TYPE 1

URREA



NEW



USH01R



USH01Y



- Ratchet adjustment with 6-point suspension.

- Made of high density polyethylene.
- Nylon harness for added comfort.
- Dielectric strength: 20,000 V.
- Exceeds standards: ANSI/SEA Z89.1-2014 and NOM-115-STPS-2009.



ITEM	COLOR	AVAILABLE
USH01Y	Yellow	✓
USH01R	Red	✓

### FULL-BRIM 4-POINT RATCHET SAFETY HELMET



CLASS E TYPE 1

URREA



NEW



- Made of high-density polyethylene
- Nylon harness for added comfort
- Dielectric strength: 20,000 V
- Exceeds standards: ANSI/SEA Z89.1-2014 and NOM-115-STPS-2009

PLASTIC BAG

ITEM	COLOR	AVAILABLE
USH04W	White	✓

### 4 POINT RATCHET STYLE SAFETY HELMETS



CLASS E TYPE 1

URREA



NEW



USH02R



USH02B



USH02W



- Interval adjustment with 6-point suspension.

- Made of high density polyethylene
- Nylon harness for added comfort
- Dielectric strength: 20,000 V
- Exceeds standards: ANSI/SEA Z89.1-2014 and NOM-115-STPS-2009

BULK

ITEM	COLOR	AVAILABLE
USH02B	Blue	✓
USH02W	White	✓
USH02R	Red	✓
USH02P	Pink	✓



**SAFETY HELMETS**

**RATCHET STYLE SAFETY HELMETS**



**CLASS E**  
TYPE 1



**NEW**



- Made of polyethylene.
- Nylon harness for added comfort.
- Ribbed design that disperses impact.
- Dielectric strength: 20,000 V.
- Meets standard: NOM-115-STPS-2009.



ITEM	COLOR	☐	AVAILABLE
137308	Yellow	1	✓
137309	Blue	1	✓
137310	White	1	✓
137311	Orange	1	✓
137312	Red	1	✓
137313	Green	1	✓

**SAFETY HELMETS WITH 4-POINT RATCHET SUSPENSION AND VENTILATION**



**CLASS C**  
TYPE 1



**NEW**



- Made of high-density polyethylene.
- Nylon suspension for greater comfort and durability.
- Stepped-rib design helps dissipate impact energy.
- Ventilated shell provides cooling airflow for added comfort.
- Complies with NOM-115-STPS-2009 standard.



ITEM	COLOR	☐	AVAILABLE
CASA	Yellow	1	✓
CASZ	Blue	1	✓
CASB	White	1	✓
CASN	Orange	1	✓
CASR	Red	1	✓
CASV	Green	1	✓

**POLYESTER STRAP CHIN STRAPS**



**NEW**



- Made of polyester strap.
- Universal polycarbonate hooks on the ends.
- With flexible TPE chin cup for models 137620 and 137621.
- Length: 40 cm.
- Compatible with any helmet featuring attachment holes.
- Adjustment hooks prevent helmet detachment.
- Washable.
- High-visibility color for models 137621 and 137623.

ITEM	DESCRIPTION	☐	AVAILABLE
137620	Black with chin strap	1	✓
137621	High-visibility with chin strap	1	✓
137622	Black without chin strap	1	✓
137623	High-visibility without chin strap	1	✓

**SAFETY GLASSES**

**CLEAN LENS**



Recommended for all-around activities.

**AMBER LENS**



The amber lens filters out the blue light, providing greater contrast. Recommended for inspection tasks.

**GRAY LENS**



Sunglass styles for outdoor work. Offers protection from excessive glare.

**SAFETY GLASSES.**

ALL URREA SAFETY GLASSES HAVE:

Meets ANSI Z87.1 standard. Certificate not available.

- ANTI-SCRATCH MATERIAL
- UV 100% PROTECTION
- IMPACT RESISTANCE
- ANTI-FOG TREATMENT
- POLYCARBONATE LENS
- LIGHT WEIGHT

**ECLIPSE MODEL**



**IMPACT RESISTANCE**



**UV 100% PROTECTION**



• Adjustable nylon cord on the temples.



• Soft, non-slip rubber nose pad.



ITEM	LENS COLOR	☐	AVAILABLE
USL010	Black	●	12 ✓

**TOP-VISION MODEL**



**IMPACT RESISTANCE**



**UV 100% PROTECTION**



**FALL ARREST CORD**



USL011



• Multi-position temples for better fit.



• Adjustable nylon cord on the temples.



USL012



• Non-slip rubber nose pad.



ITEM	LENS COLOR	☐	AVAILABLE
USL011	Clear	○	12 ✓

ITEM	LENS COLOR	☐	AVAILABLE
USL012	Black	●	12 ✓

## SAFETY GLASSES

### CRONOS MODEL

**URREA**  
HEAVY DUTY IMPACT RESISTANCE  
ANTI-SCRATCH MATERIAL UV 100% PROTECTION  
FALL ARREST CORD



- For normal light conditions.
- Meets ANSI/ISEA Z87.1-2015 standard.
- Certificate not available.

ITEM	LENS COLOR	FRAME	AVAILABLE
USL003	Clear	○ 12	✓

### POSEIDON MODEL

**URREA**  
HEAVY DUTY IMPACT RESISTANCE  
ANTI-SCRATCH MATERIAL UV 100% PROTECTION  
FALL ARREST CORD



- No marks or edges that obstruct vision.
- Meets ANSI/ISEA Z87.1-2015 standard.
- Certificate not available.

ITEM	LENS COLOR	FRAME	AVAILABLE
USL004	Clear	○ 12	✓

### ORION MODEL

**URREA**  
HEAVY DUTY IMPACT RESISTANCE ANTI-SCRATCH MATERIAL UV 100% PROTECTION  
FALL ARREST CORD



- USL006
- Vertically adjustable, soft temples provide greater comfort.

- Ideal for high-brightness environments.
- Meets ANSI/ISEA Z87.1-2015 standard.
- Certificate not available.

ITEM	LENS COLOR	FRAME	AVAILABLE
USL006	Black	● ● 12	✓



USL008

ITEM	LENS COLOR	FRAME	AVAILABLE
USL008	Clear	○ ● 12	On Request

### APOLO MODEL

**URREA**  
HEAVY DUTY IMPACT RESISTANCE  
ANTI-SCRATCH MATERIAL UV 100% PROTECTION  
FALL ARREST CORD



- Improve definition.
- Ideal for low-light environments.
- Meets ANSI/ISEA Z87.1-2015 standard.
- Certificate not available.

ITEM	LENS COLOR	FRAME	AVAILABLE
USL007	Amber	● 12	✓

### ACTIVE MODEL

**URREA**  
HEAVY DUTY IMPACT RESISTANCE ANTI-SCRATCH MATERIAL UV 100% PROTECTION  
FALL ARREST CORD

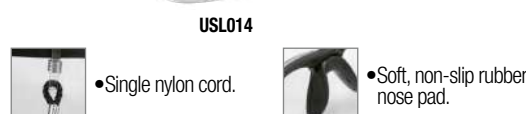

- Meets ANSI/ISEA Z87.1-2015 standard.
- Certificate not available.

ITEM	LENS COLOR	FRAME	AVAILABLE
USL014	Clear	○ 12	✓



USL015

ITEM	LENS COLOR	FRAME	AVAILABLE
USL015	Black	● 12	✓

### UNIVERSAL MODEL

**URREA**  
HEAVY DUTY IMPACT RESISTANCE ANTI-SCRATCH MATERIAL UV 100% PROTECTION  
FALL ARREST CORD



- Meets ANSI/ISEA Z87.1-2015 standard.
- Certificate not available.

ITEM	LENS COLOR	FRAME	AVAILABLE
USL019	Clear	○ 12	✓



ITEM	LENS COLOR	FRAME	AVAILABLE
USL020	Black	● 12	✓

### HADES MODEL

**URREA**  
HEAVY DUTY IMPACT RESISTANCE  
ANTI-SCRATCH MATERIAL UV 100% PROTECTION  
FALL ARREST CORD



- Filters 99% of UV rays.
- Made of polycarbonate.
- Meets ANSI/ISEA Z87.1-2015 standard.
- Certificate not available.

ITEM	LENS COLOR	FRAME	AVAILABLE
USL001	Black	● 12	✓

**SAFETY GLASSES**

**SPORT MODEL SAFETY GLASSES**



**ZEUS MODEL**



USL016



USL017



USL018



•Extendable legs for improved performance.



•Nose guard for increased safety and improved comfort.



•Adjustable-position legs for better fit.



•Soft, non-slip rubber nose pad.



•Adjustable nylon strap on the legs.

- Complies with standard: ANSI/ISEA Z87.1-2015.
- Certification not available.

- Single-lens eyewear.
- Complies with standard: ANSI/ISEA Z87.1-2015.
- Certification not available.

ITEM	LENS COLOR	AVAILABLE
USL016	Clear	12 ✓

ITEM	LENS COLOR	AVAILABLE
USL017	Amber	12 ✓

ITEM	LENS COLOR	AVAILABLE
USL018	Black	12 ✓

ITEM	LENS COLOR	AVAILABLE
USL005	Clear	12 ✓

**REINFORCED SAFETY GLASSES**



**NEW**

**REINFORCED**



137668



137669



137670

- Soft nose bridge for increased comfort.
- Meets ANSI/ISEA Z87.1-1989 standard.
- Certificate not available.

ITEM	COLOR	AVAILABLE
137668	Clear	6 On Request

ITEM	COLOR	AVAILABLE
137669	Black	6 On Request

ITEM	COLOR	AVAILABLE
137670	Amber	6 On Request

**SAFETY GLASSES COMFORT**



**COMFORT**



137660



137661



137662

- Adjustable temples.
- Soft nose bridge for increased comfort.
- Meets ANSI/ISEA Z87.1-1989 standard.
- Certificate not available.

ITEM	COLOR	AVAILABLE
137660	Clear	6 On Request

ITEM	COLOR	AVAILABLE
137661	Black	6 On Request

ITEM	COLOR	AVAILABLE
137662	Amber	6 On Request

## SAFETY GLASSES

### SAFETY GLASSES



#### PANORAMIC



137676



137677



137678

- Clean edges for increased field of vision.
- Meets ANSI/SEA Z87.1-1989 standard.
- Certificate not available.



ITEM	COLOR	AVAILABILITY	ITEM	COLOR	AVAILABILITY	ITEM	COLOR	AVAILABILITY
137676	Clear	On Request	137677	Black	On Request	137678	Amber	On Request

### ADJUSTABLE GLASSES



- With side protection and nose bridge.
- Meets ANSI/SEA Z87.1-1989 standard.
- Certificate not available.



### SAFETY GLASSES ADJUSTABLE



- Adjustable temples.
- Meets ANSI/SEA Z87.1-1989 standard.
- Certificate not available.



ITEM	COLOR	AVAILABILITY	ITEM	COLOR	AVAILABILITY
137326	Clear	On Request	137684	Black	On Request

### TRADITIONAL SAFETY GLASSES



137323



137324



137325

- Polycarbonate lenses.
- Comfortable nose bridge.
- Side ventilation.
- Suitable for use with power tools, industrial work, construction, workshops, and home projects.
- Standard: ANSI Z87.1-1989.



ITEM	COLOR	AVAILABILITY	ITEM	COLOR	AVAILABILITY	ITEM	COLOR	AVAILABILITY
137323	Clear	On Request	137324	Black	On Request	137325	Ámbar	On Request

**SAFETY GLASSES**

**SAFETY GOGGLES**



- Polycarbonate lenses with PVC frame.
- Anti-fog coating.
- Protects against flying particles, chemical splashes, sparks, etc.
- Adjustable elastic strap.
- Indirect ventilation via valves.
- Meets ANSI/SEA Z87.1-2015 standard.
- Certificate not available.



ITEM	COLOR	☞	AVAILABLE
USLG1	Clear	1	✓

**SAFETY GOGGLES WITH UV PROTECTION**



**NEW**



- Protects the user's eyes from coarse dust and splashes.
- Translucent PVC frame.
- Clear PETG C30 lens.
- 99% UV protection.
- TPE strap.



ITEM	COLOR	☞	AVAILABLE
GOS01	Clear	1	✓

**FACE MASK**



- Polycarbonate lens.
- Ratchet suspension adjustment.
- Designed to protect the face and neck.



ITEM	COLOR	☞	AVAILABLE
137305	Clear	2	On Request

**SAFETY GLASSES CLEAR**



- Polycarbonate lenses with PVC frame.
- Allows use with prescription glasses.
- Ventilation that reduces fogging.
- Head adjustment strap.



ITEM	COLOR	☞	AVAILABLE
137320	Clear	6	On Request

**ANATOMIC FACE SHIELD**



- Polycarbonate lens.
- Anatomical design to protect face, eyes, and neck.
- Polycarbonate visor with 90° flip-up.
- Meets ANSI/SEA Z87.1-2015 standard.
- Certificate not available.



ITEM	DESCRIPTION	☞	AVAILABLE
USFS1	Anatomic face shield	1	✓

**FACE MASK**



- 0.5 mm interchangeable PET lenses.
- Polypropylene frame.
- Protects the user against splashes.

**BOLSA**

ITEM	COLOR	☞	AVAILABLE
PFA02	Clear	1	✓

## EAR PROTECTION

### SELECTION AND PROPER USE OF HEARING PROTECTORS

Earplugs and earmuffs are PPE used to prevent damage to the user's hearing. They are used in very noisy environments or to prevent wind from entering the ear canal.

In Mexico, NOM-017-STPS-1993 mandates the use of hearing protectors when workers are exposed to sound levels equal to or greater than 85 dB.

For hearing protection to be effective, it must be worn 100% of the time in noisy environments.

#### ¿What types of earplugs are there?



Disposable earplugs are made of slow-recovery foam and provide comfort and protection. Once placed in the ear, the earplugs expand to the shape of each user.



Reusable earplugs are made of flexible, conical materials to fit the ear without having to be molded.



Earmuffs consist of cups filled with absorbent material and soft cushions that seal the ear to minimize noise.

#### ¿How to select the right hearing protector?

The most important factor is knowing the ambient noise in which it will be used, so that the risk of noise-induced hearing loss is minimal.

Protection should not be excessive. If the protected sound level is more than 15 dB below the desired value, the protector induces excessive attenuation, and the user is considered overprotected. It may be difficult to hear voices and warning signals, and the user will remove the protector when they need to communicate and check warning signs or will need to modify it to reduce its attenuation.

#### Decibel Table

Immediate Pain	SNR 35 dB	130 dBA	Fireworks
Mandatory protection	SNR 33 dB	120 dBA	Pneumatic hammer
Available protection	SNR 31 dB	110 dBA	Motor noise
Available protection	SNR 31 dB	100 dBA	Saw/drills
Non-hazardous noise	SNR 27 dB	130 dBA	Mechanical workshop
Non-hazardous noise	SNR 27 dB	130 dBA	Lawn mower
threshold normal		70 dBA	Warehouse
threshold normal		60 dBA	Fan



dBa [A-weighted decibel] is used to measure the noise level after filtering out high and low frequencies.

PPE Personal Protective Equipment

## EAR PROTECTION

**3 POSITIONS:** WORK, REST & REMOVE **(dB) NRR 30 DB NOISE REDUCTION LEVEL**



• Soft pads that act as a seal to minimize noise.



US02

- Folds easily for storage.
- Lightweight, adjustable, low-pressure headband.
- Meets ANSI S3.19-1974 standard.
- Certificate not available.

ITEM	DESCRIPTION	⊞	AVAILABLE
US02	Foldable & compact design ear protector	1	✓



• Soft pads that form a seal to minimize noise.



US03

- Adjustable to the helmet.
- Soft padding for increased comfort.
- Meets ANSI S3.19-1974 standard.
- Certificate not available.

ITEM	DESCRIPTION	⊞	AVAILABLE
US03	Ear protection for safety helmet	1	✓

## EARMUFFS

**PROFESSIONAL USE**  
**(dB) NRR 17 DB NOISE REDUCTION LEVEL**



- Adjustable to head size.
- Padded ear cups.

ITEM	DESCRIPTION	⊞	AVAILABLE
137345	GIRO Light earmuff for hearing protection	5	On Request

## REUSABLE EARPLUGS

**INDUSTRIAL DUTY** **(dB) NRR 27 DB NOISE REDUCTION LEVEL**

**REUSABLE**



- 4-layer mushroom style design with synthetic rubber for a perfect fit to the ear and reduced internal pressure.
- Nylon neck cord.
- Individually packed in bag and portable box.
- Meets ANSI S3.19-1974 standard.
- Certificate not available.

ITEM	DESCRIPTION	⊞	AVAILABLE
UST01	Reusable	60	✓

## DISPOSABLE EARPLUGS

**INDUSTRIAL DUTY** **MADE OF POLYURETHANE** **HIGH VISIBILITY** **HIPOALLERGENIC**

Use GENERAL



UST02

Use INDUSTRIAL



UST03

Anti VIBRATION



UST04

- Ergonomic high-density polyurethane design.
- Nylon neck cord.
- Individually packed in bag and portable box.
- Meets ISO 4869-2 standard.
- Certificate not available.

ITEM	DESCRIPTION	SINGLE NUMBER RATING	⊞	AVAILABLE
UST02	General use	SNR 32 dB	100	✓
UST03	Industrial use	SNR 32 dB	100	✓
UST04	Anti-vibration	SNR 33 dB	100	✓

## EARPLUGS

**PROFESSIONAL USE**  
**(dB) NRR 28 DB NOISE REDUCTION LEVEL**



- Ergonomic high-density polyurethane design.
- Nylon neck cord.

ITEM	DESCRIPTION	⊞	AVAILABLE
137347	Corded	12	✓

**HARNESSES**

**HARNESSES KITS**



**URREA**



**4**  
PIECES



USA01A

**5**  
PIECES



USA02A

Impact load limit 3,000 kg

- Dispose of after the first incident.
- Meets ANSI Z359.1 standard.
- Certificate available.

ITEM	DESCRIPTION	SIZE	⊞	AVAILABLE
USA01A	Harness kit, fall arrest	36-40	1	On Request
USA01B	Harness kit, fall arrest	40-44	1	On Request

ITEM	DESCRIPTION	SIZE	⊞	AVAILABLE
USA02A	Harness kit, positioning	36-40	1	On Request
USA02B	Harness kit, positioning	40-44	1	On Request

**HARNESSES**



**URREA**



**Positioning**



USA4A Simple



USA6A With belt

**High visibility fall protection**



- Sliding "D" ring.
- Stitching resistant to abrasion, UV rays, chemicals, and alkalis.



USA9A Simple

**Suspension**



USA7A With belt

**Rescue**



USA8A With belt

**Fall arrest**



USA3A Simple



USA5A With belt

- Dispose of after the first incident.
- Quick-connect buckle.
- Ring material: alloy steel.
- Meets ANSI Z359.1 standard.
- Certificate not available.

ITEM	HARNESSES TYPE	DESCRIPTION	SIZE	MAXIMUM CAPACITY	BAND WIDTH	TENSILE STRENGTH	"D" RING					⊞	AVAILABLE
							BACK	SIDES	CHEST	SHOULDERS			
USA9A	High visibility fall arrest	Simple	36-40	140 kg (308.6 lb)	1-3/4"	22.2 kN (4990.7 lb)	1	-	-	-	1	On Request	
USA9B	High visibility fall arrest	Simple	40-44	140 kg (308.6 lb)	1-3/4"	22.2 kN (4990.7 lb)	1	-	-	-	1	On Request	
USA3A	Falls arrest	Simple	36-40	140 kg (308.6 lb)	1-3/4"	22.2 kN (4990.7 lb)	1	-	-	-	1	On Request	
USA3B	Falls arrest	Simple	40-44	140 kg (308.6 lb)	1-3/4"	28 kN (6294.6 lb)	1	-	-	-	1	On Request	
USA5A	Falls arrest	With belt	36-40	140 kg (308.6 lb)	1-3/4"	28 kN (6294.6 lb)	1	-	-	-	1	On Request	
USA5B	Falls arrest	With belt	40-44	140 kg (308.6 lb)	1-3/4"	22.2 kN (4990.7 lb)	1	-	-	-	1	On Request	
USA4A	Positioning	Simple	36-40	140 kg (308.6 lb)	1-3/4"	22.2 kN (4990.7 lb)	1	2	-	-	1	On Request	
USA4B	Positioning	Simple	40-44	140 kg (308.6 lb)	1-3/4"	28 kN (6294.6 lb)	1	2	-	-	1	On Request	
USA6A	Positioning	With belt	36-40	140 kg (308.6 lb)	1-3/4"	22.2 kN (4990.7 lb)	1	2	-	-	1	On Request	
USA6B	Positioning	With belt	40-44	140 kg (308.6 lb)	1-3/4"	22.2 kN (4990.7 lb)	1	2	-	-	1	On Request	
USA7A	Suspension	With belt	36-40	140 kg (308.6 lb)	1-3/4"	28 kN (6294.6 lb)	1	2	1	-	1	On Request	
USA7B	Suspension	With belt	40-44	140 kg (308.6 lb)	1-3/4"	28 kN (6294.6 lb)	1	2	1	-	1	On Request	
USA8A	Rescue	With belt	36-40	140 kg (308.6 lb)	1-3/4"	22.2 kN (4990.7 lb)	1	-	-	2	1	On Request	
USA8B	Rescue	With belt	40-44	140 kg (308.6 lb)	1-3/4"	22.2 kN (4990.7 lb)	1	-	-	2	1	On Request	

## HARNESSES

### HARNESSES



NEW



- Dispose of after the first incident.
- With quick-connect buckles.
- Polyester webbing resistant to abrasion, chemicals, and ultraviolet rays.



ITEM	HARNESSES TYPE	SIZE	MAXIMUM CAPACITY	BAND WIDTH	TENSILE STRENGTH	"D" RING				☐	AVAILABLE
						BACK	SIDES	CHEST	SHOULDERS		
137422	Positioning	36-40	140 kg (308.6 lb)	1-3/4"	22.5 kN (2,300 kg)	1	2	-	-	1	On Request
137423	Positioning	40-44	140 kg (308.6 lb)	1-3/4"	22.5 kN (2,300 kg)	1	2	-	-	1	On Request
137420	Fall protection	36-40	140 kg (308.6 lb)	1-3/4"	22.5 kN (2,300 kg)	1	-	-	-	1	On Request
137421	Fall protection	40-44	140 kg (308.6 lb)	1-3/4"	22.5 kN (2,300 kg)	1	-	-	-	1	On Request
137424	Suspension	36-40	140 kg (308.6 lb)	1-3/4"	22.5 kN (2,300 kg)	1	2	1	-	1	On Request
137425	Suspension	40-44	140 kg (308.6 lb)	1-3/4"	22.5 kN (2,300 kg)	1	2	1	-	1	On Request
137426	Rescue	36-40	140 kg (308.6 lb)	1-3/4"	22.5 kN (2,300 kg)	1	-	-	2	1	On Request
137427	Rescue	40-44	140 kg (308.6 lb)	1-3/4"	22.5 kN (2,300 kg)	1	-	-	2	1	On Request

### ONE-SIZE HARNESSES



NEW



- Dispose of after the first incident.
- With quick-connect buckles.
- Polyester webbing resistant to abrasion, chemicals, and ultraviolet rays.
- Meets ANSI Z359.1 standard.
- Certificate not available.



ITEM	HARNESSES TYPE	SIZE	MAXIMUM CAPACITY	BAND WIDTH	TENSILE STRENGTH	"D" RING				☐	AVAILABLE
						BACK	SIDES	CHEST	SHOULDERS		
137441	Positioning	One size	140 kg (308.6 lb)	1-3/4"	22.5 kN (2,300 kg)	1	2	-	-	1	On Request
137440	Fall protection	One size	140 kg (308.6 lb)	1-3/4"	22.5 kN (2,300 kg)	1	-	-	-	1	On Request
137442	Suspension	One size	140 kg (308.6 lb)	1-3/4"	22.5 kN (2,300 kg)	1	2	1	-	1	On Request
137443	Rescue	One size	140 kg (308.6 lb)	1-3/4"	22.5 kN (2,300 kg)	1	-	-	2	1	On Request



Full-body harnesses are used for a wide variety of activities, from construction work to recreational activities. There are harnesses for falls, positioning, suspension, and more. It is important to identify the needs in the work environment to choose the appropriate harness.

Our harnesses meet the guidelines of ANSI A10.19/2359.1.

The use of this equipment is limited to the fall arrest system only; improper use of this equipment could result in serious injury or death.



IMPACT SHOCK ABSORBERS

IMPACT SHOCK ABSORBERS



USM2



USM1

- It is essential to consider the extension of the shock absorber when calculating fall distance.
- 1" flat webbing shock absorber.
- Reinforced stitching.
- Double-lock hooks.
- Tensile strength: 2,722 kg.
- Meets ANSI Z359.1 standard.
- Certificate not available.



ITEM	DESCRIPTION	TOTAL LENGTH	⊞	AVAILABLE
USM2	Nylon rope	72"	1	On Request
USM1	Polyester band	72"	1	On Request

LINEMEN'S POLE STRAP



- Round nylon rope, made with premium multifilament in both the core and outer layer, 5/8" (16 mm) in diameter.
- Forged steel double-lock hook for increased safety and ease of opening.
- Galvanized steel fastener with automatic locking system for easier adjustment.
- PVC coating protects the product.
- Equipment designed for electricians, linemen, telephone and cable workers, for use at heights above 1.80 meters (6 ft) from floor level, allowing the user to work with both hands free.



ITEM	MAXIMUM REACH	TOTAL LENGTH	⊞	AVAILABLE
USBL01	6.5 ft	6.5 ft	1	On Request

SECURITY CABLE



USCP1



USCR1

- 1/2" braided nylon positioning ropes.
- Length: 6 ft.
- 1-3/4" high-tensacity polyester webbing.
- Length: 35.4 in.
- Double-lock hooks.
- Meets ANSI Z359.1 standard.
- Certificate not available.



ITEM	DESCRIPTION	TOTAL LENGTH	⊞	AVAILABLE
USCP1	Nylon positioning lanyard	72"	1	On Request
USCR1	Suspension and confined space lanyard	35"	1	On Request

IMPACT SHOCK ABSORBER



NEW



- Integrated impact absorber that dissipates energy from a fall, with two 3/4" (19 mm) safety hooks at each end.
- Shock absorption system keeps fall force below 408 kg.



ITEM	DESCRIPTION	TOTAL LENGTH	⊞	AVAILABLE
137430	For suspension and rescue	70.8"	1	On Request

LINEMEN'S SAFETY BELT



- 1/2" wide nylon webbing.
- Double-lock hooks.
- Tensile strength: 2,272 kg.
- Reinforced stitching.
- Meets ANSI Z359.1 standard.
- Certificate not available.



ITEM	DESCRIPTION	TOTAL LENGTH	WIDTH	⊞	AVAILABLE
USBL2	Position strap adjustable lanyard.	70.8"	1/2"	1	On Request

SECURITY CABLE



NEW



- Made of 5/8" braided nylon.
- Two 3/4" (19 mm) safety hooks at each end.
- Tensile strength: 2,200 kg.



ITEM	DESCRIPTION	TOTAL LENGTH	⊞	AVAILABLE
137431	For positioning	70.8"	1	On Request

## IMPACT SHOCK ABSORBERS

### LINEMAN BELTS



USC01C

- Fits around the worker's waist. Includes 2 "D" rings for attaching the ends of the safety lanyard; padded interior and equipped with straps for carrying tools.
- Neoprene webbing for increased tensile strength.
- 4" nylon webbing for padding.
- 4 compartments.



ITEM	SIZE	TOTAL LENGTH	TOTAL RANGE	⊞	AVAILABLE
USC01C	36	42.5"	33.5"/39"	1	On Request
USC01M	40	46.1"	36.6"/42.5"	1	On Request
USC01G	44	47.2"	37.8"/44.1"	1	On Request

### SELF-RETRACTING LIFELINES



USLV2

USLV9



- Dispose of after the first incident.
- Designed to limit free-fall distance, deceleration, and arresting forces.
- Fall protection system.
- The self-retracting lifeline allows workers at height greater freedom of movement.
- Maximum extension of 60 cm once activated.

ITEM	LENGTH	BAND	CAPACITY	⊞	AVAILABLE
USLV2	7 ft	Dyneema band 1"	308 lb	1	On Request
USLV6	20 ft	Steel band 3/16"	308 lb	1	On Request
USLV9	30 ft	Steel band 3/16"	308 lb	1	On Request

### POSITIONING LINE



- Used in applications where the worker requires continuous protection while traversing long sections, both vertical and horizontal.
- Tensile strength: 2,268 kg.
- 5/8" rope diameter.
- Double-lock hooks.
- Length: 10 m (32.8 ft).
- Meets ANSI Z359.1 standard. Certificate not available.



ITEM	DESCRIPTION	TOTAL LENGTH	⊞	AVAILABLE
USLP1	Lifeline rope	32.8 ft	1	On Request

### ANCHOR SLING



- Fixed anchor point with ring.
- 1-3/4" wide webbing.
- High-tenacity polyester webbing.
- Tensile strength: 3,090 kg.
- Reinforced stitching.
- Length: 90 cm (35.4 in).
- Meets ANSI Z359.1 standard.



ITEM	DESCRIPTION	TOTAL LENGTH	⊞	AVAILABLE
USPF1	Anchor sling with reinforced seams	35.4"	1	On Request

### FIXED ANCHOR POINT



NEW



- Fixed point with ring.
- High-tenacity polyester webbing.
- Tensile strength: 2,200 kg.



ITEM	TOTAL LENGTH	⊞	AVAILABLE
137432	35.4"	1	On Request



**SAFETY VESTS**

**SUPERVISOR-TYPE SAFETY VESTS WITH REFLECTIVE STRIP**



**REFLECTIVE BAND**



**250 GSM COTTON FABRIC**

**6 OUTER & 2 INNER POCKETS**

**NEW**



USCH11



USCH81



Rear view

- 2" prismatic reflective strip on chest and back.
- Vest made of 250 g/m<sup>2</sup> cotton fabric, making it lightweight and comfortable for the user.
- 20" reinforced black front closure.



ITEM	SIZE	COLOR	☞	AVAILABLE
USCH11	Medium	●	1	✓
USCH12	Large	●	1	✓
USCH13	Extra large	●	1	✓
USCH14	Double extra large	●	1	✓
USCH21	Medium	●	1	✓
USCH22	Large	●	1	✓
USCH23	Extra large	●	1	✓
USCH24	double extra large	●	1	✓
USCH81	Small	●	1	✓
USCH82	Medium	●	1	✓
USCH83	Large	●	1	✓

**HIGH-VISIBILITY SUPERVISOR-TYPE SAFETY VESTS – CLOSED STYLE**



**POLYESTER MESH**



**REFLECTIVE BAND**

**7 MULTIFUNCTIONAL POCKETS**

**NEW**



137548



137549



Rear view

- Reflective bands.
- Made of polyester mesh.
- Front closure with metal snaps.



ITEM	SIZE	COLOR	☞	AVAILABLE
137548	One size	●	1	On Request
137549	One size	●	1	On Request

**SUPERVISOR-TYPE SAFETY VESTS WITH REFLECTIVE STRIP – OPEN STYLE**



**REFLECTIVE BAND**



**250 GSM COTTON FABRIC**

**6 OUTER & 2 INNER POCKETS**

**NEW**



USCH31



Rear view

- 2" prismatic reflective strip on chest and back.
- Vest made of 250 g/m<sup>2</sup> cotton fabric, making it lightweight and comfortable for the user.
- 6 adjustable side snaps.
- 20" reinforced black front closure.



ITEM	SIZE	COLOR	☞	AVAILABLE
USCH31	Medium	●	1	✓
USCH32	Large	●	1	✓
USCH33	Extra large	●	1	✓
USCH34	Double extra large	●	1	✓
USCH41	Medium	●	1	✓
USCH42	Large	●	1	✓
USCH43	Extra large	●	1	✓
USCH44	Double extra large	●	1	✓

**HIGH-VISIBILITY SAFETY VESTS HIGH-VISIBILITY SAFETY VESTS**



**HIGH VISIBILITY**



**100% POLYESTER FABRIC**

**3 POCKETS**

**NEW**

High visibility color: allows the user to be easily detected in work areas.



USCH51



Rear view

- 2" wide reflective bands on front and back.
- Made of 100% polyester.
- Front closure with metal snaps.
- Resistant to sun exposure and temperature changes.



ITEM	SIZE	COLOR	☞	AVAILABLE
USCH51	Medium	●	1	✓
USCH52	Large	●	1	✓
USCH53	Extra large	●	1	✓
USCH54	Double extra large	●	1	✓
USCH61	Medium	●	1	✓
USCH62	Large	●	1	✓
USCH63	Extra large	●	1	✓
USCH64	Double extra large	●	1	✓
USCH71	Medium	●	1	✓
USCH72	Large	●	1	✓
USCH73	Extra large	●	1	✓
USCH74	Double extra large	●	1	✓

**SUPERVISOR-TYPE SAFETY VESTS – OPEN STYLE WITH REFLECTIVE STRIP**



**KNITTED FABRIC**



**WATERPROOF POLYESTER FABRIC**

**REFLECTIVE BAND**

**NEW**

**4 MULTIFUNCTIONAL POCKETS**



137592

- Gray reflective strips on the front and back for high visibility.
- Adjustable with zipper closure.
- Weather-resistant, especially against water exposure.



ITEM	SIZE	COLOR	☞	AVAILABLE
137589	One size	●	1	On Request
137591	One size	●	1	On Request
137592	One size	●	1	On Request
137593	One size	●	1	On Request

**HIGH-VISIBILITY SAFETY VESTS WITH ZIPPER AND POCKETS**



**KNITTED FABRIC**



**6 POCKETS**

**NEW**



137496



137497



Rear view

- Reflective bands.
- Made of polyester mesh.
- Front zipper closure.



ITEM	SIZE	COLOR	☞	AVAILABLE
137496	One size	●	1	On Request
137497	One size	●	1	On Request

## SAFETY VESTS

### POLYESTER MESH SAFETY VEST



NEW



- Reflective bands.
- Made of polyester mesh.

ITEM	SIZE	COLOR	☐	AVAILABLE
137375	One size	●	5	On Request

### HIGH VISIBILITY VESTS WITH ZIPPER



NEW



137498

137499



- Reflective bands.
- Made of polyester fabric.
- Front closure.
- Reinforced stitching.

ITEM	SIZE	COLOR	☐	AVAILABLE
137498	One size	●	1	On Request
137499	One size	●	1	On Request

### POLYESTER MESH SAFETY VEST



NEW



Rear view



- Reflective bands.
- Made of polyester mesh.

ITEM	SIZE	COLOR	☐	AVAILABLE
137376	One size	●	5	On Request

### SAFETY VESTS WITH REFLECTIVE STRIPS



NEW



Vista trasera



- Reflective bands.
- Made of polyester fabric.

ITEM	SIZE	COLOR	☐	AVAILABLE
137377	One size	●	5	On Request
137378	One size	●	5	On Request

### POLYESTER MESH SAFETY VESTS



NEW



Vista trasera

137491



- Reflective bands
- Made of polyester fabric
- Elastic straps for a better fit.
- Front adjustment with double hook and loop.

ITEM	SIZE	COLOR	☐	AVAILABLE
137491	One size	●	1	✓
137492	One size	●	1	✓
137493	One size	●	1	✓
137494	One size	●	1	✓
137495	One size	●	1	✓

### SAFETY CLOTHING

#### DIELECTRIC APRON



- Ideal for use in the food industry, packing plants, washing and cleaning tasks, and handling organic waste.
- Elastic straps.
- Adjustable plastic buckle.

ITEM	DESCRIPTION	☐	AVAILABLE
137653	Industrial apron	1	✓

### BACK SUPPORT BELTS

#### RIGID BACK SUPPORT BELTS



- Helps correct the user's posture to prevent lower back injuries and provides greater comfort during long periods of standing or while performing loading and unloading tasks.

ITEM	SIZE	☐	AVAILABLE
USF04M	Medium	1	✓
USF04G	Large	1	✓
USF04X	Extra large	1	✓

#### RIGID BACK SUPPORT BELTS



NEW



137543

- Rigid foam inside the support.
- Comfortable abdominal area with hook-and-loop closure.
- Belt with adjustable plastic buckle.
- Provides comfort during long work shifts, whether standing or performing loading and unloading tasks.

ITEM	SIZE	☐	AVAILABLE
137543	Small	1	✓
137544	Medium	1	✓
137545	Large	1	✓
137546	Extra large	1	✓
137547	Double extra large	1	✓

**BACK SUPPORT BELTS**

**SHOULDER STRAP-BACK SUPPORT BELTS**



**HIGH VISIBILITY PLASTIC CLASP + THIRD BELT** **REINFORCED**

**HIGH VISIBILITY STRAP RINGS** **REINFORCED**

**HIGH VISIBILITY STRAP RINGS** **WITH MESH REINFORCED**

Reinforced elastics 3 belts  
**USF01C**  
**USF01M**  
**USF01G**  
**USF01X**  
**USF01EX**



**USF01C**

- Rigid binding to prevent product deformation.
- Adjustable elastic shoulder straps.
- Reinforced rigid belt.
- Elastic adjustment band.

Reinforced elastic  
**USF02C**  
**USF02M**  
**USF02G**  
**USF02X**  
**USF02EX**



**USF02C**

- Support belt with additional straps that provides support to the abdominal and lower back regions to prevent injuries caused by poor posture.

Mesh  
**USF03C**  
**USF03M**  
**USF03G**  
**USF03X**  
**USF03EX**



**USF03C**

**Reinforced elastic lumbar belt with 3 belts**

**Reinforced elastic lumbar belt**

**Mesh lumbar belt**

ITEM	USF01C	USF01M	USF01G	USF01X	USF01EX
SIZE	Small	Medium	Large	Extra Large	Double extra large
ELASTIC WIDTH	8"	8"	8"	8"	8"
⊞	1	1	1	1	1
AVAILABLE	✓	✓	✓	✓	✓

ITEM	USF02C	USF02M	USF02G	USF02X	USF02EX
SIZE	Small	Medium	Large	Extra Large	Double extra large
ELASTIC WIDTH	8"	8"	8"	8"	8"
⊞	1	1	1	1	1
AVAILABLE	✓	✓	✓	✓	✓

ITEM	USF03C	USF03M	USF03G	USF03X	USF03EX
SIZE	Small	Medium	Large	Extra Large	Double extra large
ELASTIC WIDTH	8"	8"	8"	8"	8"
⊞	1	1	1	1	1
AVAILABLE	✓	✓	✓	✓	On Request

**ELASTIC SUPPORT BELTS**



**3 PLASTIC RODS IN THE LOWER BACK** **HIGH VISIBILITY PLASTIC CLASP + THIRD BELT**

**3 PLASTIC RODS IN THE LOWER BACK**

**4 PLASTIC RODS IN THE LOWER BACK** **WITH MESH REINFORCED**

Reinforced  
**137538**  
**137539**  
**137540**  
**137541**  
**137542**



**137538**

- Elastic sacrolumbar support.
- Reinforced with elastic bands for a perfect fit.
- Provides comfort during long work shifts, whether standing or performing loading and unloading tasks.
- Ideal for preventing lower back injuries.
- High-visibility buckles.

Elastic  
**137500**  
**137501**  
**137502**  
**137503**  
**137508**



**137500**

- High-performance elastic sacrolumbar support to prevent lower back injuries.

Mesh  
**137504**  
**137505**  
**137506**  
**137507**  
**137509**



**137500**

- High-performance mesh sacrolumbar support developed to prevent lower back injuries.

**Reinforced**

**Elastic**

**Mesh**

ITEM	137538	137539	137540	137541	137542
SIZE	Small	Medium	Large	Extra large	Double extra large
⊞	1	1	1	1	1
AVAILABLE	✓	✓	✓	✓	✓

ITEM	137500	137501	137502	137503	137508
SIZE	Small	Medium	Large	Extra large	Double extra large
⊞	1	1	1	1	1
AVAILABLE	✓	✓	✓	✓	✓

ITEM	137504	137505	137506	137507	137509
SIZE	Small	Medium	Large	Extra large	Double extra large
⊞	1	1	1	1	1
AVAILABLE	✓	✓	✓	✓	✓

## RAINWEAR

### HEAT-REFLECTIVE SUIT



USIM41

- High-frequency sealing that prevents moisture penetration.
- Bib pants with adjustable straps for greater user comfort.
- Integrated hood with adjustable cord.
- 0.35 mm gauge.



ITEM	SIZE	☞	AVAILABLE
USIM41	Medium	1	✓
USIM42	Large	1	✓
USIM43	Extra Large	1	✓
USIM44	Double extra large	1	✓

### 2-PIECE HIGH-VISIBILITY WATERPROOF SUITS



USIM21

- High-frequency sealing that prevents moisture penetration.
- Bib pants with adjustable straps for greater user comfort.
- Integrated hood with adjustable cord.
- 0.35 mm gauge.



ITEM	SIZE	☞	AVAILABLE
USIM21	Medium	1	On Request
USIM22	Large	1	On Request
USIM23	Extra Large	1	On Request
USIM24	Double extra large	1	On Request

### 2-PIECE WATERPROOF SUITS WITH REFLECTIVE STRIPS



137615

- High-frequency sealed seams that prevent moisture penetration.
- 1.34 m length.
- Outer material 100% PVC, inner material 100% polyester.
- 0.35 mm thickness.



ITEM	SIZE	☞	AVAILABLE
137615	Small	1	On Request
137616	Medium	1	On Request
137617	Large	1	On Request
137618	Extra large	1	On Request

### 2-PIECE HIGH-VISIBILITY WATERPROOF SUITS



137533

- High-frequency sealed seams that prevent moisture penetration.
- Composition: 100% virgin polyvinyl chloride (PVC).
- 0.2 mm thickness.



ITEM	SIZE	☞	AVAILABLE
137533	Small	1	On Request
137534	Medium	1	On Request
137535	Large	1	On Request
137536	Extra large	1	On Request

### 2-PIECES RAIN SUIT



137525

- With outer pockets on the jacket.
- Zipper and snap button closure.
- High-frequency sealed seams.



ITEM	SIZE	☞	AVAILABLE
137525	Small	1	On Request
137526	Medium	1	On Request
137527	Large	1	On Request
137528	Extra Large	1	On Request

### HEAT-REFLECTIVE RAINCOAT



USIM31

- Made of 100% virgin PVC.
- Integrated hood with adjustable cord.
- 0.35 mm gauge for maximum protection.
- High-frequency sealing that prevents moisture penetration.



ITEM	SIZE	☞	AVAILABLE
USIM31	Medium	1	✓
USIM32	Large	1	✓
USIM33	Extra Large	1	✓
USIM34	Double extra large	1	✓

**RAINWEAR**

**WATERPROOF RAINCOATS WITH REFLECTIVE STRIPS**



137611

- Made of PVC.
- Integrated hood.
- 0.35 mm gauge.



ITEM	SIZE	☞	AVAILABLE
137611	Small	1	On Request
137612	Medium	1	On Request
137613	Large	1	On Request
137614	Extra large	1	On Request

**WATERPROOF PONCHO WITH THERMAL REFLECTIVE STRIP**



- Made of 100% virgin PVC.
- Integrated hood with adjustable cord.
- 0.35 mm gauge for maximum protection.
- High-frequency sealing that prevents moisture penetration.



ITEM	SIZE	☞	AVAILABLE
USIM50	One size	1	✓

**RAINCOATS**



137521

- Made of PVC.
- Integrated hood.
- 0.35 mm gauge.



ITEM	SIZE	☞	AVAILABLE
137521	Small	1	On Request
137522	Medium	1	On Request
137523	Large	1	On Request
137524	Extra Large	1	On Request

**WATERPROOF PONCHO WITH REFLECTIVE STRIP**



- Made of PVC.
- Integrated hood.
- 0.35 mm gauge.



ITEM	SIZE	☞	AVAILABLE
137619	One size	1	On Request

**HIGH VISIBILITY RAINCOAT**



USIM11

- Made of 100% virgin PVC.
- Integrated hood with adjustable cord.
- 0.35 mm gauge for maximum protection.
- High-frequency sealing that prevents moisture penetration.



ITEM	SIZE	☞	AVAILABLE
USIM11	Medium	1	On Request
USIM12	Large	1	On Request
USIM13	Extra Large	1	On Request
USIM14	Double extra large	1	On Request

**WATERPROOF PONCHO WITHOUT REFLECTIVE STRIP**



- Made of PVC.
- Integrated hood.
- 0.35 mm gauge.



ITEM	SIZE	☞	AVAILABLE
137520	One size	1	On Request

**HIGH-VISIBILITY WATERPROOF RAINCOATS**



137529

- Made of PVC.
- Integrated hood.
- 0.35 mm gauge.



ITEM	SIZE	☞	AVAILABLE
137529	Small	1	On Request
137530	Medium	1	On Request
137531	Large	1	On Request
137532	Extra large	1	On Request

**HIGH-VISIBILITY WATERPROOF PONCHO**



- Made of PVC.
- Integrated hood.
- 0.2 mm gauge.



ITEM	SIZE	☞	AVAILABLE
137537	One size	1	On Request

## KNEE PADS

### GEL KNEE PADS



- Gel knee pad with non-slip front.
- Allows prolonged positioning on flat surfaces that require stabilization.
- Segmented surface to prevent cracking
- With neoprene straps.



ITEM	DESCRIPTION	FILLED WITH GEL	☑	AVAILABLE
USK04	Stabilizer	•	1	✓



- Filled with gel and flexible rubber capsules.
- With neoprene straps for the thigh and lateral plastic inserts for better mobility.
- Articulated plasticized top to prevent the entry of debris.



ITEM	DESCRIPTION	FILLED WITH GEL	☑	AVAILABLE
USK05	Articulated	•	1	✓



### GEL KNEE PADS



NEW



RGPR

- Ergonomic design provides knee rest and comfort.
- Filled with gel for maximum comfort and protection.



ITEM	DESCRIPTION	FILLED WITH GEL	☑	AVAILABLE
RGPR	Reinforced PVC	•	1	On Request

### GEL KNEE PADS



RGP

- Ergonomic design provides support and comfort for the knee.
- Gel-filled for maximum comfort and protection.



ITEM	DESCRIPTION	FILLED WITH GEL	☑	AVAILABLE
RGP	PVC	•	1	On Request



RGC

- Ergonomic design provides support and comfort for the knee.
- Gel-filled for maximum comfort and protection.



ITEM	DESCRIPTION	FILLED WITH GEL	☑	AVAILABLE
RGC	Reinforced rubber	•	1	On Request



NEW

### EVA KNEE PADS



- Plastic capsule knee pad.
- With leather on the upper thigh to protect against welding slag.
- Rigid straps, elastic bands, and snap closure provide proper support.
- Leather thigh guard to prevent sparks from passing through.



ITEM	DESCRIPTION	FILLED WITH GEL	☑	AVAILABLE
USK02	To weld	-	1	✓

### EVA KNEE PADS



NEW



REVA

- Ergonomic design provides knee rest and comfort.
- Easy gliding on polished floors.



ITEM	DESCRIPTION	FILLED WITH GEL	☑	AVAILABLE
REVA	EVA	-	1	On Request

### RUBBER KNEE PADS



- Gel knee pad with flexible rubber body.
- Eva interior and gel area allow better adaptation to the knee's anatomy.
- Perfect fit providing enhanced protection.
- Easy and quick strap adjustment.



ITEM	DESCRIPTION	FILLED WITH GEL	☑	AVAILABLE
USK03	Rubber	•	1	✓



**KNEE PADS**

**RUBBER KNEE PADS**



**RGOR**

- Easy gliding on polished floors.
- Rubber helps prevent injuries during light activities.
- Ergonomic design provides rest and comfort for the knee.



ITEM	DESCRIPTION	AVAILABILITY
<b>RGOR</b>	Rigid rubber	1 On Request



**RGO**

- Easy gliding on polished floors.
- Rubber helps prevent injuries during light activities.
- Ergonomic design provides rest and comfort for the knee.



ITEM	DESCRIPTION	AVAILABILITY
<b>RGO</b>	Rubber	1 On Request



**RGOF**

- Easy gliding on polished floors.
- Rubber helps prevent injuries during light activities.
- Ergonomic design provides rest and comfort for the knee.



ITEM	DESCRIPTION	AVAILABILITY
<b>RGOF</b>	Flexible rubber	1 On Request



**SAFETY CLOTHING**

**LEATHER APRON**

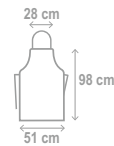

- 100% cowhide leather bib.
- Kevlar stitching resistant to abrasion.
- Ideal for blacksmithing and welding tasks.
- Provides enhanced protection when working with welding or sparks.
- Longer product lifespan.



ITEM	DESCRIPTION	AVAILABILITY
<b>USS1</b>	Leather apron	1 ✓

**LEATHER GLOVES**



- 100% cowhide leather bib.
- Kevlar stitching resistant to abrasion.
- Ideal for blacksmithing and welding tasks.
- Provides enhanced protection when working with welding or sparks.
- Longer product lifespan.



ITEM	DESCRIPTION	AVAILABILITY
<b>USS3</b>	Leather gloves	1 ✓

**LEATHER GAITERS**

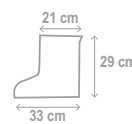

- 100% cowhide leather bib.
- Kevlar stitching resistant to abrasion.
- Ideal for blacksmithing and welding tasks.
- Provides enhanced protection when working with welding or sparks.
- Longer product lifespan.



ITEM	DESCRIPTION	AVAILABILITY
<b>USS2</b>	Leather gaiters	1 ✓

**COWHIDE LEATHER APRON**

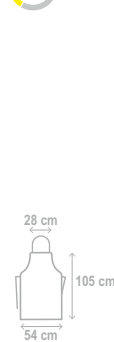

**124408**



**137652**



- 100% cowhide leather.
- Ideal for blacksmithing and welding work.



ITEM	DESCRIPTION	AVAILABILITY
<b>124408</b>	Long leather apron	1 ✓
<b>137652</b>	Leather apron	1 On Request

**COWHIDE LEATHER SLEEVES**

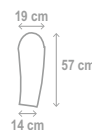

- 100% cowhide leather.
- Ideal for blacksmithing and welding work.



ITEM	DESCRIPTION	AVAILABILITY
<b>137651</b>	Cowhide leather sleeves	1 ✓

**COWHIDE LEATHER LEG COVER**

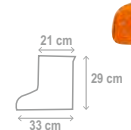

- 100% cowhide leather.
- Ideal for blacksmithing and welding work.



ITEM	DESCRIPTION	AVAILABILITY
<b>137650</b>	Cowhide leather leg cover	1 ✓

## MECHANIC GLOVES

### ANTI-VIBRATION MECHANIC GLOVES



1 1 - 1



- Synthetic leather gloves.
- Durable and comfortable synthetic leather.
- Elastic band with hook-and-loop adjustment.
- Stretch fabric for better breathability and ergonomics.
- Carbon fiber knuckle protection resistant to impacts.
- Gel-padded palm to reduce impacts and vibrations.

URREA



### MECHANIC GLOVES WITH CUT PROTECTION



1 3 - 1



- Durable and comfortable synthetic leather.
- Elastic band with hook-and-loop adjustment.
- Double layer of stretch fabric and spandex for enhanced comfort.
- Abrasion-resistant rubber (SBR) for knuckle protection.

URREA



ITEM	SIZE	🔗	AVAILABLE
USGVC	Small	1	On Request
USGVM	Medium	1	On Request
USGVG	Large	1	On Request
USGVX	Extra Large	1	On Request

ITEM	SIZE	🔗	AVAILABLE
USGCC	Small	1	On Request
USGCM	Medium	1	On Request
USGCG	Large	1	On Request
USGCX	Extra Large	1	On Request

### MECHANIC GLOVES ANTI-IMPACT



3 1 1 1



- Breathable and durable fabric.
- Elastic band with hook and loop adjustment.
- Stretch fabric for greater breathability and ergonomics.
- Index, middle, and thumb fingers touchscreen sensitive.
- Back of hand with TPU anti-impact protection.
- Padded palm, anti-abrasion, non-slip, and anti-vibration.

URREA



### GENERAL USE MECHANIC GLOVES



1 1 - 1



- Double layer of elastic fabric and neoprene for enhanced comfort.
- Elastic band with hook and loop adjustment.
- Stretch fabric for greater breathability and ergonomics.
- Double-layered palm with EVA padding.
- Non-slip tips on the middle, ring, and pinky fingers.

URREA



ITEM	SIZE	🔗	AVAILABLE
USGIM	Medium	1	On Request
USGIG	Large	1	On Request
USGIX	Extra Large	1	On Request

ITEM	SIZE	🔗	AVAILABLE
USGGM	Medium	1	On Request
USGGG	Large	1	On Request
USGGX	Extra Large	1	On Request

### GENERAL USE MECHANIC GLOVES FOR WOMAN



1 1 - 1



- Double layer of elastic fabric and neoprene for increased comfort.
- Elastic band with hook-and-loop adjustment.
- Stretch fabric for improved breathability and ergonomics.
- Double-layered palm with EVA padding.
- Non-slip tips on the middle, ring, and pinky fingers.

URREA



### IMPULSE CLIP STRIP ABRASION RESISTANT GLOVES



13 PIECES



ITEM	DESCRIPTION	🔗	AVAILABLE
TIMGC	Cut protection gloves clips strips	1	On Request

### IMPULSE CLIP STRIP GENERAL USE GLOVES



13 PIECES



ITEM	DESCRIPTION	🔗	AVAILABLE
TIMGG	All-purpose gloves clips strips	1	On Request

**COWHIDE WORKING GLOVES**

**COW LEATHER WORKING GLOVES**



- Made from durable leather with a maximum thickness of up to 1.5 mm.
- Sewn with Kevlar thread in the thumb area for increased strength.
- Quick-adjust hook-and-loop strap for optimal performance.
- Use: mechanics, assembly, carpentry, construction industry, equipment and machinery operation, manufacturing, handling of hand tools.



ITEM	SIZE	🔒	AVAILABLE
USGLA	One Size	1	✓

**COWHIDE WELDING GLOVES**



- Made from durable cowhide leather with a maximum thickness of up to 1.5 mm.
- Sewn with Kevlar thread in the thumb area for added strength.
- 1 mm leather reinforcement on the palm and thumb area for increased durability.
- Long cuff providing greater protection for the user.

ITEM	SIZE	🔒	AVAILABLE
USGLS	One Size	1	On Request

**OPERATOR COWHIDE GLOVES**



- Glove made from durable cowhide leather, which increases the product's lifespan.
- 1 mm leather reinforcement on the palm and thumb area for greater durability.
- Sewn with Kevlar thread in the thumb area for increased strength and safety.
- Use: mechanics, assembly, carpentry, construction industry, equipment and machinery operation, manufacturing, handling of hand tools.

ITEM	SIZE	🔒	AVAILABLE
USGLO	One Size	1	On Request

**SHEEPSKIN REINFORCED GLOVE**



- Made from sheepskin.
- Cowhide leather reinforcement on the palm for greater durability.
- Elastic wrist for a better fit.



ITEM	SIZE	🔒	AVAILABLE
137383	One Size	1	✓

**SHEEPSKIN AND COWHIDE LEATHER GLOVES**



- Made of sheepskin with cowhide reinforcements.
- Elastic wrist for a better fit.



ITEM	SIZE	🔒	AVAILABLE
137382	One Size	1	✓

**LAMBSKIN LEATHER GLOVES**



- Made of sheepskin.
- Elastic wrist for a better fit.



ITEM	SIZE	🔒	AVAILABLE
137380	One size	1	On Request

**COWHIDE WORKING GLOVES**



- Made from durable cowhide leather.
- Quick-adjust strap for improved performance.
- Lightweight design allowing greater mobility.



ITEM	SIZE	🔒	AVAILABLE
137412	One size	1	✓

**COWHIDE LEATHER WELDER GLOVES**



- Made from durable cowhide leather.
- Provides high protection against sparks and slag during welding and metalworking.



ITEM	SIZE	🔒	AVAILABLE
137387	One Size	1	✓

**COWHIDE OPERATOR GLOVES**



- Made from durable cowhide leather.
- Provides high protection against sparks and slag during welding and metalworking.



ITEM	SIZE	🔒	AVAILABLE
137413	One size	1	✓

## COWHIDE WORKING GLOVES

### LEATHER WORK GLOVES



3 1 3 2



- Made of durable cowhide leather.
- Short quick-release cuff.
- Additional protection on palm and fingers.
- For handling abrasive materials.



ITEM	SIZE	☐	AVAILABLE
GBLO	One size	1	On Request

### PALM LEATHER GLOVES



1 1 1 1



- Made of durable cowhide leather on the palm.
- Short cotton cuff for a better fit.



ITEM	SIZE	☐	AVAILABLE
137390	One size	1	✓

### WELDING LEATHER GLOVES



3 2 3 2



- Made of durable cowhide leather.
- Protection against sparks and metal splinters.



ITEM	FIST TYPE	☐	AVAILABLE
137386	Long	1	✓

### COWHIDE LEATHER GLOVES



3 2 2 2



- Made of durable cowhide leather.
- Protection against sparks and metal splinters.



ITEM	FIST TYPE	☐	AVAILABLE
137385	Short	1	✓

### COWHIDE LEATHER GLOVES



3 2 3 2



3 2 3 2



- Made of durable cowhide leather.
- Protection against sparks and metal splinters.



ITEM	SIZE	☐	AVAILABLE
GCAL	One Size	1	On Request

- Made of durable cowhide leather.
- Protection against sparks and metal splinters.



ITEM	SIZE	☐	AVAILABLE
GCAE	One Size	1	On Request

### REINFORCED COWHIDE LEATHER AND CANVAS GLOVES



3 2 2 2



- Made with cowhide leather and 100% cotton canvas reinforcement.



ITEM	SIZE	☐	AVAILABLE
137389	One size	6	On Request

### COWHIDE LEATHER AND CANVAS GLOVES



3 2 2 2



- Made with cowhide leather and 100% cotton canvas reinforcement.



ITEM	SIZE	☐	AVAILABLE
137388	One size	6	On Request

**GLOVE WITH COATING**

**NITRILE COATED CUT RESISTANT GLOVES**

**INDUSTRIAL DUTY** **CUT-RESISTANT**  
3 4 4 4



- Made with cut-resistant HPPE fiber, Supraneema type.
- The knitted, elastic wrist helps prevent dirt and debris from entering the glove.
- For use in auto parts manufacturing, plastic injection molding, handling knives, sharp parts, assembly, etc.



ITEM	FINAL COLOR	SIZE	☞	AVAILABLE
USGDC	Blue	Small	1	On Request
USGDM	Red	Medium	1	On Request
USGDG	Yellow	Large	1	On Request
USGDY	Orange	Extra Large	1	On Request

**NITRILE COATED COTTON GLOVES**

**GENERAL USE**  
4 1 2 1



- Made of cotton.
- Elastic wrist helps prevent dirt from entering the glove.
- Ideal for handling oils and greases, recycling industries, machinery maintenance, and construction.



ITEM	SIZE	☞	AVAILABLE
GALN	Medium	6	On Request

**NYLON GLOVES WITH NITRILE COATING**

**PROFESSIONAL USE**  
4 1 2 1



GNNC

- Made with medium-gauge nylon fiber.
- The knitted, elastic wrist helps prevent dirt and debris from entering the glove.
- Suitable for handling light oils, providing good grip and excellent abrasion resistance.



ITEM	SIZE	☞	AVAILABLE
GNNC	Small	6	On Request
GNNM	Medium	6	On Request
GNNG	Large	6	On Request

**FOAMED NITRILE COATED NYLON GLOVES**

**INDUSTRIAL DUTY**  
4 1 2 1



- Made with high-gauge nylon fiber.
- The knitted, elastic wrist helps prevent dirt and debris from entering the glove.
- Its ultra-thin, seamless design ensures maximum comfort and high hand dexterity.
- Suitable for handling light oils, providing good grip and excellent abrasion resistance.
- Improved grip on wet or oily surfaces.



ITEM	SIZE	☞	AVAILABLE
USGEC	Small	1	On Request
USGEM	Medium	1	On Request
USGEG	Large	1	On Request
USGEX	Extra Large	1	On Request

**COTTON GLOVES WITH FULL NITRILE COATING**

**PROFESSIONAL USE**  
4 1 1 1



NEW



- Made of cotton.
- Ideal for handling oils and greases, recycling industries, machinery maintenance, and construction.



ITEM	SIZE	☞	AVAILABLE
GALNS	One Size	1	On Request

**IMPULSE STRAP WITH NYLON GLOVES WITH NITRILE COATING**

**PROFESSIONAL USE**  
4 1 2 1



26 PIECES

NEW



ITEM	DESCRIPTION	☞	AVAILABLE
126445	24 Nylon Gloves plus 2 Impulse Straps	1	✓

## GLOVE WITH COATING

### POLYURETHANE COATED CUT RESISTANT GLOVES



4 3 4 2

- Made with cut-resistant HPPE fiber, supraneema type.
- The knitted, elastic wrist helps prevent dirt and debris from entering the glove.
- Ideal for handling abrasive and sharp objects in wet, dry, or oily conditions where excellent dexterity, sensitivity, and grip are required.
- Leaves no residue, making it ideal for electronics and fine assembly.



USGHC



ITEM	SIZE	AVAILABILITY
USGHC	Small	1 On Request
USGHM	Medium	1 On Request
USGHG	Large	1 On Request
USGHX	Extra Large	1 On Request

### LATEX COATED COTTON GLOVES



2 1 2 1

- Made of cotton.
- Elastic wrist helps prevent dirt from entering the glove.



ITEM	SIZE	AVAILABILITY
GALA	Large	6 On Request

### NYLON GLOVES WITH POLYURETHANE COATING



3 1 2 1

- Made with high-gauge nylon fiber.
- The knitted, elastic wrist helps prevent dirt and debris from entering the glove.
- Ideal for handling abrasive and sharp objects in wet, dry, or oily conditions where excellent dexterity, sensitivity, and grip are required.



GNPM



NEW

ITEM	SIZE	AVAILABILITY
GNPC	Small	6 On Request
GNPM	Medium	6 On Request
GNPG	Large	6 On Request

### GARDENING NYLON GLOVES



4 1 2 1

- Made with medium-gauge nylon fiber.
- Suitable for any gardening work at home.
- Water-repellent, non-slip palm.
- High flexibility and dexterity.



NEW



ITEM	SIZE	AVAILABILITY
GNIJ	Medium	1 On Request

## LATEX GLOVES

### LATEX GLOVES FOR INDUSTRIAL USE



3 1 2 1

- 100% natural latex.
- Length: 45 cm.
- Resistant to acids and inert to alkalis.
- Ideal for industrial, gardening, and construction work.

ITEM	SIZE	AVAILABILITY
137397	Small	1 ✓
137398	Medium	1 ✓
137399	Large	1 ✓

### PAINTER GLOVES



3 1 2 1

NEW

- 100% natural latex.
- 0.70 mm thickness.
- Cotton inner lining.
- Non-slip texture.
- Resistant to chemicals, solvents, and microorganisms.

ITEM	SIZE	AVAILABILITY
137406	Medium	1 On Request
GLPM	Medium	1 On Request
GLPG	Large	1 On Request

### LATEX CLEANING GLOVES



3 1 2 1

NEW

- 100% natural latex.
- 0.47 mm thickness.
- No cotton inner lining.
- Ideal for general cleaning tasks and handling detergents.

ITEM	SIZE	AVAILABILITY
GLM	Medium	1 On Request
GLG	Large	1 On Request

### LATEX GLOVES WITH INNER LINING



3 1 2 1

NEW

- 100% natural latex.
- Cotton inner lining.
- 0.35 mm thickness.
- Non-slip texture.
- Ideal for household tasks, bathrooms, kitchens, and general cleaning.

ITEM	SIZE	AVAILABILITY
GLFC	Small	1 On Request
GLFM	Medium	1 On Request
GLFG	Large	1 On Request

**SAFETY BOOTS**

**SPORT DIELECTRIC SAFETY BOOTS**

**HEAVY DUTY** **SPORT SAFETY FOOTWEAR** **SLIP-RESISTANT SOLE**

**DIELECTRIC FOOTWEAR RESISTANCE UP TO 18,000 V** **PADDED COLLAR**

**BOVINE LEATHER 100%** **POLYAMIDE POLYURETHANE** **LIGHT**

- Quick-release plastic hooks with metal reinforcements coated with epoxy, making them dielectric.
- Lacing made of polyester with a cotton core.
- Sole made of high-density polyurethane, highly resistant to acids, lubricants, and fuels.
- Standard: NOM-113-STPS-2009.



ITEM	SIZE		⊞	AVAILABLE
	CM	USA		
USZD5	25	7	1	On Request
USZD6	26	8	1	On Request
USZD65	26.5	8.5	1	On Request
USZD7	27	9	1	On Request
USZD75	27.5	9.5	1	On Request

ITEM	SIZE		⊞	AVAILABLE
	CM	USA		
USZD8	28	10	1	✓
USZD85	28.5	10.5	1	✓
USZD9	29	11	1	✓
USZD10	30	12	1	✓

**TOP COMFORT DIELECTRIC SAFETY BOOTS**

**HEAVY DUTY** **TOP COMFORT SAFETY FOOTWEAR** **SLIP-RESISTANT SOLE**

**DIELECTRIC FOOTWEAR RESISTANCE UP TO 14,000 V** **PADDED COLLAR**

**BOVINE LEATHER 100%** **POLYAMIDE POLYURETHANE**

- Quick-release plastic hooks with metal reinforcements coated with epoxy, making them dielectric.
- Lacing made of polyester with a cotton core.
- Sole made of high-density polyurethane, highly resistant to acids, lubricants, and fuels.
- Standard: NOM-113-STPS-2009.



ITEM	SIZE		⊞	AVAILABLE
	CM	USA		
USZC5	25	7	1	✓
USZC6	26	8	1	✓
USZC65	26.5	8.5	1	On Request
USZC7	27	9	1	✓
USZC75	27.5	9.5	1	On Request
USZC8	28	10	1	✓

ITEM	SIZE		⊞	AVAILABLE
	CM	USA		
USZC85	28.5	10.5	1	✓
USZC9	29	11	1	✓
USZC10	30	12	1	On Request
USZC11	31	13	1	On Request
USZC12	32	14	1	✓

**PREMIUM DIELECTRIC SAFETY BOOTS**

**INDUSTRIAL DUTY** **PREMIUM SAFETY FOOTWEAR**

**DIELECTRIC FOOTWEAR RESISTANCE UP TO 14,000 V** **PADDED COLLAR**

**BOVINE LEATHER 100%** **POLYAMIDE PVC WATERPROOF**

- Lacing made of polyester with a cotton core.
- Sole made of high-density polyurethane, highly resistant to acids, lubricants, and fuels.
- Standard: NOM-113-STPS-2009.



ITEM	SIZE		⊞	AVAILABLE
	CM	USA		
USZS5	25	7	1	✓
USZS6	26	8	1	✓
USZS65	26.5	8.5	1	✓
USZS7	27	9	1	✓
USZS75	27.5	9.5	1	✓
USZS8	28	10	1	✓

ITEM	SIZE		⊞	AVAILABLE
	CM	USA		
USZS85	28.5	10.5	1	✓
USZS9	29	11	1	✓
USZS10	30	12	1	✓
USZS11	31	13	1	✓

**ELECTRICAL SAFETY BOOTS, CASUAL TYPE**

**INDUSTRIAL DUTY** **CASUAL SAFETY FOOTWEAR**

**DIELECTRIC FOOTWEAR RESISTANCE UP TO 14,000 V** **PADDED COLLAR**

**BOVINE LEATHER 100%** **STEEL PVC LIGHT**

- Lacing made of polyester with a cotton core.
- Sole made of high-density polyurethane, highly resistant to acids, lubricants, and fuels.
- Standard: NOM-113-STPS-2009.



ITEM	SIZE		⊞	AVAILABLE
	CM	USA		
USZA5	25	7	1	✓
USZA6	26	8	1	✓
USZA65	26.5	8.5	1	✓
USZA7	27	9	1	✓
USZA75	27.5	9.5	1	✓

ITEM	SIZE		⊞	AVAILABLE
	CM	USA		
USZA8	28	10	1	✓
USZA85	28.5	10.5	1	✓
USZA9	29	11	1	✓
USZA10	30	12	1	✓

**DIELECTRIC SAFETY BOOTS, ROPER TYPE**

**INDUSTRIAL DUTY** **ROPER SAFETY FOOTWEAR**

**SLIP-RESISTANT SOLE**

**DIELECTRIC FOOTWEAR RESISTANCE UP TO 14,000 V**

**BOVINE LEATHER 100%** **STEEL POLYURETHANE EVA**

- Sole made of elastomer resistant to fuels, lubricants, and acids: perfect for any industrial work.
- Standard: NOM-113-STPS-2009.



ITEM	SIZE		⊞	AVAILABLE
	CM	USA		
USZP4	24	6	1	✓
USZP5	25	7	1	✓
USZP6	26	8	1	✓
USZP65	26.5	8.5	1	✓
USZP7	27	9	1	✓

ITEM	SIZE		⊞	AVAILABLE
	CM	USA		
USZP75	27.5	9.5	1	✓
USZP9	29	11	1	✓

**ULTRA-LIGHT DIELECTRIC SAFETY BOOTS**

**INDUSTRIAL DUTY** **ULTRA LIGHT SAFETY FOOTWEAR** **BIMATERIAL SOLE**

**DIELECTRIC FOOTWEAR RESISTANCE UP TO 14,000 V** **SLIP-RESISTANT SOLE**

**PADDED COLLAR** **BOVINE LEATHER 100%** **POLYAMIDE POLYURETHANE**

- Lacing made of polyester with a cotton core.
- Sole made of high-density polyurethane, highly resistant to acids, lubricants, and fuels.
- Standard: NOM-113-STPS-2009.



ITEM	SIZE		⊞	AVAILABLE
	CM	USA		
USZL5	25	7	1	✓
USZL6	26	8	1	✓
USZL65	26.5	8.5	1	✓
USZL7	27	9	1	✓
USZL75	27.5	9.5	1	✓

ITEM	SIZE		⊞	AVAILABLE
	CM	USA		
USZL8	28	10	1	✓
USZL85	28.5	10.5	1	✓
USZL9	29	11	1	✓
USZL10	30	12	1	✓

**SAFETY BOOTS**

**DIELECTRIC SAFETY BOOTS – PINK LINE**

**INDUSTRIAL DUTY**
**WOMAN**
**SLIP-RESISTANT SOLE**

**DIELECTRIC FOOTWEAR RESISTANCE UP TO 14,000 V**
**PADDED COLLAR**
**BOVINE LEATHER 100%**
**POLYAMIDE POLYURETHANE**
**LIGHT**

- Laces made of polyester with a cotton core.
- Sole made of high-density polyurethane, highly resistant to acids, lubricants, and fuels.
- Standard: NOM-113-STPS-2009.

ITEM	SIZE		☞	AVAILABLE
	CM	USA		
USZM2	22	5	1	✓
USZM3	23	6	1	✓
USZM4	24	7	1	✓

ITEM	SIZE		☞	AVAILABLE
	CM	USA		
USZM5	25	8	1	✓
USZM6	26	9	1	✓
USZM7	27	10	1	✓

**DIELECTRIC SAFETY BOOTS**

**PROFESSIONAL USE**
**DIELECTRIC SAFETY FOOTWEAR**
**SLIP-RESISTANT SOLE**

**BOVINE LEATHER 100%**
**PADDED COLLAR**
**POLYAMIDE TOE CAP**
**ANATOMIC INSOLE**

- Sole made of high-density polyurethane, highly resistant to lubricants and fuels.
- Standard: NOM-113-STPS-2009.

ITEM	SIZE		☞	AVAILABLE
	CM	USA		
137481	24	6	1	✓
137482	25	7	1	✓
137483	26	8	1	✓
137484	26.5	8.5	1	✓
137485	27	9	1	✓

ITEM	SIZE		☞	AVAILABLE
	CM	USA		
137486	27.5	9.5	1	✓
137487	28	10	1	✓
137488	28.5	10.5	1	✓
137489	29	11	1	✓
137490	30	12	1	✓

**HIGH-TEMPERATURE SAFETY BOOTS**

**HEAVY DUTY**
**HIGH TEMPERATURE RESISTANT SAFETY FOOTWEAR**
**PADDED COLLAR**

**BOVINE LEATHER 100%**
**POLYAMIDE ACRYLONITRILE RUBBER**
**EVA**

- Elastomer sole resistant to fuels, lubricants, and acids: perfect for any industrial work.
- Diamond-pattern natural leather upper.
- Standard: NOM-113-STPS-2009.

ITEM	SIZE		☞	AVAILABLE
	CM	USA		
USZH5	25	7	1	✓
USZH6	26	8	1	✓
USZAH65	26.5	8.5	1	✓
USZH7	27	9	1	✓
USZH75	27.5	9.5	1	✓

ITEM	SIZE		☞	AVAILABLE
	CM	USA		
USZH8	28	10	1	✓
USZH85	28.5	10.5	1	✓
USZH9	29	11	1	✓
USZH10	30	12	1	✓

**TACTICAL SAFETY BOOTS**

**INDUSTRIAL DUTY**
**TACTIC SAFETY FOOTWEAR**
**PADDED COLLAR**

**BOVINE LEATHER 100%**
**TERMOPLASTIC RESIN POLYURETHANE ANATOMIC**

- Side zipper for easy boot on and off.
- Thermofomed thermoplastic toe cap that protects the foot from light impacts (not from free-falling objects).
- Standard: NOM-113-STPS-2009.

ITEM	SIZE		☞	AVAILABLE
	CM	USA		
USZT5	25	7	1	✓
USZT6	26	8	1	✓
USZT65	26.5	8.5	1	✓
USZT7	27	9	1	✓
USZT75	27.5	9.5	1	✓

ITEM	SIZE		☞	AVAILABLE
	CM	USA		
USZT8	28	10	1	✓
USZT85	28.5	10.5	1	✓
USZT9	29	11	1	✓
USZT10	30	12	1	✓

SAFETY EQUIPMENT

**SAFETY BOOTS**

**PROFESSIONAL USE**
**BLACK SAFETY FOOTWEAR**

**SLIP-RESISTANT SOLE**
**PADDED COLLAR**
**NATURAL LEATHER**
**POLYAMIDE TOE CAP**
**ANATOMIC INSOLE**

- Reinforced design for greater durability.
- Standard: NOM-113-STPS-2009.

ITEM	SIZE		☞	AVAILABLE
	CM	USA		
137510	24	6	1	✓
137511	25	7	1	✓
137512	26	8	1	✓
137513	26.5	8.5	1	✓
137514	27	9	1	✓

ITEM	SIZE		☞	AVAILABLE
	CM	USA		
137515	27.5	9.5	1	✓
137516	28	10	1	✓
137517	28.5	10.5	1	✓
137518	29	11	1	✓
137519	30	12	1	✓

**SAFETY BOOTS CLASSIC**

**PROFESSIONAL USE**
**CLASSIC SAFETY FOOTWEAR**

**SLIP-RESISTANT SOLE**
**PADDED COLLAR**
**NATURAL LEATHER**
**POLYAMIDE TOE CAP**
**FUEL PROOF SOLE OIL PROOF SOLE**

- Standard: NOM.113-STPS-2009.

ITEM	SIZE		☞	AVAILABLE
	CM	USA		
137577	22	4	1	✓
137578	23	5	1	✓
137579	24	6	1	✓
137580	25	7	1	✓
137581	26	8	1	✓
137582	26.5	8.5	1	✓

ITEM	SIZE		☞	AVAILABLE
	CM	USA		
137583	27	9	1	✓
137584	27.5	9.5	1	✓
137585	28	10	1	✓
137586	28.5	10.5	1	✓
137587	29	11	1	✓
137588	30	12	1	✓



**SAFETY BOOTS**

**PVC BOOTS WITH TOE CAP**

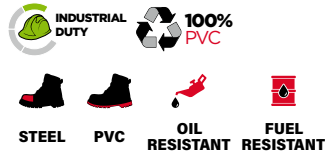

- Made of 100% PVC with internal cotton reinforcement.
- High resistance to abrasion, bending, and tearing.
- Resistant to water, detergents, mud, sludge, steam, etc.
- Elastomer sole resistant to fuels, lubricants, and acids: perfect for any industrial job.

ITEM	SIZE		USA	☑	AVAILABLE
	CM	USA			
USBIC4	24	6	1	✓	
USBIC5	25	7	1	✓	
USBIC6	26	8	1	✓	
USBIC7	27	9	1	On Request	

ITEM	SIZE		USA	☑	AVAILABLE
	CM	USA			
USBIC8	28	10	1	✓	
USBIC9	29	11	1	✓	
USBIC10	30	12	1	✓	

**INDUSTRIAL PVC BOOTS**



- Made of 100% PVC with internal cotton reinforcement.
- High resistance to abrasion, bending, and tearing.
- Resistant to water, detergents, mud, sludge, steam, etc.
- Resistant to gasoline, oils, solvents, and diluted corrosive acids (sulfuric, acetic, nitric, etc.).
- Boot height: 38 cm.

ITEM	SIZE		USA	☑	AVAILABLE
	CM	USA			
137550	24	6	1	✓	
137551	25	7	1	✓	
137552	26	8	1	✓	
137553	27	9	1	✓	

ITEM	SIZE		USA	☑	AVAILABLE
	CM	USA			
137554	28	10	1	✓	
137555	29	11	1	✓	
137556	30	12	1	✓	

**SANITARY PVC BOOTS**



- Made of 100% PVC with internal cotton reinforcement.
- Resistant to water, detergents, mud, sludge, steam, etc.
- Resistant to corrosive acids.
- Boot height: 38 cm.

ITEM	SIZE		USA	☑	AVAILABLE
	CM	USA			
137557	24	6	1	✓	
137558	25	7	1	✓	
137559	26	8	1	✓	
137560	27	9	1	✓	

ITEM	SIZE		USA	☑	AVAILABLE
	CM	USA			
137561	28	10	1	✓	
137562	29	11	1	✓	
137563	30	12	1	✓	

**GARDENING PVC BOOTS**



- Made of 100% PVC with internal cotton reinforcement.
- Resistant to water, detergents, mud, sludge, steam, etc.
- Boot height: 38 cm.

ITEM	SIZE		USA	☑	AVAILABLE
	CM	USA			
137564	24	6	1	✓	
137565	25	7	1	✓	
137566	26	8	1	✓	
137567	27	9	1	✓	

ITEM	SIZE		USA	☑	AVAILABLE
	CM	USA			
137568	28	10	1	✓	
137569	29	11	1	✓	
137570	30	12	1	✓	

**ANTI-SLIP TAPES**

**ANTI-SLIP TAPES**



137367



137368

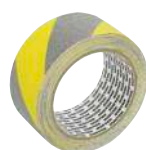

137369

- Width: 48 mm.
- High-adhesion base.
- For use on floors, stairs, ramps, and emergency exits.

ITEM	LENGTH	COLOR	☑	AVAILABLE
137367	16.4'	●	6	✓
137368	16.4'	○	6	On Request
137369	16.4'	● ●	6	✓

**MARKING TAPE**

**MARKING TAPE**



138060



138061



138062

- Thickness: 0.105 mm.
- Width: 2" (48 mm).
- Acrylic adhesive.

ITEM	LENGTH	COLOR	☑	AVAILABLE
138061	59'	○ ●	6	On Request
138062	59'	○ ●	6	On Request
138060	59'	● ●	6	On Request

## CONES

### FOLDABLE SAFETY CONE WITH REFLECTIVE STRIP



NEW

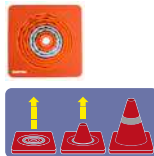

- Water-resistant.
- For daytime and nighttime use.
- Foldable design for easy transport and storage.
- Made of PVC to extend its service life.



ITEM	HEIGHT	WEIGHT	BASE SIZE	⊞	AVAILABLE
137605	17.7"	0.56 kg	9.64" x 9.64"	1	On Request

### SAFETY CONES



NEW



137463

- Made of durable PVC.
- High visibility.
- Heavier than the competition.
- For marking specific areas such as roadways, parking lots, walking and running areas, etc.

BULK

ITEM	HEIGHT	WEIGHT	BASE SIZE	⊞	AVAILABLE
137463	17.7"	2.86 lb	10.43" x 10.43"	1	On Request
137464	27.55"	7 lb	13.7" x 13.7"	1	On Request
137601	35.43"	9.25 lb	14.17" x 14.17"	1	On Request

### TRAFFIC CONES



PVC reflective tape

137461

- Made of durable PVC.
- High visibility.
- Heavier than the competition.
- For marking specific areas such as roadways, parking lots, walking and running areas, etc.

BULK

ITEM	HEIGHT	WEIGHT	DIMENSIONS	⊞	AVAILABLE
137461	17.7"	2.86 lb	10.43" x 10.43"	1	On Request
137462	27.55"	7 lb	13.7" x 13.7"	1	On Request
137600	35.43"	9.25 lb	14.17" x 14.17"	1	On Request

### PARKING STOP

#### PARKING STOP



- Made of high-strength rubber.
- Reflective triangles for proper nighttime visibility.
- Does not break, crumble, crack, or rot.



ITEM	DIMENSIONS	⊞	AVAILABLE
137459	21.2" x 6.2" x 4.3"	1	✓

## REFLECTIVE TRIANGLES

### FOLDABLE EMERGENCY REFLECTIVE TRIANGLE



NEW



- Made of high-strength polystyrene.
- Multi-angle design with 8 reflectors to increase triangle visibility.
- High visibility.
- Primarily used for emergency signaling on vehicles.



ITEM	HEIGHT	PIECES	⊞	AVAILABLE
TRF10A	10" assembleable	1	1	On Request

### EMERGENCY REFLECTIVE TRIANGLES



TRF101

- Made of durable PVC.
- Base made of polystyrene filled with sand to ensure triangle stability.
- High visibility.
- Primarily used for emergency signaling on vehicles.
- Also used to mark pedestrian areas, parking lots, etc.



ITEM	SIZE	PACKAGING	PIECES	⊞	AVAILABLE
TRF101	11-1/2"	Plastic Box	1	1	On Request
TRF171	17"	Textile Case	1	1	On Request
TRF172	17"	Textile Case	2	1	On Request



CLASS

TYPE

PAGE

BRAND



Electric material

Cable staples

634



Flexible hoses

634



[usa.urrea.com](http://usa.urrea.com)

We are constantly improving our products, that is why the information, characteristics and availability of them can change without prior notice.

## WIRING AND CHANNELING



### CABLE STAPLES CHARACTERISTICS:

- Fluted nail with flat top, special for concrete.
- 100% high density polyethylene with UV protection for environment.
- Internal space that respect the wire's impedance and give a better clamping.

### NAIL-IN CABLE CLIP



- Concrete nails with durable polyethylene clip.
- Convenient 20-piece pack.



ITEM	NAIL LENGTH	COLOR		AVAILABLE
GRAC5	13/64" (5 mm)	○	1	On Request
GRAC6	15/64" (6 mm)	○	1	On Request
GRAC8	5/16" (8 mm)	○	1	On Request
GRAC10	25/64" (10 mm)	○	1	On Request
GRAC12	15/32" (12 mm)	○	1	On Request
GRAC16	5/8" (16 mm)	○	1	On Request

### CORRUGATED FLEXIBLE CONDUIT



- Made of high-density polyethylene (HDPE).
- Electrical insulation resistance greater than 100 MΩ.
- High resistance to natural elements (water, soil, UV rays).
- Reinforced metal guide for easier cable installation.
- Maximum flexibility to prevent tube collapse.
- Distance indicator ring every meter.



ITEM	DIAMETER	LENGHT	APPLICATION	WITH GUIDE		AVAILABLE
136852	1/2" (12.7 mm)	328.08 ft (100 m)	Residential	✓	1	✓
136853	3/4" (19.05 mm)	164.04 ft (50 m)	Residential	✓	1	✓
136854	1" (25.4 mm)	164.04 ft (50 m)	Residential	✓	1	✓
136850	1/2" (12.7 mm)	328.08 ft (100 m)	Residential	✗	1	✓
136851	3/4" (19.05 mm)	164.04 ft (50 m)	Residential	✗	1	✓
136855	1" (25.4 mm)	164.04 ft (50 m)	Residential	✗	1	On Request

**PROFESSIONAL FLEXIBILITY**



usa.urrea.com

CORRUGATED FLEXIBLE CONDUIT



CLASS	TYPE	PAGE	BRAND	
			URREA	SURTEK
Miscellaneous tools	Chain leash	636		•
	Dog training chain	636		•
	Hose clamps	636		•
	Plastic cable ties	636		•
	Aluminum foil tape	637	•	
	Double-sided tape	637		•
	Duct tape	637	•	•
	Acrylic tape	638		•
	Dispenser	638	•	
	Hot melt adhesive tape	638	•	•
	Electrical tape	639	•	•
	Masking tape	639	•	•
	Silicone tape	639	•	
	Stapler	640	•	•
	Thread seal tape	640	•	•
	Brackets	641		•
	Ladders	641		•
	Plotting equipment	641		•
	Sandpaper	642		•
	Shade net roll	643		•
	Tarps	643		•
	Mosquito screen mesh	644		•
	Riveters	645	•	•
	Drywall stilts	646		•
	Rivets	646		•

[usa.urrea.com](http://usa.urrea.com)

We are constantly improving our products, that is why the information, characteristics and availability of them can change without prior notice.

## STAINLESS STEEL STRAPS

### ENDLESS STRAPS



- Made of stainless steel.
- With tempered steel screw.
- Standard slot screws with hex head.
- Suitable for industrial, automotive, and home use.



NEW

PRICE PER BAG



ITEM	MIN	MAX	WIDTH	PIECES PER BAG	☞	AVAILABLE
137724	1/2"	3/4"	1/2"	10 pieces	50	On Request
137726	9/16"	1 1/16"	1/2"	10 pieces	50	On Request
137702	5/8"	1"	1/2"	10 pieces	50	On Request
137703	7/16"	1-1/16"	1/2"	10 pieces	50	On Request
137704	5/8"	1-1/4"	1/2"	10 pieces	50	On Request
137705	3/4"	1-1/2"	1/2"	10 pieces	50	On Request
137706	3/4"	1-3/4"	1/2"	10 pieces	50	On Request
137707	1-1/4"	2"	1/2"	10 pieces	50	On Request
137708	1-1/2"	2-1/4"	1/2"	10 pieces	50	On Request
137709	1-9/16"	2-1/2"	1/2"	5 pieces	50	On Request
137710	1-13/16"	2-3/4"	1/2"	5 pieces	25	On Request
137711	2-1/4"	3"	1/2"	5 pieces	25	On Request
137712	2-5/8"	3-1/4"	1/2"	5 pieces	25	On Request

ITEM	MIN	MAX	WIDTH	PIECES PER BAG	☞	AVAILABLE
137713	2-9/16"	3-1/2"	1/2"	5 pieces	25	On Request
137714	2-13/16"	3-3/4"	1/2"	5 pieces	25	On Request
137715	3-1/16"	4"	1/2"	5 pieces	25	On Request
137716	3-5/16"	4-1/4"	1/2"	5 pieces	20	On Request
137717	3-9/16"	4-1/2"	1/2"	5 pieces	20	On Request
137718	4-1/8"	5"	1/2"	5 pieces	20	On Request
137720	5-1/8"	6"	1/2"	5 pieces	20	On Request
137722	6-1/8"	7"	1/2"	5 pieces	10	On Request

### Mini drive clamps

ITEM	MIN	MAX	WIDTH	PIECES PER BAG	☞	AVAILABLE
137728	1/4"	5/8"	5/16"	20 pieces	200	On Request
137700	3/8"	5/8"	5/16"	20 pieces	200	On Request
137701	1/2"	3/4"	5/16"	20 pieces	200	On Request

## DOG CHAINS

### WALKING CHAINS



150830



- Made of steel with welded, chrome-plated links.
- Reinforced nylon handle with double stitching.

ITEM	CHAIN THICKNESS	☞	AVAILABLE
150830	0.07"	12	On Request
150831	0.09"	12	On Request
150832	0.11"	12	On Request
150833	0.13"	12	On Request
150834	0.15"	12	On Request

### PUNISH CHAIN



150843



- Made of steel with welded, chrome-plated links.
- With metal rings.

ITEM	LENGTH	THICKNESS	☞	AVAILABLE
150843	19.68"	0.11"	12	On Request
150844	21.65"	0.13"	12	On Request
150845	23.62"	0.15"	12	On Request

## PLASTIC TIES

### PLASTIC TIE BOTTLE PRESENTATION



114220



- Strong, multipurpose locking ties, useful at home, office, car, etc.

ITEM	DIMENSIONS	COLOR	QTY.	PIECES	☞	AVAILABLE
114220	11-13/16" x 3/16"	○	100	650	1	On Request
	11-13/16" x 5/32"	○	200			
	7-7/8" x 5/32"	●	50			
	3-15/16" x 3/32"	●	100			
	3-15/16" x 3/32"	●	100			
	3-15/16" x 3/32"	●	100			
114224	3-15/16" x 3/32"	○	100	800	1	On Request
	3-15/16" x 3/32"	●	100			
	3-15/16" x 3/32"	●	200			
	7-7/8" x 5/32"	●	100			
	7-7/8" x 5/32"	○	100			

**PLASTIC TIES**

**PLASTIC TIE IN BAGS**



NEW

• Strong, multipurpose locking ties, useful at home, office, car, etc.

ITEM	LENGTH	WIDTH	COLOR	PIECES	☑	AVAILABLE
<b>Combined plastic tie bag (tension 8 kg - 18 lb)</b>						
114250	3-15/16"	3/32"	○	50	12	On Request
	3-15/16"	3/32"	●	50		
	8"	5/32"	○	50		
	3-15/16"	3/32"	●	50		
<b>Combined plastic tie bag (tension 8 kg - 18 lb)</b>						
114251	8"	5/32"	●	25	1	✓
	8"	5/32"	●	25		
	8"	5/32"	●	25		
	8"	5/32"	●	25		
	3-15/16"	3/32"	○	50		
	3-15/16"	3/32"	●	50		
<b>Plastic tie bag (tension 8 kg - 18 lb)</b>						
114200	3-15/16"	3/32"	○	100	12	On Request
114201	3-15/16"	3/32"	●	100	12	On Request
114202	6-1/2"	3/32"	○	100	12	On Request
114203	6-1/2"	3/32"	●	100	12	On Request
<b>Plastic tie bag (tension 18 kg - 40 lb)</b>						
114204	6"	5/32"	○	50	12	On Request
114205	6"	5/32"	●	50	12	On Request
114252	6"	5/32"	●	50	12	✓
114253	6"	5/32"	●	50	12	✓
114254	6"	5/32"	●	50	12	✓
114255	6"	5/32"	●	50	12	✓
114208	8"	5/32"	○	50	12	On Request
114209	8"	5/32"	●	50	12	On Request

ITEM	LENGTH	WIDTH	COLOR	PIECES	☑	AVAILABLE
<b>Plastic tie bag (tension 22 kg - 50 lb)</b>						
114210	8"	3/16"	○	50	12	On Request
114211	8"	3/16"	●	50	12	On Request
114212	11-13/16"	3/16"	○	50	10	On Request
114213	11-13/16"	3/16"	●	50	10	On Request
114256	11-13/16"	3/16"	●	50	10	✓
114257	11-13/16"	3/16"	●	50	10	✓
114258	11-13/16"	3/16"	●	50	10	✓
114259	11-13/16"	3/16"	●	50	10	✓
114214	14-15/32"	3/16"	○	25	10	On Request
114215	14-15/32"	3/16"	●	25	10	On Request
<b>Plastic tie bag (tension 27 kg - 60 lb)</b>						
114206	6-9/32"	3/16"	○	50	12	On Request
114207	6-9/32"	3/16"	●	50	12	On Request
114216	17-23/32"	3/16"	○	25	10	On Request
114217	17-23/32"	3/16"	●	25	10	On Request
114218	19-11/16"	3/16"	○	25	10	On Request
114219	19-11/16"	3/16"	●	25	10	On Request
<b>Plastic tie bag (tension 55 kg - 121 lb)</b>						
114226	15-3/4"	9/32"	●	50	6	On Request
114225	15-3/4"	9/32"	○	50	6	On Request
<b>Plastic tie bag (tension 70 kg - 154 lb)</b>						
114229	19-11/16"	5/16"	○	50	6	On Request
114230	19-11/16"	5/16"	●	50	6	On Request
114231	21-21/32"	11/32"	○	50	6	On Request
114232	21-21/32"	11/32"	●	50	6	On Request

**TAPES**

**DOUBLE-SIDED TAPE**

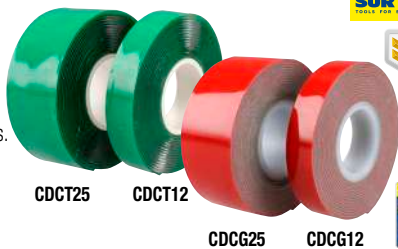

- Made of polyethylene with double-sided acrylic adhesive.
- Adhesive curing time: 24 hours.
- Ideal for fast installation - no nails or screws required.
- Suitable for wood, metal, plastic, concrete, and glass surfaces.

ITEM	WIDTH	LENGTH	USE	☑	AVAILABLE
<b>Transparent face</b>					
CDC112	15/32"	6.56'	Indoor	12	On Request
CDC125	1"	6.56'	Indoor	12	On Request
<b>Gray face</b>					
CDCG12	15/32"	6.56'	Indoor/outdoor	12	On Request
CDCG25	1"	6.56'	Indoor/outdoor	12	On Request

**GRAY DUCT TAPE**



- Made of polyethylene with fabric fibers.
- Waterproof reinforcement resistant to water and humidity.
- Medium adhesion.
- High flexibility prevents twisting or curling of the tape.
- Ideal for carpet and tarp repairs, as well as temporary sealing of PVC and metal pipes.

ITEM	OVERALL DIAMETER	INSIDE DIAMETER	LENGTH	WIDTH	THICKNEES	☑	AVAILABLE
CID01	4.3"	3"	98'	2"	0.006"	1	On Request
CID02	5.12"	3"	164'	2"	0.006"	1	On Request

**ALUMINUM FOIL TAPE**



NEW

- Made of aluminum foil with liner.
- Excellent stability under extreme temperature fluctuations (between -22 °F and 257 °F).
- Medium adhesion.
- Resists water vapor, odors, and smoke transmission.
- Bonds and seals metal ducts and aluminum-reinforced fiberglass insulation; also ideal for metal and sheet-metal repairs.

ITEM	OVERALL DIAMETER	INSIDE DIAMETER	LENGTH	WIDTH	THICKNEES	☑	AVAILABLE
CIAL01	4.4"	3"	98'	2"	0.007"	1	On Request
CIAL02	5.2"	3"	151'	2"	0.007"	1	On Request

**PVC DUCT TAPES (GRAY TAPE)**



- Made of polyethylene reinforced with cotton mesh.
- Protects against humidity and temperature changes.
- Strong bonding provides excellent durability and resistance to sunlight.

ITEM	OVERALL DIAMETER	INSIDE DIAMETER	LENGTH	WIDTH	THICKNEES	☑	AVAILABLE
138040	3.86"	3"	33'	2"	0.01"	3	On Request
138041	5"	3"	98'	2"	0.01"	3	On Request
138042	5.9"	3"	164'	2"	0.01"	3	On Request

## TAPES

### PVC DUCT TAPES



**SURTEK**  
TOOLS FOR SPECIALISTS



- Made of water-resistant PVC.
- Protects against humidity and temperature changes.
- Strong adhesion that offers great durability and UV resistance.



ITEM	OVERALL DIAMETER	INSIDE DIAMETER	LENGTH	WIDTH	THICKNEES	☑	AVAILABLE
138046	5"	3"	150'	2"	0.006"	3	✓

### CLEAR HOT MELT PACKAGING TAPE



**SURTEK**  
TOOLS FOR SPECIALISTS



NEW

- Made of biaxially oriented polypropylene.
- Hot melt adhesive.
- Provides durable sealing on cardboard and paper surfaces.
- Suitable for manual or automatic sealing.



ITEM	OVERALL DIAMETER	INSIDE DIAMETER	LENGTH	WIDTH	THICKNEES	☑	AVAILABLE
138020	3.7"	3"	131'	2"	0.002"	6	On Request
138022	3.8"	3"	164'	2"	0.002"	6	On Request

### BROWN HOT MELT PACKAGING TAPE



**SURTEK**  
TOOLS FOR SPECIALISTS



NEW

- Made of biaxially oriented polypropylene.
- Hot melt adhesive.
- Provides durable sealing on cardboard and paper surfaces.
- Suitable for manual or automatic sealing.



ITEM	OVERALL DIAMETER	INSIDE DIAMETER	LENGTH	WIDTH	THICKNEES	☑	AVAILABLE
138015	3.74"	3"	131'	2"	0.002"	6	On Request
138017	3.86"	3"	164'	2"	0.002"	6	On Request
138018	4.72"	3"	492'	2"	0.002"	6	On Request

### ERGONOMIC TAPE DISPENSER



**URREA**  
PROFESSIONAL CLASS TOOLS



- Made of ABS plastic.
- Heat-treated blade with chrome finish.
- Blade inclined at 10° with center marker.
- Soft rubber handle with 3 positions:  
Left: for right-handed users;  
Center: for quick dispensing;  
Right: for left-handed users.



ITEM	TAPE WIDTH	BODY	☑	AVAILABLE
DCU1	2"	ABS Plastic	1	On Request

### HOT MELT PACKAGING TAPE

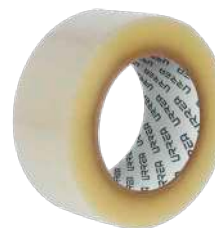

**URREA**  
PROFESSIONAL CLASS TOOLS



VIDEO

- Made of biaxially oriented polypropylene
- Hot melt adhesive, with stronger bonding power on porous surfaces.
- Special release coating for easy and consistent unwinding.
- Provides durable sealing on cardboard and paper surfaces.
- Suitable for manual or automatic sealing.



CIE02

ITEM	OVERALL DIAMETER	INSIDE DIAMETER	LENGTH	WIDTH	THICKNEES	☑	AVAILABLE
CIE01	3.6"	3.1"	164'	1.9"	0.001"	1	On Request
CIE02	4.8"	3.1"	492'	1.9"	0.001"	1	On Request

### ACRILIC PACKING TAPE TRANSPARENT



**SURTEK**  
TOOLS FOR SPECIALISTS



- Made of biaxially oriented polypropylene.
- Water-based acrylic adhesive.
- Provides durable sealing on cardboard and paper surfaces.
- Suitable for manual or automatic sealing.



138026 138025 138024

ITEM	OVERALL DIAMETER	INSIDE DIAMETER	LENGTH	WIDTH	THICKNEES	☑	AVAILABLE
138024	3.7"	3"	131'	2"	0.001"	6	On Request
138025	3.8"	3"	164'	2"	0.001"	6	On Request
138026	4.8"	3"	492'	2"	0.001"	6	On Request

### ACRILIC PACKING TAPE BROWN



**SURTEK**  
TOOLS FOR SPECIALISTS



- Made of biaxially oriented polypropylene.
- Water-based acrylic adhesive.
- Provides durable sealing on cardboard and paper surfaces.
- Suitable for manual or automatic sealing.



138038 138037 138036

ITEM	OVERALL DIAMETER	INSIDE DIAMETER	LENGTH	WIDTH	THICKNEES	☑	AVAILABLE
138036	3.7"	3"	131'	2"	0.001"	6	On Request
138037	3.8"	3"	164'	2"	0.001"	6	On Request
138038	4.8"	3"	492'	2"	0.001"	6	On Request





**TAPES**

**HIGH TEMPERATURE MASKING TAPE**



**CIM06**

- Made of crepe paper.
- Withstands temperatures up to 95°C (203°F) for 30 minutes without losing adhesion or leaving residues.
- Medium-high adhesion.
- Synthetic rubber adhesive.
- UV resistant.
- Designed for indoor and outdoor masking on multiple surfaces.

URREA  
  
  
 VIDEO  
 NEW

ITEM	OVERALL DIAMETER	INSIDE DIAMETER	LENGTH	WIDTH	THICKNESSES	AVAILABILITY
<b>CIM06</b>	4.3"	3.15"	1.89'	164'	0.005"	1 On Request

**BLUE MASKING TAPE**



**138080**

- Made of crepe paper.
- Low adhesion.
- Acrylic emulsion adhesive.
- Designed for indoor and outdoor masking on multiple surfaces.

SURTEK  
  
 IMPROVED PRODUCT  
 NEW

ITEM	OVERALL DIAMETER	INSIDE DIAMETER	LENGTH	WIDTH	THICKNESSES	AVAILABILITY
<b>138080</b>	4.8"	3"	164'	0.51"	0.005"	6 On Request
<b>138081</b>	4.8"	3"	164'	0.75"	0.005"	6 On Request
<b>138082</b>	4.8"	3"	164'	0.94"	0.005"	6 On Request
<b>138083</b>	4.8"	3"	164'	1.42"	0.005"	6 On Request
<b>138084</b>	4.8"	3"	164'	1.89"	0.005"	6 On Request

**BLUE MASKING TAPE**



**CIM03**

- Made of crepe paper.
- Synthetic rubber adhesive prevents tape from peeling off or paint leakage in high-precision jobs.
- Medium adhesion.
- Easily removable after use.
- Leaves no residue and does not damage the surface.
- UV resistant.
- Designed for indoor and outdoor masking on multiple surfaces.

URREA  
  
  
 VIDEO

ITEM	OVERALL DIAMETER	INSIDE DIAMETER	LENGTH	WIDTH	THICKNESSES	AVAILABILITY
<b>CIM01</b>	4.3"	4.33"	164'	0.94"	0.005"	1 On Request
<b>CIM02</b>	4.3"	4.33"	164'	1.42"	0.005"	1 On Request
<b>CIM03</b>	4.3"	4.33"	164'	1.89"	0.005"	1 ✓

**MASKING TAPE**



**138030**

- Made of crepe paper.
- Low adhesion.
- Rubber resin adhesive.
- Designed for indoor and outdoor masking on multiple surfaces.

SURTEK  
  
 IMPROVED PRODUCT

ITEM	OVERALL DIAMETER	INSIDE DIAMETER	LENGTH	WIDTH	THICKNESSES	AVAILABILITY
<b>138030</b>	4.8"	3"	0.51"	164'	0.005"	6 On Request
<b>138031</b>	4.8"	3"	0.75"	164'	0.005"	4 On Request
<b>138032</b>	4.8"	3"	0.94"	164'	0.005"	3 On Request
<b>138033</b>	4.8"	3"	1.42"	164'	0.005"	2 On Request
<b>138034</b>	4.8"	3"	1.89"	164'	0.005"	2 On Request

**SELF-FUSING SILICON TAPE**



RESISTANT TO HIGH TEMPERATURES  
 FUSED AFTER 24 HOURS



**SFTT**

**SFTR**

**SFTB**

- Made of self-fusing silicone.
- Elongation up to 300%.
- Dielectric strength up to 30 kV/mm.
- Insulates up to 8000 V.
- Application temperature: 5°C to 45°C (41°F to 113°F).

URREA  
  
  
 VIDEO  
 NEW

ITEM	LENGTH	WIDTH	THICKNESSES	COLOR	AVAILABILITY
<b>SFTT</b>	9.8"	1"	0.019"	Transparent	12 ✓
<b>SFTR</b>	9.8"	1"	0.019"	●	12 ✓
<b>SFTB</b>	9.8"	1"	0.019"	●	12 On Request

**ELECTRICAL TAPE**



- Made of PVC with high-anchorage acrylic adhesive.
- Highly flexible and easy to remove.
- Elongation up to 250%.
- For primary insulation of joints up to 600 V.
- Resistant to UV rays, oils, acids, corrosive chemicals, and water.
- Temperature resistance: 0°C to 80°C (32°F to 176°F).

URREA  
  
  
 VIDEO  
 NEW

ITEM	OVERALL DIAMETER	INSIDE DIAMETER	LENGTH	WIDTH	THICKNESSES	AVAILABILITY
<b>CIA01</b>	2.95"	1.38"	66'	0.75"	0.007"	1 On Request

**ELECTRICAL TAPE**



**138002\***

**138005**

**138006**

**138008**

**138010**

**138012**

- Made of PVC.
- Moisture resistant.
- Temperature resistance up to 80°C (176°F).
- Ideal for insulating telephone wires, TV and radio antennas, electrical cables, etc.

SURTEK  
  
 IMPROVED PRODUCT

ITEM	OVERALL DIAMETER	INSIDE DIAMETER	LENGTH	WIDTH	THICKNESSES	COLOR	AVAILABILITY
<b>138002*</b>	2.87"	1.22"	59'	0.75"	0.007"	●	6 On Request
<b>138000</b>	2.36"	1.46"	29.5'	0.75"	0.007"	●	6 On Request
<b>138001</b>	2.87"	1.22"	59'	0.75"	0.007"	●	6 On Request
<b>138005</b>	2.36"	1.46"	29.5'	0.75"	0.007"	●	6 On Request
<b>138004</b>	2.87"	1.22"	59'	0.75"	0.007"	●	6 On Request
<b>138007</b>	2.36"	1.46"	29.5'	0.75"	0.007"	●	6 On Request
<b>138006</b>	2.87"	1.22"	59'	0.75"	0.007"	●	6 On Request
<b>138009</b>	2.36"	1.46"	29.5'	0.75"	0.007"	●	6 On Request

ITEM	OVERALL DIAMETER	INSIDE DIAMETER	LENGTH	WIDTH	THICKNESSES	COLOR	AVAILABILITY
<b>138008</b>	2.87"	1.22"	59'	0.75"	0.007"	●	6 On Request
<b>138011</b>	2.36"	1.46"	29.5'	0.75"	0.007"	●	6 On Request
<b>138010</b>	2.87"	1.22"	59'	0.75"	0.007"	●	6 On Request
<b>138013</b>	2.36"	1.46"	29.5'	0.75"	0.007"	○	6 On Request
<b>138012</b>	2.87"	1.22"	59'	0.75"	0.007"	○	6 On Request
<b>137999</b>	2.36"	1.46"	29.5'	0.75"	0.007"	●	6 On Request
<b>138014</b>	2.87"	1.22"	59'	0.75"	0.007"	●	6 On Request

## TAPES

### THREAD SEAL TAPE

**INDUSTRIAL DUTY** **RESISTANT TO HIGH TEMPERATURES**

- Made of polytetrafluoroethylene (PTFE).
- Resistant to extreme temperatures: -260°C to 280°C (-436°F to 536°F).
- Elongation: 50-100%.
- Density: 0.95 g/cm<sup>3</sup>.
- Does not react with steam, water, or chemical agents.
- Ideal for professional pipe sealing, pneumatic and gas installations.



ITEM	OVERALL DIAMETER	INSIDE DIAMETER	LENGTH	WIDTH	THICKNESS	⊞	AVAILABLE
CSE01	2.2"	0.98"	23'	1/2"	0.004"	10	On Request
CSE02	2.2"	0.98"	42'	1/2"	0.004"	10	On Request
CSE03	2.2"	0.98"	42'	3/4"	0.004"	10	On Request
CSE04	2.3"	0.98"	42'	1"	0.004"	10	On Request

### THREAD SEAL TAPE, INDUSTRIAL USE

**PROFESSIONAL USE** **RESISTANT TO HIGH TEMPERATURES**

- Made of polytetrafluoroethylene (PTFE).
- Resistant to high and low temperatures: -100°C to 250°C (-148°F to 482°F).
- Elongation: 14%.
- Density: 0.95 g/cm<sup>3</sup>.
- Resistant to chemical agents.
- Ideal for professional pipe sealing, pneumatic and gas installations.



ITEM	OVERALL DIAMETER	INSIDE DIAMETER	LENGTH	WIDTH	THICKNESS	⊞	AVAILABLE
138049	2.2"	0.98"	23'	1/2"	0.004"	10	On Request
138057	2.2"	0.98"	43'	1/2"	0.004"	10	On Request
138058	2.2"	0.98"	43'	3/4"	0.004"	10	On Request
138059	2.3"	0.98"	43'	1"	0.004"	10	On Request

### THREAD SEAL TAPE

**GENERAL USE**

- Made of polytetrafluoroethylene (PTFE).
- Elongation: 14%.
- Density: 0.30 g/cm<sup>3</sup>.
- Ideal for sealing threads in aluminum, stainless steel, copper, and plastic.



ITEM	OVERALL DIAMETER	INSIDE DIAMETER	LENGTH	WIDTH	THICKNESS	⊞	AVAILABLE
138050	2.2"	0.98"	23'	1/2"	0.003"	10	On Request
138053	2.2"	0.98"	23'	3/4"	0.003"	10	On Request
138055	2.3"	0.98"	23'	1"	0.003"	10	On Request

ITEM	OVERALL DIAMETER	INSIDE DIAMETER	LENGTH	WIDTH	THICKNESS	⊞	AVAILABLE
138052	2.2"	0.98"	43'	1/2"	0.003"	10	On Request
138054	2.2"	0.98"	43'	3/4"	0.003"	10	On Request
138056	2.3"	0.98"	43'	1"	0.003"	10	On Request

## STAPLER-NAILER

### 3 IN 1 FUNCTION STAPLER-NAILER

- INDUSTRIAL DUTY**
- T50° STAPLE 6-14 mm (1/4"-9/16")**
- No. 8 BRAD NAIL 12-14 mm (1/2"-9/16")**
- No. 9 PIN NAIL 14 mm (9/16")**



- Normal and Trigger modes.
- Impact force regulator.
- Made of aluminum, plastic, and metal.
- Design without loose parts.
- With trigger firing function.
- Designed for one-hand operation for easy handling and to reach any corner.
- Soft rubber grip and handle.
- With reload indicator and easy loading system.

ITEM	STAPLE	STAPLE TYPE	NAIL	⊞	AVAILABLE
UEC31	1/4 - 9/16	T-50	No.8 - No.9	1	On Request

### METALLIC STAPLER, PISTOL TYPE WITH PRESSURE ADJUSTMENT

**PROFESSIONAL USE** **5/32" - 5/16" STAPLES**

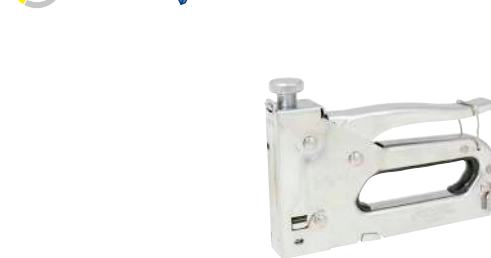

- Made of steel.
- Knob for pressure adjustment.

ITEM	STAPLE SIZE	TYPE	MEASURE	⊞	AVAILABLE
114301	5/32" to 9/16"	T21	7/16" and caliber 0.8 mm	1	✓

### METALLIC STAPLER, PISTOL TYPE WITH PRESSURE ADJUSTMENT

**PROFESSIONAL USE** **5/32" - 5/16" STAPLES**



- Made of steel.
- With rear nail remover to take out staples.

ITEM	STAPLE SIZE	TYPE	MEASURE	⊞	AVAILABLE
114300	5/32" to 5/16"	T-21	7/16" and Caliber 0.8 mm	1	✓

### STAPLES FOR MANUAL STAPLER

**PROFESSIONAL USE**

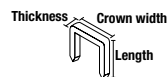

- 1,000 staples per box.

ITEM	STAPLES FOR MANUAL STAPLER	LENGTH	CROWN	THICKNESS	⊞	AVAILABLE
114351	114301/114300	1/4"	7/16"	0.8 mm	1	On Request
114352	114301/114300	5/16"	7/16"	0.8 mm	1	On Request
114353	114301	3/8"	7/16"	0.8 mm	1	On Request
114354	114301	1/2"	7/16"	0.8 mm	1	On Request
114355	114301	9/16"	7/16"	0.8 mm	1	On Request
114360	114302	1/4"	13/32"	1.3 mm	1	On Request
114361	114302	5/16"	13/32"	1.3 mm	1	On Request

**LADDERS**

**FIBERGLASS LADDER TYPE II**

PROFESSIONAL USE **386 LB** MAX LOAD CAPACITY

ANSI OSHA Safe use with electricity



- Professional lid with tool slot.
- Anti pinch braces.
- Shock absorption system.
- Ladder rungs with non-slip surface.
- Professional anti-slip boot.

SURTEK TOOLS FOR SPECIALISTS



**BULK**

ITEM	ETFV25	ETFV27
FT.	6	8
STEPS	5	7
LADDER TOTAL HEIGHT	6.1'	8.1'
MAX. HEIGHT TO STAND	3.8'	5.7'
MAXIMUM WORK HEIGHT	10.3'	12.27'
LOAD CAPACITY	385.81 lb	385.81 lb
APPROXIMATE WEIGHT	14.33 lb	20.63 lb
VOLUME	6 ft3	8.82 ft3
☞	1	1
AVAILABLE	On Request	On Request

**ALUMINUM LADDER TYPE STOOL**

GENERAL USE **198 LB** MAX LOAD CAPACITY

- Anti pinch braces.
- Slip-resistant feet.

SURTEK TOOLS FOR SPECIALISTS



- Made of aluminum.
- You can stand on the top cap and use it as a work platform.

**BULK**

ITEM	STEPS	HEIGHT	☞	AVAILABLE
TT2	2	2'	1	On Request

**FIBERGLASS EXTENSION LADDER TYPE II**

PROFESSIONAL USE **386 LB** MAX LOAD CAPACITY

ANSI OSHA Safe use with electricity



Pulley and rope system.



Quick latch.



Sliding guides.



Double action heel with rubber that prevents skidding.

- Made of fiberglass.
- Ideal for electricians.

**BULK**

ITEM	EEFV224
STEPS	24
LADDER TOTAL HEIGHT	21.03'
MAX. HEIGHT TO STAND	17.29'
MAX. SCOPE OF WORK	23.85'
LOAD CAPACITY	385.81 lb
APPROXIMATE WEIGHT	50.08 lb
VOLUME	10.94 ft3
☞	1
AVAILABLE	On Request

SURTEK TOOLS FOR SPECIALISTS



**BRACKETS**

**ANGLE BRACKETS**

GENERAL USE

SURTEK TOOLS FOR SPECIALISTS



**NEW**



- Bag with 24 pieces.
- Galvanized steel body.
- Pre-drilled holes for better fastening.
- With angular reinforcement.
- Ideal for supporting objects or reinforcing corners.

**BULK**

ITEM	HEIGHT	LENGTH	WIDTH	THICKNESS	DRILLED HOLE DIAMETER	☞	AVAILABLE
EES1	0.98"	0.98"	0.6"	0.06"	0.19"	1	On Request
EES112	1.57"	1.57"	0.6"	0.06"	0.19"	1	On Request
EES2	1.97"	1.97"	0.6"	0.06"	0.19"	1	On Request
EES238	2.36"	2.36"	0.6"	0.06"	0.19"	1	On Request
EES318	3.15"	3.15"	0.6"	0.06"	0.19"	1	On Request

**BRACKETS WITH SUPPORT**

PROFESSIONAL USE

- Made of steel.
- Electrostatic paint finish.
- Thickness 3.8 mm = 0.15 in.
- 6 fixing points.
- With cross support for higher load capacity.



SURTEK TOOLS FOR SPECIALISTS



**NEW**

**BULK**

ITEM	SIZE	LOAD CAPACITY	COLOR	☞	AVAILABLE
<b>White</b>					
137826	8 x 12"	550 lb	○	10	On Request
137827	10 x 16"	550 lb	○	10	On Request
137828	13 x 20"	550 lb	○	10	On Request
<b>Black</b>					
137823	8 x 12"	550 lb	●	10	On Request
137824	10 x 16"	550 lb	●	10	On Request
137825	13 x 20"	550 lb	●	10	On Request
<b>Gray</b>					
137820	8 x 12"	550 lb	●	10	On Request
137821	10 x 16"	550 lb	●	10	On Request
137822	13 x 20"	550 lb	●	10	On Request

**BRACKETS**

GENERAL USE

- Made of steel.
- Electrostatic paint finish.
- Thickness: 1 mm = 0.039 in.
- 6 fixing points.



SURTEK TOOLS FOR SPECIALISTS



**BULK**

ITEM	SIZE	LOAD CAPACITY	COLOR	☞	AVAILABLE
<b>White</b>					
137790	4 x 5"	33 lb	○	12	On Request
137791	5 x 6"	33 lb	○	12	On Request
137792	6 x 8"	33 lb	○	12	On Request
137793	8 x 10"	44 lb	○	12	On Request
137794	10 x 12"	55 lb	○	12	On Request
137795	12 x 14"	55 lb	○	24	On Request
<b>Black</b>					
137796	4 x 5"	33 lb	●	12	On Request
137797	5 x 6"	33 lb	●	12	On Request
137798	6 x 8"	33 lb	●	12	On Request
137799	8 x 10"	44 lb	●	12	On Request
137800	10 x 12"	55 lb	●	12	On Request
137801	12 x 14"	55 lb	●	12	On Request

## SANDPAPER

### WATERPROOF SANDPAPER



- Silicon carbide grain.
- Backing of durable flexible waterproof paper.
- Size: 9" x 11".
- Provides optimal results for wet and dry sanding.
- Suitable for non-ferrous metals, plastic, lacquer, paint, and glass.
- For manual or machine use.



ITEM	GRAIN	☞	AVAILABLE	ITEM	GRAIN	☞	AVAILABLE	ITEM	GRAIN	☞	AVAILABLE	ITEM	GRAIN	☞	AVAILABLE
LAG80	80	25	On Request	LAG180	180	25	On Request	LAG320	320	25	On Request	LAG600	600	25	On Request
LAG100	100	25	On Request	LAG220	220	25	On Request	LAG360	360	25	On Request	LAG1000	1000	25	On Request
LAG120	120	25	On Request	LAG240	240	25	On Request	LAG400	400	25	On Request	LAG1200	1200	25	On Request
LAG150	150	25	On Request	LAG280	280	25	On Request	LAG500	500	25	On Request				

### EMERY SANDPAPER



- Aluminum oxide grain.
- Backing of flexible cotton cloth resistant to friction.
- Size: 9" x 11".
- Suitable for wood, ferrous and non-ferrous metals.



**LER36**  
• For plastic, lacquer, paint, and glass.



**LEN36**  
• For manual or machine use.

ITEM	GRAIN	TYPE	☞	AVAILABLE	ITEM	GRAIN	TYPE	☞	AVAILABLE
LER36	36	Red	25	On Request	LEN36	36	Black	25	On Request
LER50	50	Red	25	On Request	LEN50	50	Black	25	On Request
LER80	80	Red	25	On Request	LEN80	80	Black	25	On Request
LER120	120	Red	25	On Request	LEN120	120	Black	25	On Request

### WOOD SANDPAPER



- Aluminum oxide grain.
- Lightweight, waterproof, and durable paper backing.
- Size: 9" x 11".
- For heavy sanding.
- For manual or machine use.



**LMC36**  
• Cabinet paper: for wood, moldings, ferrous and non-ferrous metals, plastic, lacquer, and paint.



**LMK60**  
• Kraft paper: for wood.

ITEM	GRAIN	TYPE	☞	AVAILABLE	ITEM	GRAIN	TYPE	☞	AVAILABLE
LMC80	80	Cabinet	25	On Request	LMK60	60	Kraft	25	On Request
LMC100	100	Cabinet	25	On Request	LMK100	100	Kraft	25	✓
LMC120	120	Cabinet	25	On Request					
LMC180	180	Cabinet	25	On Request					

### PLUMBER'S ABRASIVE CLOTH ROLLS



NEW



LR5120

- Aluminum oxide grain with heavy cotton cloth backing.
- Strong and durable for heavy-duty work.
- For removal and cleaning of welds.



ITEM	GRAIN	ROLL	☞	AVAILABLE
LR5120	120	16.4 ft	12	✓
LR45120	120	147.64 ft	1	✓

**TARPS**

**REINFORCED TARPS**



LR1X2

Silver color reflecting the sun.



LR1X2A



LR1X2B

- Black backing that prevents heating.
- Density: 180 g/m<sup>2</sup> = 5.3 oz/yd<sup>2</sup>.
- Mesh: 14 x 14 threads per inch.
- Thickness: 0.25 mm = 0.0098 in.
- Greater durability and resistance.

ITEM	METERS	FOOTS	COLOR	☑	AVAILABLE	ITEM	METERS	FOOTS	COLOR	☑	AVAILABLE
LR1X2	1.5 x 2 m	4.92 x 6.56 ft	●	1	On Request	LR1X2A	1.5 x 2 m	4.92 x 6.56 ft	●	5	On Request
LR2X3	2 x 3 m	6.56 x 9.84 ft	●	1	On Request	LR2X3A	2 x 3 m	6.56 x 9.84 ft	●	1	On Request
LR3X3	3 x 3 m	9.84 x 9.84 ft	●	1	On Request	LR3X3A	3 x 3 m	9.84 x 9.84 ft	●	1	On Request
LR3X4	3 x 4 m	9.84 x 13.13 ft	●	1	On Request	LR3X4A	3 x 4 m	9.84 x 13.13 ft	●	1	On Request
LR3X5	3 x 5 m	9.84 x 16.40 ft	●	1	On Request	LR4X5A	4 x 5 m	13.13 x 16.40 ft	●	2	On Request
LR3X6	3 x 6 m	9.84 x 19.68 ft	●	1	On Request	LR4X6A	4 x 6 m	13.13 x 19.68 ft	●	1	On Request
LR4X4	4 x 4 m	13.13 x 13.13 ft	●	1	On Request	LR5X6A	5 x 6 m	16.40 x 19.85 ft	●	1	On Request
LR4X5	4 x 5 m	13.13 x 16.40 ft	●	1	On Request	LR6X12A	6 x 12 m	19.85 x 39.37 ft	●	1	On Request
LR4X6	4 x 6 m	13.13 x 19.68 ft	●	1	On Request	LR12X17A	12 x 17 m	39.37 x 55.77 ft	●	1	On Request
LR5X5	5 x 5 m	16.40 x 16.40 ft	●	1	On Request	LR2X3B	2 x 3 m	6.56 x 9.84 ft	○	1	On Request
LR5X6	5 x 6 m	16.40 x 19.85 ft	●	1	On Request	LR3X3B	3 x 3 m	9.84 x 9.84 ft	○	1	On Request
LR5X7	5 x 7 m	16.40 x 22.96 ft	●	1	On Request	LR3X4B	3 x 4 m	9.84 x 13.13 ft	○	1	On Request
LR6X6	6 x 6 m	19.68 x 19.68 ft	●	1	On Request	LR4X5B	4 x 5 m	13.13 x 16.40 ft	○	1	On Request
LR6X9	6 x 9 m	19.68 x 29.52 ft	●	1	On Request	LR4X6B	4 x 6 m	13.13 x 19.68 ft	○	1	On Request
LR6X12	6 x 12 m	19.85 x 39.37 ft	●	1	On Request	LR5X6B	5 x 6 m	16.40 x 19.85 ft	○	1	On Request
LR7X10	7 x 10 m	22.96 x 32.80 ft	●	1	On Request	LR6X12B	6 x 12 m	19.85 x 39.37 ft	○	1	On Request
LR12X17	12 x 17 m	39.37 x 55.77 ft	●	1	On Request	LR12X17B	12 x 17 m	39.37 x 55.77 ft	○	1	On Request

**SHADE NET ROLL**



- Made of high-density polyethylene.
- Black shade mesh.
- Provides 80% shade.
- UV protection.
- Ideal for greenhouses, sports centers, social and domestic use.

ITEM	SIZE	CONTENT	☑	AVAILABLE
ROM25	25 x 1,85 m / 82 x 6 ft	1 roll	1	✓

**SUN SHADE CLOTH**



- Made of high-density polyethylene.
- Black shade mesh.
- Provides 80% shade.
- Thread gauge: 12.
- Reinforced edge with metal grommets.
- UV protection.
- Ideal for greenhouses, sports centers, social and domestic use.

ITEM	SIZE	CONTENT	☑	AVAILABLE
TOLM3	3 x 3.6 m = 9.84 x 11.81 ft	1 piece	1	✓
TOLM5	5 x 3.6 m = 16.40 x 11.81 ft	1 piece	1	✓

## WINDOWS SCREENS

### GALVANIZED STEEL WINDOW SCREEN



**SURTEK**  
TOOLS FOR SPECIALISTS



**NEW**



- Manufactured in galvanized steel in a single piece without seams or welds.
- Galvanized steel mesh.
- Corrosion resistant.
- High resistance to deformation and breakage.
- Uniform openings that allow the passage of air, light, and sound.
- Ideal for door and window frames, prevents the entry of insects.

ITEM	SIZE	THICKNESS	AVAILABILITY
MMG92	3.02 ft x 36.1 ft	0.015"	1 On Request

### ALUMINUM WINDOW SCREEN



**SURTEK**  
TOOLS FOR SPECIALISTS



**NEW**

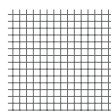

**138104**  
Roll



**138101**  
With cardboard core

- Made of aluminum.
- Wire diameter: 0.009".
- 18 x 14 mesh per inch.
- Rust resistant.
- Protective coating that strengthens and improves appearance.

- Made of aluminum.
- Wire diameter: 0.009".
- 18 x 14 mesh per inch.
- Rust resistant.
- Protective coating that strengthens and improves appearance.

ITEM	SIZE	DESCRIPTION	AVAILABILITY
138104	3 ft x 6.9 ft	Roll	9 On Request
138105	3.9 ft x 6.9 ft	Roll	9 On Request
138100	2 ft x 98.4 ft	With cardboard core	1 On Request
138101	3 ft x 98.4 ft	With cardboard core	1 On Request
138102	3.9 ft x 98.4 ft	With cardboard core	1 On Request

### PLASTIC MESH SCREEN



**SURTEK**  
TOOLS FOR SPECIALISTS



**NEW**

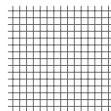

**138115**  
With cardboard core



**138109**  
With cardboard core

- Manufactured with high-density polyethylene.
- Weight per m<sup>2</sup>: 0.065 kg.
- 16.5 x 16.5 threads per square inch.
- Taffeta-type weave.
- Edges with overlock stitching to reinforce and improve product presentation.
- Maximum thread elongation: 20–25%.

- Manufactured with high-density polyethylene.
- Weight per m<sup>2</sup>: 0.065 kg.
- 16.5 x 16.5 threads per square inch.
- Taffeta-type weave.
- Edges with overlock stitching to reinforce and improve product presentation.
- Maximum thread elongation: 20–25%.

ITEM	SIZE	COLOR	AVAILABILITY
138113	23.6 in x 98.4 ft	●	1 On Request
138114	29.5 in x 98.4 ft	●	1 On Request
138115	35.4 in x 98.4 ft	●	1 On Request
138116	41.3 in x 98.4 ft	●	1 On Request
138117	47.2 in x 98.4 ft	●	1 On Request
138118	59.0 in x 98.4 ft	●	1 On Request
138119	1.7 x 30 m	●	1 On Request
138106	23.6 in x 98.4 ft	●	1 On Request
138107	29.5 in x 98.4 ft	●	1 On Request
138108	35.4 in x 98.4 ft	●	1 On Request
138109	41.3 in x 98.4 ft	●	1 On Request
138110	47.2 in x 98.4 ft	●	1 On Request
138111	59.0 in x 98.4 ft	●	1 On Request
138112	1.7 x 30 m	●	1 On Request

**RIVETERS**

**LAZY TONG RIVETER**



- Body made of high-strength aluminum.
- Reinforced steel link system for better mechanical performance.
- Includes 5 interchangeable rivet nozzles.
- Wrench for nozzle change.
- Greater impact force.



ITEM	NOZZLES	☞	AVAILABLE
UPS25	1/8", 5/32" 3/16", 15/64" and 1/4"	1	✓

**HEAVY DUTY RIVETER**



- Body made of steel with neoprene handles.
- Reduces the effort required thanks to the additional leverage action.



ITEM	NOZZLES	☞	AVAILABLE
112516	1/8" 5/32" and 3/16" / 3.2, 4.0, 4.8 mm	1	On Request

**LAZY TONG RIVETER**



- Body made of steel with zamak handle.
- Includes 5 interchangeable rivet nozzles.
- Wrench for nozzle change.



ITEM	NOZZLES	☞	AVAILABLE
112515	1/8", 5/32", 3/16", 1/4" and 15/64" / 3.2, 4.0, 4.8, 6.0 and 6.4 mm	1	On Request

**HAND RIVETER 10"**



- High-strength aluminum body.
- Two hardened jaws system for better rivet holding.
- Includes 4 interchangeable nozzles for rivets.
- Wrench for nozzle changing.
- Greater impact force.



ITEM	NOZZLES	☞	AVAILABLE
UPS15	3/32", 1/8", 5/32" and 3/16"	1	✓

**MANUAL RIVETER WITH SWIVEL HEAD**



- Made of steel with vinyl handle.
- Swivel head for use at different angles.
- One-hand operation.
- Includes nozzles and special wrench for nozzle changing.



ITEM	NOZZLES	☞	AVAILABLE
112513	3/32", 1/8", 5/32" and 3/16" / 2.4, 3.2, 4.0 and 4.8 mm	1	On Request

**RIVETERS GUNS**



112521



112520

- Made of steel with vinyl handle.
- Long nose that does not require jaw adjustment.
- Includes 4 nozzles.
- Wrench for nozzle changing.
- Includes 60 rivets.



ITEM	NOZZLES	☞	AVAILABLE
112521	3/32", 1/8", 5/32" and 3/16" / 2.4, 3.2, 4.0 and 4.8 mm	1	On Request

- Made of steel with vinyl handle.
- Long nose that does not require jaw adjustment.
- Includes 4 nozzles.
- Wrench for nozzle changing.



ITEM	NOZZLES	☞	AVAILABLE
112520	3/32", 1/8", 5/32" and 3/16" / 2.4, 3.2, 4.0 and 4.8 mm	1	On Request

## RIVETS

### 1/8" DIAMETER RIVETS



- Aluminum body.
- Steel nail.
- Maximum grip range from 1/8" to 1/2".

ITEM	WIDTH IN (A)	GRIP IN (B)	WIDTH MM (A)	GRIP MM (B)	PIECES PER BOX	PIECES PER BAG	☞	AVAILABLE
113400	1/8"	1/8"	3.18	3.18	1000	100	1	On Request
113401	1/8"	3/16"	3.18	4.76	1000	100	1	On Request
113402	1/8"	1/4"	3.18	6.35	1000	100	1	On Request
113403	1/8"	5/16"	3.18	7.94	1000	100	1	On Request
113404	1/8"	3/8"	3.18	9.53	1000	100	1	On Request
113405	1/8"	1/2"	3.18	12.7	1000	100	1	On Request

### 5/32" DIAMETER RIVETS



- Aluminum body.
- Steel nail.
- Maximum grip range from 1/8" to 1/2".

ITEM	WIDTH IN (A)	GRIP IN (B)	WIDTH MM (A)	GRIP MM (B)	PIECES PER BOX	PIECES PER BAG	☞	AVAILABLE
113406	5/32"	1/8"	3.97	3.18	1000	100	1	On Request
113407	5/32"	1/4"	3.97	6.35	1000	100	1	On Request
113408	5/32"	3/8"	3.97	9.53	500	100	1	On Request
113409	5/32"	1/2"	3.97	12.7	500	100	1	On Request

### 3/16" DIAMETER RIVETS



- Aluminum body.
- Steel nail.
- Maximum grip range from 1/8" to 3/4".

ITEM	WIDTH IN (A)	GRIP IN (B)	WIDTH MM (A)	GRIP MM (B)	PIECES PER BOX	PIECES PER BAG	☞	AVAILABLE
113410	3/16"	1/8"	4.76	3.18	500	100	1	On Request
113411	3/16"	1/4"	4.76	6.35	500	100	1	On Request
113412	3/16"	3/8"	4.76	9.53	500	100	1	On Request
113414	3/16"	5/8"	4.76	15.88	250	50	1	On Request
113415	3/16"	3/4"	4.76	19.05	250	50	1	On Request

### 1/4" DIAMETER RIVETS



- Aluminum body.
- Steel nail.
- Maximum grip range from 1/4" to 1/2".

ITEM	WIDTH IN (A)	GRIP IN (B)	WIDTH MM (A)	GRIP MM (B)	PIECES PER BOX	PIECES PER BAG	☞	AVAILABLE
113418	1/4"	1/4"	6.35	6.35	250	50	1	On Request
113419	1/4"	3/8"	6.35	9.53	250	50	1	On Request
113420	1/4"	1/2"	6.35	12.7	250	50	1	On Request

### 3/16" RIVETS DIAMETER WIDE HEAD



Wide head

- Aluminum body.
- Steel nail.
- Maximum grip range from 3/8" to 1/2".
- Greater clamping area.

ITEM	WIDTH IN (A)	GRIP IN (B)	WIDTH MM (A)	GRIP MM (B)	PIECES PER BOX	PIECES PER BAG	☞	AVAILABLE
113416	3/16"	3/8"	4.76	9.53	500	100	1	On Request
113417	3/16"	1/2"	4.76	12.7	500	100	1	On Request

## DRYWALL STILTS

### DRYWALL STILTS



- Adjustable stilts with double safety system.
- Capacity of 105 kg / 230 lb.
- Aluminum body.
- Equipped with grip straps for greater safety, plus a padded calf brace for added comfort.
- Adjustable support to reach the desired height.



131000



RPZANCO

RBZANCO

ITEM	DESCRIPTION	☞	AVAILABLE	ITEM	DESCRIPTION	☞	AVAILABLE
131000	Elevation 18" to 30"	1	On Request	Replacements			
				RBZANCO **	Replacement shoe	2	On Request
				RPZANCO **	Stilt foot replacement	2	On Request





CLASS	TYPE	PAGE	BRAND		
			Lock	Prolok	ProForza
Hinges	Steel hinges	652			•
	Double-action hinges	653			•
	Stainless steel hinges	653		•	
	Bidimensional hinges	653			•
		654			•
Boxes	Security metal safes	655			•
Mailbox	Mailbox	655			•
Padlocks	High-security padlocks	656			•
	Alarm padlocks	657			•
	Brass padlocks	658	•		•
	Steel padlocks	661	•		•
	Waterproof padlocks	664			•
	Laminated padlocks	665	•		•
	Combination padlocks	666			•
	Roll door padlocks	667	•		•
	Cable padlocks	669			•
	Motorcycle lock	670			•
Locks	Door handle	671	•	•	•
	Handle with mortise mechanism	673		•	
	Lever locks	674		•	
	Tubular lever locks	674		•	•
	Cylindrical handles	676	•		•
	Deadbolt locks	677	•		•
	Tubular knobs	678	•		•
	Cylindrical knobs	681	•		
	Digital locks	682			•
	Aluminum door locks	683			•
Panic bars	Panic bars	684	•		•
Handles	Bar handles	685			•
Accessories for closet	Closet trolley rail	686			•
	Rails and tubes for closet	687			•
Accessories for doors and windows	Rollers for gates and windows	687			•
	Hydraulic door closers	688	•		•
	Door stop	689			•
	Door seal	690			•
	Door guards	691			•
	Barrel bolts	692			•
	Coat hooks	693			•
	Door hasp	693			•
	Letters and numbers	694			•

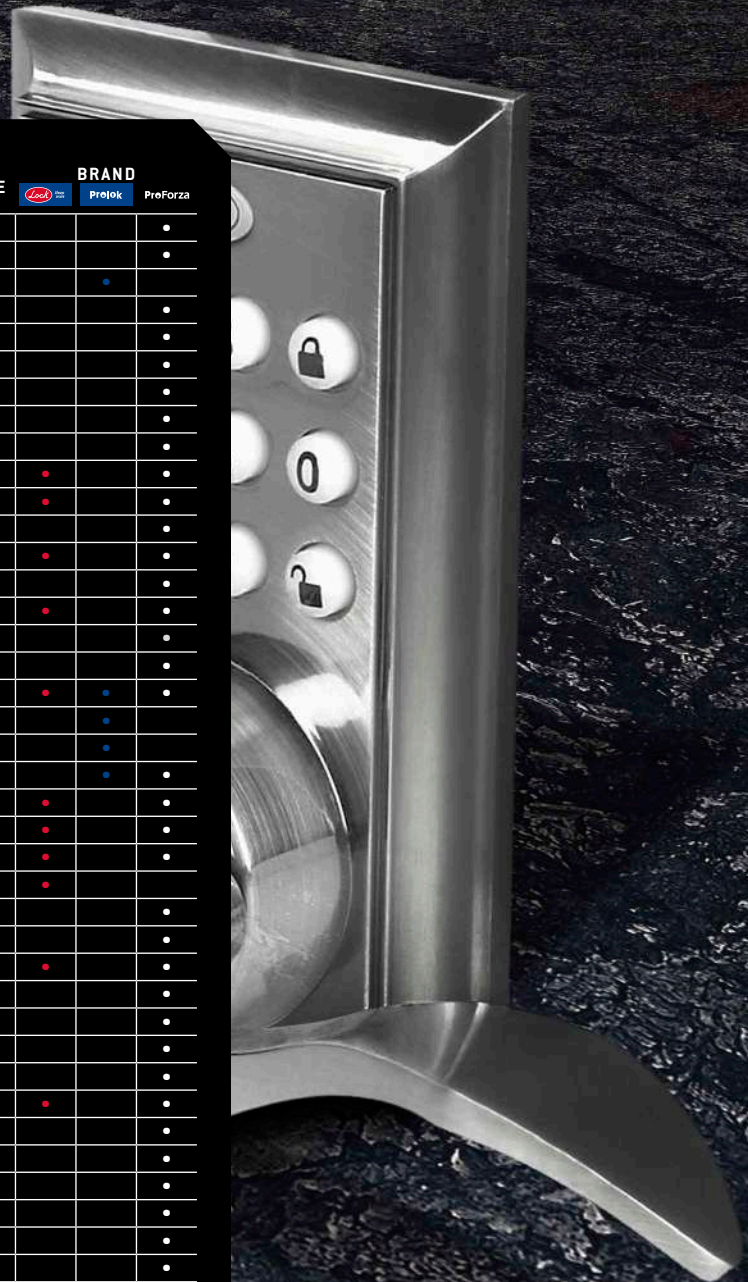

usa.urea.com

We are constantly improving our products, that is why the information, characteristics and availability of them can change without prior notice.

# WARRANTY

## LOCK, PROLOK AND PROFORZA

Urrea Professional Tools and its locksmith division **that the products offered are Proforza, Lock and Prolok brands are free from defects in workmanship and materials.** We agree to replace or repair any product that has failed during its useful life due to defects attributable to workmanship and materials, provided that they are used under normal conditions and in accordance with the specific warranty of the particular product, free of charge and directly at the place of purchase or an authorized dealer.

Our locksmith product line **are designed to offer the highest security** to users and with the best quality. They are made by our highly competent, trained and experience personnel with the best material.

**The guarantee is void if:**

- The product has been used in conditions other than normal, due to the natural wear of its parts, maintenance and storage that leads to damage to the product due to humidity or dust that results in corrosion or erosion. In addition to any other post sale, transportation and handling activities.
- The product has not been installed or operated according to the accompanying instructions for use.

- The product has been altered by replacement of parts or repaired by unauthorized persons.

**Our guarantee is subject to the following conditions:**

- The products must be identified from their origin with the permanent brand **Proforza, Lock and Prolok.**
- That the failure was the result of a manufacturing defect, either in your workmanship or materials.

Proforza, Lock and Prolok reserve the right not to repair or replace the product that has been **abused, modified, exceeded or used incorrectly** or without proper maintenance.

Some products such as fittings, accessories, hinges, among others that contain moving parts are subject to wear and tear due to normal use, so it is expected that the user will replace these products after their useful life has expired.

PERFORMANCE TABLE Safety HIGH SECURITY STANDARD SECURITY Architectural Use Proforza, Lock and Prolok steel hinges are not responsible for personal injury and damage that may result from misuse, abuse, alteration or use beyond the expected life of its products.

# SECURITY

## AND PERFORMANCE CHART

ProForza							
SECURITY	ARCHITECTURAL LINE		WARRANTY	SECURITY	ARCHITECTURAL LINE		WARRANTY
USE	HIGH SECURITY	STANDARD SECURITY		USE	HIGH SECURITY	STANDARD SECURITY	
Steel hinges		●	15 YEAR WARRANTY	Sets	●		50 YEAR WARRANTY
Locks	●		50 YEAR WARRANTY	Handles	●		
Cylinders	●						

\* Warranty against manufacturing defect (labor and materials).  
\* Valid guarantee unless the product packaging specifies a different one.



SECURITY	EXTREME SECURITY		HIGH SECURITY		STANDARD SECURITY		WARRANTY
	COMERCIAL LINE	RESIDENCIAL LINE	ARCHITECTURAL LINE	COMERCIAL LINE	RESIDENCIAL LINE	ARCHITECTURAL LINE	
USE							
Hardware and accessories							5 YEAR WARRANTY
Furniture accessories				●			10 YEAR WARRANTY
Hinges				●	●		
Bidimensional hinges						●	
Combination padlocks						●	
Steel padlocks	●	●		●	●	●	20 YEAR WARRANTY
Brass padlocks	●	●				●	
Waterproof padlocks						●	
Laminated padlocks						●	
No. 9 padlocks						●	
Panic exit device						●	25 YEAR WARRANTY
Floor hinges door						●	
Bar locks						●	
Deadbolts				●	●	●	
Knobs						●	
Rim locks						●	
Dowels for smithy						●	
Locks for aluminum doors						●	
Mounted latches					●	●	
Cylinders				●	●	●	
Sets					●	●	
Door handle sets			●	●	●		
Handles			●	●	●	●	

## Prolok

SECURITY	SEGURIDAD ESTÁNDAR		WARRANTY	SECURITY	SEGURIDAD ESTÁNDAR		WARRANTY	
USE	LÍNEA COMERCIAL	LÍNEA RESIDENCIAL		USE	LÍNEA COMERCIAL	LÍNEA RESIDENCIAL		
Bidimensional hinges	●	●	5 YEAR WARRANTY	Rim locks		●	20 YEAR WARRANTY	
Panic exit device	●			10 YEAR WARRANTY	Cylinders			●
Steel padlocks	●	●	Door handle sets			●		●
Brass padlocks		●			Handles			
Laminated padlocks		●						

\* Warranty against manufacturing defect (labor and materials).  
\* Valid guarantee unless the product packaging specifies a different one.



# GOOD, BETTER, BEST

We are the **complete solution in tools** where you will find the best of Grupo Urrea all in one place.

Thinking of you and your various needs, we offer a wide range of possibilities with **Good, Better & Best** options within our extensive product catalog.

## *Get to know them in detail:*

**GOOD-** Commercial or residential standard security level: **Prolok**

**BETTER-** Standard, high and extreme security level, for commercial, reresidential and architectural: **Lock**

**BEST-** High security and specialized in architectural use: **ProForza**



## **GOOD**

Wide variety, availability and accessibility.



## **BETTER**

Wide variety, availability, accessibility and performance, with an excellent price-quality.



## **BEST**

Wide variety, availability, technology and innovation, High quality and superior.

Choose better, choose quality with our  
**new 2026 catalog**

# CATALOG

## LINES & ICONOGRAPHY



**COMERCIAL**

COMERCIAL LINE 

Locks and accessories designed to offer **security and tranquility** in high-traffic places such as offices, hotels, lounges, hospitals and more, manufactured under strict quality standards.



**RESIDENTIAL**

RESIDENTIAL LINE 

Locks and accessories of **great resistance and duration**, which exceed the expectations of the user for their excellent performance and security. Designed and manufactured for residential use, focusing on meeting the needs of homes.



**ARCHITECTURAL**

ARCHITECTURAL LINE 

Locks with **design and innovation** that make them the perfect option for projects of an avant-garde architectural line. Without leaving security aside.

**PADLOCKS**

SECURITY FEATURES

Based on the conditions of use and handling, it indicates the characteristics contained in the padlocks.



**KEYS**

AMOUNT AND TYPE

Indicates the type of keys and the number of copies that are supplied with the product.



**NEW**

PRODUCTS

Indicates families of new and improved products.



**CYLINDER**

TYPE

Indicates the type of key cylinder and the number of pins, keys, or discs that are made up of the product



**PRODUCT**

INFORMATION

Indicates technical information, uses and recommendations.



## STEEL HINGES

### SQUARE ARCHITECTURAL HINGES

COMERCIAL LINE LOOSE PIN INCLUDES INSTALLATION ACCESSORIES



33BL



- Made of steel.
- 40% thicker than conventional ones, providing higher load capacity.
- Smooth opening and closing.
- High-quality luxury finishes.
- Loose pin and 2 bearings.
- Two flat heads.

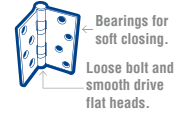

ITEM	FINISH	DIMENSIONS (A X B)		THICKNESS		HOLES	PACKING	⊞	AVAILABLE
32BL	Satin nickel	3.5" x 3.5"	89 x 89 mm	2.15 mm	0.085"	6	Box	3	On Request
33BL	Satin nickel	4" x 4"	101 x 101 mm	2.5 mm	0.098"	8	Box	3	On Request
34BL	Satin nickel	4.5" x 4.5"	114 x 114 mm	3.4 mm	0.13"	8	Box	3	On Request

### SQUARE LOOSE BOLT HINGES WITH FLAT HEADS

RESIDENTIAL LINE LOOSE PIN INCLUDES INSTALLATION ACCESSORIES



- Made of steel.
- High-quality luxury finishes.
- Loose pin.
- Two flat heads.



LBC30NS

LBC30LB

LBC30LA

LBC30B

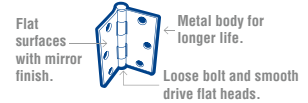

ITEM	LBC20NS	LBC25NS	LBC30NS	LBC35NS	LBC40NS	LBC20LB	LBC25LB	LBC30LB	LBC35LB	LBC40LB	LBC20LA	LBC25LA	LBC30LA	LBC35LA	LBC40LA	LBC30B
FINISH	Satin nickel ●					Polished brass ●					Antique brass ●					Black ●
DIMENSIONS (A X B)																
IN	2" x 2"	2.5" x 2.5"	3" x 3"	3.5" x 3.5"	4" x 4"	2" x 2"	2.5" x 2.5"	3" x 3"	3.5" x 3.5"	4" x 4"	2" x 2"	2.5" x 2.5"	3" x 3"	3.5" x 3.5"	4" x 4"	3" x 3"
MM	51 x 51	63 x 63	76 x 76	89 x 89	101 x 101	51 x 51	63 x 63	76 x 76	89 x 89	101 x 101	51 x 51	63 x 63	76 x 76	89 x 89	101 x 101	76 x 76
THICKNESS																
IN	0.06"	0.07"	0.08"	0.09"	0.10"	0.06"	0.07"	0.08"	0.09"	0.10"	0.06"	0.07"	0.08"	0.09"	0.10"	0.08"
MM	1 mm	2 mm	2 mm	2 mm	2 mm	1 mm	2 mm	2 mm	2 mm	2 mm	1 mm	2 mm	2 mm	2 mm	2 mm	2 mm
HOLES	4	6	6	6	8	4	6	6	6	8	4	6	6	6	8	6
PACKING	Box	Box	Box	Box	Box	Box	Box	Box	Box	Box	Box	Box	Box	Box	Box	Blister
⊞	10	10	10	10	10	10	10	10	10	10	10	10	10	10	10	10
AVAILABLE	On Request	On Request	On Request	On Request	On Request	On Request	On Request	On Request	On Request	On Request	On Request	On Request	On Request	On Request	On Request	On Request

### ELONGATED STUD BOLT HINGES WITH FLAT HEADS

RESIDENTIAL LINE FIXED PIN INCLUDES INSTALLATION ACCESSORIES



- Made of steel.
- High-quality luxury finishes.
- Riveted pin.
- Two flat heads.



LBA35NI

LBA35LB

LBA35LA

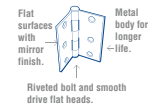

ITEM	LBA10NI	LBA15NI	LBA20NI	LBA25NI	LBA30NI	LBA35NI	LBA40NI	LBA10LB	LBA15LB	LBA20LB	LBA25LB	LBA30LB	LBA35LB	LBA40LB	LBA15LA	LBA20LA	LBA25LA	LBA30LA	LBA35LA	LBA40LA
FINISH	Satin nickel ●							Polished brass ●							Antique brass ●					
DIMENSIONS (A X B)																				
IN	1" x 1.06"	1.5" x 1.46"	2" x 1.61"	2.5" x 1.81"	3" x 2.08"	3.5" x 2.52"	4" x 2.87"	1" x 1.06"	1.5" x 1.46"	2" x 1.61"	2.5" x 1.81"	3" x 2.08"	3.5" x 2.52"	4" x 2.87"	1.5" x 1.46"	2" x 1.61"	2.5" x 1.81"	3" x 2.08"	3.5" x 2.52"	4" x 2.87"
MM	25 x 27	38 x 37	51 x 41	64 x 46	76 x 53	89 x 64	102 x 73	25 x 27	38 x 37	51 x 41	64 x 46	76 x 53	89 x 64	102 x 73	38 x 37	51 x 41	64 x 46	76 x 53	89 x 64	102 x 73
THICKNESS																				
IN	0.04"	0.05"	0.05"	0.05"	0.06"	0.06"	0.07"	0.04"	0.05"	0.05"	0.05"	0.06"	0.06"	0.07"	0.05"	0.05"	0.05"	0.06"	0.06"	0.07"
MM	1 mm	1 mm	1 mm	1 mm	1 mm	1 mm	2 mm	1 mm	1 mm	1 mm	1 mm	1 mm	1 mm	1 mm	1 mm	1 mm	1 mm	1 mm	1 mm	2 mm
HOLES	4	4	4	6	6	6	8	4	4	4	6	6	6	8	4	4	6	6	6	8
PACKING	Box	Box	Box	Box	Box	Box	Box	Box	Box	Box	Box	Box	Box	Box	Box	Box	Box	Box	Box	Box
⊞	10	10	10	10	10	10	10	10	10	10	10	10	10	10	10	10	10	10	10	10
AVAILABLE	On Request	On Request	On Request	On Request	On Request	On Request	On Request	On Request	On Request	On Request	On Request	On Request	On Request	On Request	On Request	On Request	On Request	On Request	On Request	On Request

## STAINLESS STEEL HINGES

### SQUARE HINGES WITH BEARINGS, RIVETED PIN AND FLAT HEAD

ProForza

ARCHITECTURAL LINE



FIXED PIN



INCLUDES INSTALLATION ACCESSORIES



STAINLESS STEEL



- Made of stainless steel.
- Bearing system.
- Smoother opening and closing.
- Riveted pin with 2 bearings.
- Two flat heads.



ITEM	DIMENSIONS (A X B)		THICKNESS	HOLES	PACKING	AVAILABILITY
BICS20	2" x 2"	51 x 51 mm	1 mm	0.06"	6	Box 10 On Request
BICS25	2.5" x 2.5"	63 x 63 mm	2 mm	0.07"	6	Box 10 On Request
BICS30	3" x 3"	76 x 76 mm	2 mm	0.08"	6	Box 10 On Request
BICS35	3.5" x 3.5"	89 x 89 mm	2 mm	0.09"	6	Box 10 On Request
BICS40	4" x 4"	101 x 101 mm	2 mm	0.10"	8	Box 10 On Request

## DOUBLE ACTION STAINLESS STEEL HINGES

### DOUBLE ACTION HINGE SETS

Lock

COMERCIAL LINE



INCLUDES INSTALLATION ACCESSORIES



2 PIECES



10BR



11BR



- Made of stainless steel.
- High-quality finishes.
- For heavy-duty use with adjustable tension.
- Load capacity of 10–18 kg per pair.

ITEM	FINISH	SIZE	PACKING	AVAILABILITY
10BR	Black	3"	Blister 1	On Request
11BR	Polished brass	3"	Blister 1	On Request

## BIDIMENSIONAL HINGES

### NUMBER OF HINGES PER DOOR

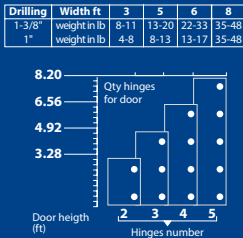

### IDEAL MEASURES TO DRILL THE DOOR

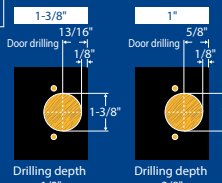

### THREE INDEPENDENT ADJUSTMENT

#### LATERAL ADJUSTMENT

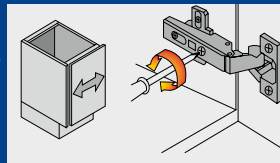

#### HEIGHT ADJUSTMENT

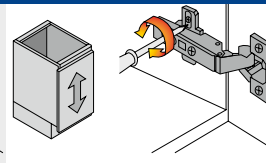

#### DEPTH ADJUSTMENT

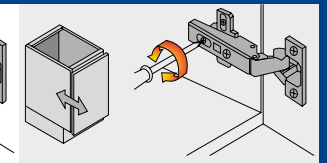

### ANGLED HINGE

RESIDENTIAL LINE



INCLUDES INSTALLATION ACCESSORIES



Lock

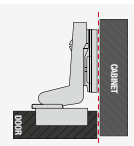

- With piston.
- Internal coverage.
- Price per bag with 2 pieces.



ITEM	HOLE DIAMETER	ANGLE	AVAILABILITY
LBD35AP	1-3/8"	105°	1 On Request

### CURVED HINGE

RESIDENTIAL LINE



INCLUDES INSTALLATION ACCESSORIES



Lock

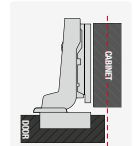

- With piston.
- Half overlay.
- Price per bag with 2 pieces.



ITEM	HOLE DIAMETER	ANGLE	AVAILABILITY
LBD35CP	1-3/8"	105°	1 On Request

### STRAIGHT HINGE

RESIDENTIAL LINE



INCLUDES INSTALLATION ACCESSORIES



Lock

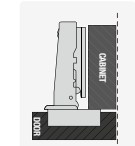

- With piston.
- Full overlay.
- Price per bag with 2 pieces.



ITEM	HOLE DIAMETER	ANGLE	AVAILABILITY
LBD35RP	1-3/8"	105°	1 On Request

## BIDIMENSIONAL HINGES

### CURVED HINGE

RESIDENTIAL LINE  INCLUDES INSTALLATION ACCESSORIES 

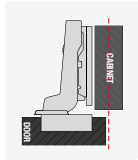

- Half overlay.
- Price per bag with 2 pieces.

ITEM	HOLE DIAMETER	ANGLE	QTY	AVAILABLE
LBD26C	1-1/32"	95°	1	On Request
LBD35C	1-3/8"	110°	1	On Request

### STRAIGHT HINGE

RESIDENTIAL LINE  INCLUDES INSTALLATION ACCESSORIES 

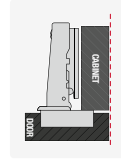

- Full overlay.
- Price per bag with 2 pieces.

ITEM	HOLE DIAMETER	ANGLE	QTY	AVAILABLE
LBD26R	1-1/32"	95°	1	On Request
LBD35R	1-3/8"	110°	1	On Request

### 135° CORNER HINGE

RESIDENTIAL LINE  INCLUDES INSTALLATION ACCESSORIES 

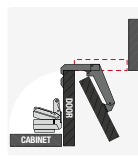

- Half overlay.
- Price per bag with 2 pieces.

ITEM	HOLE DIAMETER	ANGLE	QTY	AVAILABLE
LBD135E	1-3/8"	135°	1	On Request

### 165° CORNER HINGE

RESIDENTIAL LINE  INCLUDES INSTALLATION ACCESSORIES 

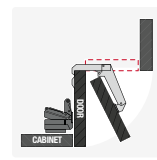

- Full overlay.
- Price per bag with 2 pieces.

ITEM	HOLE DIAMETER	ANGLE	QTY	AVAILABLE
LBD165E	1-3/8"	165°	1	On Request

### FRONT FRAME HINGE

RESIDENTIAL LINE  INCLUDES INSTALLATION ACCESSORIES 

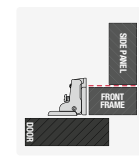

- Full overlay.
- Price per bag with 2 pieces.

ITEM	HOLE DIAMETER	ANGLE	QTY	AVAILABLE
LBDM	1-3/8"	110°	1	On Request

## STEEL HINGES FOR BLACKSMITH

### TUBULAR HINGES

RESIDENTIAL LINE 



LBT1

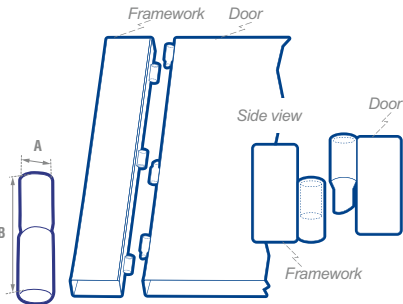

- Made of forged steel.
- Natural finish.
- For welding installation.
- Design that reduces friction.
- Ideal for metal doors and windows.

ITEM	DIAMETER (A)	LENGTH (B)	QTY	AVAILABLE
LBT38	3/8"	1-7/8"	20	On Request
LBT12	1/2"	2-1/8"	20	✓
LBT58	5/8"	2-5/8"	20	On Request
LBT34	3/4"	3"	10	On Request
LBT1	1"	3-3/4"	6	On Request

## PIANO HINGES

### PIANO HINGES

RESIDENTIAL LINE 

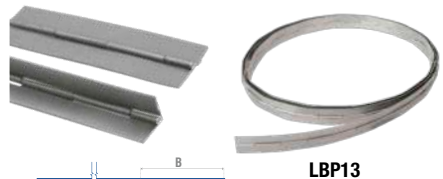

LBP13

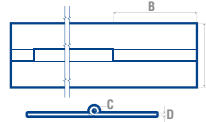

ITEM	A in	B in	C in	D in	LENGTH feet
SECTIONS					
LBP1	1	1.14	0.07	0.02	3.28
LBP2	1-1/4	1.14	0.07	0.02	3.28
LBP3	1-1/2	1.14	0.07	0.02	3.28
COIL					
LBP13	1	0.59	0.07	0.02	11.48
LBP23	1-1/4	0.59	0.07	0.02	11.48
LBP33	1-1/2	0.59	0.07	0.02	11.48

- Made of carbon steel.
- Ideal for folding tables, folding bars, and metal furniture.

ITEM	FINISH	WIDTH	LENGTH	PACKING	QTY	AVAILABLE
LBP1	Natural	1"	3.28 ft	Box	10	✓
LBP2	Natural	1-1/4"	3.28 ft	Box	10	On Request
LBP3	Natural	1-1/2"	3.28 ft	Box	10	On Request
LBP13	Natural	1"	11.48 ft	Box	1	On Request
LBP23	Natural	1-1/4"	11.48 ft	Box	1	On Request
LBP33	Natural	1-1/2"	11.48 ft	Box	1	On Request

### PIANO HINGES WITH HOLES

RESIDENTIAL LINE 

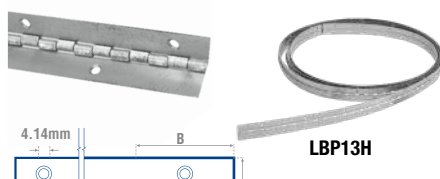

LBP13H

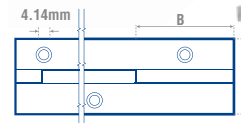

ITEM	A in	B in	C in	D in	LENGTH feet
SECTION					
LBP1H	1	1.18	0.07	0.02	3.28
LBP2H	1-1/4	1.18	0.07	0.02	3.28
LBP3H	1-1/2	1.18	0.07	0.02	3.28
COIL					
LBP13H	1	0.59	0.07	0.02	11.48
LBP23H	1-1/4	0.59	0.07	0.02	11.48
LBP33H	1-1/2	0.59	0.07	0.02	11.48

- Made of carbon steel.
- Ideal for folding tables, folding bars, and metal furniture.

ITEM	FINISH	WIDTH	LENGTH	PACKING	QTY	AVAILABLE
LBP1H	Natural	1"	3.28 ft	Box	10	On Request
LBP2H	Natural	1-1/4"	3.28 ft	Box	10	On Request
LBP3H	Natural	1-1/2"	3.28 ft	Box	10	On Request
LBP13H	Natural	1"	11.48 ft	Box	1	On Request
LBP23H	Natural	1-1/4"	11.48 ft	Box	1	On Request
LBP33H	Natural	1-1/2"	11.48 ft	Box	1	On Request



## MAILBOXES

### MAILBOXES

RESIDENTIAL LINE

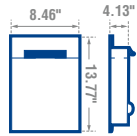
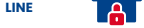

10BZ

11BZ

- Manufactured in 14-gauge steel sheet.
- For installation in steel doors or to be welded onto grilles.
- Wide slot for envelopes.
- Drop-down collection door.
- Padlock holder.
- Weather resistant.

ITEM	COLOR	DIMENSIONS	PACKING	☐	AVAILABLE
10BZ	White	8.46" x 13.77" x 4.13"	Box	1	✓
11BZ	Black	8.46" x 13.77" x 4.13"	Box	1	On Request

## CASH BOXES

### METAL CASH BOXES

COMERCIAL LINE STANDARD SECURITY

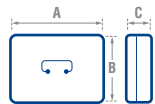

CDI30



- Made of 24-gauge steel sheet.
- Removable tray with 5 compartments.
- Solid metal handle.

ITEM	DIVIDERS	DIMENSION A	DIMENSION B	DIMENSION C	☐	AVAILABLE
CDI20	5	7.9"	6.3"	3.5"	1	On Request
CDI30	5	11.8"	9.4"	3.5"	1	On Request

### COMBINATION METAL KEY BOX

COMERCIAL LINE STANDARD SECURITY

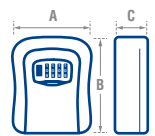

CLLC5

- Made of aluminum alloy.
- Wall mount design.
- Suitable for outdoor use.
- Ideal for handing over keys to housekeepers, property rentals, or forgotten keys.
- 4-digit combination lock.

ITEM	CAPACITY	DIMENSION A	DIMENSION B	DIMENSION C	☐	AVAILABLE
CLLC5	5 keys	3.54"	4.57"	1.50"	1	On Request

## SECURITY METAL SAFES

### SECURITY SAFES

COMERCIAL LINE EXTREME SECURITY DIGITAL COMBINATION



31CFU

35CFU

41CFU

2 STANDARD KEYS

- Made of steel.
- Opening system with code or key.
- 3 to 8 digit combinations.
- Contains 2 bolts for greater security.
- Uses 4 AA batteries (not included).

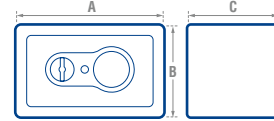

ITEM	DIMENSIONS (IN)			CAPACITY	WEIGHT	☐	AVAILABLE
	INTERNAL	EXTERNAL	A x B x C				
31CFU	12.1" x 7.8" x 5.5"	12.2 x 7.9 x 7.9"	2.25 gal	12.1 lb	1	On Request	
35CFU	13.7" x 9.7" x 7.5"	13.8 x 9.8 x 9.8"	4.23 gal	17.6 lb	1	On Request	
41CFU	15.8" x 10.8" x 8.9"	15.9 x 13.2 x 9.1"	6.6 gal	20.9 lb	1	On Request	

## KEY BOXES

### KEYS BOXES

COMERCIAL LINE STANDARD SECURITY

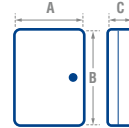

CLL36

CLL60

2 STANDARD KEYS

- Made of 22-gauge steel sheet.
- Includes key tags.
- Numbered labels.

ITEM	CAPACITY	A	B	C	☐	AVAILABLE
CLL36	36 keys	6.3"	7.9"	3"	1	On Request
CLL60	60 keys	7.9"	9.8"	3"	1	On Request



## HIGH SECURITY PADLOCK

### HIGH SECURITY PADLOCKS, DISC KEY



LCAC60

LCAC50

LCAC40



ITEM	A in	B in	C in	D in	E in	THK in
LCAC40	1.57	1.41	1.37	0.31	1.33	0.86
LCAC50	1.96	1.57	1.69	0.39	1.49	0.86
LCAC60	2.36	1.73	1.92	0.47	1.96	0.86

- Extra-strong padlock designed for high-security areas.
- Thermoset-hardened shackle resistant to cutting.
- Hardened steel body highly resistant to all types of physical attacks.



ITEM	WIDTH	LEVEL	PINS	PACKING	📦	AVAILABLE
LCAC40	1.57"	10	7	Blister	1	On Request
LCAC50	1.96"	10	8	Blister	1	On Request
LCAC60	2.36"	10	9	Blister	1	On Request

### HIGH-LEVER PADLOCKS, DISC KEYS



These characteristics apply to:  
L22A60DCSB & L22A70DCSB



L22A70DCSB

L22A60DCSB

L22A50DCSB

L22A40DCSB



ITEM	A in	B in	C in	D in	E in	THK in
L22A40DCSB	1.57	1.96	0.78	0.27	0.39	0.78
L22A50DCSB	1.96	2.36	0.90	0.31	0.59	0.78
L22A60DCSB	2.36	2.75	1.06	0.35	0.70	0.78
L22A70DCSB	2.75	2.95	0.90	0.39	0.74	0.78

- Hardened steel body.
- Springless cylinder for extra protection.
- Tempered metal shackle resistant to cutting and prying attacks.



ITEM	WIDTH	LEVEL	DISCS	PACKING	📦	AVAILABLE
L22A40DCSB	1.57"	7	6	Blister	1	On Request
L22A50DCSB	1.96"	8	7	Blister	1	On Request
L22A60DCSB	2.36"	8	7	Blister	1	On Request
L22A70DCSB	2.75"	8	7	Blister	1	On Request

### ARMORED HOOK PADLOCKS



19CA

19CA



ITEM	A in	B in	C in	D in	E in	THK in
19CA	1.96	2.77	0.77	0.34	1.04	0.98
20CA	2.55	3.48	25.4	1.00	0.42	1.14

- Solid brass cylinder.
- Iron body coated with nylon.



ITEM	WIDTH	LEVEL	DISCS	PACKING	📦	AVAILABLE
19CA	1.96"	10	10	Blister	1	On Request
20CA	2.55"	10	10	Blister	1	On Request

## HIGH SECURITY PADLOCK

### ROUND PADLOCKS, STANDARD KEY

COMERCIAL LINE EXTREME SECURITY SECURITY LEVEL **7** ANTI-SAW ANTI-SHOCK DOUBLE LOCK



L22L65EACB

L22S65EACB

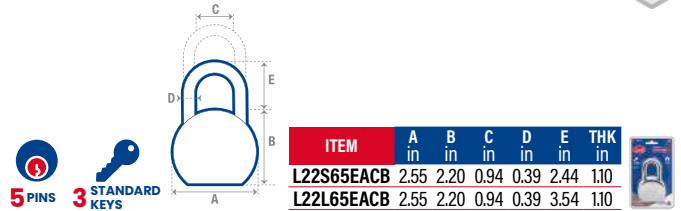

ITEM	WIDTH	LEVEL	PINS	PACKING	☞	AVAILABLE
<b>Short shackle</b>						
L22S65EACB	2.55"	7	5	Blister	1	On Request
<b>Long shackle</b>						
L22L65EACB	2.55"	7	5	Blister	1	On Request

### HOOK TYPE HIGH SECURITY PADLOCKS

COMERCIAL LINE EXTREME SECURITY SECURITY LEVEL **10** ANTI-SAW ANTI-SHOCK ANTI-CUT



55CA

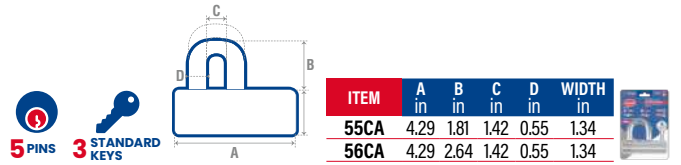

ITEM	WIDTH	LEVEL	PINS	PACKING	☞	AVAILABLE
<b>Short shackle</b>						
55CA	4.3"	10	5	Blister	1	On Request
<b>Long shackle</b>						
56CA	4.3"	10	5	Blister	1	✓

### DISC TYPE HIGH SECURITY PADLOCK

COMERCIAL LINE EXTREME SECURITY SECURITY LEVEL **10** ANTI-SAW ANTI-CUT STAINLESS STEEL

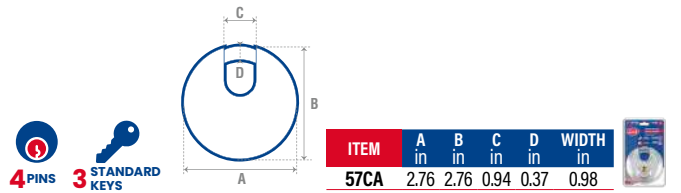

ITEM	DIAMETER	LEVEL	PINS	PACKING	☞	AVAILABLE
57CA	2.75"	10	4	Blister	1	On Request

## PADLOCK WITH ALARM

### DOUBLE LOCK PADLOCK WITH ALARM

COMERCIAL LINE HIGH SECURITY SECURITY LEVEL **6** ANTI-SHOCK DOUBLE LOCK ((110 dB)) BATTERIES INCLUDED

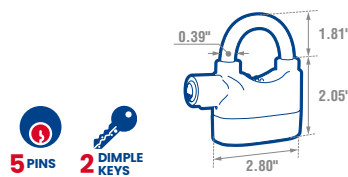
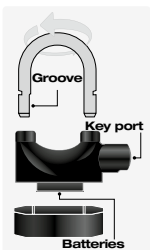

- Aluminum alloy body.
- Chrome-plated steel shackle.
- Cylinder with solid brass body.
- Alarm activates when vibration or movement is detected.

ITEM	WIDTH	LEVEL	PINS	PACKING	☞	AVAILABLE
CAS070	2,76"	6	5	Blister	1	On Request

## SOLID BRASS PADLOCKS

### STANDARD KEYS PADLOCKS SET

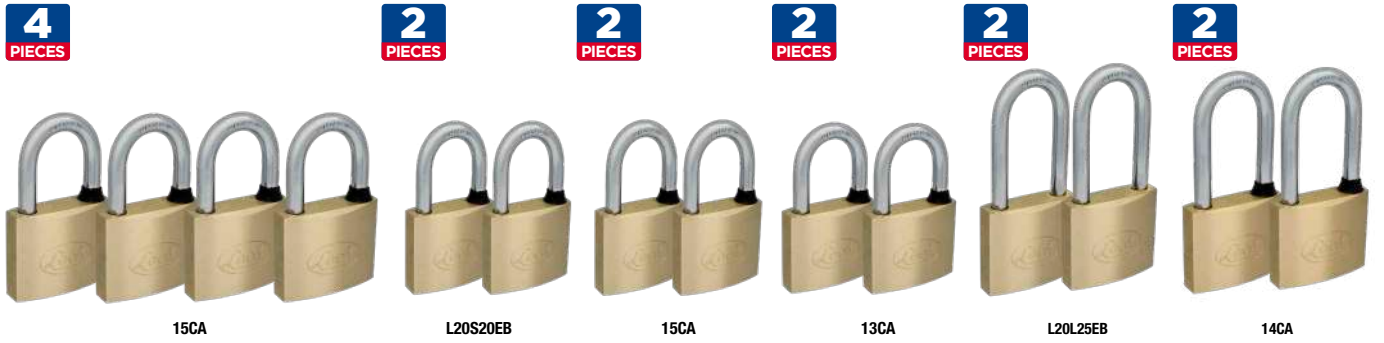

ITEM	15CA	L20S20EB	L20S25EB	13CA	L20L25EB	14CA
		Short shackle			Long shackle	
WIDTH	1.57"	0.78"	0.98"	1.57"	0.98"	1.57"
LEVEL	3	3	3	3	3	3
PINS	5	3	3	5	3	5
PACKING	Blister	Blister	Blister	Blister	Blister	Blister
📦	1	1	1	1	1	1
AVAILABLE	On Request	On Request	On Request	On Request	On Request	On Request

### STANDARD KEYS PADLOCKS SET



ITEM	12CAP	10CAP	11CAP
	Short shackle		Long shackle
WIDTH	1.57"	1.57"	1.57"
LEVEL	3	3	3
PINS	5	5	5
PACKING	Blister	Blister	Blister
📦	1	1	1
AVAILABLE	On Request	On Request	On Request

## SOLID BRASS PADLOCKS

### TUBULAR KEY PADLOCKS



L20S60BB      L20S50BB      L20S40BB

ITEM	A in	B in	C in	D in	E in	THK in
L20S40BB	1.57	1.33	0.82	0.27	1.22	0.78
L20S50BB	1.96	1.45	1.06	0.31	1.45	0.74
L20S60BB	2.36	1.61	1.30	0.39	1.81	0.74

ITEM	WIDTH	LEVEL	PINS	PACKING	☑	AVAILABLE
L20S40BB	1.57"	5	7	Blister	1	On Request
L20S50BB	1.96"	6	7	Blister	1	On Request
L20S60BB	2.36"	6	7	Blister	1	On Request

### DIMPLE KEY PADLOCK



L20S60QB      L20S50QB      L20S40QB

ITEM	A in	B in	C in	D in	E in	THK in
L20S40QB	1.57	1.33	0.82	0.31	1.22	0.86
L20S50QB	1.96	1.45	1.06	0.35	1.57	0.86
L20S60QB	2.36	1.61	1.29	0.39	1.81	0.94

ITEM	WIDTH	LEVEL	PINS	PACKING	☑	AVAILABLE
L20S40QB	1.57"	6	5	Blister	1	On Request
L20S50QB	1.96"	6	5	Blister	1	On Request
L20S60QB	2.36"	7	5	Blister	1	On Request

### TETRA KEY PADLOCK



L20S60TB      L20S50TB      L20S40TB

ITEM	A in	B in	C in	D in	E in	THK in
L20S40TB	1.57	1.29	0.82	0.27	1.22	0.86
L20S50TB	1.96	1.45	1.06	0.35	1.57	0.86
L20S60TB	2.36	1.61	1.29	0.39	1.87	0.94

ITEM	WIDTH	LEVEL	PINS	PACKING	☑	AVAILABLE
L20S40TB	1.57"	5	12	Blister	1	On Request
L20S50TB	1.96"	5	12	Blister	1	On Request
L20S60TB	2.36"	6	12	Blister	1	On Request

## SOLID BRASS PADLOCKS

### STANDARD KEY PADLOCKS



ITEM	A in	B in	C in	D in	E in	THK in
L20S30EB	1.18	1.10	0.63	0.20	0.83	0.51
L20S40EB	1.57	1.30	0.87	0.24	1.14	0.55
L20S45EB	1.77	1.38	0.98	0.28	1.34	0.55
L20S50EB	1.97	1.57	1.06	0.31	1.46	0.63
L20L30EB	1.18	1.10	0.63	0.20	1.30	0.51
L20L40EB	1.57	1.30	0.87	0.24	1.42	0.55
L20L45EB	1.77	1.38	0.98	0.28	1.89	0.55
L20L50EB	1.97	1.57	1.06	0.31	1.97	0.63
L20X30EB	1.18	1.10	0.63	0.20	2.87	0.51
L20X40EB	1.57	1.30	0.87	0.24	3.15	0.55
L20X50EB	1.97	1.57	1.06	0.31	3.07	0.63

ITEM	WIDTH	LEVEL	PINS	PACKING	⊞	AVAILABLE
<b>Short shackle</b>						
L20S30EB	1.18"	3	4	Blister	1	On Request
L20S40EB	1.57"	3	5	Blister	1	On Request
L20S45EB	1.77"	3	5	Blister	1	On Request
L20S50EB	1.97"	4	5	Blister	1	On Request
<b>Long shackle</b>						
L20L30EB	1.18"	3	4	Blister	1	On Request
L20L40EB	1.57"	3	5	Blister	1	On Request
L20L45EB	1.77"	3	5	Blister	1	On Request
L20L50EB	1.97"	4	5	Blister	1	On Request
<b>Extra long shackle</b>						
L20X30EB	1.18"	3	4	Blister	1	On Request
L20X40EB	1.57"	3	5	Blister	1	On Request
L20X50EB	1.97"	4	5	Blister	1	On Request

### BRASS PADLOCK, STANDARD KEY



L18S50EB

ITEM	A in	B in	C in	D in	E in	THK in
L18S50EB	1.97	1.46	1.02	0.28	1.34	0.63

ITEM	WIDTH	LEVEL	PINS	PACKING	⊞	AVAILABLE
L18S50EB	1.97"	4	5	Blister	1	On Request



## STEEL PADLOCKS

### STANDARD KEY, SHORT SHACKLE PADLOCK SET

**3**



**4**  
PIECES



L22S384

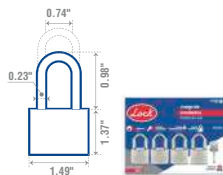

**4**  
PIECES



J4CL

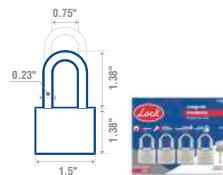

**2**  
PIECES



L22S382

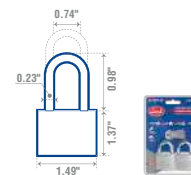

**2**  
PIECES



L22L382

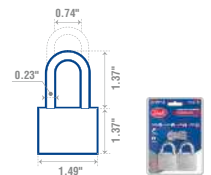

**4** PINS **3** STANDARD KEYS

ITEM	L22S384	J4CL	L22S382	L22L382
PIECES	4	4	2	2
WIDTH	1.49"	1.49"	1.49"	1.49"
PACKING	Blister	Blister	Blister	Blister
	1	1	1	1
AVAILABLE	On Request	On Request	On Request	On Request

### STANDARD KEY, SHORT SHACKLE PADLOCK SET

**4**



**2**  
PIECES



L22S452



**2**  
PIECES



L22L452

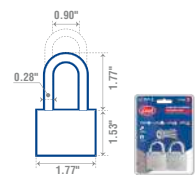

**5** PINS **3** STANDARD KEYS

ITEM	L22S452	L22L452
PIECES	2	2
WIDTH	1.77"	1.77"
PACKING	Blister	Blister
	1	1
AVAILABLE	On Request	On Request

## STEEL PADLOCKS, STANDARD KEY

### STEEL PADLOCK SETS, STANDARD KEY

COMERCIAL LINE STANDARD SECURITY SECURITY LEVEL **3** ANTI-SAW ANTI-SHOCK SAME COMBINATION DOUBLE LOCK

Prolok



NEW

**4**  
PIECES



P22S384

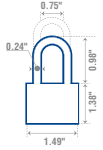

**2**  
PIECES



P22S382

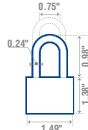

**2**  
PIECES



P22L382

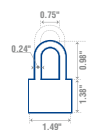

**2**  
PIECES



P22S452

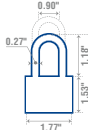

**4** PINS **3** STANDARD KEYS

ITEM	P22S384	P22S382	P22L382	P22S452
PIECES	4	2	2	2
WIDTH	1.49"	1.49"	1.49"	1.77"
PACKING	Blister	Blister	Blister	Blister
	1	1	1	1
AVAILABLE	On Request	On Request	On Request	On Request

### SET OF 2 STEEL PADLOCKS, LONG SHACKLE 45 MM, STANDARD KEY

COMERCIAL LINE STANDARD SECURITY SECURITY LEVEL **3** ANTI-SAW SAME COMBINATION DOUBLE LOCK

Prolok



NEW

**2**  
PIEZAS



**4** PINS **3** STANDARD KEYS



ITEM	P22L452
PIECES	2
WIDTH	1.77"
PACKING	Blister
	1
AVAILABLE	On Request

### DISC KEY PADLOCK

COMERCIAL LINE STANDARD SECURITY SECURITY LEVEL **5** ANTI-SAW ANTI-SHOCK ANTI-PICK

Lock



ANTI-DRILL

These characteristics apply to:  
L22S60DCSB & L22L60DCSB

DOUBLE LOCK



L22L40DCSB

L22S40DCSB

ITEM	A in	B in	C in	D in	E in	THK in
L22S40DCSB	1.59	1.28	0.80	0.27	1.11	0.80
L22S50DCSB	1.96	1.49	0.90	0.35	1.45	0.80
L22S60DCSB	2.36	1.69	1.06	0.39	1.77	0.80
L22L40DCSB	1.59	1.28	0.80	0.27	2.32	0.80
L22L50DCSB	1.96	1.49	0.90	0.27	2.71	0.80
L22L60DCSB	2.36	1.69	1.06	0.39	2.95	0.80

ITEM	WIDTH	LEVEL	PACKING		AVAILABLE
<b>Short shackle</b>					
L22S40DCSB	1.59"	5	Blister	1	On Request
L22S50DCSB	1.96"	6	Blister	1	On Request
L22S60DCSB	2.36"	6	Blister	1	On Request
<b>Long shackle</b>					
L22L40DCSB	1.59"	5	Blister	1	On Request
L22L50DCSB	1.96"	6	Blister	1	On Request
L22L60DCSB	2.36"	6	Blister	1	On Request



## STEEL PADLOCKS

### STANDARD KEY PADLOCKS

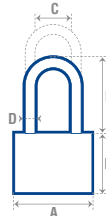

ITEM	A in	B in	C in	D in	E in	THK in
L22S38EACB / L22S38A	1.49	1.37	0.74	0.23	0.98	0.70
L22S45EACB / L22S45A	1.77	1.53	0.90	0.27	1.18	0.82
L22S50EACB / L22S50A	1.96	1.69	0.98	0.35	1.37	0.90
L22L38EACB / L22L38A	1.49	1.37	0.74	0.23	1.37	0.70
L22L45EACB / L22L45A	1.77	1.53	0.90	0.27	1.77	0.82
L22L50EACB / L22L50A	1.96	1.69	0.98	0.35	1.88	0.90



L22S50EACB L22S45EACB L22S38EACB L22L50EACB L22L45EACB L22L38EACB



ITEM	WIDTH	LEVEL	PINS	PACKING	AVAILABLE
<b>Short shackle</b>					
L22S38EACB	1.49"	3	4	Blister	On Request
L22S45EACB	1.77"	4	5	Blister	On Request
L22S50EACB	1.96"	4	5	Blister	On Request
L22S38A	1.49"	3	4	Box	On Request
L22S45A	1.77"	4	5	Box	On Request
L22S50A	1.96"	4	5	Box	On Request
<b>Long shackle</b>					
L22L38EACB	1.49"	3	4	Blister	On Request
L22L45EACB	1.77"	4	5	Blister	On Request
L22L50EACB	1.96"	4	5	Blister	On Request
L22L38A	1.49"	3	4	Box	On Request
L22L45A	1.77"	4	5	Box	On Request
L22L50A	1.96"	4	5	Box	On Request

### STEEL PADLOCKS, STANDARD KEY



### Prolok



ITEM	A in	B in	C in	D in	E in	THK in
P22S38B / P22S38	1.49	1.38	0.75	0.24	0.98	0.71
P22S45B	1.77	1.38	0.90	0.27	1.18	0.83
P22S50B / P22S50	1.96	1.57	1.02	0.31	1.34	0.91
P22L38B / P22L38	1.49	1.38	0.75	0.24	1.38	0.71
P22L45B / P22L45	1.77	1.38	0.90	0.27	1.69	0.83
P22L50B / P22L50	1.96	1.57	1.02	0.35	1.89	0.91



P22S50B P22S45B P22S38B



P22L50B P22L45B P22L38B P22L45



ITEM	WIDTH	LEVEL	PINS	PAKING	AVAILABLE
<b>Short shackle</b>					
P22S38B	1.49"	3	4	Blister	On Request
P22S45B	1.77"	3	5	Blister	On Request
P22S50B	1.96"	3	5	Blister	On Request
P22S38	1.49"	3	4	Box	On Request
P22S50	1.96"	3	5	Box	On Request
<b>Long shackle</b>					
P22L38B	1.49"	3	4	Blister	On Request
P22L45B	1.77"	3	5	Blister	On Request
P22L50B	1.96"	3	5	Blister	On Request
P22L38	1.49"	3	4	Box	On Request
P22L45	1.77"	3	5	Box	On Request
P22L50	1.96"	3	5	Box	On Request

### STANDARD KEY BRASS FINISH PADLOCK



These characteristics apply to:  
L22S63ELBB



L22S50ELBB L22S38ELBB L22S32ELBB



ITEM	A in	B in	C in	D in	E in	THK in
L22S32ELBB	1.25	1.18	0.62	0.19	0.70	0.55
L22S38ELBB	1.49	1.29	0.78	0.19	1.29	0.59
L22S50ELBB	1.96	1.57	1.02	0.27	1.49	0.78
L22S63ELBB	2.48	1.92	1.29	0.35	2.24	0.86

ITEM	WIDTH	LEVEL	PINS	PACKING	AVAILABLE
L22S32ELBB	1.25"	3	4	Blister	On Request
L22S38ELBB	1.49"	3	4	Blister	On Request
L22S50ELBB	1.96"	4	5	Blister	On Request
L22S63ELBB	2.48"	4	5	Blister	On Request

## LAMINATED PADLOCK

### WATERPROOF PADLOCK SET, STANDARD KEY

**4**



**4**  
PIECES



**4** PINS **3** STANDARD KEYS

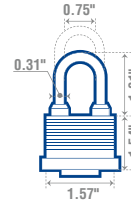

- Laminated body with plastic cover.
- Rubber cap to protect the cylinder and extend its service life.
- All padlocks open with the same key.



ITEM	J4CIL
WIDTH	1.57"
LEVEL	4
PINS	4
PACKING	Blister
	1
AVAILABLE	On Request

### WATERPROOF PADLOCK SET, STANDARD KEY

**4**



**2**  
PIECES



**4** PINS **3** STANDARD KEYS



- Laminated body with plastic cover.
- Rubber cap for cylinder protection, extending its service life.
- All padlocks open with the same key.



ITEM	18CA
WIDTH	1.57"
LEVEL	4
PINS	4
PACKING	Blister
	1
AVAILABLE	On Request

### WATERPROOF PADLOCKS, STANDARD KEY

**4**



C25L40

C25S40

**4** PINS **3** STANDARD KEYS



ITEM	A in	B in	C in	D in	E in	THK in
C25S40	1.57	1.54	0.75	0.31	1.02	1.26
C25L40	1.57	1.54	0.75	0.31	2.13	1.26



ITEM	WIDTH	LEVEL	PINS	PACKING		AVAILABLE
<b>Short shackle</b>						
C25S40	1.57"	4	4	Blister	1	On Request
<b>Long shackle</b>						
C25L40	1.57"	4	4	Blister	1	On Request

## LAMINATED PADLOCK

### LAMINATED PADLOCKS SET

COMERCIAL LINE



STANDARD SECURITY



SECURITY LEVEL

4

ANTI-SAW



ANTI-SHOCK



SAME COMBINATION



DOUBLE LOCK



4  
PIECES



5 PINS 3 STANDARD KEYS

- Reinforced laminated body.
- Solid brass cylinder.
- Hardened steel shackle for increased cut resistance.

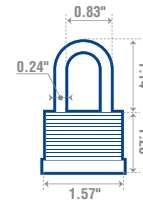

ITEM	J4CLA
WIDTH	1.57"
LEVEL	4
PINS	5
PACKING	Blister
📦	1
AVAILABLE	On Request

### LAMINATED PADLOCKS SET

COMERCIAL LINE



STANDARD SECURITY



SECURITY LEVEL

4

ANTI-SAW



ANTI-SHOCK



SAME COMBINATION



DOUBLE LOCK

2  
PIECES



16CA

2  
PIECES



17CA

5 PINS 3 STANDARD KEYS

- Reinforced laminated body.
- Solid brass cylinder.

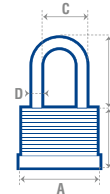

ITEM	A in	B in	C in	D in	E in	THK in
16CA	1.57	1.28	0.83	0.24	1.14	0.89
17CA	1.97	1.46	0.94	0.35	1.46	1.02

ITEM	16CA	17CA
WIDTH	1.57"	1.97"
LEVEL	4	4
PINS	5	5
PACKING	Blister	Blister
📦	1	1
AVAILABLE	On Request	On Request

### LAMINATED PADLOCK, STANDARD KEY

COMERCIAL LINE



STANDARD SECURITY



SECURITY LEVEL

3

ANTI-SAW



DOUBLE LOCK



C23S65

C23S50

C23S45

C23S40

C23S30

5 PINS 3 STANDARD KEYS

ITEM	WIDTH	LEVEL	PINS	PACKING	📦	AVAILABLE
C23S30	1.18"	3	3	Blister	1	On Request
C23S40	1.57"	3	3	Blister	1	On Request
C23S45	1.77"	4	5	Blister	1	On Request
C23S50	1.97"	4	4	Blister	1	On Request
C23S65	2.56"	4	6	Blister	1	On Request

### LAMINATED PADLOCK, STANDARD KEY

COMERCIAL LINE



STANDARD SECURITY



SECURITY LEVEL

3

ANTI-SAW



DOUBLE LOCK



L24S50EB

4 PINS 2 STANDARD KEYS

ITEM	A in	B in	C in	D in	E in	THK in
L24S50EB	1.97	1.46	0.94	0.35	1.06	1.14

ITEM	WIDTH	LEVEL	PINS	PAKING	📦	AVAILABLE
L24S50EB	1.97"	3	4	Blister	1	On Request

## COMBINATION PADLOCK

### TSA PADLOCKS

RESIDENTIAL LINE



SECURITY LEVEL

4

PROGRAMMABLE DISC

8 1 6  
9 2 7  
0 3 8



53CA



54CA

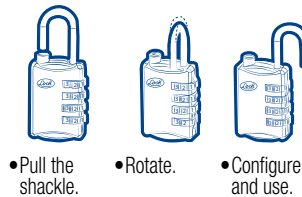

- Pull the shackle.
- Rotate.
- Configure and use.

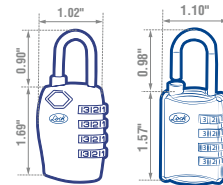

ITEM	COLOR	WIDTH	PACKING	QTY	AVAILABLE
53CA	Pink ●	0.79"	Blister	1	On Request
54CA	Black ●	1.18"	Blister	1	On Request

### COMBINATION PADLOCKS

RESIDENTIAL LINE



STANDARD SECURITY



SECURITY LEVEL

3

PROGRAMMABLE DISC

8 1 6  
9 2 7  
0 3 8



12CA

11CA

10CA

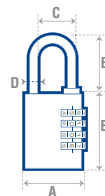

ITEM	A in	B in	C in	D in	E in	THK in
10CA	0.79	1.18	0.59	0.12	0.98	0.39
11CA	1.18	1.20	0.63	0.16	1.00	0.43
12CA	1.57	1.42	1.38	0.20	1.30	0.51

- Programmable dials.
- Ideal for lockers and luggage.

ITEM	WIDTH	DIALS QTY.	PACKING	QTY	AVAILABLE
10CA	0.79"	3	Blister	1	On Request
11CA	1.18"	3	Blister	1	On Request
12CA	1.57"	4	Blister	1	On Request

### COMBINATION SUITCASE PADLOCK

RESIDENTIAL LINE



STANDARD SECURITY



SECURITY LEVEL

2

PROGRAMMABLE DISC

8 1 6  
9 2 7  
0 3 8



L21M20PT



L21M36

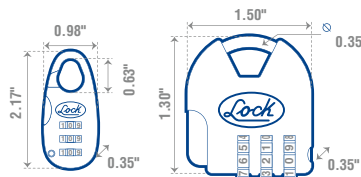

- Programmable dials.
- Ideal for lockers and luggage.

ITEM	WIDTH	LEVEL	PACKING	QTY	AVAILABLE
L21M20PT	0.98"	2	Blister	1	On Request
L21M36	1.50"	2	Blister	1	On Request

### DISC COMBINATION PADLOCK

RESIDENTIAL LINE



STANDARD SECURITY



SECURITY LEVEL

3

COMBINATION DISC



L26S50NGB



L26S50RJB



L26S50AMB



- Programmable dials.
- Ideal for lockers and luggage.

ITEM	COLOR	WIDTH	LEVEL	PACKING	QTY	AVAILABLE
L26S50NGB	Black ●	1.97"	3	Blister	1	On Request
L26S50RJB	Red ●	1.97"	3	Blister	1	On Request
L26S50AMB	Yellow ●	1.97"	3	Blister	1	On Request

## COMBINATION PADLOCK

### DIGITAL PADLOCK

RESIDENTIAL LINE STANDARD SECURITY SECURITY LEVEL **3** DIGITAL COMBINATION



C27C40



C27R35

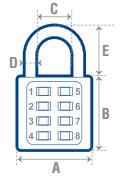

ITEM	A in	B in	C in	D in	E in	THK in
C27C35	1.38	1.50	0.75	0.20	0.75	0.63
C27C40	1.57	1.69	0.87	0.24	0.91	0.63
C27R35	1.38	1.50	0.75	0.20	0.75	0.63
C27R40	1.57	1.69	0.87	0.24	1.18	0.63



ITEM	FINISH	WIDTH	LEVEL	PACKING	AVAILABLE
C27C35	Polished chrome	1.38"	3	Blister	1
C27C40	Polished chrome	1.57"	3	Blister	1
C27R35	Red	1.38"	3	Blister	1
C27R40	Red	1.57"	3	Blister	1

## ROLL DOOR PADLOCKS

### ROLL DOOR PADLOCK SET, STANDAR KEY

COMERCIAL LINE HIGH SECURITY SECURITY LEVEL **7** ANTI-PRY ANTI-SAW ANTI-SHOCK SAME COMBINATION



**2**  
PIECES

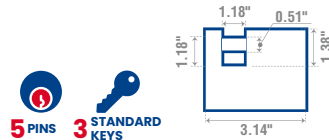

**5** PINS **3** STANDARD KEYS



ITEM	J2CC
WIDTH	3.14"
LEVEL	7
FINISH	Satin nickel
PINS	5
AVAILABLE	On Request

### ROLL DOOR PADLOCK SET, STANDAR KEY

COMERCIAL LINE HIGH SECURITY SECURITY LEVEL **7** ANTI-PRY ANTI-SAW ANTI-SHOCK SAME COMBINATION



**2**  
PIECES

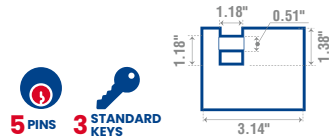

**5** PINS **3** STANDARD KEYS



ITEM	J2CCL
WIDTH	3.14"
LEVEL	7
FINISH	Polished brass
PINS	5
AVAILABLE	On Request

### ROLL DOOR PADLOCK, DIMPLE KEY

COMERCIAL LINE HIGH SECURITY SECURITY LEVEL **10** ANTI-PRY ANTI-SAW ANTI-SHOCK

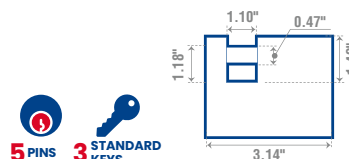

**5** PINS **3** STANDARD KEYS



ITEM	WIDTH	LEVEL	FINISH	PINS	AVAILABLE
L22C80QCBB	3.14"	10	Satin nickel	5	1

## ROLL DOOR PADLOCKS

### ROLL DOOR PADLOCKS, TETRA KEY



L22C80TCSB L22C70TCSB



L22C80TLBB L22C70TLBB

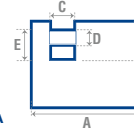

ITEM	A in	B in	C in	D in	E in	THK in
L22C70TCSB	2.75	1.18	0.90	0.47	1.02	0.78
L22C80TCSB	3.14	1.37	1.14	0.51	1.02	0.78
L22C70TLBB	2.75	1.18	0.90	0.47	1.02	0.78
L22C80TLBB	3.14	1.37	1.14	0.51	1.02	0.78



ITEM	WIDTH	LEVEL	AVAILABLE
<b>Satin chrome</b>			
L22C70TCSB	2.75"	8	On Request
L22C80TCSB	3.14"	8	On Request
<b>Polished brass</b>			
L22C70TLBB	2.75"	6	On Request
L22C80TLBB	3.14"	7	On Request

### ROLL DOOR PADLOCK, STANDARD KEY

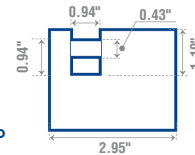

ITEM	WIDTH	LEVEL	PINS	AVAILABLE
L20C75EB	2.95"	6	5	On Request

### ROLL DOOR STEEL PADLOCK, STANDAR KEY



L22C80ECSB L22C70ECSB



L22C80ELBB L22C70ELBB

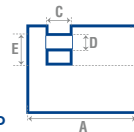

ITEM	A in	B in	C in	D in	E in	THK in
L22C70ECSB	2.75	1.18	0.78	0.47	0.98	0.78
L22C80ECSB	3.14	1.37	1.18	0.51	1.18	0.78
L22C70ELBB	2.75	1.18	0.78	0.47	0.98	0.78
L22C80ELBB	3.14	1.37	1.18	0.51	1.18	0.78



ITEM	WIDTH	LEVEL	AVAILABLE
<b>Satin chrome</b>			
L22C70ECSB	2.75"	6	On Request
L22C80ECSB	3.14"	7	On Request
<b>Polished brass</b>			
L22C70ELBB	2.75"	6	On Request
L22C80ELBB	3.14"	7	On Request

## ROLL DOOR PADLOCKS

### STEEL PADLOCK WITH PVC COVER FOR ROLL-UP DOORS, STANDARD KEY

COMERCIAL LINE STANDARD SECURITY SECURITY LEVEL 6 SECURITY LEVEL 7 ANTI-PRY ANTI-SAW ANTI-SHOCK ANTI-PICK

**Prolok**  
  
**NEW**



62CA

**5 PINS** **3 STANDARD KEYS**

ITEM	A in	B in	C in	D in	E in	THK in
62CA	2.76	1.26	0.87	0.39	1.18	0.94
63CA	2.76	1.26	0.87	0.39	1.18	0.94

- Steel body with PVC cover.
- Safety mechanism prevents the key from being removed while the padlock is open.

ITEM	WIDTH	PINS	KEY	AVAILABLE
62CA	2.95"	5	1	On Request
63CA	3.14"	5	1	On Request

### ROLL-UP DOOR PADLOCKS, STANDARD KEY

COMERCIAL LINE STANDARD SECURITY SECURITY LEVEL 4 ANTI-PRY ANTI-SAW ANTI-SHOCK

**Prolok**  
  
**NEW**



P19C80

P19C70

**5 PINS** **2 STANDARD KEYS**

ITEM	A in	B in	C in	D in	E in	THK in
P19C70	2.76	1.26	0.87	0.43	1.14	0.91
P19C80	3.15	1.38	1.10	0.43	1.18	0.91

- Iron body.

ITEM	WIDTH	PINS	KEY	AVAILABLE
P19C70	2.95"	5	1	On Request
P19C80	3.14"	5	1	On Request

## CANDADOS DE CABLE

### CABLE LOCK WITH KEY

COMERCIAL LINE STANDARD SECURITY SECURITY LEVEL 3 BRAIDED STEEL CABLE



10CN

- 3 STANDARD KEYS**
- PVC cover.
  - Keys with blue LED light.
  - Single cylinder.
  - Includes lock holder (except model 13CN).

ITEM	DIAMETER	LENGHT	PACKING	KEY	AVAILABLE
10CN	0.39"	39.37"	Blister	1	On Request
11CN	0.47"	47.24"	Blister	1	On Request
12CN	0.59"	39.37"	Blister	1	On Request
13CN	0.71"	47.24"	Blister	1	On Request

### COMBINATION WIRE LOCK

COMERCIAL LINE STANDARD SECURITY SECURITY LEVEL 3 BRAIDED STEEL CABLE PROGRAMABLE DISC



14CN

- PVC cover.
- Cylinder with 4-digit combination.
- Includes lock holder.

ITEM	DIAMETER	LENGHT	PACKING	KEY	AVAILABLE
14CN	0.31"	39.37"	Blister	1	On Request
15CN	0.31"	47.24"	Blister	1	On Request

## MOTORCYCLE LOCKS

### DISC BRAKE PADLOCK

COMERCIAL LINE
STANDARD SECURITY
SECURITY LEVEL
3
ANTI-PRY
ANTI-SAW
ANTI-SHOCK

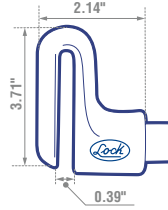

2 TUBULAR KEYS

- Metal cover and steel hook.
- Designed to secure vehicles with disc brakes such as motorcycles and scooters.



ITEM	BOLT DIAMETER	PACKING	AVAILABILITY
21CA	25/64"	Blister	1 ✓

### DISC BREAK PADLOCK

COMERCIAL LINE
HIGH SECURITY
SECURITY LEVEL
6
110 dB
BATTERIES INCLUDED

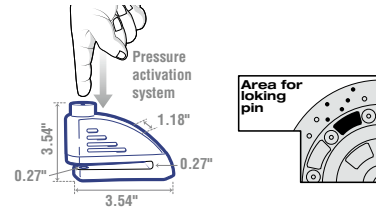

5 PINS 5 TUBULAR KEYS

- Zinc body with chrome finish.
- Disc-activated locking mechanism.
- Steel pin.
- Cylinder with solid brass body.
- Alarm activates upon detecting vibrations or movement.



ITEM	LOCK TYPE	BODY	LEVEL	PACKING	AVAILABILITY
CASOD	Disco	Chrome-zinc	6	Blister	1 ✓

## CANDADO TIPO U

### U-LOCK PADLOCK

HIGH SECURITY
SECURITY LEVEL
6
ANTI-SAW
ANTI-SHOCK
DOUBLE LOCK



NEW

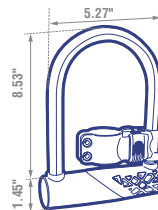

2 DISC KEYS

- Anti-drilling disc cylinder.
- Mounting bracket included.
- Ideal for bicycles, motorcycles, or gates.



ITEM	WIDTH	LEVEL	FINISH	PACKING	AVAILABILITY
58CA	10"	6	Black	Sleeve	6 On Request



## RESIDENTIAL LOCKS



### Function

This key locks or releases the latch with the following advantages:

#### LOCKED POSITION

**Locked position:** Prevents access to the indoor area by immobilizing the latch and blocking the operation of the security bolt.

#### Free position:

#### FREE POSITION

By turning the cylinder with the key at a 35° angle, the latch is released, allowing it to function as a conventional handle. Thanks to its dual function, it

provides greater security for access through a main door.



### MESSINA HANDLESETS

ARCHITECTURAL LINE



HIGH SECURITY



400 000 LIFE CYCLES



INCLUDES INSTALLATION ACCESSORIES



STAINLESS STEEL

ProForza



NEW

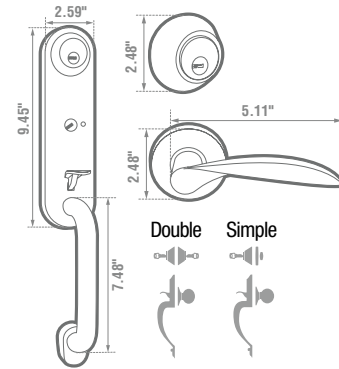

Note: Verify the correct model according to the door opening direction.



PF38062-3000-32DLH  
• Solid stainless steel handle.



5 PRECISION PINS



5 DIMPLE KEYS

ANSI 3 GRADE

- 65 mm rose, the only one on the market compatible for replacing conventional locks.
- Solid stainless steel handle.
- Reversible latch (60 mm).
- Auto-adjusting system for door thickness.
- Suitable for doors from 35 mm to 45 mm thick.



ITEM	FUNCTION		PACKING	📦	AVAILABLE
PF38062-3000-32DLHV	Double	Left	Visual	6	✓
PF38062-3000-32DRHV	Double	Right	Visual	6	✓
PF38062-3000-32DLH	Double	Left	Visual	6	✓
PF38062-3000-32DRH	Double	Right	Box	1	✓



### Function

#### DOUBLE FUNCTION

The trigger or knob actuates the latch. The deadbolt latch is actuated by turning the key on the outside or inside. The outer trigger or inner knob actuates

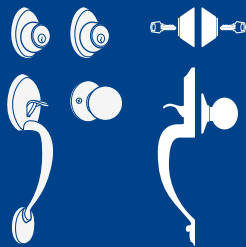

#### SIMPLE FUNCTION

the trigger latch. The latch latch is actuated by turning the key on the outside or the simple mechanism on the inside.

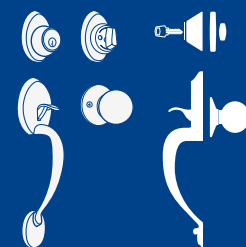

### RECTANGULAR DOOR HANDLE SET

RESIDENTIAL LINE



HIGH SECURITY



400 000 LIFE CYCLES



INCLUDES INSTALLATION ACCESSORIES



STAINLESS STEEL

Lock



NEW

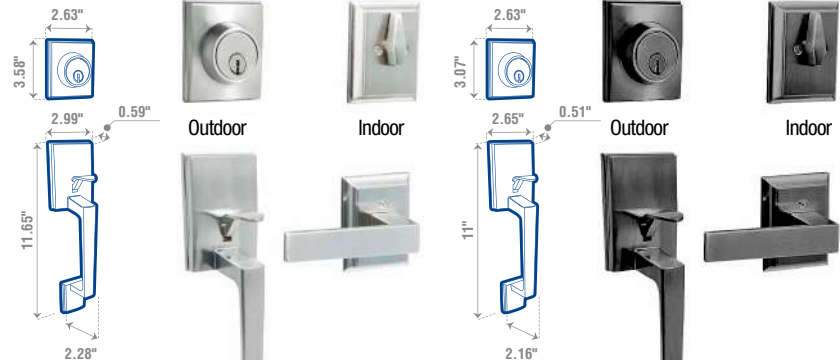

5 PINS



2 STANDARD KEYS

ANSI 3 GRADE

10GA



5 PINS



3 DIMPLE KEYS

ANSI 3 GRADE

16GA

- Made of high-pressure die-cast Zamak.
- Solid handle and latch.
- High-pressure die-cast chrome-plated zinc latch bolt.
- Solid brass 5-pin cylinder.
- For doors from 35 to 45 mm thick.

ITEM	11GA	10GA
FUNCTION	Double	Simple
FINISH	Satin nickel	
PACKING	Visual	Visual
📦	1	1
AVAILABLE	On Request	On Request

ITEM	15GA	16GA
FUNCTION	Double	Simple
FINISH	Matte black	
PACKING	Visual	Visual
📦	1	1
AVAILABLE	On Request	On Request



## RESIDENTIAL SETS

### RESIDENTIAL SETS

RESIDENTIAL LINE HIGH SECURITY 200 000 LIFE CYCLES INCLUDES INSTALLATION ACCESSORIES

**Prolok**

**NEW**

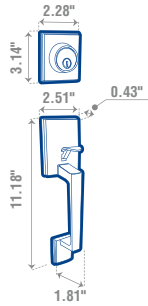

PGR60NV

**5 PRECISION PINS** **3 DIMPLE KEYS**

- Manufactured in high-pressure Zamak.
- Solid handle and latch.
- High-pressure injected chrome-plated zinc latch bolt.
- Solid brass 5-pin cylinder.
- For doors from 35 to 45 mm thick.

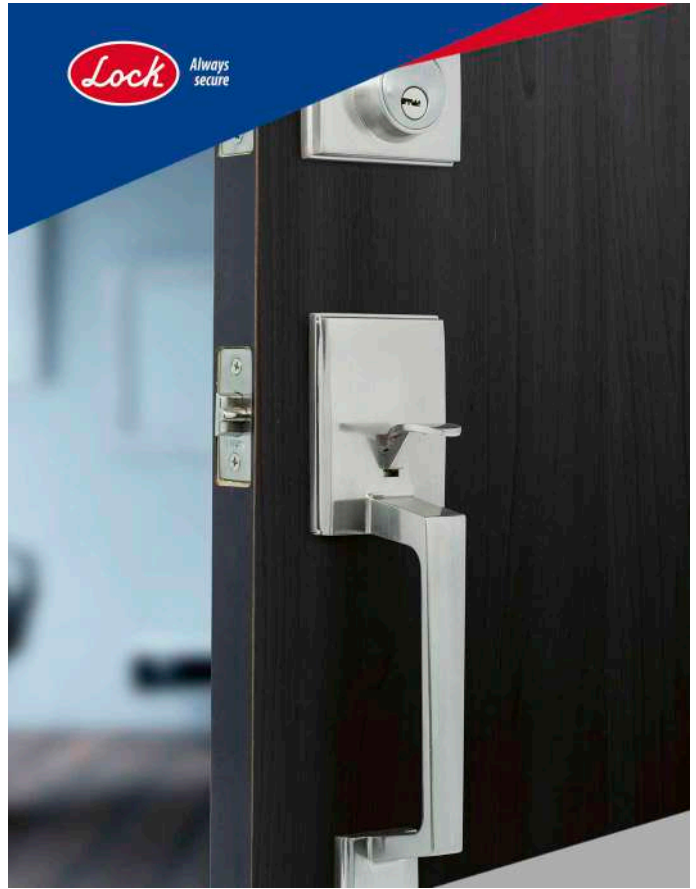

ITEM	PGR62NV	PGR60NV
FUNCTION	Double	Simple
FINISH	Satin nickel	
PACKING	Visual	Visual
	1	1
AVAILABLE	On Request	On Request

### OVAL DOOR HANDLE SET

RESIDENTIAL LINE HIGH SECURITY 400 000 LIFE CYCLES INCLUDES INSTALLATION ACCESSORIES

**Lock** Always secure



**NEW**

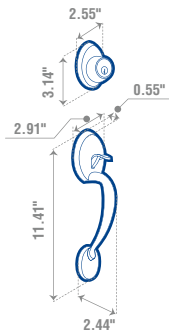

12GA

13GA

14GA

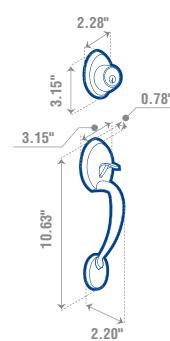

17GA

**5 PINS** **3 STANDARD KEYS** **ANSI 3 GRADE**

- Manufactured in high-pressure Zamak.
- Solid handle and latch.
- High-pressure injected chrome-plated zinc latch bolt.
- Solid brass 5-pin cylinder.
- For doors from 35 to 45 mm thick.

**5 PINS** **3 STANDARD KEYS** **ANSI 3 GRADE**



ITEM	12GA
FUNCTION	Simple
FINISH	Satin nickel
PACKING	Visual
	1
AVAILABLE	On Request

ITEM	13GA
FUNCTION	Simple
FINISH	Polished brass
PACKING	Visual
	1
AVAILABLE	On Request

ITEM	14GA
FUNCTION	Simple
FINISH	Antique brass
PACKING	Visual
	1
AVAILABLE	On Request

ITEM	17GA
FUNCTION	Simple
FINISH	Matte black
PACKING	Visual
	1
AVAILABLE	On Request

## LEVER HANDLE LOCKS WITH MORTISE MECHANISM

### MESSINA HANDLES

ARCHITECTURAL LINE HIGH SECURITY 400 000 LIFE CYCLES

INCLUDES INSTALLATION ACCESSORIES STAINLESS STEEL

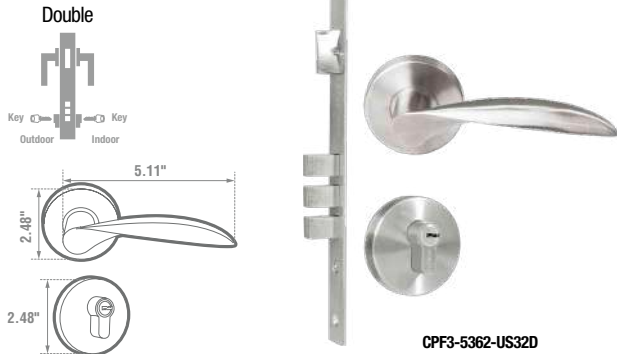

CPF3-5362-US32D

5 PRECISION PINS 5 DIMPLE KEYS ANS13 GRADE

- 65 mm rosette the only one on the market designed to replace conventional locks.
- Solid stainless-steel handle.
- 85 mm distance between handle and cylinder.
- Reversible latch bolt, 60 mm.
- For doors from 35 mm to 45 mm thick.
- 2-step, 3-bolt deadlock for maximum security.



ITEM	FUNCTION	PACKING	AVAILABILITY
CPF3-5362-US32DV	Double	Visual	1 ✓
CPF3-5362-US32D	Double	Box	1 ✓

### CALABRIA LEVER HANDLE

ARCHITECTURAL LINE HIGH SECURITY 400 000 LIFE CYCLES

INCLUDES INSTALLATION ACCESSORIES STAINLESS STEEL

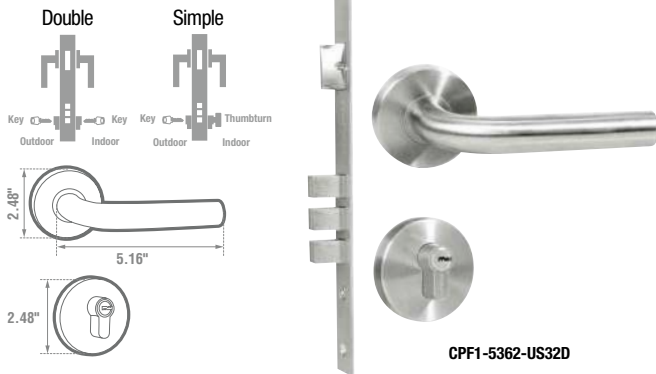

CPF1-5362-US32D

• Solid stainless steel handle

5 PRECISION PINS 5 DIMPLE KEYS ANS13 GRADE

- 65 mm rosette unique in the market to replace conventional locks.
- 85 mm distance between handle and cylinder.
- For doors from 35 to 45 mm thick.
- Reversible latch: 60 mm.
- 3-bolt deadlock with 2-step mechanism for maximum security.



ITEM	FUNCTION	PACKING	AVAILABILITY
CPF1-5362-US32D	Double	Box	1 ✓
CPF1-5360-US32D	Simple	Box	1 ✓

### TOSCANA HANDLE

ARCHITECTURAL LINE HIGH SECURITY 400 000 LIFE CYCLES

INCLUDES INSTALLATION ACCESSORIES STAINLESS STEEL



CPF2-5362-US32D

• Solid stainless steel handle

5 PRECISION PINS 5 DIMPLE KEYS ANS13 GRADE

- 65 mm rosette the only one on the market designed to replace conventional locks.
- Solid stainless-steel handle.
- 85 mm distance between handle and cylinder.
- Reversible latch bolt, 60 mm.
- For doors from 35 mm to 45 mm thick.
- 2-step, 3-bolt deadlock for maximum security.



ITEM	FUNCTION	PACKING	AVAILABILITY
CPF2-5362-US32D	Double	Box	1 ✓

### DISPLAY FOR COUNTER WITH MESSINA MORTISE LOCK MECHANISM

1 PIECE



ITEM	DESCRIPTION	QUANTITY
CPF3-5362-US32D	Double Messina mortise entry lock	1
LITME	Display stand for mortise handle	1

BOX

ITEM	DIMENSIONS	AVAILABILITY
LEMD	7.9" x 14.2" x 5.9"	1 ✓

### DISPLAY FOR COUNTER WITH TOSCANA MORTISE LOCK MECHANISM

1 PIECE



ITEM	DESCRIPTION	QUANTITY
CPF2-5362-US32D	Double Toscana mortise entry lock	1
LITME	Display stand for mortise handles	1

BOX

ITEM	DIMENSIONS	AVAILABILITY
LETD	7.9" x 14.2" x 5.9"	1 ✓

## LEVER LOCKS

### MESSINA STAINLESS STEEL COMBO

ARCHITECTURAL LINE HIGH SECURITY 400 000 LIFE CYCLES

INCLUDES INSTALLATION ACCESSORIES STAINLESS STEEL



• Solid stainless steel handle

5 PRECISION PINS 5 DIMPLE KEYS ANSI 3 GRADE

- 65 mm (2.56") rosette unique in the market to replace conventional locks.
- Self-adjusting system to door thickness.
- For doors from 35 mm to 45 mm (1.38" – 1.77") thick.
- Reversible latch: 60 mm (2.36").
- Anti-pick bolt.



ITEM	FUNCTION	PACKING	QTY	AVAILABLE
CPF3-1060-US32D	Simple	Box	1	✓

### MESSINA STAINLESS STEEL LEVER HANDLE

ARCHITECTURAL LINE HIGH SECURITY 400 000 LIFE CYCLES

INCLUDES INSTALLATION ACCESSORIES STAINLESS STEEL ADA COMPLIANT



Privacy button

CPF3-10S-US32D

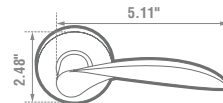

ANSI 3 GRADE

- 65 mm (2.56") rosette unique in the market to replace conventional locks.
- Self-adjusting system to door thickness.
- For doors from 35 to 45 mm (1.38" – 1.77") thick.
- Reversible latch: 60 mm (2.36").



ITEM	FUNCTION	PACKING	QTY	AVAILABLE
CPF3-10S-US32D	Passage	Box	1	✓

## TUBULAR LEVER LOCKS

### CALABRIA STAINLESS STEEL LEVER HANDLES

ARCHITECTURAL LINE HIGH SECURITY 400 000 LIFE CYCLES

INCLUDES INSTALLATION ACCESSORIES STAINLESS STEEL ADA COMPLIANT



Botón privacidad

CPF1-10S-US32D

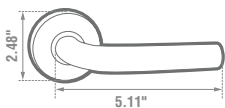

ANSI 3 GRADE

- 65 mm (2.56") rosette unique in the market to replace conventional locks.
- Self-adjusting system to door thickness.
- For doors from 35 mm to 45 mm (1.38" – 1.77") thick.
- Reversible latch: 60 mm (2.36").



ITEM	FUNCTION	PACKING	QTY	AVAILABLE
CPF1-10-US32DV	Passage	Visual	1	✓
CPF1-10S-US32D	Passage	Box	1	✓

### DISPLAY FOR COUNTER WITH SINGLE CALABRIA COMBO

1 PIECE



Content	QTY
CPF1-1060-US32D Single Calabria entry lock	1
LTMS Display stand for main entrance handles	1

BOX

ITEM	DIMENSIONS	QTY	AVAILABLE
LECS	7.9" x 14.2" x 5.9"	1	✓



## TUBULAR LEVER LOCKS

### Function

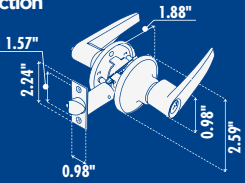

### Features:

Tubular mechanism for easy installation. With adjustable handle to 2-3/8" to 2-3/4" with safety device. For use on doors from 1-3/8" to 1-3/4" thick.

Tropicalized steel tubular body.

Metal front.

High pressure injected chrome zinc latch head.

Laminated shields made of brass or stainless steel.

Ergonomic, long lasting handle made of high-pressure Zamac.

Adjustable reversible latch with 2-3/8" to 2-3/4" backset (60 mm to 70 mm).

### FUNCTION

#### KEY-TURN BUTTON BEDROOM



### Features:

- Latch with security device.
- External key.
- Inner privacy.

### FUNCTION

#### SLOT-TURN BUTTON BATHROOM



### Features:

- Standard latch.
- Outdoor Emergency.
- Device Indoor.
- Privacy Handle.

## CURVE HANDLES

RESIDENTIAL LINE



STANDARD SECURITY



400 000 LIFE CYCLES



INCLUDES INSTALLATION ACCESSORIES



16MA



18MA



20MA



ANSI 3 GRADE

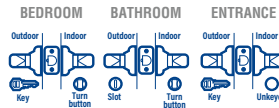
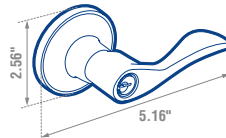

• For use on doors from 35 mm to 45 mm (1.38" to 1.77") thick.

ITEM	16MA*	17MA
FUNCTION	Bedroom Entrance Bathroom	Bathroom
FINISH	Satin nickel	
PACKING	Blister	Blister
	1	1
AVAILABLE	On Request	On Request

ITEM	18MA*	19MA
FUNCTION	Bedroom Entrance Bathroom	Bathroom
FINISH	Polished brass	
PACKING	Blister	Blister
	1	1
AVAILABLE	On Request	On Request

ITEM	20MA*	21MA
FUNCTION	Bedroom Entrance Bathroom	Bathroom
FINISH	Antique brass	
PACKING	Blister	Blister
	1	1
AVAILABLE	On Request	On Request

## FLAT HANDLES

RESIDENTIAL LINE



STANDARD SECURITY



400 000 LIFE CYCLES



INCLUDES INSTALLATION ACCESSORIES

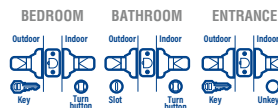
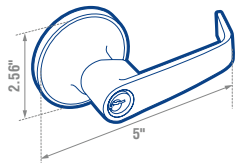

ANSI 3 GRADE

• For use on doors from 35 mm to 45 mm (1.38" to 1.77") thick

ITEM	22MA*	23MA
FUNCTION	Bedroom Entrance Bathroom	Bathroom
FINISH	Satin nickel	
PACKING	Blister	Blister
	1	1
AVAILABLE	On Request	On Request

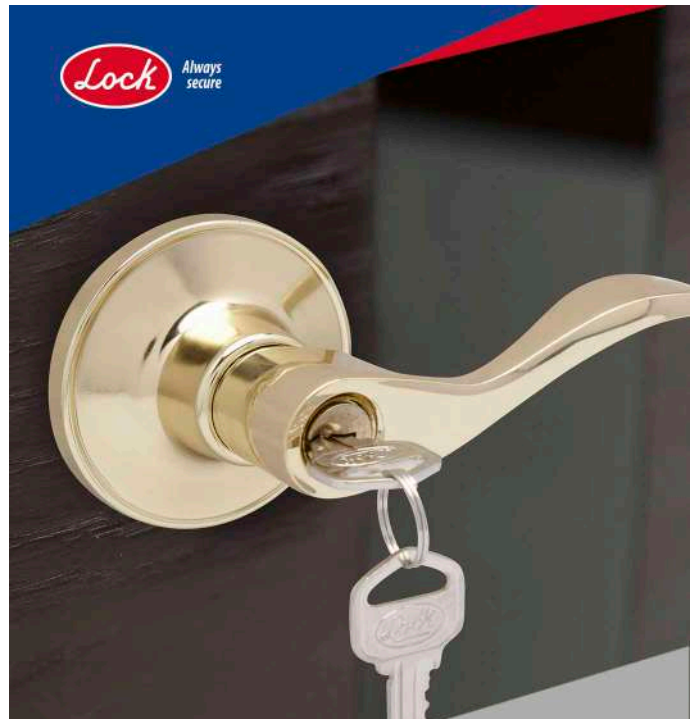

LOCKSMITH

## TUBULAR LEVER LOCKS

### STRAIGHT HANDLES

RESIDENTIAL LINE STANDARD SECURITY 400 000 LIFE CYCLES INCLUDES INSTALLATION ACCESSORIES



10MA



12MA



14MA



25MA

5 PINS 2 STANDARD KEYS **ANSI 3** GRADE

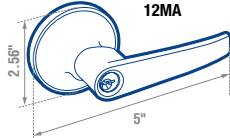

•For use on doors from 35 mm to 45 mm (1.38" to 1.77") thick.

ITEM	10MA*	11MA
FUNCTION	Bedroom Entrance Bathroom	
FINISH	Satin nickel	
PACKING	Blister	Blister
	1	1
AVAILABLE	On Request	On Request

ITEM	12MA*	13MA
FUNCTION	Bedroom Entrance Bathroom	
FINISH	Polished brass	
PACKING	Blister	Blister
	1	1
AVAILABLE	On Request	On Request

ITEM	14MA*	15MA
FUNCTION	Bedroom Entrance Bathroom	
FINISH	Antique brass	
PACKING	Blister	Blister
	1	1
AVAILABLE	On Request	On Request

ITEM	25MA*	26MA
FUNCTION	Bedroom Bathroom	
FINISH	Black	
PACKING	Blister	Blister
	1	1
AVAILABLE		On Request

## CYLINDRICAL LEVER HANDLES

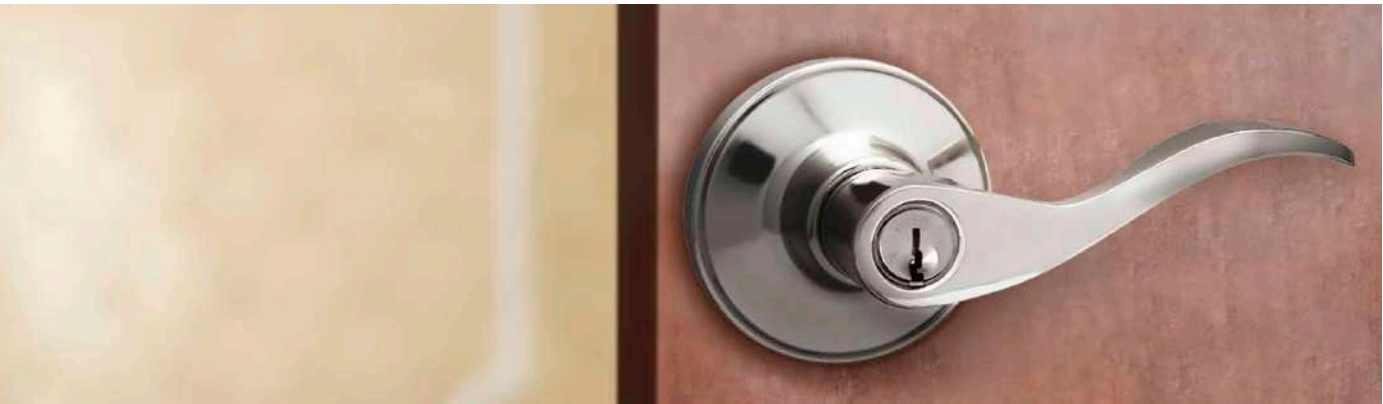

### CYLINDRICAL HANDLES VERMONT

COMMERCIAL LINE HIGH SECURITY 500 000 LIFE CYCLES INCLUDES INSTALLATION ACCESSORIES

ANTI-PICK ANTI-PRY STAINLESS STEEL LISTED ADA COMPLIANT

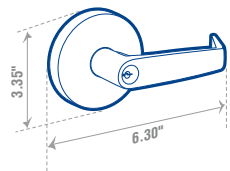

LR062B

6 PINS 2 STANDARD KEYS **ANSI 2** GRADE



•For use on doors from 35 mm to 45 mm (1.38" to 1.77") thick.

ITEM	LR062B*	LR000B*	LR030B
FUNCTION	Entrance	Bedroom	Bathroom
FINISH	Stainless Steel		
PACKING	Blister	Blister	Blister
	1	1	1
AVAILABLE	On Request	On Request	On Request

### FLAT CYLINDRICAL LEVER HANDLES - SATIN NICKEL

RESIDENTIAL LINE STANDARD SECURITY 200 000 LIFE CYCLES INCLUDES INSTALLATION ACCESSORIES



NEW

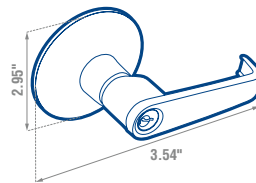

14MAP

5 PINS 3 STANDARD KEYS **ANSI 3** GRADE



•For use on doors from 35 mm to 45 mm (1.38" to 1.77") thick.

ITEM	14MAP*	15MAP
FUNCTION	Bedroom	Bathroom
FINISH	Satin nickel	
PACKING	Blister	Blister
	1	1
AVAILABLE	On Request	On Request

## CYLINDRICAL LEVER HANDLES

### CURVED CYLINDRICAL LEVER HANDLES - SATIN NICKEL

RESIDENTIAL LINE STANDARD SECURITY 200 000 LIFE CYCLES INCLUDES INSTALLATION ACCESSORIES

NEW



5 PINS 3 STANDARD KEYS ANSI 3 GRADE

10MAP

• For use on doors from 35 mm to 45 mm (1.38" to 1.77") thick.

ITEM	10MAP*	
FUNCTION	Bedroom	Entrance
FINISH	Satin nickel	
PACKING	Blister	Blister
	1	1
AVAILABLE	On Request	On Request

### STRAIGHT CYLINDRICAL LEVER HANDLES - SATIN NICKEL

RESIDENTIAL LINE STANDARD SECURITY 200 000 LIFE CYCLES INCLUDES INSTALLATION ACCESSORIES

NEW



5 PINS 3 STANDARD KEYS ANSI 3 GRADE

12MAP

• For use on doors from 35 mm to 45 mm (1.38" to 1.77") thick.

ITEM	12MAP*	
FUNCTION	Bedroom	Entrance
FINISH	Satin nickel	
PACKING	Blister	Blister
	1	1
AVAILABLE	On Request	On Request

## DEADBOLTS

### RESIDENTIAL DEADBOLTS

RESIDENTIAL LINE STANDARD SECURITY 400 000 LIFE CYCLES INCLUDES INSTALLATION ACCESSORIES



STAINLESS STEEL



13CE



17CE



15CE

5 PINS 2 STANDARD KEYS ANSI 3 GRADE

- Cylinder made of brass with 5 pins.
- Zinc die-cast latch head, high-pressure injection molded and chrome plated.
- Adjustable latch: 60 mm to 70 mm (2.36" to 2.76").
- For metal or wooden swing doors from 35 mm to 45 mm (1.38" to 1.77") thick.



ITEM	12CE	13CE
FUNCTION	Double	Simple
FINISH	Stainless Steel	
PACKING	Blister	Blister
	1	1
AVAILABLE	On Request	On Request

ITEM	16CE	17CE
FUNCTION	Double	Simple
FINISH	Polished brass	
PACKING	Blister	Blister
	1	1
AVAILABLE	On Request	On Request

ITEM	14CE	15CE
FUNCTION	Double	Simple
FINISH	Antique brass	
PACKING	Blister	Blister
	1	1
AVAILABLE	On Request	On Request

### RESIDENTIAL DEADBOLT

RESIDENTIAL LINE STANDARD SECURITY 200 000 LIFE CYCLES INCLUDES INSTALLATION ACCESSORIES STAINLESS STEEL

Prolok

NEW

5 PINS 2 STANDARD KEYS ANSI 3 GRADE

- Cylinder made of brass with 5 pins.
- Zinc die-cast latch head, high-pressure injection molded and chrome plated.
- Adjustable latch: 60 mm to 70 mm (2.36" to 2.76").
- For metal or wooden swing doors from 35 mm to 45 mm (1.38" to 1.77") thick



ITEM	MY-660-US32D
FUNCTION	Simple
FINISH	Stainless Steel
PACKING	Box
	1
AVAILABLE	✓



MY-660-US32D

## KNOB LOCKS



### Function

#### FUNCTION DOUBLE

**Description:**  
The combo includes a tubular bedroom knob lock and a double deadbolt. They both have the same key combination.

- Features:**
- Latch with extra security mechanism.
  - Latch whit anti-hack system.

#### COMBO DOUBLE DEADBOLT



#### Features:

- Outdoor key (both).
- Indoor key (deadbolt).
- Privacy indoor knob.

#### FUNCTION SIMPLE

**Description:**  
The combo includes a tubular chamber knob lock and a single latch. They both have the same key combination.

- Features:**
- Latch with extra security mechanism.
  - Latch whit anti-hack system.

#### COMBO SIMPLE DEADBOLT



#### Features:

- Outdoor key (both).
- Indoor turn button (both).

### TUBULAR BALL COMBOS

RESIDENTIAL LINE



STANDARD SECURITY



400 000 LIFE CYCLES



INCLUDES INSTALLATION ACCESSORIES



STAINLESS STEEL

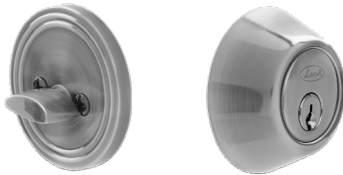

Indoor

Outdoor



11CB



Indoor

Outdoor



15CB



Indoor

Outdoor



13CB

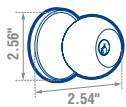

5 PINS  
4 STANDARD KEYS  
ANSI 3 GRADE

- Brass cylinders.
- Same key combination for knob and deadbolt.

ITEM	10CB	11CB
FUNCTION	Double	Simple
FINISH	Stainless Steel	
PACKING	Blister	Blister
☑	1	1
AVAILABLE	On Request	On Request

ITEM	14CB	15CB
FUNCTION	Double	Simple
FINISH	Polished brass	
PACKING	Blister	Blister
☑	1	1
AVAILABLE	On Request	On Request

ITEM	12CB	13CB
FUNCTION	Double	Simple
FINISH	Antique brass	
PACKING	Blister	Blister
☑	1	1
AVAILABLE	On Request	On Request





## DEADBOLT AND KNOB COMBOS

### DEADBOLT AND KNOB COMBOS

RESIDENTIAL LINE STANDARD SECURITY 200 000 LIFE CYCLES INCLUDES INSTALLATION ACCESSORIES STAINLESS STEEL

**Prolok**  
  
**NEW**



**10CBP**



**11CBP**

5 PINS 2 STANDARD KEYS **ANSI 3 GRADE**

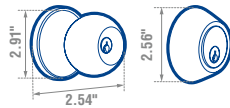

• For use on doors from 35 mm to 45 mm (1.38" to 1.77") thick.

ITEM	10CBP
FUNCTION	Double
FINISH	Stainless Steel
PACKING	Blisters
	1
AVAILABLE	On Request

ITEM	11CBP
FUNCTION	Simple
FINISH	Stainless Steel
PACKING	Blisters
	1
AVAILABLE	On Request

### TUBULAR BALL COMBO

RESIDENTIAL LINE STANDARD SECURITY 200 000 LIFE CYCLES INCLUDES INSTALLATION ACCESSORIES

**Prolok**  
  
**NEW**

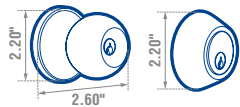

5 PINS 3 STANDARD KEYS **ANSI 3 GRADE**

- Chrome-plated zinc latch with hardened steel core.
- For use on doors from 35 mm to 45 mm (1.38" to 1.77") thick.
- ANSI/BHMA A 156.2 compliant.



ITEM	MY-CT5362BOLA-US5
FUNCTION	Double
FINISH	Antique brass
PACKING	Box
	1
AVAILABLE	On Request



LOCKSMITH

## KNOB LOCKS



### Function

**FUNCTION**  
**KEY - UNKEYED**  
**MAIN ENTRANCE**

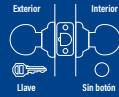

#### Features:

- Latch with security device.
- External key.
- Anti-panic system.

**FUNCTION**  
**KEY - TURN**  
**BUTTON**  
**BEDROOM**

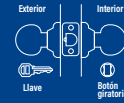

#### Features:

- Latch with security device.
- External key.
- Anti-panic system.
- Inner privacy.

**FUNCTION**  
**SLOT - TURN**  
**BUTTON**  
**BATHROOM**

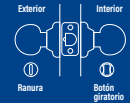

#### Features:

- Standard latch.
- Inner privacy.

### Tubular flat knob

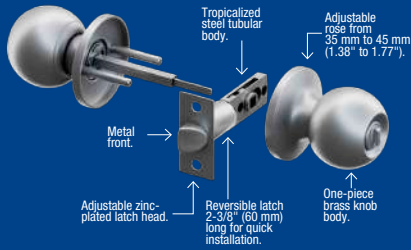

#### Dimensions

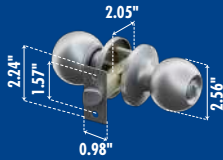

### Tubular ball knob

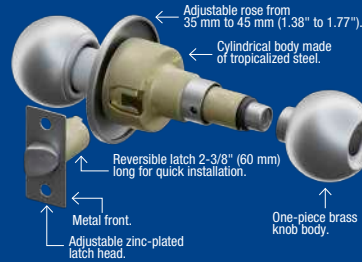

#### Dimensions

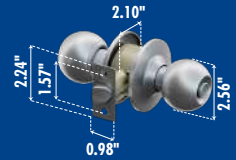

### TUBULAR FLAT KNOB

RESIDENTIAL LINE STANDARD SECURITY 400 000 LIFE CYCLES INCLUDES INSTALLATION ACCESSORIES



STAINLESS STEEL



19PO



23PO



22PO

5 PINS 2 STANDARD KEYS **ANSI 3 GRADE**

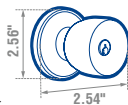

\*For use on doors from 35 mm to 45 mm (1.38" to 1.77") thick.

ITEM	19PO*	20PO
FUNCTION	Bedroom	Bathroom
FINISH	Stainless Steel	
PACKING	Blister	Blister
	1	1
AVAILABLE	On Request	On Request

ITEM	23PO*	24PO
FUNCTION	Bedroom	Bathroom
FINISH	Polished brass	
PACKING	Blister	Blister
	1	1
AVAILABLE	On Request	On Request

ITEM	21PO*	22PO
FUNCTION	Bedroom	Bathroom
FINISH	Antique brass	
PACKING	Blister	Blister
	1	1
AVAILABLE	On Request	On Request



## KNOB LOCKS

### TUBULAR BALL KNOBS

RESIDENTIAL LINE STANDARD SECURITY 400 000 LIFE CYCLES INCLUDES INSTALLATION ACCESSORIES



STAINLESS STEEL



10PO  
Bedroom



17PO  
Bathroom

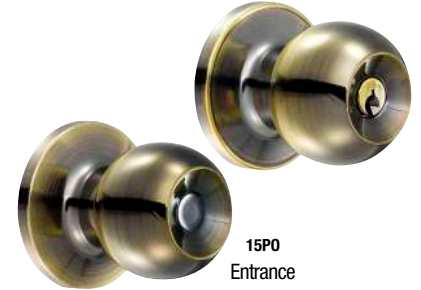

15PO  
Entrance

5 PINS 2 STANDARD KEYS ANSI 3 GRADE

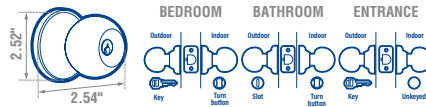

• For use on doors from 35 mm to 45 mm (1.38" to 1.77") thick.

ITEM	12PO*	10PO*	11PO
FUNCTION	Entrance	Bedroom	Bathroom
FINISH	Stainless steel		
PACKING	Blister	Blister	Blister
	1	1	1
AVAILABLE	On Request	On Request	On Request

ITEM	18PO*	16PO*	17PO
FUNCTION	Entrance	Bedroom	Bathroom
FINISH	Polished brass		
PACKING	Blister	Blister	Blister
	1	1	1
AVAILABLE	On Request	On Request	On Request

ITEM	15PO*	13PO*	14PO
FUNCTION	Entrance	Bedroom	Bathroom
FINISH	Antique brass		
PACKING	Blister	Blister	Blister
	1	1	1
AVAILABLE	On Request	On Request	On Request

### CYLINDRICAL BALL KNOBS

RESIDENTIAL LINE STANDARD SECURITY 200 000 LIFE CYCLES INCLUDES INSTALLATION ACCESSORIES EASY INSTALL

Prolok



NEW

STAINLESS STEEL



11POP  
Bedroom



14POP  
Bedroom



18POP  
Bathroom



45POP  
Bathroom

5 PINS 2 STANDARD KEYS ANSI 3 GRADE

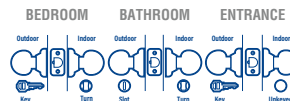
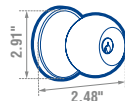

• For use on doors from 35 mm to 45 mm (1.38" to 1.77") thick.

ITEM	10POP*	11POP*	12POP
FUNCTION	Entrance	Bedroom	Bathroom
FINISH	Stainless steel		
PACKING	Blister	Blister	Blister
	1	1	1
AVAILABLE	On Request	On Request	On Request

ITEM	13POP*	14POP*	15POP
FUNCTION	Entrance	Bedroom	Bathroom
FINISH	Polished brass		
PACKING	Blister	Blister	Blister
	1	1	1
AVAILABLE	On Request	On Request	On Request

ITEM	16POP*	17POP*	18POP
FUNCTION	Entrance	Bedroom	Bathroom
FINISH	Antique brass		
PACKING	Blister	Blister	Blister
	1	1	1
AVAILABLE	On Request	On Request	On Request

ITEM	43POP*	44POP*	45POP
FUNCTION	Entrance	Bedroom	Bathroom
FINISH	Black steel		
PACKING	Blister	Blister	Blister
	1	1	1
AVAILABLE	On Request	On Request	On Request

## KNOB LOCKS

### HALF CUP CYLINDRICAL KNOBS

RESIDENTIAL LINE STANDARD SECURITY 200 000 LIFE CYCLES INCLUDES INSTALLATION ACCESSORIES EASY INSTALL

Prolok



NEW

STAINLESS STEEL



34POP



38POP

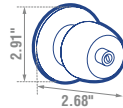

42POP

5 PINS 2 STANDARD KEYS ANSI 3 GRADE

• For use on doors from 35 mm to 45 mm (1.38" to 1.77") thick.

ITEM	34POP*	35POP*	36POP*
FUNCTION	Entrance	Bedroom	Bathroom
FINISH	Stainless steel		
PACKING	Blister	Blister	Blister
	1	1	1
AVAILABLE	On Request	On Request	On Request

ITEM	37POP*	38POP*	39POP*
FUNCTION	Entrance	Bedroom	Bathroom
FINISH	Polished brass		
PACKING	Blister	Blister	Blister
	1	1	1
AVAILABLE	On Request	On Request	On Request

ITEM	40POP*	41POP*	42POP*
FUNCTION	Entrance	Bedroom	Bathroom
FINISH	Black steel		
PACKING	Blister	Blister	Blister
	1	1	1
AVAILABLE	On Request	On Request	On Request

## DIGITAL LOCKS

### DIGITAL KNOB LOCK

RESIDENTIAL LINE HIGH SECURITY DIGITAL COMBINATION INCLUDES INSTALLATION ACCESSORIES

CONFIGURABLE PIN OF 4 TO 6 DIGITS

REQUIRES 4 AA BATTERIES

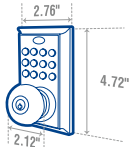

5 PINS 2 STANDARD KEYS ANSI 3 GRADE

- Silicone buttons, up to 80 combinations.
- Low power and vacation mode.
- Unlocking technology by PIN and low battery alarm.
- Error alarm after several failed attempts.
- Operated by key or digital unlocking from the outside.
- Uses 4 x AA batteries (not included).

ITEM	11CD
OPENING	Left or Right
LOCK	Digital and Key
PACKING	Box
	1
AVAILABLE	On Request

### DIGITAL LEVER LOCK

RESIDENTIAL LINE HIGH SECURITY DIGITAL COMBINATION INCLUDES INSTALLATION ACCESSORIES

CONFIGURABLE PIN OF 4 TO 6 DIGITS

REQUIRES 4 AA BATTERIES

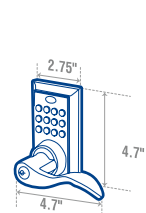

5 PINS 2 STANDARD KEYS ANSI 3 GRADE

- Silicone buttons, up to 80 combinations.
- Low power and vacation mode.
- Unlocking technology by PIN and low battery alarm.
- Error alarm after several failed attempts.
- Operated by key or digital unlocking from the outside.
- Uses 4 x AA batteries (not included).

ITEM	12CD
OPENING	Left or Right
LOCK	Digital and Key
PACKING	Box
	1
AVAILABLE	On Request

### DIGITAL LOCK

RESIDENTIAL LINE HIGH SECURITY DIGITAL COMBINATION INCLUDES INSTALLATION ACCESSORIES

CONFIGURABLE PIN OF 4 TO 8 DIGITS

REQUIRES 4 AA BATTERIES

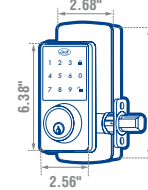

5 PINS 2 STANDARD KEYS ANSI 3 GRADE

- Touch panel, up to 80 combinations.
- Low power and vacation mode.
- Unlocking technology by PIN with low battery alarm.
- Error alarm after several failed attempts.
- Operated by key or digital unlocking from the outside.
- Thumb turn for manual unlocking from the inside.
- Uses 4 x AA batteries (not included).

ITEM	10CD
OPENING	Left and right
LOCK	Digital with key
PACKING	Box
	1
AVAILABLE	On Request

LOCKS FOR ALUMINUM DOORS



LOCKS FOR ALUMINUM DOORS EURO LINE

RESIDENTIAL LINE



STANDARD SECURITY



INCLUDES INSTALLATION ACCESSORIES

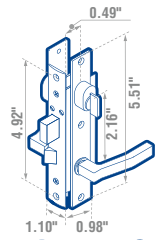

10CL



11CL



13CL

5 PINS 2 STANDARD KEYS

- Deadbolt operated with key on both sides.
- For swing doors.



ITEM	10CL
FUNCTION	Double cylinder
FINISH	White
PACKING	Box
	1
AVAILABLE	On Request

ITEM	11CL
FUNCTION	Double cylinder
FINISH	Black
PACKING	Box
	1
AVAILABLE	On Request

ITEM	13CL
FUNCTION	Double cylinder
FINISH	Gray
PACKING	Box
	1
AVAILABLE	On Request

LOCKS FOR ALUMINUM DOORS CLASSIC LINE

RESIDENTIAL LINE



STANDARD SECURITY



INCLUDES INSTALLATION ACCESSORIES

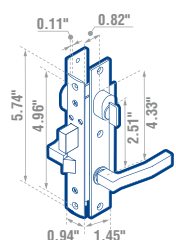

14CL



16CL



20CL



18CL

5 PINS 2 STANDARD KEYS

- Deadbolt operated with key on both sides.
- For swing doors.



ITEM	14CL	15CL
FUNCTION	Turn button-cylinder	Double cylinder
FINISH	Gray	
PACKING	Box	Box
	1	1
AVAILABLE	On Request	On Request

ITEM	16CL	17CL
FUNCTION	Turn button-cylinder	Double cylinder
FINISH	White	
PACKING	Box	Box
	1	1
AVAILABLE	On Request	On Request

ITEM	19CL	20CL
FUNCTION	Turn button-cylinder	Double cylinder
FINISH	Black	
PACKING	Box	Box
	1	1
AVAILABLE	On Request	On Request

ITEM	18CL
FUNCTION	Double cylinder
FINISH	Brown
PACKING	Box
	1
AVAILABLE	On Request

LOCKSMITH

## PANIC EXIT DEVICE



### SWEEP ONE TOUCH 1 POINT WITH HANDLE

COMERCIAL LINE STANDARD SECURITY

INCLUDES INSTALLATION ACCESSORIES

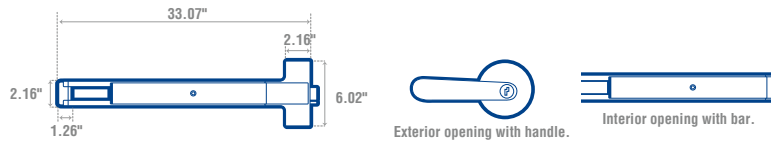

4 PINS 3 STANDARD KEYS ANSI 1 GRADE

- Adjustable to different door widths.
- Silent operation.

ITEM	FUNCTION	FINISH	AVAILABLE
10BA	Sweep one touch 1 point with handle	Aluminum	1 On Request

### HANDLE ANTI-PANIC BAR

COMERCIAL LINE STANDARD SECURITY

INCLUDES INSTALLATION ACCESSORIES

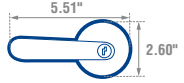

4 PINS 3 STANDARD KEYS ANSI 1 GRADE

- Made of zinc alloy.
- Suitable for right- and left-hand function.

ITEM	FUNCTION	FINISH	AVAILABLE
24MA	Spare part for 10BA	Satin nickel	1 On Request

### SWEEP ONE TOUCH 1 POINT

COMERCIAL LINE STANDARD SECURITY

INCLUDES INSTALLATION ACCESSORIES

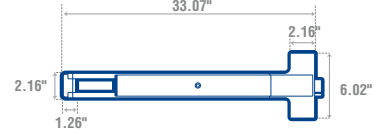

- Adjustable to different door widths.
- Silent operation.

ITEM	FUNCTION	FINISH	AVAILABLE
11BA	Sweep one touch 1 point	Aluminum	1 On Request

### SINGLE-POINT TOUCH BAR

COMERCIAL LINE STANDARD SECURITY

INCLUDES INSTALLATION ACCESSORIES

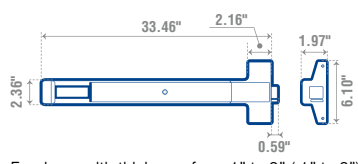

- For doors with thickness from 1" to 2" (1" to 2").
- Silent operation.

ITEM	FUNCTION	FINISH	AVAILABLE
L5501AL	Sweep one touch 1 point	Aluminum	1 On Request

## PANIC EXIT DEVICE

### 2 POINT UNIVERSAL BAR

COMERCIAL LINE



STANDARD SECURITY



INCLUDES INSTALLATION ACCESSORIES

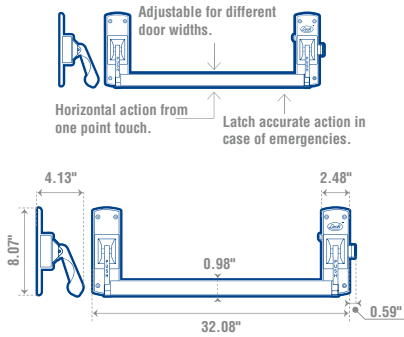

ANSI 1 GRADE

- For swing doors with thickness from 1" to 2" (approximately 1" to 2").
- Silent operation.

ITEM	FUNCTION	FINISH	QTY	AVAILABLE
L200AL	Touch 2 points	Aluminum	1	On Request

### 1 POINT UNIVERSAL BAR

COMERCIAL LINE



STANDARD SECURITY



INCLUDES INSTALLATION ACCESSORIES

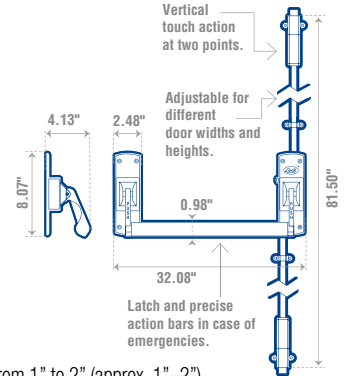
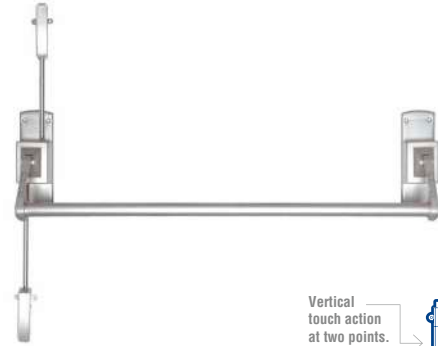

ANSI 1 GRADE

- For swing doors with thickness from 1" to 2" (approx. 1"-2").
- Silent operation.

ITEM	FUNCTION	FINISH	QTY	AVAILABLE
L220AL	Touch 1 points	Aluminum	1	On Request

## HANDLES

### NO.12 MODERN HANDLE

RESIDENTIAL LINE



INCLUDES INSTALLATION ACCESSORIES

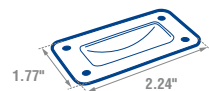

- Die-cut handle in a single-piece sheet.
- For sliding doors.

**BULK**

ITEM	FINISH	DISTANCE BETWEEN SCREWS	QTY	AVAILABLE
LJ1M12N	Satin chrome	2.75" x 1.18"	25	On Request

### SOLID STAINLESS STEEL BAR HANDLES

RESIDENTIAL LINE



STAINLESS STEEL



INCLUDES INSTALLATION ACCESSORIES

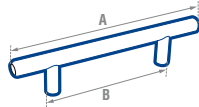

LJM124  
Solid stainless steel bar.

**BULK**

ITEM	FINISH	LENGTH (A)	DISTANCE BETWEEN SCREWS (B)	QTY	AVAILABLE
LJM124	Satin nickel	4.88"	2.51"	10	On Request
LJM156	Satin nickel	6.14"	3.77"	10	On Request
LJM188	Satin nickel	7.40"	5.03"	10	On Request
LJM220	Satin nickel	8.66"	6.30"	10	✓
LJM252	Satin nickel	9.92"	7.55"	10	On Request
LJM316	Satin nickel	12.44"	10.07"	10	On Request
LJM444	Satin nickel	17.48"	15.11"	10	On Request
LJM501	Satin nickel	19.72"	17.63"	10	On Request
LJM668	Satin nickel	26.30"	23.93"	10	On Request

### HOLLOW STAINLESS STEEL BAR HANDLES

RESIDENTIAL LINE



STAINLESS STEEL



INCLUDES INSTALLATION ACCESSORIES

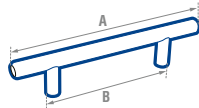

LJM124H  
Hollow stainless steel bar.

**BULK**

ITEM	FINISH	LENGTH (A)	DISTANCE BETWEEN SCREWS (B)	QTY	AVAILABLE
LJM124H	Satin nickel	4.88"	2.51"	10	On Request
LJM156H	Satin nickel	6.14"	3.77"	10	On Request
LJM188H	Satin nickel	7.40"	5.03"	10	On Request
LJM220H	Satin nickel	8.66"	6.30"	10	On Request
LJM252H	Satin nickel	9.92"	7.55"	10	On Request

## CLOSET ACCESSORY

### DOOR HANGER SET DOUBLE

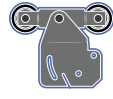
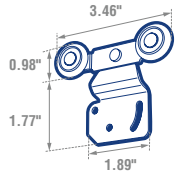

Double top rail.

- 14-gauge galvanized steel sheet body.
- Nylon wheels.
- Includes stopper, guide, and screws.
- For installation on right or left door.
- Closet rollers compatible with JJ-type rails.
- Smooth sliding once installed.

ITEM	BEARING	NUMBER OF BEARINGS	MAXIMUM LOAD	☐	AVAILABLE
<b>CCLOD</b>	15/16"	2	66.1 lb x sheet	1	✓



### DOOR HANGER SET SIMPLE



Simple top rail.

- 14-gauge galvanized steel sheet body.
- Nylon wheels.
- Includes stopper, guide, and screws.
- For installation on right or left door.
- Closet rollers compatible with JJ-type rails.
- Smooth sliding once installed.

ITEM	BEARING	NUMBER OF BEARINGS	MAXIMUM LOAD	☐	AVAILABLE
<b>CCLOS</b>	15/16"	1	66.1 lb x sheet	1	On Request



### DOOR HANGER SET FOR FLOOR

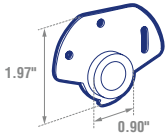

Floor.

- 16-gauge galvanized steel sheet body.
- Nylon wheels.
- Includes stopper, guide, and screws.
- For installation on right or left door.
- Closet rollers compatible with JJ-type rails.
- Smooth sliding once installed.

ITEM	BEARING	NUMBER OF BEARINGS	MAXIMUM LOAD	☐	AVAILABLE
<b>CCLOP</b>	15/16"	1	44 lb x sheet	1	On Request



### CLOSET TROLLEY RAIL TT 4 BEARINGS

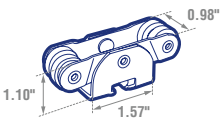

Quick door mounting system.

- 14-gauge steel sheet body.
- Acetal resin wheels.
- Closet rollers compatible with TT-type rails.
- Includes adjustment screw.
- Smooth sliding once installed.

ITEM	BEARING	NUMBER OF BEARINGS	MAXIMUM LOAD	☐	AVAILABLE
<b>CCLORT4</b>	15/16"	4	44 lbs	1	On Request



### CLOSET TROLLEY RAIL TT 2 BEARINGS



Quick door mounting system.

- 14-gauge steel sheet body.
- Acetal resin wheels.
- Closet rollers compatible with TT-type rails.
- Includes adjustment screw.
- Smooth sliding once installed.

ITEM	BEARING	NUMBER OF BEARINGS	MAXIMUM LOAD	☐	AVAILABLE
<b>CCLORT2</b>	15/16"	2	44 lbs	1	On Request





## RAILS AND TUBES FOR CLOSET

### RIAL TT FOR CLOSET

RESIDENTIAL LINE



RILAT2

RIALT2

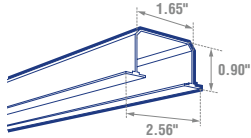

RIALT2, RIALT3, RILAT2 and RILAT3 need the trolley rial CCLORT4 and CCLORT2.

- Compatible with TT system roller.
- Can be assembled to any type of closet.

**BULK**

ITEM	MATERIAL	FINISH	LENGHT	Ø	AVAILABLE
RILAT2	Caliber 22 sheet	Liquid gray paint	3.3 ft	1	✓
RILAT3	Caliber 22 sheet	Liquid gray paint	8 ft	1	On Request
RIALT2	Aluminum	Natural	6.5 ft	1	On Request
RIALT3	Aluminum	Natural	9.8 ft	1	On Request

### RIAL JJ FOR CLOSET

RESIDENTIAL LINE

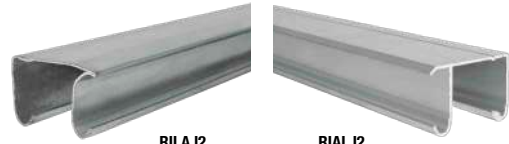

RILAJ2

RIALJ2

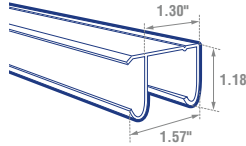

RILAJ2, RILAJ3, RIALJ2 and RIALJ3 need the trolley rial CCLOS and CCLOD.

- Compatible with JJ system roller.
- Can be assembled to any type of closet.
- Recommended for use with CCLOS or CCLOD.

**BULK**

ITEM	MATERIAL	FINISH	LENGHT	Ø	AVAILABLE
RILAJ2	Caliber 22 sheet	Liquid gray paint	3.3 ft	1	On Request
RILAJ3	Caliber 22 sheet	Liquid gray paint	8 ft	1	On Request
RIALJ2	Aluminum	Natural	6.5 ft	1	On Request
RIALJ3	Aluminum	Natural	9.8 ft	1	On Request

### OVAL TUBE FOR CLOSET

RESIDENTIAL LINE



0.59"

1.10"

- Lightweight hollow aluminum tube.
- Compatible with BCL0.
- For closet use.

**BULK**

ITEM	MATERIAL	LENGHT	Ø	AVAILABLE
TCL03	Aluminum	9.84 ft	1	On Request

### SUPPORT SET FOR OVAL TUBE

RESIDENTIAL LINE



INCLUDES INSTALLATION ACCESSORIES



- Zamac-made bracket.
- Compatible with TCL03.
- Easy to install with screws or rivets.

To hang clothes hooks in closet and also for curtain.

ITEM	MATERIAL	LENGHT	Ø	AVAILABLE
BCL0	Zamac		1	On Request

## ROLLERS FOR GATES AND WINDOWS

### GATE TROLLEYS

RESIDENTIAL LINE



LCP300

LCP500

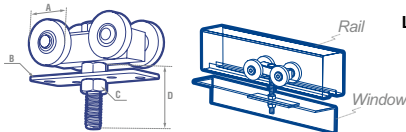

ITEM	WHEEL (A) diameter	PELLETS	BODY	PLATE (B) gauge	NUT (C)	SCREW (D)
LCP300	1-7/8"	3/16"	3/4"	12	3/8"	3/8" x 3-11/16"
LCP500	15/16"	1/8"	5/8"	14	5/16"	5/16" x 2-3/16"

- Square steel body.
- Carbon steel plate.
- Steel wheel with ball bearings.
- Carbon steel nut and bolt with hexagonal head.

ITEM	LOADING CAPACITY	Ø	AVAILABLE
LCP300	661 lbs	10	✓
LCP500	1,102 lbs	10	On Request

### WINDOW TROLLEY

RESIDENTIAL LINE

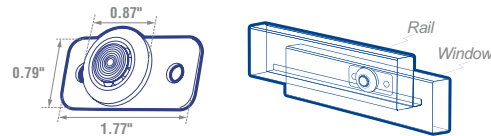

ITEM	DIAMETER	PELLETS	GAUGE	DRILLING
LCV20	7/8"	1/8"	14	3/16"

- 14-gauge carbon steel sheet body.
- 3/16" holes for window mounting.
- Steel wheel with ball bearings.

ITEM	LOADING CAPACITY	Ø	AVAILABLE
LCV20	44 lbs	10	On Request

## HYDRAULIC DOOR CLOSER

### Function

#### VALVE ADJUSTMENT



Turn the valve with a screwdriver to adjust the closing speed, latching speed, and back check function as needed.

#### Closing Speed Adjustment Valve



#### Adjustable Arm

#### Latching Speed Adjustment Valve



#### HOLD OPEN

Mechanism that allows the door to stay open automatically at a set angle.

#### BACK CHECK

Adjustable braking system that prevents the door from slamming into the wall.

#### LATCHING SPEED

Mechanism that controls the final closing speed of the door.

### HYDRAULIC DOOR CLOSER

COMERCIAL LINE



INCLUDES INSTALLATION ACCESSORIES



ADA COMPLIANT



- Aluminum body.
- Adjustable steel arm.
- Leak-proof hydraulic cylinder.
- Opening range: 180°.
- Closing speed and latch adjustment screws.
- Smooth closing.

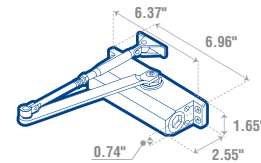

ITEM	HYDRAULIC DOOR CLOSERS	CAPACITY	MAXIMUM DOOR WIDTH REGULAR ARM		DOOR MAXIMUM PARALLEL ARM		⊞	AVAILABLE
			INSIDE	OUTSIDE	INSIDE	OUTSIDE		
12CP	Hold open	66.1-99.2 lb	35.82"	31.88"	31.88"	27.95"	1	On Request
15CP	Hold open	99.2-143.3 lb	42.12"	35.82"	35.82"	31.88"	1	On Request
11CP	Back check	66.1-99.2 lb	35.82"	31.88"	31.88"	27.95"	1	On Request
14CP	Back check	99.2-143.3 lb	42.12"	35.82"	35.82"	31.88"	1	On Request
10CP	Automatic	66.1-99.2 lb	35.82"	31.88"	31.88"	27.95"	1	On Request
13CP	Automatic	99.2-143.3 lb	42.12"	35.82"	35.82"	31.88"	1	On Request



### HYDRAULIC DOOR CLOSERS WITH 135° OPENING

COMERCIAL LINE



INCLUDES INSTALLATION ACCESSORIES



ADA COMPLIANT

Prolok



NEW

- Aluminum body.
- Adjustable steel arm.
- Leak-proof hydraulic cylinder.
- Opening range: 135°.
- Closing speed and final stroke adjustment screws.

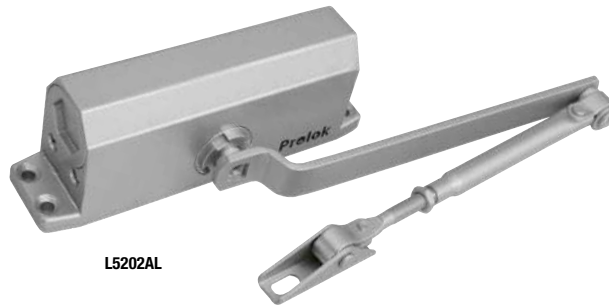

L5202AL

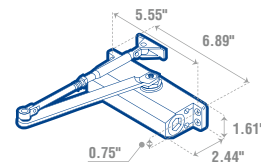

ITEM	HYDRAULIC DOOR CLOSERS	CAPACITY	MAXIMUM DOOR WIDTH REGULAR ARM		DOOR MAXIMUM PARALLEL ARM		⊞	AVAILABLE
			INSIDE	OUTSIDE	INSIDE	OUTSIDE		
L5202AL	Automatic	99 lb	3.0 ft	2.7 ft	2.7 ft	2.3 ft	1	On Request
L5203AL	Automatic	154 lb	3.5 ft	3.0 ft	3.0 ft	2.7 ft	1	On Request

## DOOR STOP

### DOOR STOP

RESIDENTIAL LINE



INCLUDES INSTALLATION ACCESSORIES



NEW

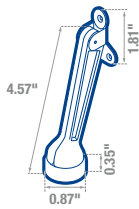

FIJPS



FIJPL



FIJPA

- Zinc alloy body.
- Non-slip rubber.
- Helps keep the door open.
- Prevents damage to doors and walls.
- Protects against forced entry.



ITEM	FIJPS	FIJPL	FIJPA
FINISH	Satin nickel	Polished brass	Antique brass
⊞	1	1	1
AVAILABLE	On Request	On Request	On Request

### MAGNETIC DOOR STOP

RESIDENTIAL LINE



INCLUDES INSTALLATION ACCESSORIES



NEW

### LADYBUG-TYPE DOOR STOPS

RESIDENTIAL LINE



INCLUDES INSTALLATION ACCESSORIES



NEW

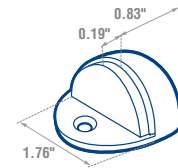
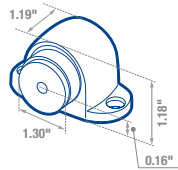

TOPS



TOPL



TOPA

- Zinc alloy body.
- Stopper with spring and magnetic action that secures the door.
- Helps keep the door open.
- Prevents damage to doors and walls.



- Zinc alloy body.
- Rubber reinforcement for door protection.
- Prevents impacts between the door and the wall.



ITEM	TOPMS	TOPS	TOPL	TOPA
FINISH	Satin nickel	Satin nickel	Polished brass	Antique brass
⊞	1	1	1	1
AVAILABLE	On Request	On Request	On Request	On Request

### ELBOW-TYPE DOOR STOPS

RESIDENTIAL LINE



INCLUDES INSTALLATION ACCESSORIES



NEW

### STRAIGHT DOOR STOPS

RESIDENTIAL LINE



INCLUDES INSTALLATION ACCESSORIES



NEW

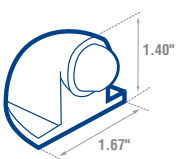

TOPCL

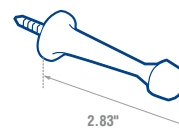

TOPRS



TOPRS

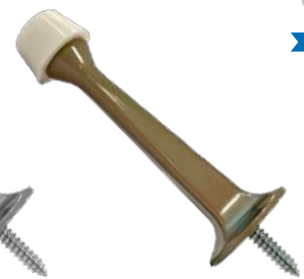

TOPRL

- Zinc alloy body.
- Rubber reinforcement for door protection.
- Prevents impacts between the door and the wall.



- Zinc alloy body.
- With rubber to cushion impacts.
- Prevents collisions between the door and the wall.



ITEM	TOPCS	TOPCL	TOPRS	TOPRL
FINISH	Satin nickel	Polished brass	Satin nickel	Polished brass
⊞	1	1	1	1
AVAILABLE	On Request	On Request	On Request	On Request

## DOOR SEAL

### DOOR SEAL AUTOMATIC

RESIDENTIAL LINE 



- Aluminum profile and high-strength PVC rubber.
- Easy to trim for installation on smaller doors.
- Automatic system: when the door opens, it lifts; when it closes, it lowers.
- Prevents the entry of dust, dirt, insects, rodents, and drafts.
- For use on entrance doors, bedrooms, patios, balconies, offices, homes, industry, etc.



**BULK**

ITEM	12GP	LGPA100A	LGPA100B	LGPA100N	LGPA100D	14GP
LENGTH	35.43"	39.37"	39.37"	39.37"	39.37"	39.37"
FINISH	Aluminum ●	Aluminum ●	White ○	Black ●	Golden ●	Bronze ●
	10	10	10	10	10	10
AVAILABLE	On Request	On Request	On Request	On Request	On Request	On Request

### DOOR SEAL CLASSIC

RESIDENTIAL LINE 

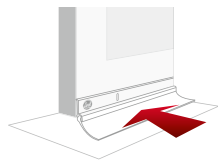

- Aluminum profile and high-strength PVC rubber.
- Easy to trim for installation on smaller doors.
- Prevents the entry of dust, dirt, insects, rodents, and drafts.
- For use on entrance doors, bedrooms, patios, balconies, offices, homes, industry, etc.



**BULK**

ITEM	10GP	LGP100A	LGP100B	LGP100N	LGP100D
LENGTH	35.43"	39.37"	39.37"	39.37"	39.37"
FINISH	Aluminum ●	Aluminum ●	White ○	Black ●	Golden ●
	10	10	10	10	10
AVAILABLE	On Request	On Request	On Request	On Request	On Request

### FOAM DUST GUARD WITH PVC COVER

RESIDENTIAL LINE 

PREVENTS THE ENTRY OF AIR, DUST AND INSECTS 

MAINTAINS THE TEMPERATURE 

REDUCES NOISE ((dB)) 



- PVC cover and polyethylene rollers.
- Easy-to-clean cover.
- For doors with a thickness of 3 to 4 centimeters.
- Easy to cut to adjust to size.



**NEW**

ITEM	15GPF	16GPF	17GPF
LENGTH	37.40 in	37.40 in	37.40 in
FINISH	Brown ●	Black ●	Gray ●
	12	12	12
AVAILABLE	On Request	On Request	On Request

## DOOR GUARDS

### DOOR GUARD WITH CHAIN

RESIDENTIAL LINE 

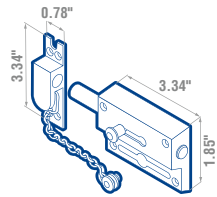

L048CSB



L048LBB



L048LAB

- Reinforced zamac body.
- Reinforced chain for greater security.
- Ideal for main doors and offices.



ITEM	L048CSB	L048LBB	L048LAB
FUNCTION	Safety pin	Safety pin	Safety pin
FINISH	Satin chrome ●	Polished brass ●	Antique brass ●
PACKING	Blister	Blister	Blister
	1	1	1
AVAILABLE	On Request	On Request	On Request

### SAFETY PINS FOR SWING DOORS

RESIDENTIAL LINE 

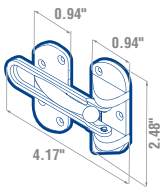

L044CSB



L044LBB



L044LAB

- Reinforced zamac body.
- Ideal for main doors and offices.



ITEM	L044CSB	L044LBB	L044LAB
FUNCTION	Safety	Safety	Safety
FINISH	Satin chrome ●	Polished brass ●	Antique brass ●
PACKING	Blister	Blister	Blister
	1	1	1
AVAILABLE	On Request	On Request	On Request

### SURFACE BAR BOLT

RESIDENTIAL LINE 



NEW

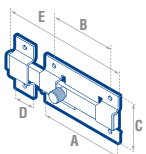

PASC8

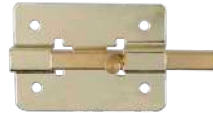

PASL8

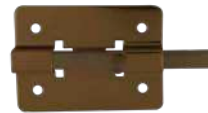

PASA8



PASN8

DIMENSION	A in	B in	C in	D in	E in
2"	2	1.46	1.57	0.35	2.52
3.1"	3.1	2.20	1.73	0.79	4.21
3.9"	3.9	2.99	2.17	0.98	5.71
4.7"	4.7	3.78	2.56	1.10	7.36

- Body made of steel.
- For vertical and horizontal use.



ITEM	PASC5	PASC8	PASC10	PASC12	PASL5	PASL8	PASL10	PASL12	PASA5	PASA8	PASA10	PASA12	PASN5	PASN8	PASN10	PASN12
FINISH	Polished chrome ●				Polished brass ●				Antique brass ●				Black steel ●			
SIZE	2"	3.1"	3.9"	4.7"	2"	3.1"	3.9"	4.7"	2"	3.1"	3.9"	4.7"	2"	3.1"	3.9"	4.7"
PACKING	Header card	Header card	Header card	Header card	Header card	Header card	Header card	Header card	Header card	Header card	Header card	Header card	Header card	Header card	Header card	Header card
	1	1	1	1	1	1	1	1	1	1	1	1	1	1	1	1
AVAILABLE	On Request	On Request	On Request	On Request	On Request	On Request	On Request	On Request	On Request	On Request	On Request	On Request	On Request	On Request	On Request	On Request

## DOOR GUARDS

### SURFACE-MOUNT BARREL BOLTS

RESIDENTIAL LINE  INCLUDES INSTALLATION ACCESSORIES 



NEW

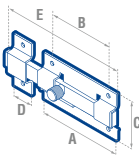

PABS6

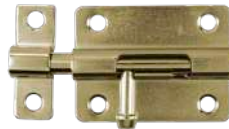

PABL6



PABA4



PABN6

SIZE	A in	B in	C in	D in	E in
1.57	1.54	1.10	1.34	0.47	2.01
2.36	2.17	1.57	1.57	0.55	2.83
3.15	2.91	2.28	1.57	0.55	3.62

- Body made of steel sheet for greater strength and firmness.
- For vertical and horizontal use.

ITEM	PABS4	PABS6	PABS8	PABL4	PABL6	PABL8	PABA4	PABA6	PABA8	PABN4	PABN6	PABN8
FINISH	Satin nickel ●			Polished brass ●			Antique brass ●			Black brass ●		
SIZE	1.57"	2.36"	3.15"	1.57"	2.36"	3.15"	1.57"	2.36"	3.15"	1.57"	2.36"	3.15"
PACKING	Blister	Blister	Blister	Blister	Blister	Blister	Blister	Blister	Blister	Blister	Blister	Blister
☞	1	1	1	1	1	1	1	1	1	1	1	1
AVAILABLE	On Request	On Request	On Request	On Request	On Request	On Request	On Request	On Request	On Request	On Request	On Request	On Request

### MAUSER TYPE PIN

RESIDENTIAL LINE 

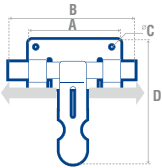

LPM85

- Body made of stamped steel sheet in a single piece.
- Carbon steel bar.
- For installation on left or right doors.
- Easy installation with screws, rivets, or welding.

ITEM	A in	B in	C in	D in
LPM85	3.42	0.59	0.19	3.59
LPM100	4.13	0.94	0.19	4.44
LPM130	5.11	1.10	0.23	5.82
LPM145	5.74	1.10	0.23	5.82

ITEM	SIZE	FINISH	☞	AVAILABLE
LPM85	3.34"	Galvanized	5	On Request
LPM100	3.93"	Galvanized	5	On Request
LPM130	5.11"	Galvanized	5	✓
LPM145	5.70"	Galvanized	5	On Request

### WINDOW PINS

RESIDENTIAL LINE 



PAVEC1

- Zamac body.
- Strike plate for better closure.
- Latch for casement windows.

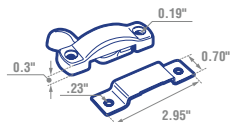

ITEM	FUNCTION	FINISH	DIMENSIONS	☞	AVAILABLE
PAVEN1	Without strike plate	Natural	2.87" x 0.62" x 1.57"	10	On Request
PAVEN2	Strike plate	Natural	2.87" x 0.62" x 1.57"	10	On Request
PAVEC1	Without strike plate	Chrome	2.95" x 0.62" x 1.57"	10	✓
PAVEC2	Strike plate	Chrome	2.95" x 0.62" x 1.57"	10	On Request

## DOOR HASP

### DOOR HASP

RESIDENTIAL LINE 

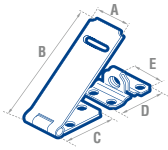

LPC412NIB



LPC412LBB

SIZE	A		B		C		D		E	
	mm	in	mm	in	mm	in	mm	in	mm	in
1-3/4"	19	0.75	49	1.92	20	0.80	11	0.45	16	0.64
2-1/2"	25	1.00	63	2.49	31	1.23	27	1.07	17	0.69
3-1/4"	38	1.50	87	3.43	38	1.52	36	1.43	42	1.68
4-1/2"	38	1.50	115	4.56	37	1.47	35	1.38	42	1.65
6"	45	1.77	158	6.22	78	3.08	44	1.75	46	1.81

- Body made of steel sheet.
- Weather-resistant finish.
- Ideal for gates, doors, and windows.

ITEM	LPC134NIB	LPC212NIB	LPC314NIB	LPC412NIB
FINISH		Satin nickel ●		
SIZE	1-3/4"	2-1/2"	3-1/4"	4-1/2"
PACKING	Blister	Blister	Blister	Blister
	1	1	1	1
AVAILABLE	On Request	On Request	On Request	On Request

ITEM	LPC134LBB	LPC212LBB	LPC314LBB	LPC412LBB
FINISH		Polished brass ●		
SIZE	1-3/4"	2-1/2"	3-1/4"	4-1/2"
PACKING	Blister	Blister	Blister	Blister
	1	1	1	1
AVAILABLE	On Request	On Request	On Request	On Request



## HAT HOOKS

### HAT HOOK

RESIDENTIAL LINE  INCLUDES INSTALLATION ACCESSORIES 

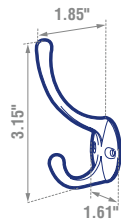

10PE



11PE

- Body made of zamac.
- For hanging clothes, hats, jackets, etc.

ITEM	FINISH		AVAILABLE
10PE	Polished brass ●	10	On Request
11PE	Satin nickel ●	10	On Request



### DOUBLE HAT HOOK

RESIDENTIAL LINE  INCLUDES INSTALLATION ACCESSORIES 

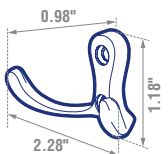

12PE



13PE

- Body made of zamac.
- For hanging clothes, hats, jackets, etc.

ITEM	FINISH		AVAILABLE
12PE	Polished brass ●	10	On Request
13PE	Satin nickel ●	10	On Request



## LETTERS AND NUMBERS

### LETTER 4" SLIM

RESIDENTIAL LINE 

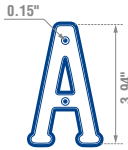

L701ACS

L701BCS

L701CCS

L701ALB

L701BLB

L701CLB

- Made of zamak.
- Corrosion and weather resistant.
- Easy to install.
- Perfect for signage on facades and doors.

ITEM	LETTER	FINISH	AVAILABLE
L701ACS	A	Satin chrome	On Request
L701BCS	B	Satin chrome	On Request
L701CCS	C	Satin chrome	On Request
L701DCS	D	Satin chrome	On Request

ITEM	LETTER	FINISH	AVAILABLE
L701ALB	A	Polished brass	On Request
L701BLB	B	Polished brass	On Request
L701CLB	C	Polished brass	On Request
L701DLB	D	Polished brass	On Request

### NUMBER 4" BOLD

RESIDENTIAL LINE 

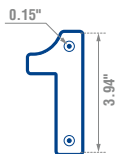

L601C

L602C

L603C

L61N

L62N

L63N

- Made of zamak.
- Corrosion and weather resistant.
- Easy to install.
- Perfect for signage on facades and doors.

ITEM	NUMBER	FINISH	AVAILABLE
L600C	0	Satin chrome	On Request
L601C	1	Satin chrome	✓
L602C	2	Satin chrome	On Request
L603C	3	Satin chrome	On Request
L604C	4	Satin chrome	On Request
L605C	5	Satin chrome	On Request
L606C	6	Satin chrome	On Request
L607C	7	Satin chrome	On Request
L608C	8	Satin chrome	On Request
L609C	9	Satin chrome	On Request

ITEM	NUMBER	FINISH	AVAILABLE
L60N	0	Black	✓
L61N	1	Black	✓
L62N	2	Black	✓
L63N	3	Black	✓
L64N	4	Black	✓
L65N	5	Black	✓
L66N	6	Black	✓
L67N	7	Black	✓
L68N	8	Black	✓
L69N	9	Black	✓

### NUMBER 4" SLIM

RESIDENTIAL LINE 

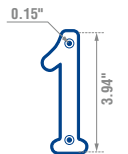

L6801CS

L6802CS

L6803CS

L6801LB

L6802LB

L6803LB

L681N

L682N

L683N

- Made of zamak.
- Corrosion and weather resistant.
- Easy to install.
- Perfect for signage on facades and doors.

ITEM	NUMBER	FINISH	AVAILABLE
L6800CS	0	Satin chrome	On Request
L6801CS	1	Satin chrome	On Request
L6802CS	2	Satin chrome	On Request
L6803CS	3	Satin chrome	On Request
L6804CS	4	Satin chrome	On Request
L6805CS	5	Satin chrome	On Request
L6806CS	6	Satin chrome	On Request
L6807CS	7	Satin chrome	On Request
L6808CS	8	Satin chrome	On Request
L6809CS	9	Satin chrome	On Request

ITEM	NUMBER	FINISH	AVAILABLE
L6800LB	0	Polished brass	On Request
L6801LB	1	Polished brass	On Request
L6802LB	2	Polished brass	On Request
L6803LB	3	Polished brass	On Request
L6804LB	4	Polished brass	On Request
L6805LB	5	Polished brass	On Request
L6806LB	6	Polished brass	On Request
L6807LB	7	Polished brass	On Request
L6808LB	8	Polished brass	On Request
L6809LB	9	Polished brass	On Request

ITEM	NUMBER	FINISH	AVAILABLE
L680N	0	Black	✓
L681N	1	Black	✓
L682N	2	Black	✓
L683N	3	Black	✓
L684N	4	Black	✓
L685N	5	Black	✓
L686N	6	Black	✓
L687N	7	Black	✓
L688N	8	Black	✓
L689N	9	Black	✓





CLASS	TYPE	PAGE	BRAND		
			URREA	SURTEK	URREA
Marketing products	Promotional items	696	•	•	•
	Coolers, cups and thermoses	698	•		
	Promotional textiles	698	•	•	
	Suitcases and backpacks	698	•	•	
	Dispenser racks	699	•	•	
	Floor displays	700	•	•	
	Display furniture	702	•	•	
	Mechanic benches and creepers	704	•	•	

[usa.urrea.com](http://usa.urrea.com)

We are constantly improving our products, that is why the information, characteristics and availability of them can change without prior notice.

## CATALOG

### CATALOG



ITEM	DESCRIPTION	☐	AVAILABLE
CUS26	Catalog 2026	1	✓

### PROMOTIONAL ITEMS

#### VINYL HARD COVER NOTEBOOK

**100 SHEETS**



ITEM	SIZE	☐	AVAILABLE
CUAD100	14 cm x 22.5 cm	1	✓

#### HARD COVER NOTEBOOK

**100 SHEETS**



ITEM	SIZE	☐	AVAILABLE
CUAD20	17.5 cm x 23 cm	1	✓

#### EXECUTIVE KEYCHAINS



- Brushed aluminum body.
- Diamond cut edges.

ITEM	DESCRIPTION	☐	AVAILABLE
LLAVU1	Executive keychain	1	On Request

#### TOOL-SHAPED KEYCHAINS



100



LLAV70



LLAV80



LLAV20

ITEM	DESCRIPTION	☐	AVAILABLE
100	Screwdriver keychain	6	✓
LLAV70	Screwdriver keychain	10	✓

ITEM	DESCRIPTION	☐	AVAILABLE
LLAV80	Pipe wrench keychain	10	✓
LLAV20	Mini pliers keychain	1	On Request

#### TOOL-SHAPED KEYCHAINS



100P



122090



F108P



LLPA100



127194



127195

ITEM	DESCRIPTION	☐	AVAILABLE
100P	Screwdriver keychain	25	✓
122090	Measure tape keychain	10	✓

ITEM	DESCRIPTION	☐	AVAILABLE
F108P	Combination wrench keychain	25	✓
LLPA100	Shovel keychain	1	On Request

ITEM	DESCRIPTION	☐	AVAILABLE
127194	Axe keychain	1	On Request
127195	Bottle opener	1	On Request

#### USB DRIVE – CIRCULAR SAW SHAPE

**32 GB**



- Durable PVC Body
- Reads at 12–20 MB/s
- Writes at 5–10 MB/s
- Compact Size: 6.6 x 3.2 x 5.6 cm

ITEM	CAPACITY	☐	AVAILABLE
USB32C	32 GB	1	On Request



#### USB DRIVE – CHAINSAW SHAPE

**32 GB**



- Durable PVC Body
- Reads at 12–20 MB/s
- Writes at 5–10 MB/s
- Compact Size: 10.8 x 3 x 3.5 cm

ITEM	CAPACITY	☐	AVAILABLE
USB32M	32 GB	1	On Request



**PROMOTIONAL ITEMS**

**USB DRIVE**

**64**  
GB



- Acrylic Body | Reads 8–10 MB/s
- Writes 4–8 MB/s
- 4.3 x 0.5 x 1.2 cm
- Keychain for Easy Carry

ITEM	CAPACITY	☞	AVAILABLE
<b>USB64S</b>	64 GB	1	✓

**USB DRIVE - KEY SHAPE**

**64**  
GB



- Durable Metal Body
- Reads at 12–18 MB/s
- Writes at 5–10 MB/s
- Compact Size: 5.5 x 2.5 cm

ITEM	CAPACITY	☞	AVAILABLE
<b>USB64L</b>	64 GB	1	✓

**STAINLESS STEEL SMOOTH INK PEN**



- Universal Screen Touch Stylus on Top
- Smooth-Flowing Ink for Comfortable Writing

ITEM	DESCRIPTION	☞	AVAILABLE
<b>PLAU</b>	Stainless Steel Smooth Ink Pen	1	✓

**STAINLESS STEEL SMOOTH INK PEN**



ITEM	DESCRIPTION	☞	AVAILABLE
<b>PLAS</b>	Stainless Steel Smooth Ink Pen	1	✓

**BLACK INK MULTI-FUNCTION PEN**



Multi-Function Tool:

- Pen
- Flathead Screwdriver
- Phillips Screwdriver
- Bubble Level
- Ruler (cm & in)
- Screen Touch Stylus



- Aluminum Body
- Textured for Better Grip

ITEM	DESCRIPTION	☞	AVAILABLE
<b>PLMS6</b>	Black Ink Multi-Function Pen	1	✓

**MEDIUM POINT BLACK PLASTIC PEN**



- Medium Point Pen with Cushion Grip
- Retractable Tip for Easy Storage
- Comfortable to Hold

ITEM	DESCRIPTION	☞	AVAILABLE
<b>PLMU</b>	Medium Point Black Plastic Pen	10	✓

**MEDIUM POINT BLACK PLASTIC PEN**



- Medium Point Pen
- Retractable Tip for Easy Storage

ITEM	DESCRIPTION	☞	AVAILABLE
<b>PLMS</b>	Medium Point Black Plastic Pen	10	✓

**MEDIUM POINT BLACK PLASTIC PEN**



- Medium Point Pen
- Retractable Tip for Easy Storage

ITEM	DESCRIPTION	☞	AVAILABLE
<b>PLML</b>	Medium Point Black Plastic Pen	10	✓

**ENTRANCE MAT**



- Flexible PVC Vinyl
- 9.5 mm Thick
- Non-Slip Surface Entrance Mat

ITEM	DIMENSIONS	☞	AVAILABLE
<b>UMAT</b>	110 cm x 60 cm	1	✓

**ENTRANCE MAT**



- Flexible PVC Vinyl
- 9.5 mm Thick
- Non-Slip Surface Entrance Mat

ITEM	DIMENSIONS	☞	AVAILABLE
<b>SMAT</b>	110 cm x 60 cm	1	On Request

## COOLERS, DRINKWARE & THERMOS

### STAINLESS STEEL THERMOS



URRER  
SUPERIOR QUALITY AFFORDABLE TOOLS



- BPA-Free
- Double-Walled
- Safety Plastic Lid



ITEM	CAPACITY	AVAILABILITY
TER60	600 ml	On Request

### LAPTOP BACKPACK WITH PADDED BACK



SURTEK  
TOOLS FOR SPECIALISTS



NEW

- Laptop Compartment 15"
- 20 kg Capacity
- Multifunctional Pockets
- Padded Straps
- Covered Top Handle



ITEM	DIMENSIONS	AVAILABILITY
MOCHS	38 cm x 25 cm x 49 cm	✓

## TRAVEL BAGS & BACKPACKS

### LAPTOP BACKPACK WITH PADDED BACK



URRER  
SUPERIOR QUALITY AFFORDABLE TOOLS



NEW

- Laptop Compartment up to 17"
- 30 kg Capacity
- Multiple Pockets
- Padded Straps & Back
- Reinforced Top Handle with Steel Cable



ITEM	DIMENSIONS	AVAILABILITY
MOCHU	40 cm x 20 cm x 50 cm	✓

### PORTFOLIO LAPTOP BACKPACK



URRER  
SUPERIOR QUALITY AFFORDABLE TOOLS



NEW

- Built-in Headphone Jack



- Laptop Compartment up to 15"
- 20 kg Capacity
- High-Strength Polyester
- Strap Compartment



ITEM	DIMENSIONS	AVAILABILITY
PORTU	30.5 cm x 38 cm x 10.2 cm	✓

## BRANDED APPAREL

### CLOSED RED SPANDEX CAP



URRER  
SUPERIOR QUALITY AFFORDABLE TOOLS



NEW

- Low-Profile Cap
- Polyester & Microfiber Fabric
- Embroidered Logo
- One Size
- Soft Front Panel



ITEM	DIMENSIONS	AVAILABILITY
GOUC	Red Polyester	On Request

### GREY HEATHER CAP



URRER  
SUPERIOR QUALITY AFFORDABLE TOOLS



NEW

- Heather Fabric Cap
- Raised Logo
- One Size
- Soft Front Panel
- Strap Closure
- Custom Edge Binding



ITEM	DIMENSIONS	AVAILABILITY
GOUJA	Gray Soft front panel	✓

### BLACK LASER-CUT CAP



URRER  
SUPERIOR QUALITY AFFORDABLE TOOLS



NEW

- One Size
- Structured Front Panel
- Adjustable Strap Closure



ITEM	DIMENSIONS	AVAILABILITY
GOUTR	Laser-Cut Cap	✓

### TRUCKER CAP



SURTEK  
TOOLS FOR SPECIALISTS



NEW

- Trucker-Style Cap
- Embroidered Logo
- One Size



ITEM	DIMENSIONS	AVAILABILITY
GOSM1	Trucker cap	On Request

**DISPENSER RACKS FOR SLAT WALL DISPLAY AND PEG BOARD**

**6 -16 LB SLEDGE HAMMER RACK**



Product not included.

- Made of Steel
- Holds 4 Pieces

ITEM	DIMENSIONS	AVAILABILITY
RMARRO4	5" x 12 x 11"	1 On Request

**RACK DISPENSER FOR SLEDGE HAMMER 2 TO 4 LB**



Product not included.

- Made of Steel
- Holds 6 Pieces

ITEM	DIMENSIONS	AVAILABILITY
RMARRO	3" X 9" x 4"	1 ✓

**HAMMERS RACK**



Product not included.

- Made of Steel
- Holds 5 Pieces
- Built-in Price Tag Holder

ITEM	DIMENSIONS	AVAILABILITY
RMARTF	3" x 10" x 7"	1 ✓

**CROSS WRENCH DISPENSER RACK**



NEW



Product not included.

- Made of Steel
- Holds 6 Pieces

ITEM	DIMENSIONS	AVAILABILITY
RCRUZ	13 cm x 19 cm x 30 cm	1 ✓

**LEVEL DISPENSER RACK**



NEW



Product not included.

- Made of Steel
- Holds 36 Pieces

ITEM	DIMENSIONS	AVAILABILITY
RNIV5	40.8 cm x 27 cm x 28 cm	1 ✓

**POWER TOOL DISPENSER RACK**



NEW



Product not included.

- Made of Steel
- Built-in price tag holder

ITEM	DIMENSIONS	AVAILABILITY
RHELEF	31 cm x 30 cm x 9 cm	1 ✓

**AXE DISPENSER RACK**



NEW



Product not included.

- Made of Steel
- Holds 3 Pieces

ITEM	DIMENSIONS	AVAILABILITY
RHACHA	14.6 cm x 18 cm x 17 cm	1 ✓

**MASON'S TROWEL DISPENSER RACK**



NEW



Product not included.

- Made of Steel
- Holds 6 Pieces

ITEM	DIMENSIONS	AVAILABILITY
RCUCH	16 cm x 16 cm x 31 cm	1 ✓

**FLOATS DISPENSER RACK**



NEW



Product not included.

- Made of Steel
- Holds 6 Pieces

ITEM	DIMENSIONS	AVAILABILITY
RFLOTA6	28.5 cm x 34 cm x 10.5 cm	1 ✓

**TROWELS DISPENSER RACK**



NEW



Product not included.

- Made of Steel
- Holds 6 Pieces

ITEM	DIMENSIONS	AVAILABILITY
RLLANA	30 cm x 23.5 cm x 9.2 cm	1 ✓

**LONG-HANDLED TOOL DISPENSER RACK**

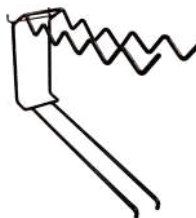

NEW



Product not included.

- Made of Steel
- Holds 5 Pieces

ITEM	DIMENSIONS	AVAILABILITY
RMULTI	16.8 cm x 41.7 cm x 40.4 cm	1 ✓

**SHOVEL DISPENSER RACK**



NEW



Product not included.

- Made of Steel
- Holds 5 Pieces

ITEM	DIMENSIONS	AVAILABILITY
126287	3" x 9" x 2"	1 On Request

## DISPENSER RACKS FOR SLAT WALL DISPLAY AND PEG BOARD

### Y-HANDLE SLEDGEHAMMER & SHOVEL RACK



NEW

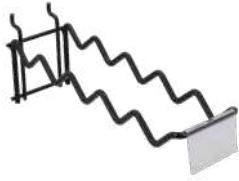

- Made of Steel
- Holds 5 Pieces
- Built-in price tag holder



ITEM	DIMENSIONS	☐	AVAILABLE
RMAP	32 cm x 9 cm x 11 cm	1	✓

### RACK DISPENSER MULTIPLE



Product not included.

- Made of Steel
- Holds 4 Pieces



ITEM	DIMENSIONS	☐	AVAILABLE
RMUL6	5 cm x 23.5 cm x 9 cm	1	✓

### MULTI-TOOL DISPENSER RACK



NEW

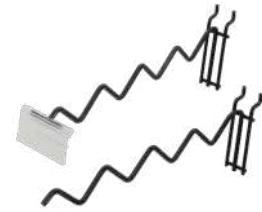

- Made of Steel
- Holds 4 Pieces
- With Price Tag Holder/ Adjustable for Multiple Tool Sizes



ITEM	DIMENSIONS	☐	AVAILABLE
RMUL1	33 cm x 4 cm x 10 cm	1	✓

### RACK DISPENSER FOR HANDSAW



Product not included.

- Made of Steel
- Holds 6 Pieces

ITEM	DIMENSIONS	☐	AVAILABLE
RSERRU	25.5 cm x 29 cm x 10 cm	1	On Request

### PICK & MATTOCK DISPENSER RACK



NEW

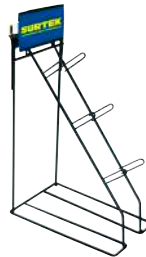

Product not included.

- Made of Steel
- Holds 3 Pieces

ITEM	DIMENSIONS	☐	AVAILABLE
DTAL	15.5 cm x 30.5 cm x 50 cm	1	✓

### DISPLAY BASKETS



NEW



CANA101



CANA100



Product not included.

- Made of Steel
- Wire Body
- Electrostatic Paint Finish

ITEM	DIMENSIONS	☐	AVAILABLE
CANA100	31 cm x 31 cm x 15 cm	1	On Request
CANA101	60 cm x 31 cm x 15 cm	1	✓

## FLOOR DISPLAYS

### PRY BAR DISPENSER



Product not included.

- Made of Steel
- Holds 15 Pieces

ITEM	DIMENSIONS	☐	AVAILABLE
RBARRE	30 cm x 30 cm x 130 cm	1	✓

### SLEDGE HAMMER RACK



Product not included.

- Made of Steel
- Holds 54 Pieces

ITEM	DIMENSIONS	☐	AVAILABLE
RMARRU	98 cm x 64 cm x 114 cm	1	✓

### FLOOR DISPLAY FOR STRIKE TOOLS



Product not included.

- Made of Steel
- Holds Pry Bars
- Hammers & Sledge
- Holds 15 pieces

ITEM	DIMENSIONS	☐	AVAILABLE
RGOLPE	138 cm x 64 cm x 150 cm	1	On Request

FLOOR DISPLAYS

SHOVEL & BROOM FLOOR RACK



NEW



Product not included.



- Made of Steel
- Holds Shovels & Brooms
- Includes Screws & Anchors for Wall Mounting

ITEM	DIMENSIONS	AVAILABILITY
RPALA	122 cm x 30 cm x 102 cm	1 AVAILABLE ✓

SHOVEL AND PITCHFORK FLOOR RACK



NEW



Product not included.



- Made of Steel
- Holds 8 pieces

ITEM	DIMENSIONS	AVAILABILITY
126246	70 cm x 70 cm x 180 cm	1 AVAILABLE ✓

FLOOR DISPLAY FOR CHAIN



Product not included.



- Made of Steel
- Holds 4 Buckets

ITEM	DIMENSIONS	AVAILABILITY
RCAD4	45 cm x 40 cm x 202 cm	1 On Request

ELECTRIC GENERATOR DISPLAY RACK



NEW



Product not included.



- Steel construction.
- Three-tier display.
- Wheels for effortless mobility.

ITEM	DIMENSIONS	AVAILABILITY
RGENE	89 cm x 61 cm x 170 cm	1 AVAILABLE ✓

BOTTLE JACK DISPENSER



Product not included.



- Made of Steel
- Holds 10 Pieces
- Includes Interchangeable Brand Graphic

ITEM	DIMENSIONS	AVAILABILITY
DB1401E	73.5 cm x 73.5 cm x 175 cm	1 On Request

METAL PLATFORM



NEW

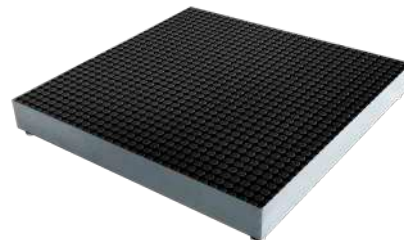

- With Non-Slip Rubber

ITEM	DIMENSIONS	AVAILABILITY
TARM	90 cm x 90 cm	1 AVAILABLE ✓

## TOOL DISPLAY FURNITURE

### TOOL DISPLAY TABLE



- Steel Rack
- Easy Installation
- Powder-Coated Finish
- Comes with Interchangeable Brand Signage and Header

ITEM	DIMENSIONS	☞	AVAILABLE
TEX	60 cm x 140 cm	1	✓

### STANDALONE PERIMETER GONDOLAS



- Modular Steel Display
- Perforated Metal Panel
- Tool-Free Assembly
- Powder-Coated Finish

ITEM	DIMENSIONS	☞	AVAILABLE
GONU	93 cm x 47 cm x 220 cm	1	On Request
GONS	93 cm x 47 cm x 220 cm	1	On Request

### PERIMETER GONDOLA WITH METAL PANEL

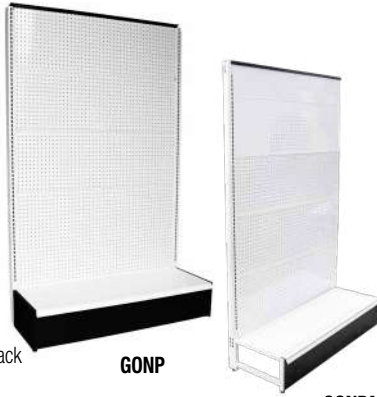

- Modular Steel Display Rack
- Perforated Metal Panel
- Tool-Free Assembly
- Powder-Coated Finish

ITEM	DIMENSIONS	☞	AVAILABLE
GONP	127 cm x 50 cm x 200 cm	1	✓
GONPA	120 x 50 x 200 cm version with extra section.	1	✓

### METAL ISLAND GONDOLA



- Modular Steel Display Rack
- Perforated Metal Panel
- Tool-Free Assembly
- Powder-Coated Finish
- Comes with Interchangeable Brand Signage

ITEM	DIMENSIONS	☞	AVAILABLE
GONI	90 cm x 140 cm x 92 cm	1	On Request

### CENTRAL GONDOLAS WITH METAL PANELS

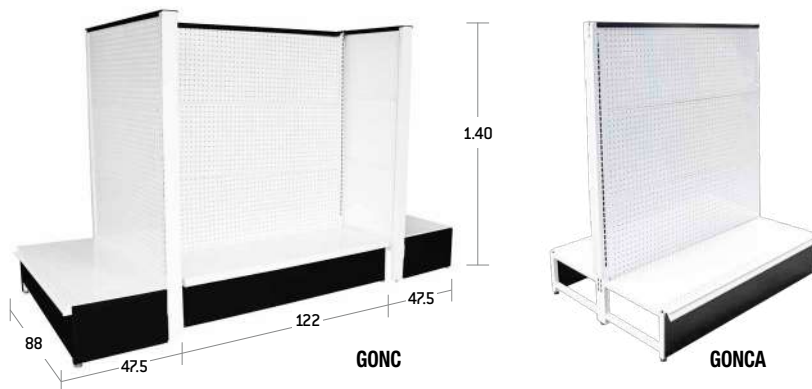

- Modular Steel Display Rack
- Perforated Metal Panel
- Tool-Free Assembly
- Powder-Coated Finish

ITEM	DIMENSIONS	☞	AVAILABLE
GONC	218 x 88 x 140 cm	1	On Request
GONCA	218 x 88 x 140 cm Additional section without header, includes single post.	1	✓



FURNITURE FOR EXHIBITION

METAL HOOK WITH PRICE TAG TAB



124128

- Made of steel.
- Works with slotted and perforated panels.

ITEM	DIMENSIONS	☞	AVAILABLE
124128	4" length	100	On Request
124129	6" length	100	✓
124130	8" length	100	✓



8" STRAIGHT HOOK



- Made of steel.
- Works with slotted and perforated panels.

ITEM	DIMENSIONS	☞	AVAILABLE
RDIS	8" length	1	On Request



PRICE TAG HOLDER



- Made of plastic.

ITEM	DIMENSIONS	☞	AVAILABLE
MPORT	14.5 x 10 cm	1	✓



NEW



MULTI-PURPOSE SHELF



- Made of steel.
- Works with slotted and perforated panels.
- Powder Coated finish

ITEM	DIMENSIONS	☞	AVAILABLE
LCMUL	55 x 28 x 4 cm	1	✓



GONDOLA SHELF



- Made of steel.
- For island or endcap gondolas.
- 3-tooth bracket, flat or inclined.
- Powder coated finish

ITEM	DIMENSIONS	☞	AVAILABLE
ENCAB	84.5 x 30.5 cm	1	✓



GONDOLA SHELF



- Made of steel.
- For island or endcap gondolas.
- 3-tooth bracket, flat or inclined.
- Powder Coated Finish.

ITEM	DIMENSIONS	☞	AVAILABLE
ENGON	120 x 40 cm	1	On Request



WIRE FRONT FOR SHELF



- Steel construction.
- Fits central and perimeter shelves.
- Keeps products securely in place.
- Durable electrostatic coating.

ITEM	DIMENSIONS	☞	AVAILABLE
FRM	120 x 8 cm	1	On Request



WIRE DIVIDER FOR SHELF



- Steel construction.
- Easy to install on shelves.
- Enhances product organization and visibility

ITEM	DIMENSIONS	☞	AVAILABLE
DVM	24 x 8 cm	1	On Request



## FURNITURE FOR EXHIBITION

### CASCADE RACK

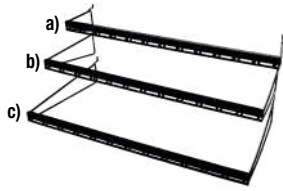

- Made of steel.
- Works with slotted and perforated panels.



ITEM	DIMENSIONS	⊞	AVAILABLE
RECAGA	Cascade-Type Rack 60 x 12 x 10 cm	1	On Request

### GONDOLA BAR SET, CASCADE TYPE

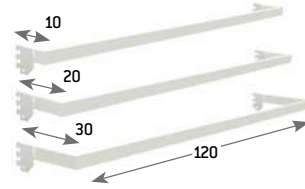

- Steel construction.
- Adjustable on central or perimeter gondolas.
- Comes with 35 hooks.



ITEM	DIMENSIONS	DIMENSIONS	⊞	AVAILABLE
JBAR	120 x 10 cm, 20 and 30 cm		1	✓

### CASCADE BAR SET

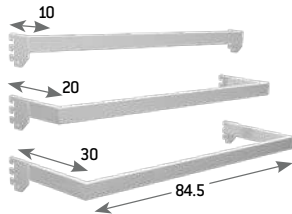

NEW

- Steel construction.
- Adjustable on central or perimeter gondolas.
- Comes with 30 hooks.



ITEM	DIMENSIONS	⊞	AVAILABLE
JBARC	84.5 x 10 cm, 20 cm and 30 cm	1	On Request

### CASCADE BAR HOOK



- Steel construction.
- Designed exclusively for cascade bar sets.



ITEM	DIMENSIONS	⊞	AVAILABLE
GBAR	4" length	100	✓

### COUNTER BAR STOOL



- Sturdy 4-Leg Chrome Steel Frame.
- Non-slip feet.
- Comfortable padded seat.
- Supports up to 150 kg.



ITEM	HEIGHT	DIAMETER	⊞	AVAILABLE
9988	75 cm	35 cm	1	On Request

### COUNTER BAR STOOL



- Sturdy 4-Leg Chrome Steel Frame.
- Non-slip feet.
- Comfortable padded seat.
- Supports up to 150 kg.



ITEM	HEIGHT	DIAMETER	⊞	AVAILABLE
137079	77 cm	35 cm	1	On Request

SUPERIOR QUALITY AFFORDABLE TOOLS

# SUPERIOR Comfort

COUNTER BAR STOOL

usa.urrea.com

ITEM	PAGE	ITEM	PAGE	ITEM	PAGE	ITEM	PAGE	ITEM	PAGE	ITEM	PAGE
U000A	386	U10024LS	378	U10040	176	U10116X	267	S107053	365	S107280	378
U000AA	385	U10024M	177	U10041	176	U101A <small>NEW</small>	545	S107054	365	S107281	378
U000D	385	U10025	176	U10041L	177	S101F <small>NEW</small>	545	S107055	365	S107282	378
U000F	385	U10025L	177	U10041M	177	U10208	267	S107056	365	S107283	379
U000LL	386	U10025T	175	U10042	176	U10210	267	S107058	365	S107284	379
U000N	385	U10026	176	U10043	176	S102105	154	S107064	364	S107285	379
U002645	385	U10026L	177	U10044	176	U10212	267	S107066	364	S107288	357
U00MM25	385	U10027	176	U10044L	177	U10213	267	S107068	364	S107289	357
U07524LS	378	U10027L	177	U10045	176	U10214	267	S107092	365	S107290	356
S10	381	U10027M	177	U10046	176	U10216	267	S107093	365	S107292	357
U100	696	U10028	176	U10046M	177	S103507	154	S107094	365	S107293	389
U10000L	177	U10028L	177	U10047	176	U10410	267	S107096	366	S107295	363
U10000LH	156	U10029	176	U10048	176	U10412	267	S107097	366	S107296	363
U10000P1	182	U10029L	177	U10050	176	U10413	267	S107098	366	S107297	356
U10000P2	182	U10030	176	U10050M	177	U10414	267	S107100 <small>NEW</small>	228	S107299	401
U10000P3	182	U10030L	177	U10052	176	S104915	154	U107111	366	U1072M	208
U10000R1	182	U10030M	177	S100522	191	S10504	267	S107114	365	S107303	432
U10000R2	182	U10031	176	S100528	202	U10504X	267	S107115	365	S107304	432
U10000R3	182	U10031L	177	S100530	202	S105120	280	S107116	365	S107311	431
U10000R4	182	U10032	176	S100532	202	S1051E <small>NEW</small>	189	S107117	365	S107313	395
U10000R5	182	U10032L	177	S100534	202	U1051M	208	S107118	365	S107314	381
U10000R6	182	U10032M	177	S100536	202	S1051ME <small>NEW</small>	191	S107142	364	S107315	381
U10004	179	U10033	176	S100538	202	S1051MR <small>NEW</small>	191	S107143	364	S107319	381
U10004B	179	U10033M	177	U10054	176	S1051R <small>NEW</small>	189	S107200	375	S107323	386
U10012	176	U10033ML	378	S100540	202	U10520	267	S107202	374	S107325 <small>NEW</small>	386
U10013	176	U10033T	175	S100544	202	U10520X	267	S107203	374	S107326 <small>NEW</small>	386
U10013DS	378	U10034	176	S100545	202	U1052M	208	S107204	374	S107327 <small>NEW</small>	386
U10014	176	U10034L	177	S100546	202	S1052MR <small>NEW</small>	191	S107206	374	S107329	386
U10014L	177	U10034T	175	S100547	202	S1052R <small>NEW</small>	189	S107209	374	S107331	386
U10015	176	U10035	176	S100548	202	U10536	267	S107212	374	S107332 <small>NEW</small>	386
U10015L	177	U100356	191	U10055M	177	U10536X	267	S107216	375	S107336	386
U10016	176	S100357	191	U10056	176	U1053M	208	S107218	375	S107343	395
S100160	189	S100358	191	S100568	202	U1054M	208	S107219	376	S107344	395
S100162	189	S100359	191	S100569	203	U10552	267	S107221	389	S107346	383
S100164	189	U10035L	177	S100574	200	U10552X	267	S107222	389	S107358	432
S100166	189	U10036	176	S100575	201	U10560	267	S107224	388	S107361	400
S100168	189	U100360	191	S100576	200	S105605	110	S107225	388	S107362	400
U10016L	177	U100361	191	S100577	200	U10560X	267	S107227	385	S107365	395
U10017	176	S100362	191	S100578	203	U10576	267	S107228	385	S107367	393
S100170	189	S100363	191	S100579	203	U10576X	267	S107229	385	S107368	390
S100172	189	U100364	191	U10058	176	U1057M	208	S107230	385	S107369	390
S100174	189	S100365	191	S100580	203	U10584	267	S107234	356	S107373 <small>NEW</small>	594
S100176	189	S100366	191	S100581	203	U10584X	267	S107236	356	S107376	390
S100178	189	U100367	191	S100582	203	U10592	267	S107238	387	S107377	396
U10017L	177	U100368	191	S100583	203	U10592X	267	S107239	387	S107378	388
U10018	176	S100369	191	S100584	203	U10607	180	S107246	389	S107379	402
S100180	189	U10036L	177	S100585	203	U10607B	180	S107249	357	U1073M	208
S100182	189	U10036M	177	S100586	203	U10609	180	S107251	374	U1077M	208
S100184	189	U10037	176	S100587	203	U10609B	180	S107252	374	U1079M	208
S100186	189	S100370	191	S100588	203	U1061M	208	S107253	374	S108100	481
U10018L	177	S100371	191	S100589	203	U1064M	208	S107254	390	S108101	482
U10019	176	U100372	191	S100590	203	U10657	181	S107256	396	S108103	481
S100190	189	S100373	191	S100591	203	U10657RK	181	S107259	384	S108104	480
S10019L	177	S100374	191	S100592	203	U1065M	208	S107264	379	S108105	481
U10020	176	S100375	191	U10060M	177	U10670	181	S107267	379	S108106	481
U10020L	177	U100376	191	U10062	176	U10670B	181	S107268	379	S108107	481
U10021	176	S100377	191	U10064	176	S107024	368	S107269	380	S108108	480
U10021L	177	S100378	191	U10065M	177	S107025	368	S107270	380	S108109	480
U10022	176	U100379	191	U10066	176	S107026	368	S107271	383	S108110	481
U10022L	177	U10037L	177	U10068	176	S107028	368	S107272	383	S108111	481
U10022T	175	U10038	176	U10072	176	S107030	368	S107274	380	S108112	480
U10023	176	S100380	191	S100P <small>NEW</small>	696	S107040	358	S107275	389	S108113	481
U10023L	177	S100382	191	U10108	267	S107044	358	S107276	390	S108114	482
U10024	176	U10038L	177	U10108X	267	S107051	365	S107277	393	S108117	482
U10024L	177	U10039	176	U10116	267	S107052	365	S107279	378	S108121	481

# 28 NUMERICAL INDEX

ITEM	PAGE	ITEM	PAGE	ITEM	PAGE	ITEM	PAGE	ITEM	PAGE	ITEM	PAGE
S 108122	481	U 1100H	208	S 114213	637	S 115144	282	U 1185	213	S 119262	521
S 108123	480	U 1100I	208	S 114214	637	S 115157	588	U 1185M	213	S 119263	520
S 108124	481	U 1100IM	208	S 114215	637	S 115158	588	U 1186	213	S 119264	521
S 108125	481	U 1100SM	208	S 114216	637	S 115200	292	U 1186M	213	S 119265	521
S 108126	480	S 110M	197	S 114217	637	U 1155	208	U 1187M	213	S 119267	521
S 108131	493	U 11114	267	S 114218	637	S 115M	197	S 118M	197	S 119268	520
S 108140	480	S 111M	197	S 114219	637	U 1160	208	U 1190A	212	S 119269	520
S 108141	480	U 1120	208	S 114220	636	U 11610	267	U 1190M	212	S 119270	520
S 108142	480	U 1122	208	S 114224	636	U 11612	267	U 1191	212	S 119271	520
S 108145	482	U 1125	208	S 114225	637	U 1162	208	S 119153	518	S 119272	520
S 108146	482	S 112513	645	S 114226	637	U 1164	208	S 119154	518	S 119273	520
S 108147	482	S 112515	645	S 114229	637	S 116M	197	S 119155	518	S 119274	520
S 108148	482	S 112516	645	S 114230	637	S 117018	322	S 119156	518	S 119275	520
S 108149	482	S 112520	645	S 114231	637	U 1170A	212	S 119157	518	S 119276	521
S 108150	482	S 112521	645	S 114232	637	U 1170M	212	S 119158	518	S 119277	521
S 108151	482	U 1126	208	S 114250	637	S 117102	312	S 119159	518	S 119278	521
S 108152	482	S 112600	598	S 114251	637	S 117104	312	S 119160	518	S 119279	521
S 108153	482	S 112601	598	S 114252	637	S 117106	312	S 119161	518	U 1192M	212
S 108154	482	S 112602	598	S 114253	637	S 117108	312	S 119162	518	U 1192MA	212
S 108156	482	S 112605	347	S 114254	637	S 117110	312	S 119163	518	U 1192MB	212
S 108157	482	S 112606	347	S 114255	637	S 117114	312	S 119164	518	U 1193	212
S 108499	484	S 112607	347	S 114256	637	S 117116	312	S 119165	518	S 119316	518
S 108500	484	S 112609	347	S 114257	637	S 117118	312	S 119166	518	S 119318	518
S 108501	484	S 112610	347	S 114258	637	S 117120	312	S 119167	518	S 119319	518
S 108502	484	S 112M	197	S 114259	637	S 117122	312	S 119168	518	S 119370	533
S 108503	484	U 1130	208	S 114300	640	S 117124	312	S 119169	518	S 119372	533
S 108504	484	U 1134	208	S 114301	640	S 117126	312	S 119170	518	S 119373	533
S 108505	484	S 113400	646	S 114351	640	S 117128	312	S 119171	518	S 119374	533
S 108506	484	S 113401	646	S 114352	640	S 117130	312	S 119172	518	S 119375	534
S 108507	484	S 113402	646	S 114353	640	S 117132	312	S 119173	518	S 119376	534
S 108508	484	S 113403	646	S 114354	640	S 117134	312	S 119181	518	S 119377	534
S 108510	486	S 113404	646	S 114355	640	S 117136	312	S 119182	518	U 1193M	212
S 108511	486	S 113405	646	S 114360	640	S 117138	312	S 119183	518	U 1194	212
S 108512	486	S 113406	646	S 114361	640	S 117140	312	S 119184	518	U 1194M	212
S 108513	486	S 113407	646	U 1145	208	S 117142	312	S 119191	518	U 1195	212
S 108514	486	S 113408	646	S 114M	197	S 117144	312	U 1191M	212	U 1195M	212
S 108515	486	S 113409	646	U 1150	208	S 117146	312	U 1192	212	U 1196	212
S 108527	486	S 113410	646	S 115054	304	S 117148	314	S 119204	517	U 1196M	212
S 108528	486	S 113411	646	S 115055	304	S 117150	314	S 119205	517	U 1197	212
S 108530	486	S 113412	646	S 115057	304	S 117152	314	S 119206	517	U 1197M	212
S 108M	197	S 113413	646	S 115058	304	S 117154	312	S 119208	517	S 119M	197
S 109M	197	S 113414	646	S 115063	304	S 117162	315	S 119209	517	U 11BA	684
U 10A	33	S 113415	646	S 115082	304	S 117164	315	S 119210	517	U 11BR	653
U 10B	33	S 113416	646	S 115083	304	S 117166	315	S 119211	517	U 11BZ	655
U 10BA	684	S 113417	646	S 115084	304	S 117170	315	S 119212	517	U 11CA	666
U 10BR	653	S 113418	646	S 115086	304	S 117193	312	S 119213	517	P 11CAP	658
U 10BZ	655	S 113419	646	S 115087	304	S 117194	310	S 119214	517	U 11CB	678
U 10CA	666	S 113420	646	S 115089	304	S 117520	515	S 119215	517	P 11CBP	679
P 10CAP	658	U 1135	208	S 115095	302	S 117522	515	S 119216	517	U 11CD	682
U 10CB	678	U 1139	208	S 115096	302	S 117524	515	S 119217	517	U 11CL	683
P 10CBP	679	S 113M	197	U 1151	208	S 117533	515	S 119218	517	U 11CN	669
U 10CD	682	U 1140	208	S 115110	306	S 117534	515	S 119219	517	U 11CP	688
U 10CL	683	S 114200	637	S 115111	306	S 117535	515	S 119220	517	U 11GA	671
U 10CN	669	S 114201	637	S 115112	306	S 117M	197	S 119221	517	U 11M4	211
U 10CP	688	S 114202	637	S 115115	306	U 1180	213	S 119250	520	U 11M6M	211
U 10GA	671	S 114203	637	S 115116	305	U 1180A	213	S 119251	520	U 11MA	676
U 10GP	690	S 114204	637	S 115117	305	U 1180M	213	S 119252	520	P 11MAP	677
U 10MA	676	S 114205	637	S 115118	305	U 1181	213	S 119253	520	U 11PE	693
P 10MAP	677	S 114206	637	S 115129	305	U 1181M	213	S 119254	520	U 11PO	681
U 10PE	693	S 114207	637	S 115138	282	U 1182	213	S 119255	520	P 11POP	681
U 10PO	681	S 114208	637	S 115139	282	U 1182M	213	S 119256	520	U 12000	269
P 10POP	681	S 114209	637	S 115140	282	U 1183	213	S 119257	520	U 12000X	269
S 110079	296	S 114210	637	S 115141	282	U 1183M	213	S 119258	520	U 12004	269
U 1100D	208	S 114211	637	S 115142	282	U 1184	213	S 119259	520	U 12004X	269
U 1100DM	208	S 114212	637	S 115143	282	U 1184M	213	S 119260	520	S 120050	553

ITEM	PAGE	ITEM	PAGE	ITEM	PAGE	ITEM	PAGE	ITEM	PAGE	ITEM	PAGE
S 120067	563	S 120227	564	S 120353	556	S 120745	NEW 543	S 121120	346	U 1214T	187
S 120068	563	S 120228	564	S 120354	556	S 120746	NEW 543	S 121121	573	U 1214V	328
S 120069	NEW 563	U 12024	269	S 120358	556	S 120747	NEW 543	S 121153	345	U 1214VM	328
U 120070M	190	S 120245	564	S 120360	556	S 120748	NEW 543	S 121154	345	U 1215M	190
U 12008	269	S 120246	564	S 120361	556	S 120749	NEW 543	S 121155	NEW 344	U 1215MA	196
U 120080	188	S 120247	564	S 120362	556	S 120750	543	S 121156	345	U 1215MB	198
U 120080A	193	S 120248	564	S 120363	556	S 120751	543	U 12116	194	U 1215MCM	203
U 12008X	269	S 120249	564	S 120368	557	S 120752	543	S 121162	347	U 1215MCMR	205
U 120090	193	S 120260	NEW 571	S 120369	557	S 120753	543	S 121164	NEW 347	U 1215MH	190
U 12009M	190	S 120264	571	S 120370	557	S 120754	543	S 121166	NEW 345	U 1215ML	192
U 12009S	188	S 120265	NEW 571	S 120371	557	S 120755	NEW 543	S 121167	345	U 1215MT	187
U 1200AL	192	S 120270	569	S 120372	557	S 120756	NEW 543	U 1211M	190	U 1215VM	328
U 1200AML	192	S 120271	NEW 569	S 120373	NEW 554	S 120757	NEW 542	U 1211MA	196	U 1216	188
U 1200BA	193	S 120275	569	S 120376	557	U 1207M	190	U 1211MB	198	U 1216A	193
U 1200BL	192	S 120276	NEW 569	S 120377	557	U 1207MA	196	U 1211MCM	203	U 1216B	198
U 1200BMA	196	S 120282	NEW 553	S 120378	557	U 1207MB	198	U 1211MCMR	205	U 1216CM	202
U 1200BML	192	S 120283	NEW 553	S 120381	557	U 1207MCM	203	U 1211MH	190	U 1216CMR	205
U 1200CA	193	S 120285	NEW 554	S 120382	557	U 1207MH	190	U 1211ML	192	U 1216H	188
U 1200CM	202	S 120286	NEW 554	S 120383	557	U 1207MT	187	U 1211MT	187	U 1216L	192
U 1200CMA	196	S 120287	NEW 554	S 120391	555	U 1208	188	U 1211VM	328	U 1216M	190
U 1200D	188	S 120288	NEW 554	S 120392	555	U 1208A	193	U 1212	188	U 1216MA	196
U 1200DA	193	S 120289	NEW 554	S 120393	555	U 1208CM	202	U 12120	194	U 1216MB	198
U 1200DH	188	S 120290	NEW 554	S 120394	555	U 1208H	188	U 12124	194	U 1216MCM	203
U 1200DHM	190	S 120291	NEW 554	S 120399	NEW 557	U 1208M	190	U 12128	194	U 1216MH	190
U 1200F	188	S 120292	NEW 554	U 1203CF	NEW 188	U 1208MA	196	U 1212A	193	U 1216ML	192
U 1200FA	193	S 120293	NEW 554	S 120404	NEW 541	U 1208MB	198	U 1212B	198	U 1216MT	187
U 1200FB	198	S 120294	NEW 553	S 120405	NEW 541	U 1208MCM	203	U 1212CM	202	U 1216T	187
U 1200FC	187	S 120295	NEW 553	S 120414	NEW 541	U 1208MH	190	U 1212CMR	205	U 1216V	328
U 1200FHD	193	S 120296	NEW 554	S 120415	NEW 541	U 1208MT	187	U 1212H	188	U 1217M	190
U 1200FM	190	S 120297	NEW 554	S 120416	NEW 541	U 1208T	187	U 1212L	192	U 1217MA	196
U 1200FMA	196	S 120298	NEW 554	S 120418	NEW 542	S 120900	NEW 564	U 1212M	190	U 1217MB	198
U 1200FMB	198	U 1202CM	202	S 120419	NEW 542	U 1209M	190	U 1212MA	196	U 1217MCM	203
U 1200G	188	U 1202MCM	203	S 120431	NEW 542	U 1209MA	196	U 1212MB	198	U 1217MH	190
U 1200GA	193	U 1202TF	NEW 188	S 120432	NEW 542	U 1209MB	198	U 1212MCM	203	U 1217ML	192
U 1200H	188	S 120301	555	S 120433	NEW 542	U 1209MCM	203	U 1212MCMR	205	U 1217MT	187
U 1200HB	198	S 120302	555	U 1204CF	NEW 188	U 1209MH	190	U 1212MH	190	U 1217VM	328
U 1200HM	190	S 120303	555	S 120501	297	U 1209MT	187	U 1212ML	192	U 1218	188
U 1200I	188	S 120304	555	S 120530	552	S 120M	NEW 197	U 1212MT	187	U 1218A	193
U 1200IM	190	S 120306	NEW 553	S 120550	550	U 1210	188	U 1212T	187	U 1218B	198
U 1200J	188	S 120311	555	S 120556	550	S 121023	342	U 1212V	328	U 1218CM	202
U 1200JM	190	S 120312	555	S 120561	550	S 121024	342	U 1212VM	328	U 1218CMR	205
U 1200KM	190	S 120313	555	S 120562	550	U 12104	194	U 1213M	190	U 1218H	188
U 1200MCM	203	S 120314	555	S 120563	550	S 121056	348	U 1213MA	196	U 1218L	192
U 1200MT9	187	U 12031X	269	U 1205CF	NEW 188	U 12108	194	U 1213MB	198	U 1218M	190
U 1200MT9A	187	U 12032	269	U 12061X	269	U 1210A	193	U 1213MCM	203	U 1218MA	196
U 1200QM	190	S 120320	557	U 12062	269	U 1210B	198	U 1213MCMR	205	U 1218MB	198
U 1200QMA	196	S 120321	557	U 12062X	269	U 1210CM	202	U 1213MH	190	U 1218MCM	203
U 1200T6	187	S 120322	557	U 12063X	269	U 1210CMR	205	U 1213ML	192	U 1218MH	190
U 1200T9	187	U 12032X	269	U 1206M	190	U 1210H	188	U 1213MT	187	U 1218ML	192
S 120127	546	S 120330	556	U 1206MCM	203	U 1210M	190	U 1213VM	328	U 1218MT	187
S 120128	401	S 120331	556	U 1206TF	NEW 190	U 1210MA	196	U 1214	188	U 1218T	187
U 12016	269	S 120332	556	S 120731	NEW 543	U 1210MB	198	U 1214A	193	U 1218V	328
U 12016X	269	S 120333	556	S 120732	NEW 543	U 1210MCM	203	U 1214B	198	U 1218VM	328
U 1201CM	202	S 120334	556	S 120733	NEW 543	U 1210MCMR	205	U 1214CM	202	U 1219M	190
U 1201MCM	203	S 120335	556	S 120734	NEW 543	U 1210MH	190	U 1214CMR	205	U 1219MA	196
U 1201MT6	187	S 120338	NEW 554	S 120735	NEW 543	U 1210ML	192	U 1214H	188	U 1219MB	198
U 1201T6	187	U 12033X	269	S 120736	NEW 543	U 1210MT	187	U 1214L	192	U 1219MCM	203
U 1201TF	NEW 188	S 120340	556	S 120737	NEW 543	U 1210T	187	U 1214M	190	U 1219MH	190
U 1201V	NEW 328	S 120341	556	S 120738	NEW 543	U 1210V	328	U 1214MA	196	U 1219ML	192
U 1201VM	NEW 328	S 120342	556	S 120739	NEW 543	U 1210VM	328	U 1214MB	198	U 1219MT	187
U 12020	269	S 120343	556	S 120740	NEW 543	S 121100	NEW 343	U 1214MCM	203	U 1219VM	328
S 120205	564	S 120344	556	S 120741	NEW 543	S 121110	345	U 1214MCMR	205	S 121M	197
S 120206	564	S 120350	556	S 120742	NEW 543	S 121111	NEW 344	U 1214MH	190	U 1220	188
U 12020X	269	S 120351	556	S 120743	NEW 543	S 121114	NEW 345	U 1214ML	192	S 122090	NEW 696
S 120226	564	S 120352	556	S 120744	NEW 543	U 12112	194	U 1214MT	187	U 1220A	193

# 28 NUMERICAL INDEX

ITEM	PAGE	ITEM	PAGE	ITEM	PAGE	ITEM	PAGE	ITEM	PAGE	ITEM	PAGE
U 1220B	198	U 1222MB	198	U 1230H	188	U 1232B	198	S 123500	558	S 123819	559
U 1220CM	202	U 1222MCM	203	U 1230L	192	U 1232CM	202	S 123502	558	S 123820	559
U 1220CMR	205	U 1222T	187	U 1230M	190	U 1232H	188	S 123504	558	S 123821	559
U 1220H	188	U 1222V	328	U 1230MA	196	U 1232L	192	S 123505	558	S 123822	559
U 1220L	192	U 1223M	190	U 1230MB	198	U 1232M	190	S 123508	558	S 123823	559
U 1220M	190	U 1223MA	196	U 1230MCM	203	U 1232MA	196	S 123509	558	S 123824	559
U 1220MA	196	U 1223MB	198	S 123101	597	U 1232MCM	203	S 123510	558	S 123825	559
U 1220MB	198	U 1224	188	S 123102	597	S 123310 <small>NEW</small>	600	S 123511	558	S 123826	559
U 1220MCM	203	U 1224A	193	S 123103	597	S 123311 <small>NEW</small>	600	S 123512	558	S 123827	559
U 1220ML	192	U 1224B	198	S 123104	597	S 123312 <small>NEW</small>	600	S 123513	558	S 123831	559
U 1220T	187	U 1224CM	202	S 123105	597	S 123313 <small>NEW</small>	600	S 123514	558	S 123832	559
U 1220V	328	U 1224CMR	205	S 123106	597	S 123314 <small>NEW</small>	600	S 123515	558	S 123833	559
S 122100	442	U 1224H	188	S 123108	596	S 123315 <small>NEW</small>	600	S 123516	558	S 123834	559
S 122101	442	U 1224L	192	S 123110	596	S 123316 <small>NEW</small>	600	S 123517	558	S 123835	559
S 122102	442	U 1224M	190	S 123112	596	S 123317 <small>NEW</small>	600	S 123518	558	S 123836	559
S 122103	442	U 1224MA	196	S 123132	600	S 123318 <small>NEW</small>	600	S 123519	558	S 123837	559
S 122104	442	U 1224MB	198	S 123133	600	S 123340	601	S 123520	558	S 123838	559
S 122105	442	U 1224MCM	203	S 123135	600	S 123341	601	S 123521	558	S 123839	559
S 122106	442	U 1225M	190	S 123136	600	S 123342	601	S 123522	558	S 123840	559
S 122110	442	U 1225MA	196	S 123137	600	S 123343 <small>NEW</small>	601	S 123523	558	S 123860	559
S 122121	442	U 1225MB	198	S 123138	600	S 123344 <small>NEW</small>	601	S 123528	558	S 123861	559
S 122122	442	U 1225MCM	203	S 123147 <small>NEW</small>	595	S 123345 <small>NEW</small>	601	S 123554	558	S 123862	559
S 122123	442	U 1225V	328	S 123160	596	S 123346 <small>NEW</small>	601	S 123558	558	S 123863	559
S 122124	442	U 1226	188	S 123180	598	S 123347	602	S 123560	558	S 123864	559
U 1221M	190	U 1226A	193	S 123181	598	S 123349	600	S 123562	558	S 123865	559
U 1221MA	196	U 1226B	198	S 123182	598	S 123350	600	S 123564	558	S 123880	559
U 1221MB	198	U 1226CM	202	S 123183	598	S 123351	600	S 123566	558	S 123881	559
U 1221MCM	203	U 1226H	188	S 123184	598	S 123352	600	S 123570	558	S 123882	559
U 1221ML	192	U 1226L	192	S 123185	598	S 123353	600	S 123572	558	S 123883	559
U 1222	188	U 1226M	190	S 123186	598	S 123354 <small>NEW</small>	602	U 1236	188	S 123884	559
U 122200	433	U 1226MA	196	S 123187	598	S 123356	601	S 123600	559	U 1238A	193
S 122201 <small>NEW</small>	434	U 1226MB	198	S 123188	598	S 123357 <small>NEW</small>	601	S 123601	559	U 1238B	198
S 122202	434	U 1227M	190	S 123189	597	S 123361	600	S 123602	559	U 1238M	190
S 122203	434	U 1227MA	196	S 123190	597	S 123377 <small>NEW</small>	600	S 123603	559	U 1238MA	196
S 122204 <small>NEW</small>	433	U 1227MB	198	S 123191	597	S 123378 <small>NEW</small>	600	S 123604	559	S 123900	559
S 122206 <small>NEW</small>	434	U 1227MCM	203	S 123192	597	S 123379 <small>NEW</small>	600	S 123605	559	S 123901	559
S 122210	441	U 1228	188	S 123193	597	S 123380	601	S 123606	559	S 123902	559
S 122211	441	U 1228A	193	S 123194	599	S 123381	601	S 123607	559	S 123903	559
S 122230 <small>NEW</small>	433	U 1228B	198	S 123195	599	S 123382	601	U 1236A	193	S 123904	559
S 122250	441	U 1228CM	202	S 123197	597	S 123383	601	U 1236B	198	S 123905	559
S 122251	441	U 1228H	188	S 123198	597	S 123384 <small>NEW</small>	601	U 1236CM	202	S 123906	559
S 122252	441	U 1228L	192	U 1232	188	S 123385 <small>NEW</small>	601	U 1236M	190	S 123910	353
S 122253	441	U 1228M	190	S 123202	596	S 123386 <small>NEW</small>	601	U 1236MA	196	S 123911	353
S 122254	440	U 1228MA	196	S 123203	596	S 123387 <small>NEW</small>	601	U 1236MB	198	S 123M	197
S 122255 <small>NEW</small>	440	U 1228MB	198	S 123205	596	S 123388	601	U 1236MCM	203	U 1240	188
S 122257	440	U 1229M	190	S 123206	596	S 123389	601	S 123701	559	U 1240A	193
S 122258	440	U 1229MA	196	S 123208	596	S 123390 <small>NEW</small>	601	S 123702	558	U 1240B	198
S 122264	441	U 1229MB	198	S 123259	541	S 123391 <small>NEW</small>	601	U 1237M	190	U 1240CM	202
S 122265	440	S 122M	197	S 123260	541	S 123392	601	U 1237MA	196	S 124128	703
S 122268	439	U 1230	188	S 123261	541	S 123393	601	U 1238	188	S 124129	703
S 122269	439	S 123022	596	S 123262	541	S 123394	601	S 123802	559	S 124130	703
S 122270	439	S 123023	596	S 123263	541	S 123395	601	S 123803	559	S 124189 <small>NEW</small>	93
S 122275	589	S 123032	596	S 123270	593	S 123396 <small>NEW</small>	601	S 123804	559	S 124190 <small>NEW</small>	93
S 122276	589	S 123033	596	S 123271	593	S 123397 <small>NEW</small>	601	S 123805	559	U 1241M	190
S 122277	589	S 123034	596	S 123272	593	S 123398 <small>NEW</small>	601	S 123806	559	U 1241MA	196
S 122280	441	S 123035	596	S 123273	593	S 123399 <small>NEW</small>	601	S 123807	559	U 1242	188
S 122281	441	S 123036	596	S 123274 <small>NEW</small>	593	U 1233M	190	S 123808	559	U 1242A	193
U 1222A	193	S 123081	597	S 123275 <small>NEW</small>	593	U 1233MA	196	S 123809	559	U 1242B	198
U 1222B	198	S 123082	597	S 123276 <small>NEW</small>	593	U 1234	188	S 123810	559	U 1242CM	202
U 1222CM	202	S 123083	597	S 123278	541	U 1234A	193	S 123811	559	U 1242M	190
U 1222CMR	205	S 123092	597	S 123279	541	U 1234B	198	S 123813	559	U 1242MA	196
U 1222H	188	S 123093	597	S 123297 <small>NEW</small>	601	U 1234CM	202	S 123815	559	U 1244	188
U 1222L	192	U 1230A	193	S 123298 <small>NEW</small>	601	U 1234M	190	S 123816	559	S 124400 <small>NEW</small>	92
U 1222M	190	U 1230B	198	S 123299 <small>NEW</small>	601	U 1234MA	196	S 123817	559	S 124401 <small>NEW</small>	92
U 1222MA	196	U 1230CM	202	U 1232A	193	U 1234MCM	203	S 123818	559	S 124403 <small>NEW</small>	92

ITEM	PAGE	ITEM	PAGE	ITEM	PAGE	ITEM	PAGE	ITEM	PAGE	ITEM	PAGE
124408	623	1270-11M	199	1294	194	130333	577	130553	575	1312P	319
1244A	193	1270-12	199	1294I <small>NEW</small>	195	130334	577	130554	575	1312PN	319
1244CM	202	1270-12M	199	1296	194	130335	579	130561	444	1316FV	319
1246	188	1270-13M	199	1296I <small>NEW</small>	195	130336	579	130562	444	1316HD	319
1246A	193	1270-14	199	1298	194	130337	579	130567 <small>NEW</small>	589	1316P	319
1246B	198	1270-14M	199	1299	194	130338	579	130568 <small>NEW</small>	589	1316PN	319
1246CM	202	1270-15M	199	129M <small>NEW</small>	197	130340	580	130569	444	132050	567
1246M	190	1270-16	199	12CA	666	130341	580	130570	444	132051	567
1246MA	196	1270-16M	199	12CAP <small>NEW</small>	658	130342	580	130575	444	132052	567
1248	188	1270-17M	199	12CB	678	130344 <small>NEW</small>	580	13058	272	132053	567
1248A	193	1270-18	199	12CD <small>NEW</small>	682	130345 <small>NEW</small>	580	130585 <small>NEW</small>	567	1320HD	319
1248B	198	1270-18M	199	12CE	677	130346 <small>NEW</small>	580	130587 <small>NEW</small>	567	1324AF	319
124M <small>NEW</small>	197	1270-19M	199	12CN	669	130347 <small>NEW</small>	578	13058X	272	1324E	320
1250	188	1270-20	199	12CP	688	130348	580	130590 <small>NEW</small>	567	1324FV	319
1250A	193	1270-22	199	12GA	672	130349	580	130592 <small>NEW</small>	567	1324FVS	319
1250M	190	1270-24	199	12GP	690	130360	581	130594 <small>NEW</small>	566	1324HD	319
1250MA	196	1270HF	199	12MA	676	130362	581	130595 <small>NEW</small>	566	1324P	319
125100 <small>NEW</small>	90	1270HMF	199	12MAP <small>NEW</small>	677	130363	581	130596 <small>NEW</small>	567	1324PN	319
125106 <small>NEW</small>	90	1270I <small>NEW</small>	195	12MF12M	204	130370	579	130597 <small>NEW</small>	566	1326DB	320
125107 <small>NEW</small>	66	1270M	196	12MF7	201	130371	579	130598 <small>NEW</small>	568	132M <small>NEW</small>	197
125108 <small>NEW</small>	73	1270MI <small>NEW</small>	197	12MF7M	201	130372	579	130600	591	1332E	320
125109 <small>NEW</small>	90	127194 <small>NEW</small>	696	12MF8	204	130373	579	130601	591	1332FV	319
125111 <small>NEW</small>	66	127195	696	12MR7	200	130374	579	130602	592	1332FVS	319
125113	89	1272	194	12MR7M	201	130375	580	130603	592	1332HD	319
125114	89	1272I <small>NEW</small>	195	12MS7	200	130376	579	130604	591	1332P	319
125115	89	1273M	196	12MS7M	200	130377	579	130605	590	1332PN	319
1251M	190	1274	194	12PE	693	130378	580	130606	590	1336DB	320
1251MA	196	1274I <small>NEW</small>	195	12PO	681	130379	579	130607	590	1340FV	319
1252	188	1275M	196	12POP <small>NEW</small>	681	130380	579	130620	591	1340P	319
1252A	193	1275MI <small>NEW</small>	197	12S	320	130381	580	130621	591	1340PN	319
1252B	198	1276	194	130008	593	130382	579	130622	591	1344DB	320
1254	188	1276I <small>NEW</small>	195	130010	593	130383	579	130623	591	1348HD	319
125412 <small>NEW</small>	38	1278	194	130038	588	130384	579	130624	591	1348P	319
1254A	193	1278I <small>NEW</small>	195	130039	588	130400	576	130625	590	1348PN	319
1254B	198	127MI <small>NEW</small>	197	130055 <small>NEW</small>	574	130404	576	130626	590	136010	420
1255M	196	1280	194	130080 <small>NEW</small>	589	130408	576	130627	590	136011	420
1255MI <small>NEW</small>	197	128002 <small>NEW</small>	561	130225	569	130409	576	130628	590	136012	420
1256	188	128004 <small>NEW</small>	561	130226	572	130494	571	130630	592	136013	421
1256A	193	128005 <small>NEW</small>	561	130227	572	130495	571	130631	592	136014	421
1256B	198	128006 <small>NEW</small>	561	130229	571	130496	571	130650	568	1362	321
1258	188	128007 <small>NEW</small>	561	130230 <small>NEW</small>	575	130497	571	130651	568	1362T	321
1258A	193	128010 <small>NEW</small>	561	130231 <small>NEW</small>	575	130498 <small>NEW</small>	571	130653	568	1362XS	321
1258B	198	128011 <small>NEW</small>	561	130232 <small>NEW</small>	575	130499 <small>NEW</small>	571	130654	568	1363	321
125M <small>NEW</small>	197	128030 <small>NEW</small>	561	130233 <small>NEW</small>	575	130500 <small>NEW</small>	571	130656	568	1363T	321
1260	188	128032 <small>NEW</small>	561	130239	575	130501	571	130657	568	1363XS	321
1260A	193	128033 <small>NEW</small>	561	130298	577	130502	571	130657	566	1364	321
1260B	198	128050 <small>NEW</small>	560	130299	577	130503	571	130672	566	1364T	321
1260M	196	128053 <small>NEW</small>	560	130312 <small>NEW</small>	578	130504	571	130674	566	1364XS	321
1260MI <small>NEW</small>	197	128054 <small>NEW</small>	560	130314 <small>NEW</small>	578	130505	571	130676	566	1366	323
126246 <small>NEW</small>	701	128060	560	130315 <small>NEW</small>	578	130506	571	130680	591	1367	323
126287	699	1280I <small>NEW</small>	195	130316 <small>NEW</small>	578	130507	571	130681	591	1368	323
1264	188	1280M	196	130317	577	130508	571	130682	591	136850	634
126445 <small>NEW</small>	627	1282	194	130318	577	130511 <small>NEW</small>	571	130684	591	136851	634
126448	439	1282I <small>NEW</small>	195	130319	577	130512 <small>NEW</small>	571	130688	592	136852	634
1264A	193	1284	194	130320	577	130513 <small>NEW</small>	571	130689	592	136853	634
1264B	198	1284I <small>NEW</small>	195	130321	577	130514 <small>NEW</small>	571	130701	575	136854	634
1265M	196	1286	194	130322	577	130515 <small>NEW</small>	571	130703	575	136855	634
1265MI <small>NEW</small>	197	1286I <small>NEW</small>	195	130323 <small>NEW</small>	578	130516 <small>NEW</small>	571	130704	575	1368B	323
1266	194	1288	194	130324 <small>NEW</small>	578	130517 <small>NEW</small>	571	130705	575	1368G	323
1266I <small>NEW</small>	195	1288I <small>NEW</small>	195	130325 <small>NEW</small>	578	130518 <small>NEW</small>	571	1308FV	319	137050	392
1268	194	128MI <small>NEW</small>	197	130326	579	13054	272	1308P	319	137052	412
1268I <small>NEW</small>	195	1290	194	130327	579	13054X	272	1308PN	319	137053	412
126M <small>NEW</small>	197	1290I <small>NEW</small>	195	130329 <small>NEW</small>	578	130550 <small>NEW</small>	566	130M <small>NEW</small>	197	137067	398
1270	194	1292	194	130330 <small>NEW</small>	578	130551	575	131000	646	137068	398
1270-10M	199	1292I <small>NEW</small>	195	130332 <small>NEW</small>	578	130552	575	1312FV	319	137069	398

# 28 NUMERICAL INDEX

ITEM	PAGE	ITEM	PAGE	ITEM	PAGE	ITEM	PAGE	ITEM	PAGE	ITEM	PAGE
\$ 137070	398	\$ 137423 <small>NEW</small>	614	\$ 137529 <small>NEW</small>	621	\$ 137615 <small>NEW</small>	620	\$ 137826 <small>NEW</small>	641	\$ 138110 <small>NEW</small>	644
\$ 137071	397	\$ 137424 <small>NEW</small>	614	\$ 137530 <small>NEW</small>	621	\$ 137616 <small>NEW</small>	620	\$ 137827 <small>NEW</small>	641	\$ 138111 <small>NEW</small>	644
\$ 137073	399	\$ 137425 <small>NEW</small>	614	\$ 137531 <small>NEW</small>	621	\$ 137617 <small>NEW</small>	620	\$ 137828 <small>NEW</small>	641	\$ 138112 <small>NEW</small>	644
\$ 137074	397	\$ 137426 <small>NEW</small>	614	\$ 137532 <small>NEW</small>	621	\$ 137618 <small>NEW</small>	620	\$ 137999	639	\$ 138113 <small>NEW</small>	644
\$ 137079	397 y 704	\$ 137427 <small>NEW</small>	614	\$ 137533 <small>NEW</small>	620	\$ 137619 <small>NEW</small>	621	\$ 138000	639	\$ 138114 <small>NEW</small>	644
\$ 137110 <small>NEW</small>	408	\$ 137430 <small>NEW</small>	615	\$ 137534 <small>NEW</small>	620	\$ 137620 <small>NEW</small>	607	\$ 138001	639	\$ 138115 <small>NEW</small>	644
\$ 137111 <small>NEW</small>	408	\$ 137431 <small>NEW</small>	615	\$ 137535 <small>NEW</small>	620	\$ 137621 <small>NEW</small>	607	\$ 138002	639	\$ 138116 <small>NEW</small>	644
\$ 137112 <small>NEW</small>	408	\$ 137432 <small>NEW</small>	616	\$ 137536 <small>NEW</small>	620	\$ 137622 <small>NEW</small>	607	\$ 138004	639	\$ 138117 <small>NEW</small>	644
\$ 137120 <small>NEW</small>	408	\$ 137440 <small>NEW</small>	614	\$ 137537 <small>NEW</small>	621	\$ 137623 <small>NEW</small>	607	\$ 138005	639	\$ 138118 <small>NEW</small>	644
\$ 137212 <small>NEW</small>	414	\$ 137441 <small>NEW</small>	614	\$ 137538 <small>NEW</small>	619	\$ 137650	623	\$ 138006	639	\$ 138119 <small>NEW</small>	644
\$ 137213 <small>NEW</small>	414	\$ 137442 <small>NEW</small>	614	\$ 137539 <small>NEW</small>	619	\$ 137651	623	\$ 138007	639	\$ 138200	453
\$ 137214 <small>NEW</small>	414	\$ 137443 <small>NEW</small>	614	\$ 137540 <small>NEW</small>	619	\$ 137652	623	\$ 138008	639	\$ 138201	453
\$ 137215 <small>NEW</small>	414	\$ 137459	632	\$ 137541 <small>NEW</small>	619	\$ 137653	618	\$ 138009	639	\$ 138202	453
\$ 137222 <small>NEW</small>	416	\$ 137461	632	\$ 137542 <small>NEW</small>	619	\$ 137660	609	\$ 138010	639	\$ 138203	453
\$ 137223	416	\$ 137462	632	\$ 137543 <small>NEW</small>	618	\$ 137661	609	\$ 138011	639	\$ 138204	453
\$ 137224 <small>NEW</small>	417	\$ 137463 <small>NEW</small>	632	\$ 137544 <small>NEW</small>	618	\$ 137662	609	\$ 138012	639	\$ 138205	453
\$ 137225 <small>NEW</small>	418	\$ 137464 <small>NEW</small>	632	\$ 137545 <small>NEW</small>	618	\$ 137668 <small>NEW</small>	609	\$ 138013	639	\$ 138206	453
\$ 137305	611	\$ 137481 <small>NEW</small>	630	\$ 137546 <small>NEW</small>	618	\$ 137669 <small>NEW</small>	609	\$ 138014	639	\$ 138207	453
\$ 137308 <small>NEW</small>	607	\$ 137482 <small>NEW</small>	630	\$ 137547 <small>NEW</small>	618	\$ 137670 <small>NEW</small>	609	\$ 138015 <small>NEW</small>	638	U 1383	320
\$ 137309 <small>NEW</small>	607	\$ 137483 <small>NEW</small>	630	\$ 137548 <small>NEW</small>	617	\$ 137676	610	\$ 138017 <small>NEW</small>	638	U 1383A	320
\$ 137310 <small>NEW</small>	607	\$ 137484 <small>NEW</small>	630	\$ 137549 <small>NEW</small>	617	\$ 137677	610	\$ 138018 <small>NEW</small>	638	U 1383FV	320
\$ 137311 <small>NEW</small>	607	\$ 137485 <small>NEW</small>	630	\$ 137550	631	\$ 137678	610	\$ 138020 <small>NEW</small>	638	U 13CA	658
\$ 137312 <small>NEW</small>	607	\$ 137486 <small>NEW</small>	630	\$ 137551	631	\$ 137684	610	\$ 138022 <small>NEW</small>	638	U 13CB	678
\$ 137313 <small>NEW</small>	607	\$ 137487 <small>NEW</small>	630	\$ 137552	631	\$ 137700	636	\$ 138024	638	U 13CE	677
\$ 137320	611	\$ 137488 <small>NEW</small>	630	\$ 137553	631	\$ 137701	636	\$ 138025	638	U 13CL	683
\$ 137321	606	\$ 137489 <small>NEW</small>	630	\$ 137554	631	\$ 137702	636	\$ 138026	638	U 13CN	669
\$ 137323	610	\$ 137490 <small>NEW</small>	630	\$ 137555	631	\$ 137703	636	\$ 138030	602	U 13CP	688
\$ 137324	610	\$ 137491	618	\$ 137556	631	\$ 137704	636	\$ 138031	602	U 13GA	672
\$ 137325	610	\$ 137492	618	\$ 137557	631	\$ 137705	636	\$ 138032	602	U 13MA	676
\$ 137326	610	\$ 137493	618	\$ 137558	631	\$ 137706	636	\$ 138033	602	P 13MAP <small>NEW</small>	677
\$ 137327 <small>NEW</small>	606	\$ 137494 <small>NEW</small>	618	\$ 137559	631	\$ 137707	636	\$ 138034	602	U 13PE	693
\$ 137328 <small>NEW</small>	606	\$ 137495 <small>NEW</small>	618	\$ 137560	631	\$ 137708	636	\$ 138036	638	U 13PO	681
\$ 137331 <small>NEW</small>	606	\$ 137496 <small>NEW</small>	617	\$ 137561	631	\$ 137709	636	\$ 138037	638	P 13POP <small>NEW</small>	681
\$ 137334	606	\$ 137497 <small>NEW</small>	617	\$ 137562	631	\$ 137710	636	\$ 138038	638	U 14008X	268
\$ 137337	605	\$ 137498	618	\$ 137563	631	\$ 137711	636	\$ 138040	637	U 14012	268
\$ 137345	612	\$ 137499	618	\$ 137564	631	\$ 137712	636	\$ 138041	637	U 14012X	268
\$ 137347	612	\$ 137500 <small>NEW</small>	619	\$ 137565	631	\$ 137713	636	\$ 138042	637	U 14016	268
\$ 137367	631	\$ 137501 <small>NEW</small>	619	\$ 137566	631	\$ 137714	636	\$ 138046	638	U 14016X	268
\$ 137368	631	\$ 137502 <small>NEW</small>	619	\$ 137567	631	\$ 137715	636	\$ 138049	640	U 14020	268
\$ 137369	631	\$ 137503 <small>NEW</small>	619	\$ 137568	631	\$ 137716	636	\$ 138050	640	U 14020X	268
\$ 137372 <small>NEW</small>	606	\$ 137504 <small>NEW</small>	619	\$ 137569	631	\$ 137717	636	\$ 138052	640	U 14024	268
\$ 137373 <small>NEW</small>	606	\$ 137505 <small>NEW</small>	619	\$ 137570	631	\$ 137718	636	\$ 138053	640	U 1410	321
\$ 137374 <small>NEW</small>	606	\$ 137506 <small>NEW</small>	619	\$ 137577 <small>NEW</small>	630	\$ 137720	636	\$ 138054	640	U 1421	322 y 372
\$ 137375 <small>NEW</small>	618	\$ 137507 <small>NEW</small>	619	\$ 137578 <small>NEW</small>	630	\$ 137722	636	\$ 138055	640	U 1424	322 y 372
\$ 137376 <small>NEW</small>	618	\$ 137508 <small>NEW</small>	619	\$ 137579 <small>NEW</small>	630	\$ 137724 <small>NEW</small>	636	\$ 138056	640	U 1424FV	322 y 372
\$ 137377	618	\$ 137509 <small>NEW</small>	619	\$ 137580 <small>NEW</small>	630	\$ 137726 <small>NEW</small>	636	\$ 138057	640	U 1427	322 y 372
\$ 137378	618	\$ 137510 <small>NEW</small>	630	\$ 137581 <small>NEW</small>	630	\$ 137728 <small>NEW</small>	636	\$ 138058	640	U 1427FV	322 y 372
\$ 137380	625	\$ 137511 <small>NEW</small>	630	\$ 137582 <small>NEW</small>	630	\$ 137790	641	\$ 138059	640	U 1428	322 y 372
\$ 137382 <small>NEW</small>	625	\$ 137512 <small>NEW</small>	630	\$ 137583 <small>NEW</small>	630	\$ 137791	641	\$ 138060	631	U 1428FV	322 y 372
\$ 137383 <small>NEW</small>	625	\$ 137513 <small>NEW</small>	630	\$ 137584 <small>NEW</small>	630	\$ 137792	641	\$ 138061	631	U 1430	318
\$ 137385	626	\$ 137514 <small>NEW</small>	630	\$ 137585 <small>NEW</small>	630	\$ 137793	641	\$ 138062	631	U 1430FV	318
\$ 137386	626	\$ 137515 <small>NEW</small>	630	\$ 137586 <small>NEW</small>	630	\$ 137794	641	\$ 138080 <small>NEW</small>	602 y 639	U 1432	318
\$ 137387 <small>NEW</small>	625	\$ 137516 <small>NEW</small>	630	\$ 137587 <small>NEW</small>	630	\$ 137795	641	\$ 138081 <small>NEW</small>	602 y 639	U 1432FV	318
\$ 137388	626	\$ 137517 <small>NEW</small>	630	\$ 137588 <small>NEW</small>	630	\$ 137796	641	\$ 138082 <small>NEW</small>	602 y 639	U 1433A	316
\$ 137389	626	\$ 137518 <small>NEW</small>	630	\$ 137589 <small>NEW</small>	617	\$ 137797	641	\$ 138083 <small>NEW</small>	602 y 639	U 1433EG	317
\$ 137390	626	\$ 137519 <small>NEW</small>	630	\$ 137591 <small>NEW</small>	617	\$ 137798	641	\$ 138084 <small>NEW</small>	602 y 639	U 1433G	317
\$ 137397	628	\$ 137520 <small>NEW</small>	621	\$ 137592 <small>NEW</small>	617	\$ 137799	641	\$ 138100 <small>NEW</small>	644	U 1433GFV	317
\$ 137398	628	\$ 137521	621	\$ 137593 <small>NEW</small>	617	\$ 137800	641	\$ 138101 <small>NEW</small>	644	U 1434A	316
\$ 137399	628	\$ 137522	621	\$ 137600	632	\$ 137801	641	\$ 138102 <small>NEW</small>	644	U 1434AF <small>NEW</small>	316
\$ 137406	628	\$ 137523	621	\$ 137601 <small>NEW</small>	632	\$ 137820 <small>NEW</small>	641	\$ 138104 <small>NEW</small>	644	U 1434EG	317
\$ 137412	625	\$ 137524	621	\$ 137605 <small>NEW</small>	632	\$ 137821 <small>NEW</small>	641	\$ 138105 <small>NEW</small>	644	U 1434G	317
\$ 137413	625	\$ 137525	620	\$ 137611 <small>NEW</small>	621	\$ 137822 <small>NEW</small>	641	\$ 138106 <small>NEW</small>	644	U 1434GFV	317
\$ 137420 <small>NEW</small>	614	\$ 137526	620	\$ 137612 <small>NEW</small>	621	\$ 137823 <small>NEW</small>	641	\$ 138107 <small>NEW</small>	644	U 1435A	316
\$ 137421 <small>NEW</small>	614	\$ 137527	620	\$ 137613 <small>NEW</small>	621	\$ 137824 <small>NEW</small>	641	\$ 138108 <small>NEW</small>	644	U 1435AF <small>NEW</small>	316
\$ 137422 <small>NEW</small>	614	\$ 137528	620	\$ 137614 <small>NEW</small>	621	\$ 137825 <small>NEW</small>	641	\$ 138109 <small>NEW</small>	644	U 1435EG	317



ITEM	PAGE	ITEM	PAGE	ITEM	PAGE	ITEM	PAGE	ITEM	PAGE	ITEM	PAGE
U1435G	317	U15068	178	S151212	371	U16040X	270	U1885CR	540	U2120	308
U1435GFV	317	U15072	178	S151230	371	U1616HD	321	U1885CSS	540	U2124	308
U1435HD	316	U15074	178	S151252	460	U16308	271	U189	332	U2125	308
U1436DB	318	U15080	178	S151253	460	U16308X	270	U18CA	664	U2126	308
U1436G	317	S150830	636	S151254	460	U16310	271	U18CL	683	U2126G	287
U1436GFV	317	S150831	636	S151260	460	U16310X	270	U18CT55M	535	U2130	308
U1437G	317	S150832	636	S151261	460	U16315	271	U18MA	675	U2130HD	308
U1437GFV	317	S150833	636	S151500	447	U16315X	270	U18PO	681	U217	375
U1437HD	316	S150834	636	S151501	447	U16320	271	P18POP NEW	681	U21CA	670
U1438G	317	S150836	446	S151502	447	U16320X	270	U190	295	U21MA	675
U1438GFV	317	S150837	446	S151503	447	U16325	271	U192	295	U21PO	680
U1439DB	318	S150838	446	S151520	447	U16325X	270	U194	412	U220G	290
U1439G	317	S150839	446	S151521	447	U16327X	270	U195	412	U2210	383
U1439GFV	317	S150840	446	S151522	447	U16330	271	U196	412	U2260	414
U1439HD	316	S150843	636	S151523	447	U16330X	270	U19CA	656	U2261	414
U1440G	317	S150844	636	S151524	447	U16340	271	U19CL	683	U2264	414
U1440GFV	317	S150845	636	S151525	447	U16610X	270	U19MA	675	U2265	414
U1441HD	316	S150847	447	S151530	452	U16615	271	U19PO	680	U2266	414
U1442HD	316	S150848	447	S151531	452	U16615X	270	U1RB	393	U2267	414
U1456	371	S150849	447	S151532	452	U16620X	270	U200	395	U226G	290
U14CA	658	S150850	447	S151533	452	U16625	271	U20004	276	U226GI	291
U14CB	678	S150851	447	S151535	452	U16625X	270	U20008	276	U226GR	290
U14CE	677	S150852	447	S151536	452	U16627X	270	U20012	276	U226GRX	288
U14CL	683	S150853	447	S151537	452	U16630	271	U20040	276	U226GS	290
U14CN	669	S150854	447	S151538	452	U16630X	270	U2006	375	U226GX	288
U14CP	688	S150857	446	U15201	177	U16640X	270	U2007	375	U227G	290
U14GA	672	S150858	446	U15201H	156	U16CA	665	U200A	395	U2292G	290
U14GP	690	S150859	446	U15670	181	U16CE	677	U2010	376	U2292GCA	289
U14MA	676	S150860	446	U15686	181	U16CL	683	U2010H	376	U2292GE	288
P14MAP NEW	676	S150861	446	U1583LH	437	U16GA NEW	671	U2011	375	U2292GI	291
U14PO	681	S150862	446	U1586HD	436	U16GPF NEW	690	U2012	374	U2292GV	332
P14POP NEW	681	S150863	446	U1586LH	437	U16MA	675	U2013	375	U2292GX	288
U15000P1	182	S150864	446	U1589HD	436	U16PO	681	U204G	290	U2292MP	289
U15000R1	182	U15097	180	U1589LH	437	P16POP NEW	681	U204GR	290	U22MA	675
U15007	179	U15101	176	U1595LSW	437	S16S	320	U205G	290	U22PO	680
U15007B	179	S151035	448	U1598LSW	437	S17	562	U205GR	290	U23014	277
U15022	178	S151036	448	U1599LSW	437	U1700A	210	U206G	290	U23016	277
U15023	178	S151037	448	U15CA	658	U1700AM	211	U206GR	290	U23018	277
U15024	178	S151038	448	U15CB	678	U1700CM	211	U207G	290	U2302	400
U15026	178	S151100	459	U15CE	677	U170M	293	U207GE	288	U23020	277
U15027	178	S151101	459	U15CL	683	U171012	211	U207GHL	290	U23022	277
U15029	178	S151102	459	U15CN	669	U171113	211	U207GHLV	332	U23024	277
U15030	178	S151120 NEW	459	U15CP	688	U171415	211	U207GI	291	U23026	277
U15032	178	S151121 NEW	459	U15GA NEW	671	U171619	211	U207GWS	290	U2303	400
U15033	178	S151130	459	U15GPF NEW	690	U171718	211	U207GX	288	U23030	277
U15034	178	S151131	459	U15MA	676	U1725	210	U207MP	289	U23032	277
U15035	178	S151133	459	P15MAP NEW	676	U1730	210	U207PE	288	U23034	277
U15036	178	S151134	459	U15PO	681	U1731	210	U208G	299	U23036	277
U15038	178	S151135	460	P15POP NEW	681	S17A NEW	562	U208GM	289	U23038	277
U15039	178	S151136	460	U16000X	270	S17AT NEW	562	U209GCA	289	U2305	400
U15040	178	S151138	460	U16004	271	U17CA	665	U20CA	656	U23050	277
U15041	178	S151140	460	U16004X	270	U17CE	677	U20CL	683	U23054	277
U15042	178	S151144	459	U16008X	270	U17CL	683	U20MA	675	U2307	388
U15044	178	S151150	459	U16012	271	U17GA NEW	672	U20PO	680	U2308	384
U15046	178	S151151	459	U16012X	270	U17GPF NEW	690	U210	352	U2312	396
U15047	178	S151152	459	U16016	271	U17MA	675	U21003	308	U2316	389
U15048	178	S151153	459	U16016X	270	S17N	562	U2108	313	U2317	389
U15050	178	S151154	459	U16020	271	U17PO	681	U2108A	313	U2318	389
U15054	178	S151156	459	U16020X	270	P17POP NEW	681	U211	352	U2319	389
U15056	178	S151200	467	U16025	271	U180	332	U21108	276	U2320	396
U15058	178	S151201	467	U16028X	270	U181	332	U21112	276	U2321	388
U15060	178	S151202	467	U16032	271	U182	332	U2116	308	U2322	388
U15062	178	S151203	467	U16032X	270	U183	332	U2116HD	308	U2323	396
U15064	178	S151210	371	U16036X	270	U18566	297	U211G	287	U2323A	396
U15066	178	S151211	371	U16040	271	U187	332	U212	352	U2324	396

ITEM	PAGE	ITEM	PAGE	ITEM	PAGE	ITEM	PAGE	ITEM	PAGE	ITEM	PAGE
u2325	373	u2363	418	u2404N	404	u2572HL	218	u2627SW	221	u26HL1B	216
u2326	376	u23631	424	u2406N	404	u2576HL	218	u2628MHL	217	u26HL2B	216
u2327	396	u23632	424	u2408N	404	u2580HL	218	u2628SW	221	u26HL3B	216
u2328	390	u2363E	416	u240G	295	u2582HL	218	u2629	222	26MA <small>NEW</small>	676
u2329	388	u2363F	416	u240I	403	u2584	93	u2629HL	217	u270	295
u2330S	382	u2363R	416	u2412	403	u2585	93	u2629SW	221	u2700LP	303
u2331	402	u2363RQ	416	u2412N	405	u2585	93	u262G	295	u270GI	295
u2332	401	u2363S	417	u241G	291	u2588HL	218	u2630	222	u270V	333
u2334	391	u2363V	417	u2420N	405	u258G	290	u2630HL	217	u27100SWM	219
u2335	389	u2363VQ	417	u2450	403	u258MP	289	u2630SW	221	u27105SWM	219
u2336	389	u2363VT	417	u2455MHL	218	u2590	93	u2631SW	221	u27110SWM	219
u2337	375	u2363W	417	u2460	402	u2590B <small>NEW</small>	93	u2632	222	u27115SWM	219
u2338	391	u2364	490	u2460MHL	218	u2591B <small>NEW</small>	93	u2632HL	217	u27120SWM	219
u2340	393	u23640	424	u2465MHL	218	u2592	93	u2632MHL	217	u27125SWH	220
u2340D	392	u23641	419	u2468HL	218	u2592B <small>NEW</small>	93	u2632SW	221	u2714SWH	220
u2340DA	392	u2364I	421	u246G	295	u2593B <small>NEW</small>	93	u2632SWM	221	u2716SW	219
u2340DC	392	u2365	421	u2470HL	218	u2594HL	218	u2633SWM	221	u2716SWH	220
u2340DE	392	u2366	421	u2470MHL	218	u2596HL	218	u2634MHL	217	u2717SW	219
u2340DF	392	u2367	420	u2472	411	u2599HL	218	u2634SW	221	u2717SWH	220
u2340DG	392	u2367M	420	u2472HL	218	u259GHL	290	u2634SWM	221	u2718SW	219
u2340DH	392	u2368	420	u2476HL	218	u259GHLX	288	u2635SW	221	u2718SWH	220
u2340DM	392	u2369	420	u2480HL	218	u25K	379	u2636MHL	217	u2719SW	219
u2340DN	392	u2370	391	u2481	372	25MA <small>NEW</small>	676	u2636SWM	221	u2720SW	219
u2340DP	392	u2370A	391	u2482HL	218	u26001	455	u2636SWM	221	u2720SWH	220
u2341	391	u2371	419	u2484	460	u26021	454	u2637SW	221	u2721SW	219
u2342	389	u2372	356	u2488HL	218	u26023	454	u2638SW	221	u2722SW	219
u2343	388	u2373	400	u2490A	408	u26030	455	u2639SW	221	u2722SWH	220
u2344	383	u2374	401	u2492 <small>NEW</small>	409	u26031	454	u263G	295	u2723SW	219
u2345	395	u2375	401	u2493 <small>NEW</small>	410	u260R	303	u2640SW	221	u2723SWH	220
u2346	401	u2376	401	u2494 <small>NEW</small>	410	u2613	222	u2641MHL	217	u2724SW	219
u2347	389	u2377	401	u2494HL	218	u2614	222	u2641SW	221	u2724SWH	220
u2348	396	u2378	401	u2496HL	218	u2615	222	u2641SWM	221	u2726SW	219
u235	387	u2379	375	u2499HL	218	u2616	222	u2642SW	221	u2726SWH	220
u2350	431	u2380	384	u24HL1B	216	u2616HL	217	u2643SW	221	u2727SW	219
u23501	430	u2381	373	24MA	684	u2616SW	221	u2644SW	221	u2727SWM	219
u23502	430	u2382	392	24PO	680	u2617	222	u2646MHL	217	u2728SW	219
u23503	430	u2385	392	24S	320	u2617HL	217	u2646SW	221	u2728SWH	220
u2351	431	u2386	392	u25000P1	182	u2617SW	221	u2646SWM	221	u2729SWH	220
u2352	431	u2388	384	u25032	179	u2618	222	u264G	295	u2730SW	219
u2355	396 y 431	u2390	384	u25034	179	u2618HL	217	u2650MHL	217	u2730SWH	220
u2356	390	u2390A	384	u25036	179	u2618SW	221	u2650SW	221	u2731SW	219
u2357	390	u2390B	384	u25038	179	u2619SW	221	u2650SWM	221	u2732SW	219
u2358	384	u2391	385	u25038	179	u2619SW	221	u2655SWM	221	u2732SWH	220
u2359	384	u2391A	385	u25044	179	u261R	303	u265G	295	u2732SWM	219
u23600	421	u2392	374	u25048	179	u2620	222	u2660SWM	221	u2734HL	217
u23601	421	u2392A	374	u25050	179	u2620HL	217	u266G	295	u2734SW	219
u23602	421	u2393	380	u25052	179	u2620SW	221	u266R	303	u2735HL	217
u23603	421	u2393	380	u25058	179	u2621	222	u2670SWM	221	u2735SW	219
u23604	424	u2394	391	u25060	179	u2621HL	217	u2675SWM	221	u2735SWH	220
u2361	418	u2395	392	u25062	179	u2621SW	221	u267G	290	u2736HL	217
u23610	421	u2397	382	u25064	179	u2622SW	221	u267GCA	289	u2736SW	219
u23615	423	u2397	382	u25066	179	u2623	222	u267GE	288	u2736SWH	220
u23616	423	u2397I	382	u25070	179	u2623HL	217	u2680SWM	221	u2736SWM	219
u23617	423	u23972	382	u25072	179	u2623SW	221	u268G	290	u2737SW	219
u2362	418	u23973	381	u25074	179	u2624	222	u268GHL	290	u2738SW	219
u23620	423	u23975	382	u25076	179	u2624HL	217	u268GI	291	u2738SWH	220
u23621	423	u2398	391	u25078	179	u2624MHL	217	u268GX	288	u2738SWH	220
u23622	422	u239G	291	u25080	179	u2624SW	221	u269G	290	u2739HL	290
u23623	422	23MA	675	u25080	179	u2625MHL	217	u269GHL	290	u274	295
u23624	418	23PO	680	u250G	287	u2625SW	221	u269GHLV	332	u2740HL	217
u23625	419	u23RG350	399	u251G	287	u2626	222	u269GI	291	u2740SW	219
u23626	418	u23RO350	399	u2555MHL	218	u2626HL	217	u269GX	288	u2740SWH	220
u23627	419	u23RO450	399	u255G	375	u2626MHL	217				
u23628	422	u23RW350	399	u2560MHL	218	u2626SW	221				
u23629	422	u23RW450	399	u2565MHL	218	u2627	222				
		u24016	277	u2568HL	218	u2627HL	217				
		u24020	277	u2570HL	218	u2627MHL	217				
		u2402N	404	u2570MHL	218						

ITEM	PAGE	ITEM	PAGE	ITEM	PAGE	ITEM	PAGE	ITEM	PAGE	ITEM	PAGE	ITEM	PAGE
u2741HL	217	u280G	296	u3000N	206	u32BL	652	u367P	286	u404	364	u404	362
u2741SW	219	u28140	293	u3016	206	u32S	320	u368G	286	u4044	362	u4045	362
u2741SWH	220	u28140X	293	u3018	206	u330	346	u368P	286	u4046	362	u4047	362
u2741SWM	219	u28141	293	u302	299	u3305	467	u369G	286	u4047	362	u404PRO	364
u2742HL	217	u28141P	294	u3020	206	u330R	346	u369P	286	u4047	362	u404W	364
u2742SW	219	u28141X	293	u3021	206	u3310	467	P36POP NEW	682	u4050	364	u4051	357
u2744HL	217	u28142X	293	u3025	206	u332	346	u370	285	u4052	357	u4053	356
u2744SW	219	u2817SWH	220	u3026	206	u3320	467	u3700M	214	u406	364	u406PRO	364
u2744SWH	220	u2820SWH	220	u303	299	u33236	207	u3709M	214	u406W	364	u4071	301
u2746HL	217	u2823SWH	220	u3030	206	u332R	346	u370L	284	u4072	301	u4072U	301
u2746SW	219	u2826SWH	220	u30301	306	u3330	467	u371	285	u4073	301	u408	364
u2746SWM	219	u2829SWH	220	u3031	206	u3350	467	u3710M	214	u408PRO	364	u408W	364
u2747HL	217	u282G	290	u3033	206	u33641	207	u3713M	214	u4091	301	u4099	301
u2747SW	219	u282GR	290	u3034	206	u33BL	652	u3715M	214	u40P	387	P40POP NEW	682
u2747SWH	220	u2832SWH	220	u3035	206	u34 1/4	243	u3716M	214	u40S	320	u410	364
u2748HL	217	u2835SWH	220	u3038	206	u34 3/8	243	u372	285	u4100	301	u4100A	301
u2748SW	219	u2838SWH	220	u3039	206	u34014	564	u373	285	u4100B	301	u4100C	301
u274GI	295	u2840	309	u303B	306	u34016	564	u374	285	u4101	301	u4102	301
u275	295	u2840HD	308	u303L	306	u34018	564	u374L	284	u4102U	301	u4102UR	301
u2750HL	217	u2841SWH	220	u303LS	306	u34020	564	u375	285	u4103	301	u4104U	301
u2750SW	219	u2844SWH	220	u303R	306	u34022	564	u376	285	u410PRO	364	u410W	364
u2750SWH	220	u2850	309	u303RS	306	u347	345	u3760	214	u41-1/2	315	u41-1/4	315
u2750SWM	219	u2850HD	308	u303S	306	u348	345	u3764	214	u4111	301	u4116	301
u2754SW	219	u28520	293	u303U	305	u349	343	u3768	214	u4118	301	u412	364
u2755MHL	217	u28520P	294	u304	300	u349F	343	u377	285	u4120	301	u4122	301
u2755SWM	219	u28520X	293	u3040	206	u34BL	652	u3772	214	u4122	301	u4124	301
u2756HL	217	u28560	293	u3045	206	P34POP NEW	682	u378	285	u4128	301	u4129	301
u2756SW	219	u28580	293	u3050	206	u35 1/4	243	u379	285	u4129	301	u412PRO	364
u2756SWH	220	u28580X	293	u3051	206	u350	344	P37POP NEW	682	u412W	364	u4137	301
u276	296	u2860	309	u3055	206	u350D19C	345	u381	283	u4137	301	u41-5/16	315
u2760HL	217	u2860HD	308	u3060	206	u350D19G	345	u3812	214	u4138	301	u41-5/8	315
u2760MHL	217	u28641	293	u30607	207	u350D19S	345	u3818	214	u416F	321	u416PR	321
u2760SW	219	u28660X	293	u307	300	u350F	345	u382	283	u417/16	315	u4182	345
u2760SWM	219	u286LN	303	u3070	206	u350P	344	u3820	214	u41A	315	u4186	345
u2762HL	217	u287G	305	u3075	206	u350QR	344	u3824	214	u41CFU NEW	655	P41POP NEW	682
u2762SW	219	u288G	305	u3080	206	u351	343	u3828	214	u4205	356		
u2765MHL	217	u289G	305	u30809	207	u351F	343	u383	283				
u2765SWM	219	u289GV	333	u30810	207	u352	562	u383	285				
u2766SW	219	u289LN	303	u309	300	u352M NEW	563	u385L	284				
u2768SW	219	u291	298	u30910	207	u353AT	562	u389	287				
u276G	296	u291P	298	S30P	387	u353F	562	P38POP NEW	682				
u2770MHL	217	u291R	303	u310	300	u354P	562	u391	287				
u2770SWM	219	u292	298	u31011	207	u355	344	u3914	287				
u2772SW	219	u292WR	303	u31012	207	u355D26M	344	u397	287				
u2774SW	219	u292WRG	302	u312	300	u355D31M	344	u398	287				
u2775MHL	217	u293	298	u31213	207	u356	344	u3989	287				
u2775SWM	219	u293R	303	u313	299	u359	344	u399	285				
u2776SW	219	u293RG	302	u31415	207	u359D41M	344	u399L	284				
u278	296	u293WR	303	u31417	207	u35CFU NEW	655	P39POP NEW	682				
u2780MHL	217	u294WR	303	u31617	207	P35POP NEW	682	u3RB	393				
u2780SW	219	u296	298	u31819	207	u36 1/4	243	u4011	362				
u2780SWM	219	u297	298	u31922	207	u36 3/8	243	u4011S	362				
u2785MHL	217	u298	298	u31CFU NEW	655	u36 5/16	243	u4012S	362				
u2785SWM	219	u299	298	u32021	207	u360A	285	u4015	362				
u2786SW	219	u2RB	393	u320G	306	u360B	285	u4016	362				
u278B	296	u30000A	207	u32122	207	u360C	284	u4017	362				
u278G	296	u30000R	207	u322G	306	u360D	284	u4018	362				
u2790SWM	219	u30000RM	207	u32427	207	u361RKA	284	u4019	67				
u2792SW	219	u30004	276	u324G	306	u361RKB	284	u402	364				
u2795SWM	219	u3000C	206	u32528	207	u364	284	u403	364				
u2796SW	219	u3000D	206	u327	346	u364RKB	284	u4030	361				
u27HL1B	216	u3000G	206	u32732	207	u365	284	u4030B	361				
u27HL2B	216	u3000H	206	u327R	346	u366G	286	u4030BB	361				
u280	296	u3000I	206	u329	346	u366P	286	u4033	362				
u280B	296	u3000IM	207	u329R	346	u367G	286	u4034	362				

# 28 NUMERICAL INDEX

ITEM	PAGE	ITEM	PAGE	ITEM	PAGE	ITEM	PAGE	ITEM	PAGE	ITEM	PAGE
U 4205A	356	U 42L4	316	U 45306	363	U 46508G	251	U 4700PM	99	U 4714M	113
S 420PR	321	U 42L5	316	P 45POP NEW	681	U 46508GP	250	U 47015	466	U 4714T	112
U 4211	360	U 42L6	316	U 46300	464	U 46508LBGP	248	U 4701CD	99	U 4715LM	115
U 4211S	361	U 42L8	316	U 46301	464	U 46508LGP	249	U 4701GT	96	U 4715M	113
U 4212	360	U 42N10	316	U 46302	464	U 46510	252	U 4702	358	U 4716	112
U 4212SJ	360	U 42N4	316	U 46303	464	U 46510G	251	U 47045M	113	U 4716L	114
U 4212SJB	360	U 42N5	316	U 464	343	U 46510GP	250	U 4704LM	115	U 4716T	112
U 4212SJBB	360	U 42N6	316	U 46405GP	250	U 46510LBGP	248	U 4704M	113	U 4718	112
U 4213	360	U 42N8	316	U 46405LBGP	248	U 46510LGP	249	U 4705	112	U 4718L	114
U 4213B	360	P 42POP NEW	682	U 46405LGP	249	U 46512	252	U 47055LM	115	U 4718T	112
U 4214	360	U 4331	357	U 46406	252	U 46512G	251	U 47055M	113	U 47201	101
U 4214B	360	U 4332	357	U 46406G	251	U 46512GP	250	U 4705LM	115	U 47202	115
U 4215	360	U 4333	357	U 46406GP	250	U 46512LBGP	248	U 4705M	113	U 47204	112
U 4215B	360	U 4334	357	U 46406LBGP	248	U 46512LGP	249	U 4705T	112	U 47205	101
U 4215Q	361	U 43601	363	U 46406LGP	249	U 46514	252	U 4706	112	U 47206	101
U 4216	359	U 43602	363	U 46407	252	U 46514G	251	U 4706L	114	U 47207	113
U 4216Q	361	U 43610	363	U 46407G	251	U 46514GP	250	U 4706LM	115	U 4725	67
U 4217Q	361	U 43615	363	U 46407GP	250	U 46514LBGP	248	U 4706M	113	U 47-3/8X3/16	314
U 4218Q	361	U 43620	363	U 46407LBGP	248	U 46514LGP	249	U 4706T	112	U 47315	466
U 42300	465	P 43POP NEW	681	U 46407LGP	249	U 46516	252	U 4707	112	U 473908W	116
U 42301	465	S 4404M	113	U 46408	252	U 46516G	251	U 4707L	114	U 473910W	116
U 42303	465	S 4405	112	U 46408G	251	U 46516GP	250	U 4707LM	115	U 473915W	116
U 42305	465	S 4405M	113	U 46408GP	250	U 46516LBGP	248	U 4707M	113	U 473920W	116
U 42307	465	S 4406	112	U 46408LBGP	248	U 46516LGP	249	U 4707T	112	U 473925W	116
U 42310	465	S 4406M	113	U 46408LGP	249	U 46518	252	U 4708	112	U 473927W	116
U 4232SJ	362	S 4407	112	U 46409	252	U 46518G	251	U 4708L	114	U 473930W	116
U 4232SJB	362	S 4407M	113	U 46409G	251	U 46518GP	250	U 4708LM	115	U 4739C	116
U 4234	361	S 4408	112	U 46409GP	250	U 46518LBGP	248	U 4708M	113	U 4749	148
U 4234B	361	S 4408M	113	U 46409LBGP	248	U 46518LGP	249	U 4708T	112	U 4749G	150
U 4234BB	361	S 4409	112	U 46409LGP	249	U 46519GP	250	U 4709	112	U 4749GRK	153
U 4238	361	S 4409M	113	U 46410	252	U 46519LBGP	248	U 4709L	114	U 4749H	147
U 4238B	361	U 44-1/2	315	U 46410G	251	U 46519LGP	249	U 4709LM	115	U 4749J NEW	148
S 424CF	321	U 44-1/4	315	U 46410GP	250	U 46520	252	U 4709M	113	U 4749IX NEW	147
U 424HD	367	S 4410	112	U 46410LBGP	248	U 46520G	251	U 4709T	112	U 4749RKA	153
U 424HDK	367	S 4410M	113	U 46410LGP	249	U 46520GP	250	U 47-1/2X1/4	314	U 4749T	278
U 424N	368	S 4411	112	U 46412	252	U 46520LBGP	248	U 47-1/4X1/16	314	U 47-5/16X1/8	314
U 424NK	368	S 4411M	113	U 46412G	251	U 46520LGP	249	U 47-1/4X3/32	314	U 47-5/16X5/32	314
U 424XP	367	S 4412	112	U 46412GP	250	U 46521GP	250	U 4710	112	U 475254	96
S 425CF	321	S 4412M	113	U 46412LBGP	248	U 46521LBGP	248	U 47101	101	U 475254T	98
U 425HD	367	S 4413M	113	U 46412LG	251	U 46521LGP	249	U 47102	114	U 475254W	98
U 425HDK	367	S 4414	112	U 46412LGP	249	U 46522	252	U 47106	112	U 4752A	150
U 425MP	368	S 4416	112	U 46414	252	U 46522G	251	U 4710L	114	U 4752E	98
U 425N	368	U 44180	73	U 46414G	251	U 46522GP	250	U 4710LM	115	U 4752GT	96
U 425NK	368	U 44185	73	U 46414GP	250	U 46522LBGP	248	U 4710M	113	U 4752W	98
U 425XP	367	U 44-3/8	315	U 46414LBGP	248	U 46522LGP	249	U 4710T	112	U 4754P	97
U 42600	465	U 44-5/16	315	U 46414LGP	249	U 467110GP	250	U 4711	112	U 4754P50	97
U 42601	465	U 44-5/8	315	U 46416	252	U 467115GP	250	U 47110	100	U 4754P50M	98
U 42602	465	U 44-7/16	315	U 46416G	251	U 467120GP	250	U 47111	100	U 4754PM	98
U 42603	465	U 44A	315	U 46416GP	250	U 467125GP	250	U 47112	100	U 4760	144
U 42605	465	P 44POP NEW	681	U 46416LBGP	248	U 467127GP	250	U 47115	466	U 4761	144
U 426HD	367	U 450	352	U 46416LG	251	U 467130GP	250	U 47116	100	U 4762	144
U 426HDK	367	U 451	352	U 46416LGP	249	U 467140GP	250	U 4711L	114	U 4763	144
U 426N	368	U 45103	363	U 46420	252	U 467145GP	250	U 4711LM	115	U 4764	144
U 426NK	368	U 45106	363	U 46420G	251	U 467150GP	250	U 4711M	113	U 4765	145
U 426XP	367	U 452	352	U 46420GP	250	U 46716GP	250	U 4711T	112	U 4766	145
U 4270A	358	U 45202	363	U 46420LBGP	248	U 46717GP	250	U 4712	112	U 4766RS	146
U 4276	356	U 45203	363	U 46420LG	251	U 46718GP	250	U 4712L	114	U 4769	144
U 427HD	367	U 45204	363	U 46420LGP	249	U 46719GP	250	U 4712LM	115	U 47-7/16X7/32	314
U 427HDK	367	U 45205	363	U 46424	252	U 4700A	99	U 4712M	113	U 4770	154
U 4285	358	U 45206	363	U 46424G	251	U 4700C	101	U 4712T	112	U 4770-1/16	117
U 428N	368	U 45300 NEW	463	U 46424GP	250	U 4700CA	100	U 4713LM	115	U 4770-1/4	117
U 428NK	368	U 45301 NEW	463	U 46424LBGP	248	U 4700CB	100	U 4713M	113	U 4770-1/8	117
U 428XP	367	U 45302 NEW	463	U 46424LG	251	U 4700CM	99	U 4714	112	U 4770-10	117
U 42HDK	367	U 45303 NEW	463	U 46424LGP	249	U 4700D	97	U 4714L	114	U 477025M	117
U 42L10	316	U 45305	363	U 46508	252	U 4700P	99	U 4714LM	115	U 47702M	117

ITEM	PAGE	ITEM	PAGE	ITEM	PAGE	ITEM	PAGE	ITEM	PAGE	ITEM	PAGE
U4770-3/16	117	U4913M	127	U49-5/8	258	U49-8L	257	U49T10	258	U5020	120
U4770-3/32	117	U4914	127	U49-5/8BP	257	U49-9	258	U49T15	258	U502050	387
U47703M	117	U49-14	258	U49-5/8L	257	U49-9/16	258	U49T20	258	U5020H	120
U47704M	117	U49-14BP	257	U49-5BP	257	U49-9/16L	257	U49T25	258	U5020HM	121
U4770-5/32	117	U4914M	127	U49-5L	257	U49-9/64	258	U49T27	258	U5021HM	121
U4770-5/64	117	U4915M	127	U49-5V	331	U49-9/64BP	257	U49T30	258	U5022	120
U47705M	117	U4916	127	U49-6	258	U49-9/64L	257	U49T40	258	U5022H	120
U4770-6	117	U4916M	127	U4965	252	U49900	324	U49T45	258	U5022HM	121
U47706M	117	U49-17	258	U4965G	251	U49900M	324	U49T55	258	U5023HM	121
U4770-7/32	117	U4917M	127	U4965GPM	250	U49901	324	U49T7	258	U5024	120
U4770-7/64	117	U4918	127	U4965LBGPM	248	U4990-1/4	124	U49T8	258	U5024H	120
U4770-9/64	117	U4918M	127	U4965LGPM	249	U4990-1/4L	125	U49T9	258	U5026	120
U4771	143	U49-19	258	U4966	252	U4990-1/8	124	U4F12X	365	U5026H	120
U4771X	116	U4919M	127	U49668TGP	250	U4990-1/8L	125	U4F18X	365	U5026HPA	387
U4772	116	U49-1L	257	U4966G	251	U499010M	125	U4F24X	365	U5028	120
U4774	116	U49-2	258	U4967GP	250	U49901OML	126	U4FM12	365	U5028H	120
U4775	116	U49-2.5	258	U4967LBGP	248	U49902	324	U4FM24	365	U50-3/16	315
U4785	143	U49-2.5BP	257	U4967LGP	249	U49902A	324	S5	381	U50-3/8	315
U47A	314	U4920	127	U49-6BP	257	U49903	313	U50004	280	U5030	120
U47B NEW	311	U49-2-0	258	U49-6L	257	U4990-3/16	124	U50004X	280	U5030A	383
U47G-1/2X1/4	314	U4921M	127	U49-6V	331	U4990-3/16L	125	U50006	280	U5030H	120
U47G-7/16X7/32	314	U4922	127	U49-7	258	U4990-3/8	124	U50012	280	U5030S	383
U48-1/2 X 1/4	314	U49-22	258	U49-7/16	258	U4990-3/8L	125	U50020	280	U5032	120
U48-1/2 X 5/16	314	U4922M	127	U49-7/16BP	257	U49904	313	U5003B	102	U5032H	120
U48-3/8 X 3/16	314	U4924	127	U49-7/16L	257	U49904M	125	U5006HM	121	U50-5/16	315
U48-3/8 X 5/32	314	U49-24	258	U49-7/32	258	U49904ML	126	U5007HM	121	S506	185
U48-7/16 X 7/32	314	U4926	127	U49-7/32BP	257	U4990-5/16	124	U5008	120	S50607 NEW	207
U48A	314	U49-27	258	U49-7/32L	257	U4990-5/16L	125	U5008H	120	S506CA NEW	184
U48B NEW	310	U4928	127	U49-7/64	258	U4990-5/32	124	U5008HM	121	S506P	184
S48S	320	U49-28BP	257	U49-7/64BP	257	U4990-5/32L	125	U5008M	121	S506S	186
U4900-10	127	U49-3	258	U49-7/64L	257	U49905M	125	U5009HM	121	U50-7/16	315
U4900-12M	127	U49-3/16	258	U49-7/8	258	U49905ML	126	U5009M	121	S508	185
U4900BD	126	U49-3/16BP	257	U49-7/8L	257	U49906M	125	U50-1/2	315	S50809 NEW	207
U4901V NEW	331	U49-3/16L	257	U4972	255	U49906ML	126	U50-1/4	315	S508P	184
U4901VM NEW	331	U49-3/16V	331	U4972M	254	U49907	124	U5010	120	S508S	186
U49-1	258	U49-3/32	258	U4972MHD	254	U4990-7/32	124	U50104X	280	U50900	324
U49-1.27	258	U49-3/32BP	257	U4972R	254	U4990-7/32L	125	U5010H	120	U509-1	324
U49-1.5	258	U49-3/32L	257	U4972RHD	254	U4990-7L	125	U5010HM	121	U509-1/2	324
U49-1.5BP	257	U49-3/4	258	U4972T	256	U49907M	125	U5010M	121	U509-1-1/2	324
U49-1/16	258	U49-3/4BP	257	U4972TB	256	U49907ML	126	U5011HM	121	U509-1-1/4	324
U49-1/16BP	257	U49-3/4L	257	U4972TL	256	U49908M	125	U5011M	121	U509-2	324
U49-1/2	258	U49-3/8	258	U4972TT	256	U49908ML	126	U5012	120	U509-2-1/2	324
U49-1/2BP	257	U49-3/8BP	257	U4973	259	U49908DM	126	U5012H	120	U509-3	324
U49-1/2L	257	U49-3/8L	257	U4973BM	261	U4990M6	125	U5012HM	121	U509-3/4	324
U49-1/4	258	U4932	127	U4974	259	U4990SML	126	U5012M	121	U509-3-1/2	324
U49-1/4BP	257	U49-32	258	U4975	255	U4991-10M	126	U5013HM	121	U509-4	324
U49-1/4L	257	U49-36	258	U4975M	255	U49915	313	U5013M	121	U509-7/8	324
U49-1/4V	331	U49-3BP	257	U4976A	255	U4991-5M	126	U5014	120	U50A	315
U49-1/8	258	U49-3L	257	U4976TX	261	U49916	313	U5014H	120	S510	185
U49-1/8BP	257	U49-3V	331	U4977	255	U4991-6M	126	U5014HM	121	S51011 NEW	207
U49-1/8L	257	U49-4	258	U4977B	260	U4991-7M	126	U5014M	121	S510P	184
U49-1/8V	331	U49-4BP	257	U4977BM	261	U4991-8M	126	U5015HM	121	S510S	186
U49-10	258	U49-4L	257	U4977M	255	U4991M5	126	U5015M	121	U51115	528
U49-10BP	257	U49-4V	331	U4977TX	261	U4992	259	U5016	120	U5113	528
U49-10L	257	U49-5	258	U4977TXT	261	U49920	313	U5016H	120	U5115	528
U4910M	127	U49-5/16	258	U4978	259	U49922	313	U5016HM	121	S512	185
U49-1-1/2	258	U49-5/16BP	257	U4978B	260	U49923	313	U5016M	121	U5121	528
U49-1-1/4	258	U49-5/16L	257	U4979TX	259	U4993	259	U5017HM	121	S51213 NEW	207
U49-1-1/8	258	U49-5/32	258	U49-7BP	257	U4994	259	U5017M	121	U5129	528
U4911M	127	U49-5/32BP	257	U49-8	258	U4994B	260	U5018	120	S512D NEW	226
U4912	127	U49-5/32L	257	U49816	260	U4995	253	U5018H	120	S512P	184
U49-12	258	U49-5/32V	331	U49822	253	U4995HD	253	U5018HM	121	S512S	186
U49-12BP	257	U49-5/64	258	U49822HD	253	U4996	253	U5018M	121	S51415 NEW	207
U4912M	127	U49-5/64BP	257	U49824	260	U4996HD	253	U5019HM	121	S515	185
U49-1-3/4	258	U49-5/64L	257	U49-8BP	257	U49-9BP	257	U5019M	121	S5152A	151

ITEM	PAGE	ITEM	PAGE	ITEM	PAGE	ITEM	PAGE	ITEM	PAGE	ITEM	PAGE
515S	186	5214M	119	523945W	123	5314HM	133	538D <small>NEW</small>	226	5414TX	134
5160	532	5214TX	123	523950W	123	5314M	133	5396	67	5415HM	130
51617 <small>NEW</small>	207	5215HM	119	5239C	123	5315HM	133	53CA	666	5415M	130
518	185	5215M	119	5239S	123	5315M	133	5400AB	106	5416	128
51819 <small>NEW</small>	207	5216	118	524	185	5316	132	5400CB	105	5416H	128
518S	186	5216H	118	5249	148	5316H	132	5400G	105	5416HM	130
5200A	98	5216HM	119	524947N	151	5316HM	133	5400M	108	5416M	130
5200AC	103	5216M	119	5249B	149	5316M	133	5400MV	327	5416TX	134
5200B	102	5216S	122	5249G	150	5317HM	133	5400MWI <small>NEW</small>	327	5417	128
5200CB	102	5217	118	5249GRK	153	5317M	133	5400P	106	5417HM	130
5200CL	102	5217HM	119	5249H	147	5318	132	5400PA	128	5417M	130
5200LP	103	5217M	119	5249I <small>NEW</small>	148	5318H	132	5400PAM	130	5418	128
5200LPM	104	5218	118	5249IX <small>NEW</small>	147	5318HM	133	5400PB	106	5418H	128
5200M	104	5218H	118	5249RKA	153	5318M	133	5400PBM	108	5418HM	130
5200PA	101	5218HM	119	5249S	150	5319HM	133	5400PC	106	5418M	130
5200TX	123	5218M	119	524S	186	5319M	133	5400PD	104	5418TX	134
5201CD	102	5218TX	123	5252A	150	5320	132	5400PH	132	5419	128
5201GT	96	5219	118	5252ARK	153	532050	387	5400PHM	133	5419H	128
5204TX	123	5219HM	119	5253	143	5320H	132	5400PPM	108	5419HM	130
5205TX	123	5219M	119	5254	143	5320HM	133	5400SPM	104	5419M	130
5206HM	119	5220	118	5254H <small>NEW</small>	99	5320M	133	5400TX	134	5420	128
5206M	119	52203	121	5254HM <small>NEW</small>	99	5321HM	133	5400V	327	54203	133
5206TX	123	52205	121	5254P34	97	5321M	133	5400VI <small>NEW</small>	327	54205	130
5207HM	119	52209	121	5254P36	97	5322	132	5401CD	105	54206	130
5207M	119	5220H	118	5254TH	375	5322H	132	5401GT	96	54207	133
5207TX	123	5220HM	119	5255	143	5322HM	133	5404B	105	54208	108
5208	118	5220M	119	5256	143	5322M	133	5408	128	54208H	109
5208H	118	52211	119	5260	144	5323HM	133	5408H	128	54209	130
5208HM	119	52212	119	526006	144	5323M	133	5408HM	130	5420H	128
5208M	119	52215	119	526006QR	145	5324	132	5409HM	130	5420HM	130
5208TX	123	52216	119	526006W	145	5324H	132	5410	128	5420M	130
5209HM	119	52218	104	5260W	145	5324HM	133	54103	132	5420TX	134
5209M	119	5221HM	119	5261	144	5324M	133	54107	132	54210	108
5210	118	5221M	119	5262	144	5325HM	133	54109	128	54210H	108
52107	120	5222	118	5263	144	5325M	133	5410H	128	54211	130
5210H	118	52220	103	5263QR	145	5326	132	5410HM	130	54212	130
5210HM	119	52222	104	5264	144	5326H	132	5410M	130	54213	130
5210M	119	5222H	118	5265	145	5326HM	133	5410TX	134	54214	130
5210S	122	5222HM	119	5265H	145	5326HPA	387	54110	128	54214A	108
5210TX	123	5222M	119	5265RS	146	5326M	133	54111	128	54215	133
5211	118	5223HM	119	5268	145	5327HM	133	54112	128	54216	133
52111	120	5223M	119	5270	154	5327M	133	54113	128	5421HM	130
52112	120	5224	118	5273H	122	5328	132	54114	128	5421M	130
52114	120	5224H	118	5274MH	122	5328H	132	54115	128	5422	128
52118	118	5224HM	119	5276H	122	5328M	133	54116	106	5422H	128
5211HM	119	5224M	119	5278H	122	5329M	133	54117	132	5422HM	130
5211M	119	5225HM	119	5278MH	122	5330	132	54118	132	5422M	130
5211TX	123	5225M	119	5279MH	122	5330H	132	54119	128	5423HM	130
5212	118	5226	118	5280	144	5330HM	133	54120	106	5423M	130
52122	118	5226H	118	5280MH	122	5330M	133	54121	128	5424	128
52124	118	5226HM	119	5282MH	122	5331M	133	54122	106	5424HM	130
52126	118	5226M	119	5285	143	5332	132	54124	105	5424M	130
52128	103	5228	118	52ET14	122	5332H	132	5412H	128	5425	128
5212H	118	5228H	118	5300A	106	5332HM	133	5412HM	130	5425H	128
5212HM	119	5230	118	5300H	132	5332M	133	5412M	130	5425HM	130
5212M	119	5230H	118	5310HM	133	5334	132	5412TX	134	5425M	130
5212TX	123	5232	118	5310M	133	5334H	132	5413HM	130	5426	128
52130	103	5232H	118	5311HM	133	5334HM	133	5414	128	5426HM	130
52134	103	523910W	123	5311M	133	5336	132	5414H	128	5427HM	130
52136	102	523915W	123	5312H	133	5336H	132	5414HM	130	5427M	130
5213HM	119	523920W	123	5312M	133	5336HM	133	5414M	130		
5213M	119	523925W	123	5313HM	133	5340	132				
5214	118	523927W	123	5313M	133	5340H	132				
5214H	118	523930W	123	5314H	132	5348H	132				
5214HM	119	523940W	123			534D <small>NEW</small>	226				

ITEM	PAGE	ITEM	PAGE	ITEM	PAGE	ITEM	PAGE	ITEM	PAGE	ITEM	PAGE
u 5428	128	u 5441-9/16L	136	u 54P17M	109	u 5538H	138	u 5668B	146	u 6001	226
u 5428H	128	u 5441M5L	137	u 54P20	109	u 5538HL	141	u 5668H	145	u 6002	226
u 5428HM	130	u 5441M6	136	u 54P28	108	u 5538HM	140	u 5668RS	146	u 6002NM	227
u 5428M	130	u 5442	128	u 54P42	105	u 5538M	140	u 5670	154	u 6003	226
u 5428SPL	134	u 5442H	128	u 55004	279	u 5540	138	u 5685	143	u 6005IL	227
u 5429	128	u 5443-10M	137	u 5500C	110	u 5540H	138	u 5686	146	u 6006	226
u 5429HM	130	u 5443-12M	137	u 5500NR	110	u 5540HL	141	u 5686B	181	u 6007	226
u 5429M	130	u 5443-14M	137	u 55010	279	u 5540M	140	u 5696	67	u 6007FL	227
u 5430	128	u 5443-16M	137	u 55012	279	u 5541HM	140	u 56CA	657	u 600B	323
u 5430H	128	u 5443-9M	137	u 55100H	110	u 5541M	140	u 57100	111	u 6010FL	227
u 5430HM	130	u 5443M5	137	u 55102H	110	u 5542	138	u 57102	111	u 6010NM	227
u 5430M	130	u 5444	128	u 55104	110	u 5542H	138	u 57104	111	u 6012	228
u 5431	128	u 5444H	128	u 55109	138	u 5542HL	141	u 5734	142	u 6012A	226
u 5431M	130	u 5446	128	u 55111	141	u 5542M	140	u 5736	142	u 6013	228
u 5432	128	u 5446H	128	u 55113	138	u 5544	138	u 5740	142	u 60142	265
u 5432H	128	u 5447PA	96	u 5519HM	140	u 5544HL	141	u 5741M	142	u 60143	226
u 5432HM	130	u 5448	128	u 5519M	140	u 5544M	140	u 5742	142	u 6015FL	227
u 5432M	130	u 5448H	128	u 55200	111	u 5546	138	u 5744	142	u 6015IL	227
u 5434	128	u 5449	148	u 55200H	111	u 5546H	138	u 5746	142	u 6016	226
u 5434H	128	u 5449 14BL	153	u 55202	110	u 5546HL	141	u 5746M	142	u 601KFL	227
u 5434HM	130	u 544952N	151	u 55205	140	u 5546HM	140	u 5748	142	u 601KIL	227
u 5434M	130	u 544952NRK	153	u 55207	140	u 5546M	140	u 5750M	142	u 6020	226
u 5436	128	u 5449B	149	u 5520M	140	u 5548	138	u 5752	142	u 6021	226
u 5436H	128	u 5449G	150	u 5521M	140	u 5548H	138	u 5755M	142	u 6022	227
u 5436HM	130	u 5449GRK	153	u 5522HM	140	u 5548HL	141	u 5756	142	u 60242	273
u 5436M	130	u 5449H	147	u 5522M	140	u 5550	138	u 5758	142	u 60244	273
u 5438	128	u 5449J <small>NEW</small>	148	u 5523M	140	u 5550H	138	u 5760	142	u 6025FL	227
u 5438H	128	u 5449IX <small>NEW</small>	147	u 5524	138	u 5550HL	141	u 5760M	142	u 6025IL	227
u 543920W	134	u 5449RKA	153	u 5524HM	140	u 5550HM	140	u 5764	142	u 6035NM	227
u 543925W	134	u 5449S	150	u 5524M	140	u 5550M	140	u 5765M	142	u 603KIL	227
u 543930W	134	u 5449SC	153	u 5525HM	140	u 5552	138	u 5768	142	u 6045FL	227
u 543940W	134	u 5450	149	u 5525M	140	u 5552H	138	u 5770	142	u 6060FL	227
u 543945W	134	u 5452	97	u 5526	138	u 5552HL	141	u 5770M	142	u 6061A	227
u 543950W	134	u 5452A	150	u 5526M	140	u 5554	138	u 5772	142	u 6062A	227
u 543955W	134	u 5452ARK	153	u 5527HM	140	u 5554H	138	u 5775M	142	u 6064A	227
u 5439C	134	u 5452FL	152	u 5527M	140	u 5554M	140	u 5776	142	u 6066A	227
u 5440	128	u 5452PT	97	u 5528	138	u 5555M	140	u 5780	142	u 60760	278
u 5440H	128	u 5453	143	u 5528HL	141	u 5556	138	u 5782	142	u 60770	278
u 5441-1/2	135	u 5457	151	u 5528HM	140	u 5558	138	u 5784	142	u 60780	278
u 5441-1/2L	136	u 5460	144	u 5528M	140	u 5558H	138	u 5788	142	u 60790	278
u 5441-1/4	135	u 5461	144	u 5529M	140	u 5558M	140	u 5794	142	u 608	323
u 544110M	136	u 5461QR	145	u 5530	138	u 5560	138	u 5796	142	u 60800	278
u 544110ML	137	u 5463	144	u 5530H	138	u 5560H	138	u 57CA	657	u 6080NM	227
u 544112M	136	u 5463QR	145	u 5530HL	141	u 5560M	140	u 5800	142	u 60810	278
u 544112ML	137	u 546420	144	u 5530HM	140	u 5564	138	u 5800A	111	u 60820	278
u 544114M	136	u 546424	144	u 5530M	140	u 5564H	138	u 5812	142	u 608B	323
u 544114ML	137	u 546430	144	u 5531M	140	u 5566	138	u 5849	148	u 6105A	228
u 544117M	136	u 546436	144	u 5532	138	u 5568	138	u 5849RK	153	u 6105B	228
u 544117ML	137	u 5466	145	u 5532HL	141	u 5570	138	u 5850	149	u 6106A	228
u 544119M	136	u 5466H	145	u 5532HM	140	u 5572	138	u 5853	143	u 6106B	228
u 5441-3/4	135	u 5466RS	146	u 5532M	140	u 5574	138	u 5854	143	u 6107A	228
u 5441-3/8	135	u 5467	145	u 5533HM	140	u 5576	138	u 5861	144	u 6107B	228
u 5441-3/8L	136	u 5467H	145	u 5533M	140	u 55CA	657	u 5863	144	u 6108B	228
u 5441-5/16	135	u 5468	145	u 5534	138	u 56020X	279	u 5868	145	u 6109B	228
u 5441-5/16L	136	u 5468B	146	u 5534H	138	u 56120X	279	u 5868B	146	u 6119	226
u 5441-5/8	135	u 5468H	145	u 5534HL	141	u 5649	148	u 5868H	145	u 6124	226
u 5441-5/8L	136	u 5470	154	u 5534HM	140	u 564958N	151	u 5868RS	146	u 6126	226
u 54416L	136	u 5480	144	u 5534M	140	u 5649H	147	u 5870	154	u 61560	226
u 54416M	136	u 5484	143	u 5535M	140	u 5649QRK	153	u 5885	143	u 616	323
u 54417	135	u 5485	143	u 5536	138	u 5649RK	153	u 5886	146	u 616B	323
u 5441-7/16	135	u 5486	146	u 5536H	138	u 5653	143	u 5886B	181	u 61730	226
u 5441-7/16L	136	u 5493	67	u 5536HL	141	u 5660	144	u 5896	67	u 61919	262
u 54418M	136	u 5495	67	u 5536HM	140	u 5661	144	u 58CA <small>NEW</small>	670	u 61919X	262
u 54418ML	137	u 5496	67	u 5536M	140	u 5663	144	u 600	323	u 61927	266
u 5441-9/16	135	u 54CA	666	u 5538	138	u 5668	145	u 6000	226	u 61932	266

ITEM	PAGE	ITEM	PAGE	ITEM	PAGE	ITEM	PAGE	ITEM	PAGE	ITEM	PAGE
U 61956	265	U 6908M	157	U 708XS	184	U 72-3/8	313	U 7318MT	166	U 7401C <small>NEW</small>	163
U 6202A	225	U 6909H	157	U 70999A	243	U 724	185	U 7319M	167	U 7401MC <small>NEW</small>	164
U 6202AR	225	U 6909M	157	U 710	185	U 724G	184	U 7319MP	377	U 7402C <small>NEW</small>	163
U 6212	225	U 690A	551	U 710G	184	U 724J <small>NEW</small>	185	U 7319MT	166	U 7402MC <small>NEW</small>	164
U 6212R	225	U 690AN	551	U 710I <small>NEW</small>	185	U 724S	186	U 7320	165	U 7409M	164
U 6212RR	225	U 690F	550	U 710S	186	U 724SI <small>NEW</small>	186	U 7320H	165	U 74101	163
U 6222	225	U 691	547	U 710SI <small>NEW</small>	186	U 72-5/16	313	U 7320HD	167	U 74102	163
U 6222R	225	U 69106	157	U 710V	328	U 7270P	181	U 7320M	167	U 74104	163
U 6222RR	225	U 6910H	157	U 710WO	186	U 7271	180	U 7320MT	166	U 74106	163
U 6223	225	U 6910M	157	U 712	185	U 7272	180	U 73212M	167	U 7410M	164
U 6223P	225	U 6911H	157	U 712G	184	U 72900W	162	U 73214M	167	U 7410MT	164
U 6223T	225	U 6911M	157	U 712I <small>NEW</small>	185	U 7290-1/2	162	U 7321M	167	U 7411M	164
U 6224	225	U 6912H	157	U 712S	186	U 7290-1/4	162	U 7321MP	377	U 7411MT	164
U 6224P	225	U 6912M	157	U 712SC	186	U 729010W	162	U 7321MPR	377	U 7412	163
U 6224T	225	U 6913M	157	U 712SI <small>NEW</small>	186	U 729015W	162	U 7321MT	166	U 7412H	163
U 6225	225	U 6914H	157	U 712V	328	U 729020W	162	U 7322	165	U 7412M	164
U 6225PE	225	U 6914M	157	U 715	185	U 729025W	162	U 7322H	165	U 7412MT	164
U 6225PS	225	U 6915M	157	U 715G	184	U 729027W	162	U 7322HD	167	U 7413M	164
U 6225T	225	U 6916H	157	U 715I <small>NEW</small>	185	U 7290-3/8	162	U 7322M	167	U 7413MT	164
U 6226	225	U 6918H	157	U 715S	186	U 729030W	162	U 7322MT	166	U 7414	163
U 6232	225	U 691F	550	U 715SI <small>NEW</small>	186	U 729040W	162	U 7323M	167	U 74143	156
U 6232R	225	U 69206	157	U 715V	328	U 729045W	162	U 7323MT	166	U 7414H	163
U 6232RR	225	U 6920H	157	U 7175P	180	U 7290-5/16	162	U 7324	165	U 7414M	164
U 6234	225	U 69212	158	U 7176P	180	U 7290-5/32	162	U 7324H	165	U 7414MT	164
U 6234R	225	U 692F	550	U 718	185	U 729050W	162	U 7324HD	167	U 74150	169
U 6242	225	U 6962	180	U 7180P	180	U 7290-5M	162	U 7324M	167	U 7415M	164
U 6242R	225	U 6965	180	U 7181P	180	U 7290-6M	162	U 7324MT	166	U 7415MT	164
U 6242RR	225	U 6970	181	U 7184P	180	U 7290-8M	162	U 7325M	167	U 7416	163
U 6252	225	U 6971	180	U 718G	184	U 730	185	U 7326	165	U 7416H	163
U 6252R	225	S 70	393	U 718I <small>NEW</small>	185	U 7300MP	377	U 7326HD	167	U 7416M	164
U 6262R	225	U 7007M	160	U 718S	186	U 7301C <small>NEW</small>	165	U 7326M	167	U 7416MT	164
P 62CA <small>NEW</small>	669	U 7008M	160	U 718SI <small>NEW</small>	186	U 7302MC <small>NEW</small>	167	U 7327M	167	U 741719M	377
U 6310	225	U 7009M	160	S 72	393	U 7308M	167	U 7327MT	166	U 7417M	164
P 63CA <small>NEW</small>	669	U 7010M	160	U 7200S	359	U 7309M	167	U 7328	165	U 7417MT	164
U 6500X	596	U 7010MHM	161	U 7208H	159	U 7310M	167	U 7328H	165	U 7418	163
U 6501X	596	U 7011M	160	U 7208M	159	U 7310MT	166	U 7328HD	167	U 7418H	163
U 6505HM	158	U 7012M	160	U 7209H	159	U 73112	165	U 7328M	167	U 7418M	164
U 6506HM	158	U 7013M	160	U 7209M	159	U 73112D	167	U 7328P	377	U 7418MT	164
U 6507HM	158	U 7013MHM	161	U 72-1/4	313	U 7311M	167	U 7329M	167	U 741921M	377
U 6508H	158	U 7014M	160	U 7210H	159	U 7311MT	166	U 7330	165	U 741921MT	378
U 6508HM	158	U 7015M	160	U 7210M	159	U 7312	165	U 7330H	165	U 7419M	164
U 6509HM	158	U 7016M	160	U 7210MHM	161	U 7312H	165	U 7330HD	167	U 7419MT	164
U 6510HM	158	U 7017M	160	U 7211M	159	U 7312M	167	U 7330M	167	U 7420	163
U 6511H	158	U 7018M	160	U 7212H	159	U 7312MT	166	U 7332	165	U 74201	164
U 6511HM	158	U 7019M	160	U 7212HM	161	U 7313M	167	U 7332H	165	U 74202M	164
U 6512HM	158	U 7021M	160	U 7212M	159	U 7313MD	168	U 7332HD	167	U 74203	166
U 6513HM	158	U 7022M	160	U 7213M	159	U 7313MT	166	U 7332M	167	U 74204M	164
U 6514HM	158	U 7023M	160	U 7213MHM	161	U 7314	165	U 7334	165	U 74206	164
U 6515HM	158	U 7024M	160	U 7214H	159	U 7314H	165	U 7334H	165	U 7420H	163
U 652X	596	U 704	185	U 7214HM	161	U 7314M	167	U 7334HD	167	U 7420M	164
U 653X	596	U 704G	184	U 7214M	159	U 7314MT	166	U 7334M	167	U 7420MT	164
U 654X	596	U 704S	186	U 7215M	159	U 7315M	167	U 7335M	167	U 74216	167
U 656X	596	U 706	185	U 7216H	159	U 7315MT	166	U 7336	165	U 7421M	164
U 684	546	U 706G	184	U 7216HM	161	U 7316	165	U 7336H	165	U 7421MT	164
U 685 <small>NEW</small>	546	U 706I <small>NEW</small>	185	U 7216M	159	U 7316H	165	U 7336HD	167	U 7422	163
U 689	551	U 706S	186	U 7217M	159	U 7316HD	167	U 7336M	167	U 7422H	163
U 689AR	551	U 706SI <small>NEW</small>	186	U 7218H	159	U 7316M	167	U 7338	165	U 7422M	164
U 690	551	U 706WO	186	U 7218M	159	U 7316MT	166	U 7340	165	U 7422MT	164
U 6904M	157	U 708	185	U 7219M	159	U 7317M	167	U 7340H	165	U 7422S	168
U 69055M	157	U 708G	184	U 72202	159	U 7317MP	377	U 7342	165	U 7423M	164
U 6905M	157	U 708I <small>NEW</small>	185	U 7220H	159	U 7317MT	166	U 7344	165	U 7423MT	164
U 6906H	157	U 708S	186	U 72212	160	U 7318	165	U 7348	165	U 7424	163
U 6906M	157	U 708SI <small>NEW</small>	186	U 72216	160	U 7318H	165	U 7400CA	162	U 742426	377
U 6907M	157	U 708V	328	U 7222H	159	U 7318HD	167	U 7400DE	377	U 742426T	378
U 6908H	157	U 708WO	186	U 7224H	159	U 7318M	167	U 7400SWL	359	U 7424H	163



ITEM	PAGE	ITEM	PAGE	ITEM	PAGE	ITEM	PAGE	ITEM	PAGE	ITEM	PAGE
u7424M	164	u750012LH	156	u7523	170	u7567B	180	u799UR	348	u814DI	352
u7424MT	164	u750013MLH	156	u7523L	172	u7568	180	u7A	33	u814HD	350
u74250	169	u750015	171	u7523LD	173	u7568B	180	u7B	33	u814UI	350
u7425M	164	u7500LD	173	u7523M	171	u7569	180	u800110DV	440	u81516	210
u7426	163	u7500P1	182	u7523ML	173	u7570	181	u800110EX	440	u81617	210
u7426H	163	u7500R1	182	u7524	170	u7570B	181	u800110IN	439	u8180	209
u7426M	164	u7501C <sup>NEW</sup>	170	u7524L	172	u7590-1	174	u800112DV	440	u8181	209
u7427M	164	u7501MC <sup>NEW</sup>	171	u7524LD	173	u7590-1/2	174	u800112EX	440	u8182	209
u7428	163	u7502C <sup>NEW</sup>	172	u7524M	171	u759012M	174	u800112IN	439	u8183	209
u7428H	163	u7508	170	u7524ML	173	u759014M	174	u80016DV	440	u8184	209
u7428M	164	u7508L	172	u7525	170	u759017M	174	u80016EX	440	u8185	209
u7429M	164	u7509	170	u75250	174	u759019M	174	u80016IN	439	u8186	209
u7430	163	u7509L	172	u7525L	172	u759022M	174	u80018DV	440	u818A	349
u74300	168	u7510	170	u7525M	171	u759024M	174	u80018EX	440	u818AO	351
u7430H	163	u7510L	172	u7525ML	173	u7590-3/4	174	u80018IN	439	u818AUR	349
u7430M	164	u7511	170	u7526	170	u7590-5/8	174	u800212	440	u818B	351
u7432	163	u7512	170	u7526L	172	u7590-7/8	174	u800310	441	u818BI	352
u7432H	163	u7512L	172	u7526M	171	u7590-9/16	174	u800312	441	u818C	351
u7432M	164	u7512LD	173	u7526ML	173	u7648	179	u800316	441	u818CI	352
u7433M	164	u7513	170	u7527	170	u7650	179	u80038	441	u818D	351
u7434	163	u7513L	172	u7527L	172	u7650L	394	u80047	440	u818DI	352
u7434H	163	u7513LD	173	u7527M	171	u7650S	394	u801	348	u818HD	350
u7434M	164	u7513S	174	u7527ML	173	u7651	179	u801UI	348	u818UI	350
u7436	163	u7514	170	u7528	170	u7651C	394	u802	349	u81922	210
u7436H	163	u7514L	172	u7528L	172	u7651N	394	u808B	351	u82	393
u7436M	164	u7514LD	173	u7528M	171	u7652	179	u808BI	352	u8200	234
u7438	163	u7515	170	u7529	170	u7652B	179	u808C	351	u8200M	234
u7438H	163	u75150	174	u7529L	172	u7652C	394	u808CI	352	u8205M	234
u7440	163	u7515L	172	u7529M	171	u7653	179	u808D	351	u8206	234
u74400	168	u7515LD	173	u7530	170	u7655	179	u808DI	352	u8206M	234
u7440H	163	u7516	170	u7530L	172	u7655B	179	u808HD	350	u8207M	234
u7441-1/2	169	u7516L	172	u7530M	171	u7656	179	u808UI	350	u8208	234
u7441-1/4	169	u7516LD	173	u7530ML	173	u7656B	179	u80911	210	u8208M	234
u7441-10M	169	u7516S	174	u7531	170	u7657	181	u8100C	209	u8209M	234
u7441-14M	169	u7517	170	u7531L	172	u7657RK	181	u8100CM	210	u8210	234
u7441-17M	169	u7517L	172	u7531M	171	u767	342	u81011	210	u8210M	234
u744125W	168	u7517LD	173	u7532	170	u768	342	u810A	349	u8211M	234
u7441-3/4	169	u7517M	171	u7532L	172	u77	393	u810AUR	349	u8212	234
u7441-3/8	169	u7517S	174	u7532M	171	u7710	160	u810B	351	u8212M	234
u744130W	168	u7518	170	u7532ML	173	u7710H	160	u810BI	352	u8213M	234
u744140W	168	u7518L	172	u7533	170	u7712H	160	u810C	351	u8214	234
u744145W	168	u7518LD	173	u7533M	171	u7712HM	161	u810CI	352	u8216	234
u7441-5/16	169	u7518S	174	u7533ML	173	u7714H	160	u810D	351	u823	209
u7441-5/8	169	u7519	170	u7534	170	u7714HM	161	u810DI	352	u82426	210
u744150W	168	u7519L	172	u7534M	171	u7716H	160	u810HD	350	u824A	349
u744155W	168	u7519LD	173	u7534ML	173	u7716HM	161	u810UI	350	u824AUR	349
u744160W	168	u7519M	171	u7535	170	u7718H	160	u81213	210	u824B	351
u7441-6M	169	u7519ML	173	u7535M	171	u7720H	160	u81215	210	u824BI	352
u7441-8M	169	u7520	170	u7535ML	173	u7722H	160	u812B	351	u824C	351
u7442	163	u7520L	172	u7536	170	u7724H	160	u812BI	352	u824CI	352
u7442H	163	u7520LD	173	u7536M	171	u78	393	u812C	351	u824D	351
u7444	163	u7520M	171	u7536ML	173	u79	393	u812CI	352	u824DI	352
u7444H	163	u7520ML	173	u7537ML	173	u794C	348	u812D	351	u824HD	350
u7446	163	u7521	170	u7538	170	u795	185	u812DI	352	u824UI	350
u7446H	163	u7521L	172	u7538M	171	u795C	348	u812HD	350	u825	209
u7448	163	u7521LD	173	u7538ML	173	u795G	184	u812UI	350	u829	209
u7448H	163	u7521M	171	u7540M	171	u795S	186	u81314	210	u830	209
u7470P	181	u7521MFP	377	u7541M	171	u795UR	348	u81415	210	u831	209
u7472	180	u7521ML	173	u7541ML	173	u796C	348	u814A	349	u8310W	233
u74ET17	168	u7522	170	u7542M	171	u796UR	348	u814AUR	349	u8315W	233
u74HLR	359	u7522L	172	u7543M	171	u797C	348	u814B	351	u832	209
u75	393	u7522LD	173	u7543ML	173	u797UR	348	u814BI	352	u8320W	233
u750010	170	u7522M	171	u7546M	171	u798C	348	u814C	351	u8325W	233
u750010L	172	u7522MFP	377	u7550M	171	u798UR	348	u814CI	352	u8327W	233
u750011ML	173	u7522ML	173	u7567	180	u799C	348	u814D	351	u833	209

ITEM	PAGE	ITEM	PAGE	ITEM	PAGE	ITEM	PAGE	ITEM	PAGE	ITEM	PAGE
u8330W	233	u8600E	233	u8816	233	s926	292	u9486	236	u9601D	237
u836A	349	u8600F	233	u8843	233	s926V	332	u9487	236	u9601F	237
u836AUR	349	u8602	233	u886	376	s927	292	u9488	236	u9602	237
u836B	351	u8604	233	u887	376	s928V	332	u9489	236	u9602R	239
u836BI	352	u8606	233	u888	374	s929	292	s950	294	u9604	237
u836C	351	u8608	233	s8S	320	u9300MS	246	u95001	358	u9604R	239
u836CI	352	u860HD	350	s906	296	u9300TF	231	u95002	358	u9606	237
u836D	351	u8616	233	u90616	534	u9300V	330	u95003	358	u9606R	239
u836DI	352	u8624	233	u90624	534	u9301CMS	245	u95004	358	u9608	237
u836HD	350	u8626	233	u90632	534	u9302CMS	245	u95005	358	u9608R	239
u836UI	350	u8631	233	s908	292	u9307F	244	u9500A	359	u96-1/2	315
u83W	233	u8632	233	s910	296	u9308	246	u9500B	358	u96-1/4	315
s8412	349	u8634	233	u9100GA	232	u9308L	244	u9500BC	246	u9616	237
u848B	351	u8635	233	u9100GB	232	u9308M	244	u9500BF	246	u9616R	239
u848BI	352	u8636	233	u9100GC	232	u9308S	244	u9500BG	246	u9622	237
u848C	351	u8643	233	u9101GC	232	s931	291	u9500BT	246	u9622R	239
u848CI	352	u8652	233	u9104G	232	u9310CMS	245	u9500LD	522	u9623	237
u848D	351	u8671	233	u9106G	232	u9310W	237	u9501A	359	u9624	237
u848DI	352	u8680	233	u9108G	232	u9314MS	245	u9501BC	246	u9624R	239
u848HD	350	u8682	233	u9112G	232	u9315MH	245	u9501BG	246	u9625	237
u848UI	350	u8683	233	u9116G	232	u9315MM	244	u9501BT	246	u9626	237
u850	353	u8684	233	u9143G	232	u9315MS	245	u9503B	246	u9627	237
u850-1	354	u8685	233	u916404	440	u9315MT	245	u9504B	246	u96-3/4	315
u850-1 1/2	354	u8686	233	u916406	440	u9315W	237	u9505B	246	u96-3/8	315
u850-1 1/2P	354	u8687	233	u9182G	232	u9320W	237	u9506B	246	u9631	237
u850-1 1/4	354	u8688	233	u9184G	232	u9325W	237	u9507B	246	u9632	237
u850-1 1/4P	354	u86A	312	u9186G	232	u9327W	237	u9508B	246	u9632R	239
u850-1/2	354	u86A-1/2	312	u9187G	232	u9330W	237	u9509B	246	u9633	237
u850-1/2P	354	u86A-1/4	312	u9188G	232	s936	291	s951	294	u9634	237
u850-1/4	354	u86A-1X12	312	u9190G	232	s938	295	u9510B	246	u9634R	239
u850-1/4P	354	u86A-1X8	312	u9191G	232	u939W	237	u9511B	246	u9635	237
u850-1P	354	u86A-3/16	312	u9200B	238	s940	295	u9512B	246	u9635R	239
u850-2	354	u86A-3/4X12	312	u9201B	238	u9400A	236	u9513B	246	u9636	237
u850-2P	354	u86A-3/4X8	312	u9204M	238	u9400D	236	u9514B	246	u9642	237
u850-3/4	354	u86A-3/8	312	u9205M	238	u9401D	236	u9515B	246	u9643	237
u850-3/4P	354	u86A-5/16	312	u9206	238	u9402	236	u9516B	246	u9643R	239
u850-3/8	354	u86A-5/8	312	u9206M	238	u9404	236	u9517B	246	u96-5/16	315
u850-3/8P	354	u86A-7/16	312	u9206MTV	329	u9406	236	u9518B	246	u96-5/8	315
s8508	351	u86A-7/8X12	312	u9206TV	329	u9408	236	s952	294	u9652	237
u850HA	354	u86A-7/8X8	312	u9207	238	u9410	236	u9521	359	u9652R	239
u850RH	354	u86B	312	u9207M	238	u9412	236	u9522	359	s966	292
u851	353	u86C	312	u9207MTV	329	u9416	236	u9523	359	s967	292
s8510	351	u86D	312	u9208	238	s942	295	u9524	359	u96-7/16	315
s851011	210	u86E	311	u9208M	238	u9421	236	u9525	359	u9671	237
s8510A	350	u86G-1/2	311	u9208MTV	329	u9422	236	u9526	359	u9671R	239
s8512	351	u86G-1X12	311	u9208TV	329	u9423	236	u9527	359	u967V	332
s8512A	350	u86G-3/4X12	311	u9209	238	u9424	236	u9528	359	s968	292
s851314	210	u86G-5/8	311	u9209M	238	u9425	236	u9529	359	u9680	237
s8514	351	u86G-7/8X12	311	u9209MTV	329	u9431	236	s953	294	u9680R	239
s8514A	350	u86MN4	494	u9210	238	u9432	236	s954	294	u9682	237
s851617	210	u86MN5	494	u9210M	238	u9434	236	s955	294	u9682R	239
s8518	351	u86P-1/2	311	u9210MTV	329	u9435	236	s956	294	u9683	237
s8518A	350	u86P-1X12	311	u9211	238	u9436	236	s957	294	u9683R	239
s851922	210	u86P-1X8	311	u9211M	238	s945	292	s95P3	294	u9684	237
u852	353	u86P-3/4X8	311	u9211MTV	329	u9452	236	u9600A	237	u9684R	239
s852124	322	u86P-5/8	311	u9212	238	s946	292	u9600AR	239	u9685	237
s8524	351	u86P-7/8X8	311	u9212M	238	s946V	332	u9600B	237	u9685R	239
s852426	210	u87F20	515	u9213M	238	s947	292	u9600BR	239	u9686	237
s8524A	350	u87G22	515	u9214	238	u9471	236	u9600C	237	u9686R	239
u853	353	u87P14	515	u9216	238	s948	294	u9600D	237	u9687	237
s8536	351	u8804	233	u9218	238	u9481	236	u9600DR	239	u9688	237
s8548	351	u8806	233	u9230M	238	u9482	236	u9600E	237	u9688R	239
u8600A	233	u8808	233	u9231M	238	u9483	236	u9600ER	239	u9689	237
u8600B	233	u8810	233	s925	292	u9484	236	u9600G	237	s968V	332
u8600D	233	u8812	233	u9255M	238	u9485	236	u9601B	237	u96A	315

ITEM	PAGE	ITEM	PAGE	ITEM	PAGE	ITEM	PAGE	ITEM	PAGE	ITEM	PAGE
u96G-1/2	314	u98240	31	u9991	398	SAZFL1 <small>NEW</small>	574	uB30MM	531	uBC1/4	524
u96G-3/4	314	u98241	31	u9991A	398	SAZFL2 <small>NEW</small>	574	uB31/64	528	uBC1/8	524
u96G-5/8	314	u98300	29	u9992	86	SAZFL3 <small>NEW</small>	574	uB35MM	531	uBC100M	527
u9700	331	u98320M	29	u9995	398	SAZMLO <small>NEW</small>	574	uB40MM	531	uBC105M	527
u9700B	330	u98322M	29	u9995A	398	SAZML1 <small>NEW</small>	574	uB45MM	531	uBC10M	527
u9700BA	330	u9842	237	u9996	86	SAZML2 <small>NEW</small>	574	uB5/16	528	uBC11/32	524
u9700BV <small>NEW</small>	330	u9843	237	u9997	86	SAZML3 <small>NEW</small>	574	uB5/32	528	uBC11/64	524
u9700C	331	S985	285	u99B	315	uB1/16	528	uB5/64	528	uBC110M	527
u9700T	329	u9888	243	uA01M	110	uB1/2	528	uB5/8	528	uBC115M	527
u9700TA	329	u9906	30	SA01S	107	uB1/32	528	uB50MM	531	uBC120M	527
u9700TSA	329	u9906M	31	SA02C	102	uB1/4	528	uB55MM	531	uBC125M	527
u9701	331	u9907	30	SA02M	104	uB1/64	528	uB60MM	531	uBC13/32	524
u9701B	330	u9907M	31	SA02S	103	uB1/8	528	uB65MM	531	uBC13/64	524
u9701T	329	u9910	30	SA03M <small>NEW</small>	101	uB100MM	531	uB7/16	528	uBC130M	527
u9702	331	u9911	30	SA03S <small>NEW</small>	101	uB105MM	531	uB7/32	528	uBC15/32	524
u9702B	330	u9914M	31	SAADT01	354	uB10MM	531	uB7/64	528	uBC15/64	524
u9702T	329	u9915	31	uA1i018 <small>NEW</small>	475	uB11/16	528	uB70MM	531	uBC15M	527
u9703T	329	u9915M	31	uA1820 <small>NEW</small>	476	uB11/32	528	uB75MM	531	uBC17/64	524
u9713	331	u9920	69	SALLF10	255	uB11/64	528	uB80MM	531	uBC19/64	524
u9713A	331	u99200	28	SALLF10M	256	uB110MM	531	uB85MM	531	uBC20M	527
u9713B	330	u99201	28	SALLF13	255	uB115MM	531	uB9/16	528	uBC21/64	524
u9713T	329	u9921	69	SALLF13M	256	uB11MM	531	uB9/32	528	uBC23/64	524
u9714	331	u99210M	29	SALLF25	254	uB120MM	531	uB9/64	528	uBC25/64	524
u9714B	330	u99211M	29	SALLF30	254	S122063	438	uB90MM	531	uBC25M	527
u9714T	329	S993	299	SALLF7	255	S122064	438	uB95MM	531	uBC27/64	524
u9715	331	u99300	28	SALLF7M	256	S122065	438	uBA18U <small>NEW</small>	475	uBC29/64	524
u9715B	330	u99301	28	SALLFN9	259	S122070	438	uBA204 <small>NEW</small>	476	uBC3/16	524
u9715T	329	S994	299	SALLFN9M	259	S122071	438	uBAC3	45	uBC3/32	524
u9716	331	u99400	28	SALLFNP10	262	S122080	438	uBAC5	45	uBC3/4	524
u9716B	330	u99401	28	SALLFNP10M	262	S122081	438	SBAF100	309	uBC3/8	524
u9716T	329	u99430M	27	SALLFNX8	260	S122082	438	SBAF125	309	uBC30M	527
u972	402	u99431M	27	SALLFNX8M	261	S122085	437	SBAF150	309	uBC31/64	524
u973	391	S995	300	SALLFT9	256	S122086	437	SBAF150G	308	uBC32M	527
u974	391	u99500	28	SALLFTL7	256	S122087	437	SBAF175	309	uBC35M	527
S975	285	u99510	27	SALLFTN8	259	uB125MM	531	SBAF175G	308	uBC40M	527
S976	285	u99512	27	SALLFTNA7	259	uB12MM	531	SBAF200	309	uBC45M	527
S977	292	u99520	25	SALLFTNP8	262	uB13/32	528	uBAG3	45	uBC5/16	524
S978	292	u99521	25	SALLFTNX8	261	uB13/64	528	uBAI204 <small>NEW</small>	474	uBC5/32	524
S979	292	u99540M	29	uAPM5A	560	uB130MM	531	uBAI208 <small>NEW</small>	474	uBC5/64	524
S979R	292	u99550	27	uAPM5B	560	uB13MM	531	uBAMA9	460	uBC5/8	524
u980	388	u99552	27	uAPM5W	560	uB14MM	531	uBAMP8	460	uBC50M	527
u9800A	237	u99620	25	uAPMA1	560	uB15/32	528	uBAMP9	460	uBC52M	527
u9800AR	239	u99621	25	uAPMA11	560	uB15/64	528	SBAVN1/16 <small>NEW</small>	530	uBC55M	527
u9803	237	u99622	25	uAPMA1X	561	uB15MM	531	SBAVN1/2 <small>NEW</small>	530	uBC60M	527
u9804	237	S997	299	uAPMA24	560	uB16MM	531	SBAVN1/4 <small>NEW</small>	530	uBC65M	527
u9804R	239	u99710	27	uAPMA3	560	uB17/32	528	SBAVN1/8 <small>NEW</small>	530	uBC7/16	524
u9805	237	u99711A	27	uAPMA36	560	uB17/64	528	SBAVN11/32 <small>NEW</small>	530	uBC7/32	524
u98051	30	u99712B	25	uAPMA3F	561	uB17MM	531	SBAVN11/64 <small>NEW</small>	530	uBC7/64	524
u98052	30	u99720	24	uAPMA3X	561	uB18MM	531	SBAVN13/32 <small>NEW</small>	530	uBC70M	527
u9806	237	u99721	24	uAPMA5	560	uB19/32	528	SBAVN13/64 <small>NEW</small>	530	uBC75M	527
u9806R	239	u99730	26	uAPMB5	561	uB19/64	528	SBAVN15/32 <small>NEW</small>	530	uBC80M	527
u9808	237	u99731B	26	uAPMB53	561	uB19MM	531	SBAVN15/64 <small>NEW</small>	530	uBC85M	527
u9808R	239	u99742	24	uAPMB81	561	uB20MM	531	SBAVN17/64 <small>NEW</small>	530	uBC9/16	524
u9810	237	u99771	26	uAPMB97	561	uB21/32	528	SBAVN3/16 <small>NEW</small>	530	uBC9/32	524
u98101	34	u99772	26	uAPMW188	561	uB21/64	528	SBAVN3/32 <small>NEW</small>	530	uBC9/64	524
u98111	34	u9980	73	uAPMW220	561	uB23/64	528	SBAVN3/8 <small>NEW</small>	530	uBC90M	527
u9812	237	u9980P	74	uAPMW222	561	uB25/64	528	SBAVN5/16 <small>NEW</small>	530	uBC95M	527
u98121	34	u9981	73	uAPMW222X	561	uB25MM	531	SBAVN5/32 <small>NEW</small>	530	uBCEN1	534
u9812R	238	u9982	72	uAPMW222F	561	uB27/64	528	SBAVN7/16 <small>NEW</small>	530	uBCEN2	534
u98131	34	u99820	24	SARE3 <small>NEW</small>	370	uB29/64	528	SBAVN7/32 <small>NEW</small>	530	uBCEN3	534
u98152	28	u99822	24	SARE4 <small>NEW</small>	370	uB3/16	528	SBAVN7/64 <small>NEW</small>	530	uBCEN4	534
u9816	237	u9983	72	SAVE14 <small>NEW</small>	343	uB3/32	528	SBAVN9/32 <small>NEW</small>	530	uBCEN5	534
u98165	37	u9984	397	uAX28	569	uB3/4	528	SBAVN9/64 <small>NEW</small>	530	uBCEN6	534
u98166 <small>NEW</small>	32	u9985	397	uAX9	569	uB3/64	528	uBC1/16	524	uBCEN7	534
u9816R	239	u9988	397 704	S AZFLO <small>NEW</small>	574	uB3/8	528	uBC1/2	524	uBCEN8	534

ITEM	PAGE	ITEM	PAGE	ITEM	PAGE	ITEM	PAGE	ITEM	PAGE	ITEM	PAGE
BCLO	687	BCO9/64	525	BGB1/2	530	BLTF	531	BMG1-1/8	519	BNM41	532
BCM10 <small>NEW</small>	534	BDL12	379	BGB1/4	530	BLTG	531	BMG3/4	519	BNM42	532
BCN1212	517	BF1	518	BGB1/8	530	BLTH	531	BMG3/8	519	BNM43	532
BCN126	517	BF1-1/2	518	BGB11/64	530	BLTI	531	BMG5/16	519	BNM44	532
BCN1412	517	BF1-1/4	518	BGB13/64	530	BLTJ	531	BMG5/8	519	BNM45	532
BCN144	517	BF1-1/8	518	BGB3/16	530	BLTK	531	BMG7/16	519	BNM46	532
BCN146	517	BF1-3/4	518	BGB3/32	530	BLTL	531	BMG7/8	519	BNM47	532
BCN183	517	BF1-3/8	518	BGB3/4	530	BLTM	531	BMG9/16	519	BNM48	532
BCN3164	517	BF2	518	BGB3/8	530	BLTN	531	BMM1	519	BNM49	532
BCN3166	517	BF5130S	383	BGB5/16	530	BLTO	531	BMM1/2	519	BNM5	532
BCN3412	517	BF51T20	124	BGB5/32	530	BLTP	531	BMM1/4	519	BNM50	532
BCN346	517	BF51T27	124	BGB5/8	530	BLTQ	531	BMM1-1/2	519	BNM51	532
BCN3812	517	BF51T30	124	BGB7/16	530	BLTR	531	BMM1-1/4	519	BNM52	532
BCN386	517	BF51T40	124	BGB7/32	530	BLTS	531	BMM1-1/8	519	BNM53	532
BCN51612	517	BF51T45	124	BGB7/64	530	BLTU	531	BMM1-3/8	519	BNM54	532
BCN5164	517	BF51T47	124	BGB9/16	530	BLTV	531	BMM3/4	519	BNM55	532
BCN5166	517	BF51T50	124	BGB9/32	530	BLTW	531	BMM3/8	519	BNM56	532
BCN5812	517	BF51T55	124	BGB9/64	530	BLTX	531	BMM5/16	519	BNM57	532
BCN586	517	BF51T60	124	BH1/16	522	BLTY	531	BMM5/8	519	BNM58	532
BCN7812	517	BF583234	383	BH1/2	522	BLTZ	531	BMM7/16	519	BNM59	532
BCN786	517	BG1/16	529	BH1/4	522	BM1 <small>NEW</small>	519	BMM7/8	519	BNM6	532
BCO1/16	525	BG1/2	529	BH1/8	522	BM1/2 <small>NEW</small>	519	BN129	92	BNM60	532
BCO1/2	525	BG1/32	529	BH11/32	522	BM1/4 <small>NEW</small>	519	BN132	92	BNM61	532
BCO1/32	525	BG1/4	529	BH11/64	522	BM3/4 <small>NEW</small>	519	BN133	92	BNM62	532
BCO1/4	525	BG1/64	529	BH13/32	522	BM3/8 <small>NEW</small>	519	BN134	92	BNM63	532
BCO1/64	525	BG1/8	529	BH13/64	522	BM5/16 <small>NEW</small>	519	BN136	92	BNM64	532
BCO1/8	525	BG11/16	529	BH15/32	522	BM5/8 <small>NEW</small>	519	BN137	92	BNM65	532
BCO11/16	525	BG11/32	529	BH15/64	522	BM7/16 <small>NEW</small>	519	BN138	92	BNM66	532
BCO11/32	525	BG11/64	529	BH17/64	522	BM7/8 <small>NEW</small>	519	BN139	93	BNM67	532
BCO11/64	525	BG13/32	529	BH19/64	522	BM9/16 <small>NEW</small>	519	BN140	92	BNM68	532
BCO13/32	525	BG13/64	529	BH21/64	522	BMAX11/2X21	515	BN142	93	BNM69	532
BCO13/64	525	BG15/32	529	BH23/64	522	BMAX11/2X36	515	BN143	93	BNM7	532
BCO15/32	525	BG15/64	529	BH25/64	522	BMAX11/4X21	515	BNL	443	BNM70	532
BCO15/64	525	BG17/32	529	BH27/64	522	BMAX11/4X36	515	BNM1	532	BNM71	532
BCO17/32	525	BG17/64	529	BH29/64	522	BMAX11/8X13	515	BNM10	532	BNM72	532
BCO17/64	525	BG19/32	529	BH3/16	522	BMAX11/8X21	515	BNM11	532	BNM74	532
BCO19/32	525	BG19/64	529	BH3/32	522	BMAX11/8X36	515	BNM12	532	BNM75	532
BCO19/64	525	BG21/32	529	BH3/8	522	BMAX13/4X21	515	BNM13	532	BNM76	532
BCO21/32	525	BG21/64	529	BH31/64	522	BMAX13/4X36	515	BNM14	532	BNM77	532
BCO21/64	525	BG23/64	529	BH5/16	522	BMAX13/8X21	515	BNM15	532	BNM78	532
BCO23/64	525	BG25/64	529	BH5/32	522	BMAX13/8X36	515	BNM17	532	BNM79	532
BCO25/64	525	BG27/64	529	BH5/64	522	BMAX1X13	515	BNM18	532	BNM8	532
BCO27/64	525	BG29/64	529	BH7/16	522	BMAX1X21	515	BNM19	532	BNM80	532
BCO29/64	525	BG3/16	529	BH7/32	522	BMAX1X36	515	BNM2	532	BNM9	532
BCO3/16	525	BG3/32	529	BH7/64	522	BMAX3/4X13	515	BNM21	532	BORE3 <small>NEW</small>	370
BCO3/32	525	BG3/4	529	BH9/32	522	BMAX3/4X21	515	BNM22	532	BORE4 <small>NEW</small>	370
BCO3/4	525	BG3/64	529	BH9/64	522	BMAX3/4X36	515	BNM23	532	BORE6 <small>NEW</small>	370
BCO3/64	525	BG3/8	529	P BICS20	653	BMAX5/8X13	515	BNM24	532	BP1	519
BCO3/8	525	BG31/64	529	P BICS25	653	BMAX5/8X21	515	BNM25	532	BP1 1/2	519
BCO31/64	525	BG33/64	529	P BICS30	653	BMAX5/8X36	515	BNM26	532	BP1 1/4	519
BCO33/64	525	BG35/64	529	P BICS35	653	BMAX7/8X13	515	BNM27	532	BP1 1/8	519
BCO35/64	525	BG37/64	529	P BICS40	653	BMAX7/8X21	515	BNM28	532	BP1/2	519
BCO37/64	525	BG39/64	529	BL61A	492	BMAX7/8X36	515	BNM29	532	BP1/4	519
BCO39/64	525	BG41/64	529	BL70A	492	BME1	533	BNM30	532	BP3/4	519
BCO41/64	525	BG43/64	529	BL90A	492	BME2	533	BNM31	532	BP3/8	519
BCO43/64	525	BG5/16	529	BLC12	308	BME3	533	BNM32	532	BP5/16	519
BCO5/16	525	BG5/32	529	BLC17	308	BME4	533	BNM33	532	BP5/8	519
BCO5/32	525	BG5/64	529	BLC25	308	BME5	533	BNM34	532	BP7/16	519
BCO5/64	525	BG5/8	529	BLC36	308	BME6	533	BNM35	532	BP7/8	519
BCO5/8	525	BG7/16	529	BLC48	308	BME7	533	BNM36	532	BR1201	520
BCO7/16	525	BG7/32	529	BLTA	531	BMG1	519	BNM37	532	BR1202	520
BCO7/32	525	BG7/64	529	BLTB	531	BMG1/2	519	BNM38	532	BR1203	520
BCO7/64	525	BG9/16	529	BLTC	531	BMG1/4	519	BNM39	532	BR1204	521
BCO9/16	525	BG9/32	529	BLTD	531	BMG1-1/2	519	BNM4	532	BR1205	520
BCO9/32	525	BG9/64	529	BLTE	531	BMG1-1/4	519	BNM40	532	BR1206	520

ITEM	PAGE	ITEM	PAGE	ITEM	PAGE	ITEM	PAGE	ITEM	PAGE	ITEM	PAGE
BR1207	520	BS5/16 NEW	526	BSDS5/16X18	516	BZC1-13/16	533	C25S40	664	C614 NEW	535
BR1401	521	BS5/32 NEW	526	BSDS5/16X4	516	BZC13/16	533	C27C35	667	C615 NEW	535
BR1402	521	BS5/64 NEW	526	BSDS5/16X6	516	BZC1-3/8	533	C27C40	667	C620 NEW	540
BR1403	521	BS5/8 NEW	526	BSDS5/16X8	516	BZC15/16	533	C27R35	667	C621 NEW	540
BR1404	520	BS50M NEW	527	BSDS5/8X12	516	BZC1-7/16	533	C27R40	667	C623 NEW	538
BR1405	520	BS52M NEW	527	BSDS5/8X18	516	BZC1-7/8	533	C460	214	C624 NEW	538
BR1406	520	BS55M NEW	527	BSDS5/8X24	516	BZC3/4	533	C500	536	C627 NEW	537
BR1407	520	BS60M NEW	527	BSDS5/8X6	516	BZC5/8	533	C501	536	C628 NEW	537
BR1408	520	BS65M NEW	527	BSDS5/8X8	516	BZC7/8	533	C502	536	C629 NEW	537
BR1409	520	BS7/16 NEW	526	BSDS7/32X6	516	BZL1/2	533	C503	536	C630 NEW	540
BR1410	520	BS7/32 NEW	526	BSDS7/8X10	516	BZL1/4	533	C504	536	C800	535
BR1411	520	BS7/64 NEW	526	BSDS7/8X12	516	BZL1/8	533	C505	536	C801	535
BR1412	520	BS70M NEW	527	BSDS7/8X18	516	BZL11/32	533	C5115	524	C802	535
BR1413	520	BS75M NEW	527	BSDS9/16X12	516	BZL13/32	533	C512	535	C803	535
BR1414	521	BS80M NEW	527	BSDS9/16X6	516	BZL15/32	533	C5129	524	C806	535
BR1415	521	BS85M NEW	527	BSDSP1/2X12	516	BZL3/16	533	C513	535	C807	535
BR1416	520	BS9/32 NEW	526	BSDSP1/2X18	516	BZL3/8	533	C514	535	C808	535
BR1417	520	BS9/64 NEW	526	BSDSP1/2X6	516	BZL5/16	533	C515	535	C809	535
BR1418	520	BS90M NEW	527	BSDSP1/2X8	516	BZL5/32	533	C516	535	C810	535
BR1419	520	BS95M NEW	527	BSDSP1/4X12	516	BZL7/16	533	C517 NEW	535	C811	535
BR1420	520	BSB1/2	526	BSDSP1/4X4	516	BZL7/32	533	C523	535	C812	536
BR1421	520	BSB1/4	526	BSDSP1/4X6	516	BZL9/32	533	C524	535	C813	536
BR1422	521	BSB1/8	526	BSDSP1/4X8	516	BZR1	523	C527 NEW	537	C814	536
BR1423	520	BSB11/64	526	BSDSP3/4X12	516	BZR11/16	523	C528 NEW	537	C815	536
BR1424	520	BSB13/64	526	BSDSP3/4X18	516	BZR13/16	523	C529 NEW	537	C822	536
BR1425	521	BSB3/16	526	BSDSP3/4X8	516	BZR15/16	523	C532 NEW	537	C823	536
BR1426	520	BSB3/32	526	BSDSP3/8X12	516	BZR17/32	523	C533 NEW	537	C824 NEW	537
BR1427	521	BSB3/8	526	BSDSP3/8X4	516	BZR19/32	523	C536 NEW	537	C825 NEW	537
BS1/16 NEW	526	BSB5/16	526	BSDSP3/8X6	516	BZR21/32	523	C538 NEW	537	C826	537
BS1/2 NEW	526	BSB5/32	526	BSDSP3/8X8	516	BZR23/32	523	C539	539	C827	537
BS1/4 NEW	526	BSB5/8	526	BSDSP5/16X12	516	BZR25/32	523	C540	539	C828 NEW	537
BS1/8 NEW	526	BSB7/16	526	BSDSP5/16X6	516	BZR27/32	523	C541	539	C829 NEW	537
BS100M NEW	527	BSB7/32	526	BSDSP5/8X12	516	BZR29/32	523	C542	539	C832 NEW	537
BS105M NEW	527	BSB7/64	526	BSDSP5/8X6	516	BZR3/4	523	C543	539	C833	538
BS10M	527	BSB9/32	526	BSDSP5/8X8	516	BZR31/32	523	C544 NEW	539	C834	538
BS11/32 NEW	526	BSB9/64	526	BSDSP9/16X12	516	BZR33/64	523	C546 NEW	539	C835 NEW	538
BS11/64 NEW	526	BSD1-1/16 NEW	531	BSDSP9/16X6	516	BZR35/64	523	C547	539	C837 NEW	538
BS110M NEW	527	BSD1-1/2 NEW	531	BSR1 NEW	527	BZR37/64	523	C548	539	C839 NEW	538
BS115M NEW	527	BSD1-1/4 NEW	531	BSR3/4 NEW	527	BZR39/64	523	C549	539	C841 NEW	536
BS120M	527	BSD1-1/8 NEW	531	BSR5/8 NEW	527	BZR41/64	523	C562	539	C843 NEW	536
BS125M	527	BSD1-5/16 NEW	531	BSR7/8 NEW	527	BZR43/64	523	C563	539	C844 NEW	536
BS13/32 NEW	526	BSDS1/2X12	516	BSR9/16 NEW	527	BZR45/64	523	C564	539	C845 NEW	536
BS13/64 NEW	526	BSDS1/2X18	516	BT600	363	BZR47/64	523	C566 NEW	538	C846 NEW	536
BS130M	527	BSDS1/2X24	516	BT900	363	BZR49/64	523	C569 NEW	538	C847 NEW	536
BS15/32 NEW	526	BSDS1/2X6	516	BU45	309	BZR5/8	523	C572	536	C849 NEW	536
BS15/64 NEW	526	BSDS1/2X8	516	BU60	309	BZR51/64	523	C574	536	C850 NEW	537
BS15M NEW	527	BSDS1/4X12	516	BU75	309	BZR53/64	523	C575 NEW	536	C852 NEW	537
BS17/64 NEW	526	BSDS1/4X4	516	BU90	309	BZR55/64	523	C576	536	C854 NEW	539
BS19/64 NEW	526	BSDS1/4X6	516	BVS12 NEW	534	BZR57/64	523	C577 NEW	536	C855 NEW	539
BS20M NEW	527	BSDS1/4X8	516	BVS14 NEW	534	BZR59/64	523	C578	536	C856 NEW	539
BS21/64 NEW	526	BSDS1X12	516	BVS18 NEW	534	BZR61/64	523	C580	536	C857 NEW	539
BS23/64 NEW	526	BSDS1X18	516	BVS316 NEW	534	BZR63/64	523	C582 NEW	535	C859 NEW	539
BS25/64 NEW	526	BSDS3/16X4	516	BVS38 NEW	534	BZR7/8	523	C584 NEW	535	C860 NEW	539
BS25M NEW	527	BSDS3/16X6	516	BVS516 NEW	534	BZR9/16	523	C587 NEW	538	C861 NEW	539
BS27/64 NEW	526	BSDS3/16X8	516	BVU12 NEW	534	C1805	484	C588 NEW	538	C903	222
BS29/64 NEW	526	BSDS3/4X12	516	BVU14 NEW	534	C1806	484	C589 NEW	538	C903A	222
BS3/16 NEW	526	BSDS3/4X18	516	BVU18 NEW	534	C1808	484	C590 NEW	538	C904A	222
BS3/32 NEW	526	BSDS3/4X6	516	BVU316 NEW	534	C1810	484	C591 NEW	539	C905	222
BS3/8 NEW	526	BSDS3/4X8	516	BVU38 NEW	534	C1816	484	C593 NEW	539	C905B	222
BS30M NEW	527	BSDS3/8X12	516	BVU516 NEW	534	C23S30	665	C604	536	C906B	222
BS31/64 NEW	526	BSDS3/8X18	516	BZC1	533	C23S40	665	C605 NEW	536	C907	222
BS32M NEW	527	BSDS3/8X24	516	BZC1-1/2	533	C23S45	665	C606 NEW	535	C907A	222
BS35M NEW	527	BSDS3/8X6	516	BZC1-1/4	533	C23S50	665	C607 NEW	535	C908	222
BS40M NEW	527	BSDS3/8X8	516	BZC1-1/8	533	C23S65	665	C612 NEW	535	C908A	222
BS45M NEW	527	BSDS5/16X12	516	BZC1-11/16	533	C25L40	664	C613 NEW	535	C909	222

ITEM	PAGE	ITEM	PAGE	ITEM	PAGE	ITEM	PAGE	ITEM	PAGE	ITEM	PAGE
U C909A	222	S CASZ <small>NEW</small>	607	U CH104L	46	U CH125	57	U CH214-C	52	U CH304	50
U C910	222	S CAT602	588	U CH104L-C	46	U CH125-C	57	U CH214P <small>NEW</small>	59	U CH304-C	50
U C910A	222	S CAT604	588	U CH105	47	U CH126	55	U CH214P-C <small>NEW</small>	59	U CH304L	50
U C911	222	S CAT60S	588	U CH105-C	47	U CH126-C	55	U CH215	51	U CH304L-C	50
U C911A	222	S CAT60X	588	U CH106	46	U CH126L	55	U CH215-C	51	U CH305	51
U C912	222	S CAT804 <small>NEW</small>	588	U CH106-C	46	U CH126L-C	55	U CH216	51	U CH305L	50
U C920 <small>NEW</small>	535	S CAT80X <small>NEW</small>	588	U CH106L	46	U CH127	55	U CH216-C	51	U CH305L-C	50
U C921 <small>NEW</small>	535	S CATB	588	U CH106L-C	46	U CH127-C	55	U CH218	49	U CH306	50
U C926 <small>NEW</small>	535	S CAV45	574	U CH107	47	U CH127L	55	U CH218-C	49	U CH306L	50
U C927 <small>NEW</small>	535	S CAV48	574	U CH107-C	47	U CH127L-C	55	U CH219	49	U CH306L-C	50
U C928 <small>NEW</small>	535	S CAVF45 <small>NEW</small>	574	U CH107L	46	U CH128	53	U CH219-C	49	U CH307	54
U C929 <small>NEW</small>	535	S CAVF48 <small>NEW</small>	574	U CH107L-C	46	U CH128-C	53	U CH220	57	U CH307-C	54
U C936 <small>NEW</small>	536	S CAZ16	595	U CH108	47	U CH129	54	U CH220-C	57	U CH307L	53
U C937 <small>NEW</small>	536	S CAZ20	595	U CH108-C	47	U CH129-C	54	U CH221	57	U CH307L-C	53
U C942 <small>NEW</small>	536	S CAZ24	595	U CH108L	46	U CH130	56	U CH221-C	57	U CH308	56
U C943 <small>NEW</small>	536	S CAZ35	595	U CH108L-C	46	U CH130-C	56	U CH222	57	U CH308-C	56
U C944 <small>NEW</small>	538	S CC1	316	U CH109	48	U CH131	56	U CH222-C	57	U CH309	57
U C945 <small>NEW</small>	538	S CC2 <small>NEW</small>	316	U CH109-C	48	U CH131-C	56	U CH223	58	U CH309-C	57
U C946 <small>NEW</small>	538	S CC3 <small>NEW</small>	316	U CH110	48	U CH132	58	U CH223-C	58	U CH310	48
U C947 <small>NEW</small>	538	S CC4	316	U CH110-C	48	U CH132-C	58	U CH231P <small>NEW</small>	59	U CH310-C	48
U C948 <small>NEW</small>	538	S CC5	316	U CH110L	47	U CH151P <small>NEW</small>	61	U CH231P-C <small>NEW</small>	59	U CH310L	47
U C949 <small>NEW</small>	538	S CCL0D	686	U CH110L-C	47	U CH151P-C <small>NEW</small>	61	U CH232P <small>NEW</small>	59	U CH310L-C	47
U C952 <small>NEW</small>	537	S CCL0P	686	U CH111	49	U CH171P <small>NEW</small>	61	U CH232P-C <small>NEW</small>	59	U CH311	48
U C953 <small>NEW</small>	537	S CCL0RT2	686	U CH111-C	49	U CH171P-C <small>NEW</small>	61	U CH241P <small>NEW</small>	60	U CH311-C	48
U C954 <small>NEW</small>	537	S CCL0RT4	686	U CH111L	49	U CH172P <small>NEW</small>	62	U CH241P-C <small>NEW</small>	60	U CH311L	47
U C958 <small>NEW</small>	539	S CCL0S	686	U CH111L-C	49	U CH172P-C <small>NEW</small>	62	U CH242P <small>NEW</small>	60	U CH311L-C	47
U C959 <small>NEW</small>	539	U CD13	378	U CH111P <small>NEW</small>	59	U CH181P <small>NEW</small>	62	U CH242P-C <small>NEW</small>	60	U CH312	52
U C960 <small>NEW</small>	538	S CDG12	637	U CH111P-C <small>NEW</small>	59	U CH181P-C <small>NEW</small>	62	U CH251P <small>NEW</small>	60	U CH312-C	52
U C961 <small>NEW</small>	540	S CDG25	637	U CH112	53	U CH201	46	U CH251P-C <small>NEW</small>	60	U CH312L	52
U C962 <small>NEW</small>	540	S CDCT12	637	U CH112-C	53	U CH201-C	46	U CH252P <small>NEW</small>	60	U CH312L-C	52
U C964 <small>NEW</small>	540	S CDCT25	637	U CH113	53	U CH201L	45	U CH252P-C <small>NEW</small>	60	U CH313	52
S CA112	446	S CD120 <small>NEW</small>	655	U CH113-C	53	U CH201L-C	45	U CH253P <small>NEW</small>	60	U CH313-C	52
S CA113	446	S CD130 <small>NEW</small>	655	U CH114	49	U CH202	46	U CH253P-C <small>NEW</small>	60	U CH313L	52
S CA114	446	U CE1	380	U CH114L	49	U CH202-C	46	U CH254P <small>NEW</small>	60	U CH313L-C	52
S CA116	446	U CE2	380	U CH114L-C	49	U CH202L	45	U CH254P-C <small>NEW</small>	60	U CH314	51
S CA118	446	U CE3	380	U CH115	54	U CH202L-C	45	U CH255P <small>NEW</small>	60	U CH314-C	51
S CA122	446	S CEG32	483	U CH115-C	54	U CH203	48	U CH255P-C <small>NEW</small>	60	U CH315	58
S CA123	446	S CFG9	589	U CH115L	53	U CH203-C	48	U CH256P <small>NEW</small>	60	U CH315-C	58
S CA124	446	S CFP10	589	U CH115L-C	53	U CH203L	47	U CH256P-C <small>NEW</small>	60	U CH316	51
S CA132	446	S CFP11	589	U CH116	54	U CH203L-C	47	U CH271P <small>NEW</small>	61	U CH316-C	51
S CA134	446	S CFP6	589	U CH116-C	54	U CH206	48	U CH271P-C <small>NEW</small>	61	U CIA01 <small>NEW</small>	639
U CA18U <small>NEW</small>	475	S CFP9	589	U CH117	54	U CH206-C	48	U CH272P <small>NEW</small>	61	U CIAL01 <small>NEW</small>	637
S CAB1	320	S CG110 <small>NEW</small>	311	U CH117-C	54	U CH207	48	U CH272P-C <small>NEW</small>	61	U CIAL02 <small>NEW</small>	637
S CAB10	318	S CG112 <small>NEW</small>	311	U CH118	54	U CH207-C	48	U CH273P <small>NEW</small>	61	U CID01 <small>NEW</small>	637
S CAB29	592	S CG18 <small>NEW</small>	311	U CH118-C	54	U CH210	54	U CH273P-C <small>NEW</small>	61	U CID02 <small>NEW</small>	637
U CAB2UH	320	S CG3410 <small>NEW</small>	311	U CH118L	53	U CH210-C	54	U CH274P <small>NEW</small>	61	U CIE01	638
S CAB3	320	S CG3412 <small>NEW</small>	311	U CH118L-C	53	U CH210L	53	U CH274P-C <small>NEW</small>	61	U CIE02	638
S CAB36	569	S CG348 <small>NEW</small>	311	U CH119	55	U CH210L-C	53	U CH275P <small>NEW</small>	61	U CIM01	602
S CAB4	320	S CG7810 <small>NEW</small>	311	U CH119-C	55	U CH211	56	U CH275P-C <small>NEW</small>	61	U CIM02	602
S CAB43	600	S CG7812 <small>NEW</small>	311	U CH119L	54	U CH211-C	56	U CH276P <small>NEW</small>	61	U CIM03	602
S CAB55	602	S CG788 <small>NEW</small>	311	U CH119L-C	54	U CH211L	56	U CH276P-C <small>NEW</small>	61	U CIM06 <small>NEW</small>	602 p. 639
S CAB56	602	U CGREF1	82	U CH120	55	U CH211L-C	56	U CH281P <small>NEW</small>	62	S CL20	434
S CAB6	593	U CGREF2	82	U CH120-C	55	U CH211P <small>NEW</small>	59	U CH281P-C <small>NEW</small>	62	S CL30	434
U CAB6U	320	U CGREF3	82	U CH120L	55	U CH211P-C <small>NEW</small>	59	U CH282P <small>NEW</small>	62	S CL50 <small>NEW</small>	434
S CAB7	318	U CGREF4	82	U CH120L-C	55	U CH212	55	U CH282P-C <small>NEW</small>	62	U CLF30	435
U CAI25 <small>NEW</small>	474	U CGREF5	82	U CH121	57	U CH212-C	55	U CH283P <small>NEW</small>	62	U CLF50	435
S CANA100 <small>NEW</small>	700	U CGREF6	82	U CH121-C	57	U CH212L	55	U CH283P-C <small>NEW</small>	62	S CLFV20	435
S CANA101	700	U CH101	45	U CH122	57	U CH212L-C	55	U CH301	49	S CLFV30	435
S CASA <small>NEW</small>	607	U CH101-C	45	U CH122-C	57	U CH212P <small>NEW</small>	59	U CH301-C	49	S CLFV50	435
S CASB <small>NEW</small>	607	U CH102	45	U CH122L	56	U CH212P-C <small>NEW</small>	59	U CH302	49	U CLFX30	435
S CASN <small>NEW</small>	607	U CH102-C	45	U CH122L-C	56	U CH213	52	U CH302-C	49	U CLFX50	435
S CASO70	657	U CH103	45	U CH123	56	U CH213-C	52	U CH303	51	U CLL36	655
S CASOD	670	U CH103-C	45	U CH123-C	56	U CH213P <small>NEW</small>	59	U CH303-C	51	U CLL60	655
S CASR <small>NEW</small>	607	U CH104	46	U CH124	57	U CH213P-C <small>NEW</small>	59	U CH303L	50	U CLLC5 <small>NEW</small>	655
S CASV <small>NEW</small>	607	U CH104-C	46	U CH124-C	57	U CH214	52	U CH303L-C	50	S CLX100	435

ITEM	PAGE	ITEM	PAGE	ITEM	PAGE	ITEM	PAGE	ITEM	PAGE	ITEM	PAGE	ITEM	PAGE
CLX30	435	CPS17K <small>NEW</small>	70	CUTU4N	547	D3	66	D405G	241	DBS1 <small>NEW</small>	456		
CLX50	435	CPS19NP <small>NEW</small>	71	CV41	544	D300	246	D406 <small>NEW</small>	242	DBS200 <small>NEW</small>	456		
CM16 <small>NEW</small>	66	CPS19NT <small>NEW</small>	71	CV412	544	D302 <small>NEW</small>	240	D408 <small>NEW</small>	242	DBS300 <small>NEW</small>	456		
CM16G <small>NEW</small>	66	CPS19P <small>NEW</small>	71	CV414	544	D304	240	D409 <small>NEW</small>	242	DBS400 <small>NEW</small>	456		
CM20 <small>NEW</small>	66	CPS19T1 <small>NEW</small>	71	CV418	544	D305 <small>NEW</small>	240	D40DC <small>NEW</small>	242	DBS400A <small>NEW</small>	456		
CM20G <small>NEW</small>	66	CPS20	70	CV4316	544	D306 <small>NEW</small>	240	D414V	331	DBS400R <small>NEW</small>	456		
CM24 <small>NEW</small>	66	CPS20E	70	CV434	544	D308 <small>NEW</small>	240	D415V	331	DCA14	431		
CM24G <small>NEW</small>	66	CPS26 <small>NEW</small>	70	CV438	544	D309 <small>NEW</small>	240	D416 <small>NEW</small>	242	DCA19	431		
CM2G <small>NEW</small>	66	CPS2C	70	CV4516	544	D316 <small>NEW</small>	240	D416G	241	DCC007P <small>NEW</small>	240		
CM3G <small>NEW</small>	66	CPS6C <small>NEW</small>	70	CV458	544	D320 <small>NEW</small>	240	D416V	331	DCU1	638		
CMA1	64	CPS9	68	CV4716	544	D321 <small>NEW</small>	240	D420 <small>NEW</small>	242	DE640 <small>NEW</small>	342		
CMA2	64	CPSC20	70	CV478	544	D322 <small>NEW</small>	240	D421 <small>NEW</small>	242	DES3	447		
CMA3	64	CPSC20E <small>NEW</small>	70	CVD12	544	D324 <small>NEW</small>	240	D422 <small>NEW</small>	242	DES4	447		
CMA4	64	CPU17	69	CVD14	544	D325 <small>NEW</small>	240	D424 <small>NEW</small>	242	DES5	447		
CN650	483	CPU17A	69	CVD316	544	D327 <small>NEW</small>	240	D425 <small>NEW</small>	242	DES7	447		
CN963	483	CPU17AR	69	CVD38	544	D330	240	D4310 <small>NEW</small>	242	DES9	447		
CO5115	525	CPU19P <small>NEW</small>	71	CVD516	544	D332 <small>NEW</small>	240	D4315 <small>NEW</small>	242	DG2C <small>NEW</small>	456		
CO5121	525	CPU19T <small>NEW</small>	71	CVD58	544	D334	240	D432 <small>NEW</small>	242	DGN2C <small>NEW</small>	456		
CO5129	525	CPU20	69	CVD716	544	D335 <small>NEW</small>	240	D4320 <small>NEW</small>	242	D1100 <small>NEW</small>	436		
COA1 <small>NEW</small>	545	CPU20A	69	CVR58	544	D336 <small>NEW</small>	240	D4325 <small>NEW</small>	242	D140 <small>NEW</small>	436		
COA1116 <small>NEW</small>	545	CPU20AR <small>NEW</small>	69	CVR78	544	D340 <small>NEW</small>	240	D4327 <small>NEW</small>	242	DJY01	247		
COA114 <small>NEW</small>	545	CPU26A	69	CZ16 <small>NEW</small>	595	D341 <small>NEW</small>	240	D4330 <small>NEW</small>	242	DJY03	247		
COA118 <small>NEW</small>	545	CPU26AR	69	CZ20 <small>NEW</small>	595	D342 <small>NEW</small>	240	D434 <small>NEW</small>	242	DJY04	247		
COA12 <small>NEW</small>	545	CPUC20	69	CZ23 <small>NEW</small>	595	D343 <small>NEW</small>	240	D440 <small>NEW</small>	242	DMP4 <small>NEW</small>	342		
COA1516 <small>NEW</small>	545	CPUC20R <small>NEW</small>	69	CZ26 <small>NEW</small>	595	D344 <small>NEW</small>	240	D441 <small>NEW</small>	242	DPC02	431		
COA158 <small>NEW</small>	545	CR175 <small>NEW</small>	484	D01P <small>NEW</small>	240	D345	240	D442 <small>NEW</small>	242	DRN200 <small>NEW</small>	456		
COA2 <small>NEW</small>	545	CR200 <small>NEW</small>	484	D01PC <small>NEW</small>	240	D346 <small>NEW</small>	240	D443 <small>NEW</small>	242	DRS1 <small>NEW</small>	456		
COA34 <small>NEW</small>	545	CR250 <small>NEW</small>	484	D02P <small>NEW</small>	240	D347 <small>NEW</small>	240	D443G	241	DRS200 <small>NEW</small>	456		
COA58 <small>NEW</small>	545	CS60	588	D1	66	D348 <small>NEW</small>	240	D445 <small>NEW</small>	242	DRS300 <small>NEW</small>	456		
COA78 <small>NEW</small>	545	CSE01	640	D10	243	D349 <small>NEW</small>	240	D445G	241	DRS400 <small>NEW</small>	456		
COA916 <small>NEW</small>	545	CSE02	640	D2	66	D350	240	D446 <small>NEW</small>	242	DRT12	347		
COP14	282	CSE03	640	D200A <small>NEW</small>	235	D3500S <small>NEW</small>	241	D447 <small>NEW</small>	242	DT16 <small>NEW</small>	347		
COP18	282	CSE04	640	D200B <small>NEW</small>	235	D3506	241	D448 <small>NEW</small>	242	DTAL <small>NEW</small>	700		
COP18T	282	CSS01	605	D200C <small>NEW</small>	235	D3508	241	D449 <small>NEW</small>	242	DTH12	347		
COP24	282	CSS02	605	D202	235	D351 <small>NEW</small>	240	D4508 <small>NEW</small>	243	DVM	703		
COP24P	282	CTBASTM	588	D204	235	D3510	241	D451 <small>NEW</small>	242	E451	402		
COP30	282	CTLR	588	D205	235	D3512	241	D4510 <small>NEW</small>	243	ECA10 <small>NEW</small>	373		
COP36	282	CTM30	454	D206	235	D3514	241	D4512 <small>NEW</small>	243	ECA4	373		
CPA6A <small>NEW</small>	395	CTM55	454	D208	235	D3516	241	D4514 <small>NEW</small>	243	EEFV224	641		
CPF1-10S-US32D <small>NEW</small>	674	CU2G <small>NEW</small>	73	D20AC <small>NEW</small>	235	D352 <small>NEW</small>	240	D4516 <small>NEW</small>	243	EES1 <small>NEW</small>	641		
CPF1-10-US32DV <small>NEW</small>	674	CUAD100 <small>NEW</small>	696	D216	235	D353 <small>NEW</small>	240	D451G	241	EES112 <small>NEW</small>	641		
CPF1-5360-US32D <small>NEW</small>	673	CUAD20 <small>NEW</small>	696	D220	235	D354 <small>NEW</small>	240	D452 <small>NEW</small>	242	EES2 <small>NEW</small>	641		
CPF1-5362-US32D <small>NEW</small>	673	CUEP10	453	D222	235	D363 <small>NEW</small>	240	D454G	241	EES238 <small>NEW</small>	641		
CPF2-5362-US32D <small>NEW</small>	673	CUEP13	453	D224	235	D364	240	D464 <small>NEW</small>	242	EES318 <small>NEW</small>	641		
CPF3-1060-US32D <small>NEW</small>	674	CUEP4	453	D230	235	D365 <small>NEW</small>	240	D465 <small>NEW</small>	242	E1018 <small>NEW</small>	475		
CPF3-10S-US32D <small>NEW</small>	674	CUEP6	453	D232	235	D366 <small>NEW</small>	240	D466 <small>NEW</small>	242	E1820 <small>NEW</small>	476		
CPF3-5362-US32D <small>NEW</small>	673	CUEP8	453	D234	235	D367 <small>NEW</small>	240	D467 <small>NEW</small>	242	EIT01	400		
CPF3-5362-US32DV <small>NEW</small>	673	CUG9	589	D235	235	D368 <small>NEW</small>	240	D468 <small>NEW</small>	242	EIT02	400		
CP110	65	CUP10	589	D240	235	D369 <small>NEW</small>	240	D469 <small>NEW</small>	242	EIT03	400		
CP116	65	CUP11	589	D241	235	D371	240	D471 <small>NEW</small>	242	EIT04	400		
CP120	65	CUP6	589	D242	235	D381 <small>NEW</small>	240	D4C20	65	EMB1	419		
CP124R	65	CUP7	589	D243	235	D3C20	65	D4V <small>NEW</small>	331	EMB2	419		
CP19	65	CUP8	589	D244	235	D4	66	D4VC <small>NEW</small>	331	EMSC	90 y 294		
CPL30 <small>NEW</small>	454	CUP9	589	D245	235	D400A <small>NEW</small>	242	D5	66	EMSG	90		
CPM12	67	CUS26 <small>NEW</small>	696	D246	235	D400B <small>NEW</small>	242	D6	66	EMUC	90		
CPM16	67	CUTA1	546	D247	235	D400C <small>NEW</small>	242	D61	69	EMUG	90		
CPM7	67	CUTF13	549	D248	235	D400D <small>NEW</small>	242	D6C20	65	ENG50A <small>NEW</small>	485		
CP018	68	CUTF14	549	D249	235	D400G <small>NEW</small>	241	D7	66	EN916	485		
CP021	68	CUTF25	547	D251	235	D401V	331	D71	69	EN938	485		
CP025	68	CUTF7	549	D252	235	D402 <small>NEW</small>	242	D7C20	65	EN950	485		
CPOR10	68	CUTF8	548	D254	235	D402V	331	D8	66	ENCAB	703		
CPOR21	68	CUTF9	548	D264	235	D403G	241	D8C20	65	ENGON	703		
CPOR23	68	CUTU1	548	D266	235	D404 <small>NEW</small>	242	D9C20	65	EP211	458		
CPR27	67	CUTU3	548	D269	235	D404G	241	DB1401E	701	EP212	458		
CPS17	70	CUTU4	547	D271	235	D405 <small>NEW</small>	242	DB1402	405	EP213	458		

# 28 NUMERICAL INDEX

ITEM	PAGE	ITEM	PAGE	ITEM	PAGE	ITEM	PAGE	ITEM	PAGE	ITEM	PAGE
u EP214	458	S F4400 <small>NEW</small>	100	S F5116	118	S F5800T	135	S F5834	129	S F5948	139
u EP215	458	S F4400M <small>NEW</small>	100	S F5116HL	120	S F5800TL	135	S F5834HLM	133	S F5949	149
u EP216	458	S F4406HLM	115	S F5116HLM	121	S F5801T	135	S F5834L	132	S F5950	139
u EP2210	458	S F4407HLM	115	S F5116HM <small>NEW</small>	119	S F5809M	131	S F5836	129	S F5952	139
u EP222	458	S F4408HL	114	S F5116M	119	S F5810	129	S F5836HLM	133	S F5953	143
u EP223	458	S F4408HLM	115	S F5117HLM	121	S F5810HLM	133	S F5836L	132	S F5954	139
u EP224	458	S F4409HL	114	S F5117HM <small>NEW</small>	119	S F5810M	131	S F5838	129	S F5956	139
u EP225	458	S F4409HLM	115	S F5117M	119	S F5811HLM	133	S F5840	129	S F5958	139
u EP226	458	S F4410HL	114	S F5118	118	S F5811M	131	S F5849	149	S F5959	144
u EP228	458	S F4410HLM	115	S F5118HL	120	S F5812	129	S F5849RK	154	S F5960	139
u EP2310	458	S F4411HL	114	S F5118HLM	121	S F5812HL	132	S F5849XRK	154	S F5961	144
u EP232	458	S F4411HLM	115	S F5118M	119	S F5812M	131	S F5850	152	S F5963	144
u EP233	458	S F4412HL	114	S F5119HLM	121	S F5813HLM	133	S F5850X <small>NEW</small>	148	S F5964	139
u EP234	458	S F4412HLM	115	S F5119HM <small>NEW</small>	119	S F5813M	131	S F5851	152	S F5968	146
u EP236	458	S F4413HLM	115	S F5119M	119	S F5814	129	S F5852A	151	S F5985	143
u EP238	458	S F4414HL	114	S F5120	118	S F5814HL	132	S F5853	143	S F5986	146
u EP2410	458	S F4414HLM	115	S F512050	387	S F5814M	131	S F5854	143	u F9984	397
u EP242	458	S F4416HL	114	S F5120HL	120	S F5815HLM	133	S F5860	144	S FF-1	553
u EP243	458	S F4418HL	114	S F5120M	119	S F5815M	131	S F5861	144	S FF-1 1/2	553
u EP244	458	S F4449	149	S F5121M	119	S F5816	129	S F5863	144	S FF-1 1/4	553
u EP245	458	S F4449RK	154	S F5122	118	S F5816HLM	133	S F5867	146	S FF-1/2	553
u EP246	458	S F4449XRK	154	S F5122HL	120	S F5816L	132	S F5868	146	S FF-1/4	553
u EP247	458	S F4450	152	S F5122M	119	S F5816M	131	S F5885	143	S FF-3/4	553
u EP248	458	S F4450X <small>NEW</small>	148	S F5124	118	S F5817	129	S F5886	146	S FF-3/8	553
u EP249	458	S F4451E	99	S F5124HL	120	S F5817HLM	133	S F58C <small>NEW</small>	105	S FF-5/8	553
u EP4410	458	S F4451T	98	S F5126	118	S F5817M	131	S F58H01	135	S FF-7/8	553
u EP444	458	S F4452A	151	S F5126HL	120	S F5818	129	S F58H01M	136	u FIJPA <small>NEW</small>	689
u EP445	458	S F4456	143	S F5126HPA	387	S F5818HLM	133	S F58H06M	136	u FIJPL <small>NEW</small>	689
u EP446	458	S F4458	35	S F5128	118	S F5818L	132	S F58H08	135	u FIJPS <small>NEW</small>	689
u EP448	458	S F4458A	35	S F5128HL	120	S F5818M	131	S F58H08M	136	u FLXAV3 <small>NEW</small>	436
S EQC10	373	S F4458AM	35	S F5130	118	S F5819	129	S F58H10	135	u FLXAV5 <small>NEW</small>	436
S EQC20 <small>NEW</small>	373	S F4458M	35	S F5132	118	S F5819HLM	133	S F58H10M	136	u FLXAV8 <small>NEW</small>	436
S EQC4	373	S F4460	144	S F5149	149	S F5819M	131	S F58H12	135	S FMO12 <small>NEW</small>	576
u ER11	457	S F4461	144	S F5149RK	154	S F581S <small>NEW</small>	107	S F58H12M	136	S FMO16 <small>NEW</small>	576
u ER116	457	S F4469	144	S F5149XRK	154	S F5820	129	S F58H14	135	S FMO20 <small>NEW</small>	576
u ER118	457	S F4485	143	S F5150	152	S F582050	387	S F58H14M	136	u F01 <small>NEW</small>	553
u ER12	457	S F5100T	124	S F5150X <small>NEW</small>	148	S F5820L	132	S F58H16	135	u F0112 <small>NEW</small>	553
u ER13	457	S F5101C	102	S F5153	143	S F5820M	131	S F58H17M	136	u F0114 <small>NEW</small>	553
u ER21	457	S F5107M	119	S F5155	143	S F5821M	131	S F58H18	135	u F012 <small>NEW</small>	553
u ER22	457	S F5108	118	S F5160	144	S F5822	129	S F58H20	135	u F014 <small>NEW</small>	553
u ER23	457	S F5108M	119	S F5161	144	S F5822L	132	S F58M <small>NEW</small>	109	u F02 <small>NEW</small>	553
u ER33	457	S F5109M	119	S F5165	146	S F5822M	131	S F58S <small>NEW</small>	107	u F034 <small>NEW</small>	553
u ER34	457	S F5110	118	S F5185	143	S F5823M	131	S F58T20	135	u F038 <small>NEW</small>	553
u ER35	457	S F5110HLM	121	S F51H00	124	S F5824	129	S F58T25	135	u F058 <small>NEW</small>	553
u ER36	457	S F5110HM <small>NEW</small>	119	S F51H00M	125	S F5824L	132	S F58T30	135	u FRM	703
u ER63	457	S F5110M	119	S F51H04M	125	S F5824M	131	S F58T40	135	S FU10 <small>NEW</small>	576
u ER64	457	S F5111HLM	121	S F51H05M	125	S F5825	129	S F58T45	135	S FU3 <small>NEW</small>	576
u ER66	457	S F5111HM <small>NEW</small>	119	S F51H06	124	S F5825M	131	S F58T50	135	S FU5 <small>NEW</small>	576
u ER74	457	S F5111M	119	S F51H06M	125	S F5826	129	S F58T55	135	S FU8 <small>NEW</small>	576
u ER76	457	S F5112	118	S F51H07	124	S F5826HPA	387	S F5924	139	u G1610	486
u ER78	457	S F5112HL	120	S F51H07M	125	S F5826L	132	S F5926	139	u G1612	486
u ER95	457	S F5112HLM	121	S F51H08	124	S F5826M	131	S F5928	139	u G1804	486
u ER97	457	S F5112HM <small>NEW</small>	119	S F51H08M	125	S F5827M	131	S F5930	139	u G1805	486
u ESP22F <small>NEW</small>	566	S F5112M	119	S F51H10	124	S F5828	129	S F5932	139	u G1806	486
u ESP26F <small>NEW</small>	566	S F5113HLM	121	S F51H10M	125	S F5828L	132	S F5934	139	u G1808	486
S ETFV25	641	S F5113HM <small>NEW</small>	119	S F51H12	124	S F5828M	131	S F5936	139	u G1810	486
S ETFV27	641	S F5113M	119	S F5800	107	S F5829M	131	S F5938	139	u G1812	486
u EX27M5	80	S F5114	118	S F5800A <small>NEW</small>	129	S F5830	129	S F5938HL	141	u G2202	486
u EX27M6	80	S F5114HL	120	S F5800AM	131	S F5830HLM	133	S F5940	139	u G2205	486
u EX27S6	80	S F5114HLM	121	S F5800B	107	S F5830L	132	S F5940HL	141	u G5115	529
u EXA2	359	S F5114HM <small>NEW</small>	119	S F5800BM	109	S F5830M	131	S F5942	139	u G5121	529
u EXA5	359	S F5114M	119	S F5800C	107	S F5832	129	S F5942HL	141	u G5129	529
u EXA7	359	S F5115HLM	121	S F5800CM	109	S F5832HLM	133	S F5944	139	S GALA	628
S F09S <small>NEW</small>	107	S F5115HM <small>NEW</small>	119	S F5800HL	132	S F5832L	132	S F5946	139	S GALN	627
S F108P <small>NEW</small>	696	S F5115M	119	S F5800M	109	S F5832M	131	S F5946HL	141	S GALNS <small>NEW</small>	627



ITEM	PAGE	ITEM	PAGE	ITEM	PAGE	ITEM	PAGE	ITEM	PAGE	ITEM	PAGE	ITEM	PAGE
GAN01	448	GCAE	626	GS3C <small>NEW</small>	89	HSA76	543	JCM2S <small>NEW</small>	38	JPX4 <small>NEW</small>	604	JCM2S	38
GAN02	448	GCAL	626	GS3G <small>NEW</small>	90	HT21	455	JCM3S <small>NEW</small>	38	JR6 <small>NEW</small>	604	JCM3S	38
GAN03	448	GCH3	449	H27I2	86	I24C10	87	JCM4S <small>NEW</small>	38	JR7 <small>NEW</small>	604	JCM4S	38
GAN04	448	GCH4	449	H27M4	85	I24C4	88	JCO3 <small>NEW</small>	439	JR8 <small>NEW</small>	604	JCO3	439
GAN05	448	GCH5	449	H27M6	85	I27M3	87	JDB13	234	JRASP4	323	JDB13	234
GAN06	448	GCH6	449	H27M7S	82	I27M5	87	JDB36	234	JSB306	78	JDB36	234
GAN07	448	GCH7	449	H27S6	86	I27S4	87	JDB6V	330	JSB307	78	JDB6V	330
GANCC1	448	GG813 <small>NEW</small>	478	H27S7S	82	I27S6	87	JDB7	234	JSB36	64	JDB7	234
GANCC2	448	GG835A <small>NEW</small>	478	H27W3	85	I59W	74	JDPUI17	247	JSB48	64	JDPUI17	247
GANCC3	448	GG870 <small>NEW</small>	478	H35W7	85	I59W2	74	JDT12	231	JSB60	64	JDT12	231
GANCC4	448	GG890 <small>NEW</small>	478	H41M12	84	IN27M3 <small>NEW</small>	88	JDT25	230	JUP18	265	JDT25	230
GANCC5	448	GJ15	598	H41S8	86	IN27M5 <small>NEW</small>	88	JDT5	231	JUP34	264	JDT5	231
GANS3	448	GJ30	598	H5113	522	IN27M6 <small>NEW</small>	88	JDT8	231	JUP42	264	JDT8	231
GANS4	448	GJ60	598	H5115	522	J200G	287	JE11	32	JUP42A	264	JE11	32
GANS5	448	GLFC <small>NEW</small>	628	H5118MC	522	J201G	295	JE23V <small>NEW</small>	326	JUP48	263	JE23V	326
GAT3	452	GLFG <small>NEW</small>	628	H5121	522	J230	273	JE23VM <small>NEW</small>	326	JUP54	263	JE23VM	326
GAT5	452	GLFM <small>NEW</small>	628	H5129	522	J2315	273	JE6 <small>NEW</small>	32 y 284	L044CSB	691	JE6	32
GAT5M	452	GLG <small>NEW</small>	628	HB1218B	563	J2415	273	JE6A	32	L044LAB	691	JE6A	32
GAT7	452	GLM <small>NEW</small>	628	HB1224B	563	J2415M	273	JEL11	426	L044LBB	691	JEL11	426
GAT7M	452	GLPG <small>NEW</small>	628	HC 1 1/2	570	J2CC	667	JEL3	427	L048CSB	691	JEL3	427
GAT9	452	GLPM <small>NEW</small>	628	HC 1 1/4	570	J2CCL	667	JEL9	426	L048LAB	691	JEL9	426
GAT9M	452	GM3G <small>NEW</small>	90	HC1 1/2F <small>NEW</small>	569	J3F <small>NEW</small>	553	JEX11 <small>NEW</small>	552	L048LBB	691	JEX11	552
GAVA1 <small>NEW</small>	72	GM6G <small>NEW</small>	90	HD28M4	83	J4330	357	JF03	553	L18S25EB <small>NEW</small>	660	JF03	553
GAVA2 <small>NEW</small>	72	GMU10	74	HD28M6	83	J4CIL	664	JGP4	323	L18S30EB <small>NEW</small>	660	JGP4	323
GAVA3 <small>NEW</small>	72	GMU13	74	HD28S4	83	J4CL	661	JGT01	96	L18S40EB <small>NEW</small>	660	JGT01	96
GAVA4 <small>NEW</small>	72	GMU18	74	HD35M8	83	J4CLA	665	JHS12	542	L18S50EB <small>NEW</small>	660	JHS12	542
GAVG1 <small>NEW</small>	72	GNIJ <small>NEW</small>	628	HD38M8	83	J6011	273	JHS8	542	L200AL	685	JHS8	542
GAVG2 <small>NEW</small>	72	GNNC	627	HDAC1	83	J607	278	JHT7	228	L20C75EB	668	JHT7	228
GAVG3 <small>NEW</small>	72	GNNG	627	HDAC2	83	J9700V	331	JJ112	44	L20L25EB	658	JJ112	44
GAVG4 <small>NEW</small>	72	GNNM	627	HDAC3	84	JA3 <small>NEW</small>	31 y 395	JJ194	44	L20L30EB	660	JA3	31
GAVN1 <small>NEW</small>	72	GNPC <small>NEW</small>	628	HDAC4	84	JAZ6 <small>NEW</small>	594	JJ50	44	L20L40EB	660	JAZ6	594
GAVN2 <small>NEW</small>	72	GNPG <small>NEW</small>	628	HDAC5	84	JAZ7S	594	JJLMC12M	204	L20L45EB	660	JAZ7S	594
GAVN3 <small>NEW</small>	72	GNPM <small>NEW</small>	628	HDAC6	84	JBAR	704	JJLMC12MR	205	L20L50EB	660	JBAR	704
GAVN4 <small>NEW</small>	72	GONC	702	HDREF1	84	JBARC <small>NEW</small>	704	JJLMC9	204	L20S20EB	658	JBARC	704
GAVPIN <small>NEW</small>	72	GONCA	702	HDREF2	84	JBAV10 <small>NEW</small>	526	JJLMC9R	205	L20S25EB	658	JBAV10	526
GAVR1 <small>NEW</small>	72	GONI <small>NEW</small>	702	HMS 1/2	570	JBAV13 <small>NEW</small>	526	JJM12S15 <small>NEW</small>	584	L20S30EB	660	JBAV13	526
GAVR2 <small>NEW</small>	72	GONP	702	HMFV3 1/2 <small>NEW</small>	569	JBAV17	526	JJM12ST15 <small>NEW</small>	586	L20S40BB	659	JBAV17	526
GAVR3 <small>NEW</small>	72	GONPA	702	HS1	542	JBAV21	526	JJM4	427	L20S40EB	660	JBAV21	526
GAVR4 <small>NEW</small>	72	GONS <small>NEW</small>	702	HS1-1/16	542	JBAV29	526	JJM6	427	L20S40QB	659	JBAV29	526
GAW1 <small>NEW</small>	72	GONU <small>NEW</small>	702	HS1-1/16	542	JBAV5 <small>NEW</small>	526	JJMC1/2-13	558	L20S40TB	659	JBAV5	526
GAW2 <small>NEW</small>	72	GOS01 <small>NEW</small>	611	HS1-1/2	542	JBAV7 <small>NEW</small>	526	JJMC1/4-20	558	L20S45EB	660	JBAV7	526
GAW3 <small>NEW</small>	72	GOSM1 <small>NEW</small>	698	HS1-1/4	542	JBAVN29	530	JJMC1/8-40	558	L20S50BB	659	JBAVN29	530
GAV4 <small>NEW</small>	72	GOUG <small>NEW</small>	698	HS1-1/8	542	JBE3 <small>NEW</small>	533	JJMC3/16-24	558	L20S50EB	660	JBE3	533
GAVZ1 <small>NEW</small>	72	GOUJA <small>NEW</small>	698	HS1-11/16	542	JBM3 <small>NEW</small>	533	JJMC3/4-10	558	L20S50QB	659	JBM3	533
GAVZ2 <small>NEW</small>	72	GOUTR <small>NEW</small>	698	HS1-3/16	542	JBM6 <small>NEW</small>	519	JJMC3/8-16	558	L20S50TB	659	JBM6	519
GAVZ3 <small>NEW</small>	72	GRAC10	634	HS1-3/4	542	JBP13	519	JJMC5/16-18	558	L20S60BB	659	JBP13	519
GAVZ4 <small>NEW</small>	72	GRAC12	634	HS1-3/8	542	JBP6	519	JJMC5/8-11	558	L20S60QB	659	JBP6	519
GBAR	704	GRAC16	634	HS1-5/8	542	JBREF1	64	JJMD5 <small>NEW</small>	432	L20S60TB	659	JBREF1	64
GBH20	405	GRAC5	634	HS1-7/16	542	JBU03	239	JJMHO1 <small>NEW</small>	37	L20X30EB	660	JBU03	239
GBLO	626	GRAC6	634	HS1-7/8	542	JBUA01M	109	JJMHO2 <small>NEW</small>	37	L20X40EB	660	JBUA01M	109
GBS12	406	GRAC8	634	HS1-9/16	542	JBUA01S	107	JJMHO5 <small>NEW</small>	32	L20X50EB	660	JBUA01S	107
GBS16	407	GRI1	449	HS2	542	JBUA02M	104	JJMP5 <small>NEW</small>	38 y 442	L21M20PT	666	JBUA02M	104
GBS2	405	GRI10	449	HS2-1/2	542	JBUA02S	103	JJPB6 <small>NEW</small>	604	L21M36	666	JBUA02S	103
GBS20	407	GRI11	449	HS2-1/4	542	JBUDD01	237	JJPB60	278	L220AL	685	JBUDD01	237
GBS32	407	GRI12	449	HS2-1/8	542	JBUD02	237	JPE5	427	L22A40DCSB	656	JBUD02	237
GBS4	406	GRI13	449	HS2-3/4	542	JBVS4 <small>NEW</small>	534	JJPG4 <small>NEW</small>	604	L22A50DCSB	656	JBVS4	534
GBS50	407	GRI14	449	HS2-3/8	542	JBVU4 <small>NEW</small>	534	JJPH04 <small>NEW</small>	41	L22A60DCSB	656	JBVU4	534
GBS6	406	GRI2	449	HS3	542	JCB01 <small>NEW</small>	35	JJPM4 <small>NEW</small>	604	L22A70DCSB	656	JCB01	35
GBS8	406	GRI3	449	HS3/4	542	JCB02 <small>NEW</small>	36	JJPRC4 <small>NEW</small>	604	L22C70ECSB	668	JCB02	36
GC3	449	GRI4	449	HS3-1/2	542	JCB03 <small>NEW</small>	36	JJPRG4 <small>NEW</small>	604	L22C70ELBB	668	JCB03	36
GC5	449	GRI5	449	HS3-3/4	542	JCD01	97	JJPS6 <small>NEW</small>	604	L22C70TCSB	668	JCD01	97
GC6	449	GRI6	449	HS5/8	542	JCDT13	230	JJT-1	354	L22C70TLBB	668	JCDT13	230
GC7	449	GRI7	449	HS7/8	542	JCM01	36	JJT-1/2	354	L22C80ECSB	668	JCM01	36
GC77 <small>NEW</small>	545	GRI8	449	HS9/16	542	JCM02	36	JJT-2	354	L22C80ELBB	668	JCM02	36
GC8	449	GRI9	449	HSA38	543	JCM1S <small>NEW</small>	37	JJT-3/4	354	L22C80QCBB	667	JCM1S	37

ITEM	PAGE	ITEM	PAGE	ITEM	PAGE	ITEM	PAGE	ITEM	PAGE	ITEM	PAGE
L22C80TCSB	668	L6803LB	694	LBA40LA	652	LEN50	642	LPC212NIB	693	M12S6	584
L22C80TLBB	668	L6804CS	694	LBA40LB	652	LEN80	642	LPC314LBB	693	M12T10	585
L22L382	661	L6804LB	694	LBA40NI	652	LENG2	370	LPC314NIB	693	M12T100	585
L22L38A	663	L6805CS	694	LBC20LA	652	LENG4	370	LPC412LBB	693	M12T10P	586
L22L38EACB	663	L6805LB	694	LBC20LB	652	LER120	642	LPC412NIB	693	M12T15	585
L22L40DCSB	662	L6806CS	694	LBC20NS	652	LER36	642	LPM100	692	M12T15P	586
L22L452	661	L6806LB	694	LBC25LA	652	LER50	642	LPM130	692	M12T20	585
L22L45A	663	L6807CS	694	LBC25LB	652	LER80	642	LPM145	692	M12T20P	586
L22L45EACB	663	L6807LB	694	LBC25NS	652	LETD	673	LPM85	692	M12T25	585
L22L50A	663	L6808CS	694	LBC30B	652	LF1000	381	LR000B	676	M12T6	585
L22L50DCSB	662	L6808LB	694	LBC30LA	652	LF1500	381	LR030B	676	M12TV50	585
L22L50EACB	663	L6809CS	694	LBC30LB	652	LF2000	381	LR062B	676	M1S100	583
L22L60DCSB	662	L6809LB	694	LBC30NS	652	LF2500	380	LR12X17	643	M1S50	583
L22L65EACB	657	L680N	694	LBC35LA	652	LF500	381	LR12X17A	643	M1T100	585
L22S32ELBB	663	L681N	694	LBC35LB	652	LF5000	381	LR12X17B	643	M1T50	585
L22S382	661	L682N	694	LBC35NS	652	LF6000	381	LR1X2	643	M3 1/2	570
L22S384	661	L683N	694	LBC40LA	652	LGP100A	690	LR1X2A	643	M34S100	583
L22S38A	663	L684N	694	LBC40LB	652	LGP100B	690	LR2X3	643	M34S25	584
L22S38EACB	663	L685N	694	LBC40NS	652	LGP100D	690	LR2X3A	643	M34T100	585
L22S38ELBB	663	L686N	694	LBD135E	654	LGP100N	690	LR2X3B	643	M34T25	585
L22S40DCSB	662	L687N	694	LBD165E	654	LGPA100A	690	LR3X3	643	M56M8	79
L22S452	661	L688N	694	LBD26C	654	LGPA100B	690	LR3X3A	643	M56S7	79
L22S45A	663	L689N	694	LBD26R	654	LGPA100D	690	LR3X3B	643	M58S100	583
L22S45EACB	663	L68N	694	LBD35AP	653	LGPA100N	690	LR3X4	643	M58T100	585
L22S50A	663	L69N	694	LBD35C	654	LI1018	475	LR3X4A	643	M58T15	585
L22S50DCSB	662	L701ACS	694	LBD35CP	653	LI1212	474	LR3X4B	643	M58T20	585
L22S50EACB	663	L701ALB	694	LBD35R	654	LI1213	474	LR3X5	643	M58T25	585
L22S50ELBB	663	L701BCS	694	LBD35RP	653	LI1219	474	LR3X6	643	MA534K	493
L22S60DCSB	662	L701BLB	694	LBDM	654	LI129	474	LR45120	642	MAR10	318
L22S63ELBB	663	L701CCS	694	LBP1	654	LI820	476	LR4X4	643	MAR10FV	317
L22S65EACB	657	L701CLB	694	LBP13	654	LJ1M12N	685	LR4X5	643	MAR12	318
P L24S30EB	665	L701DCS	694	LBP13H	654	LJM124	685	LR4X5A	643	MAR12FV	317
P L24S40EB	665	L701DLB	694	LBP1H	654	LJM124H	685	LR4X5B	643	MAR14	318
P L24S50EB	665	LAG100	642	LBP2	654	LJM156	685	LR4X6	643	MAR14FV	317
L26S50AMB	666	LAG1000	642	LBP23	654	LJM156H	685	LR4X6A	643	MAR16	318
L26S50NGB	666	LAG120	642	LBP23H	654	LJM188	685	LR4X6B	643	MAR16FV	317
L26S50RJB	666	LAG1200	642	LBP2H	654	LJM188H	685	LR5120	642	MAR2	318
P L5202AL	688	LAG150	642	LBP3	654	LJM220	685	LR5X5	643	MAR2FV	317
P L5203AL	688	LAG180	642	LBP33	654	LJM220H	685	LR5X6	643	MAR3	318
P L5501AL	684	LAG220	642	LBP33H	654	LJM252	685	LR5X6A	643	MAR3FV	317
L600C	694	LAG240	642	LBP3H	654	LJM252H	685	LR5X6B	643	MAR4	318
L601C	694	LAG280	642	LBT1	654	LJM316	685	LR5X7	643	MAR4FV	317
L602C	694	LAG320	642	LBT12	654	LJM444	685	LR6X12	643	MAR6	318
L603C	694	LAG360	642	LBT34	654	LJM501	685	LR6X12A	643	MAR6FV	317
L604C	694	LAG400	642	LBT38	654	LJM668	685	LR6X12B	643	MAR8	318
L605C	694	LAG500	642	LBT58	654	LLAV20	696	LR6X6	643	MAR8FV	317
L606C	694	LAG600	642	LCAC40	656	LLAV70	696	LR6X9	643	MARR3X	317
L607C	694	LAG80	642	LCAC50	656	LLAV80	696	LR7X10	643	MARR4X	317
L608C	694	LBA10LB	652	LCAC60	656	LLAVU1	696	M12C10	583	MAT01	354
L609C	694	LBA10NI	652	LCMUL	703	LLC14P	394	M12C100	582	MAT02	354
L60N	694	LBA15LA	652	LCP300	687	LLC18M	394	M12C15	583	MATB	463
L61N	694	LBA15LB	652	LCP500	687	LLC18MJ	394	M12C20	583	MBR	534
L62N	694	LBA15NI	652	LCV20	687	LLPA100	696	M12C25	583	MC1/2-13	558
L63N	694	LBA20LA	652	LE2.5	570	LMC100	642	M12C50	582	MC1/4-20	558
L64N	694	LBA20LB	652	LE2.5M	570	LMC120	642	M12C6	583	MC1/8-40	558
L65N	694	LBA20NI	652	LE3	570	LMC180	642	M12S10	584	MC1-8	558
L66N	694	LBA25LA	652	LE3.5	570	LMC80	642	M12S100	583	MC3/16-24	558
L67N	694	LBA25LB	652	LE3.5M	570	LMK100	642	M12S10P	584	MC3/4-10	558
L6800CS	694	LBA25NI	652	LE3M	570	LMK60	642	M12S15	584	MC3/8-16	558
L6800LB	694	LBA30LA	652	LE4	570	LN0512	492	M12S15P	584	MC5/16-18	558
L6801CS	694	LBA30LB	652	LE4M	570	LNR506	491	M12S20	584	MC5/8-11	558
L6801LB	694	LBA30NI	652	LECS	674	LNR606	491	M12S20P	584	MC7/16-14	558
L6802CS	694	LBA35LA	652	LEMD	673	LPC134LBB	693	M12S25	584	MC7/8-9	558
L6802LB	694	LBA35LB	652	LEN120	642	LPC134NIB	693	M12S25P	584	MC9/16-12	558
L6803CS	694	LBA35NI	652	LEN36	642	LPC212LBB	693	M12S50	583	MDHK	371

NUMERICAL INDEX

ITEM	PAGE	ITEM	PAGE	ITEM	PAGE	ITEM	PAGE	ITEM	PAGE	ITEM	PAGE
MEL10	461	P22L38	663	PASC8	691	PER5DF	450	PHE52	272	PORTU	698
MEL3	461	P22L382	662	PASL10	691	PER6	450	PHE5322	272	PP5M	593
ML3.5M	570	P22L38B	663	PASL12	691	PER7	450	PHE62	272	PPA1	509
ML3M	570	P22L45	663	PASL5	691	PER7A	450	PHE82	272	PPB1	509
ML4M	570	P22L452	662	PASL8	691	PER8	450	PHI30	411	PPB2	509
MMG92	644	P22L45B	663	PASN10	691	PER9	450	PHIP20	411	PPG1	508
MN612A	495	P22L50	663	PASN12	691	PER9A	450	PI412A	503	PPG10	507
MOCHS	698	P22L50B	663	PASN5	691	PEX147	279	PI612	503	PPG13	507
MOCU	698	P22S38	663	PASN8	691	PF38062-3000-32DLH	671	PLAS	697	PPG17	507
MP117	91	P22S382	662	PAVEC1	692	PF38062-3000-32DLHV	671	PLAU	697	PPG2	508
MP122	91	P22S384	662	PAVEC2	692	PF38062-3000-32DRH	671	PLC10	298	PPG3	508
MP215	91	P22S38B	663	PAVEN1	692	PF38062-3000-32DRHV	671	PLC6	298	PPG4	508
MP218	91	P22S45	663	PAVEN2	692	PF511	276	PLC8	298	PPH01A	269
MP23M4	79	P22S452	662	PB12	278	PF512	276	PLC9	298	PPH02	269
MP28M5	79	P22S45B	663	PB8	278	PF515	275	PLHV1	409	PPH03	269
MPE	91	P22S50	663	PC11	303	PF520	270	PLHV2	409	PPH11A	269
MPEP	91	P22S50B	663	PC18	303	PF521	270	PLM1	390	PPH11C	269
MPH	91	P6120A	506	PC6	303	PF522	270	PLML	697	PPH12	270
MPORT	703	P727	501	PC727A	497	PF523	268	PLMS	697	PPH12A	269
MPP15	586	P731B	503	PC731A	498	PF524	268	PLMS6	697	PPH12C	269
MT01	401	P731C	502	PC776A	500	PF525	266	PLMU	697	PPH13	269
MT02	401	P734HA	502	PC798	506	PFA02	611	PLUE2	410	PPH14	269
MT03	401	P772HB	505	PCA18	303	PF815	275	PME25	581	PPH21A	269
MT04	401	P776A	505	PCA38	267	PF84	275	PMM45	581	PPH21C	269
MTA414	496	P797-9	505	PCA516	267	PFC100	274	PMOR1	364	PPH22	270
MU58R100	582	P893B	500	PCA6	303	PFC20	275	PMOR3	364	PPH22A	269
MU58R25	582	P898-9	506	PCA716	267	PFC29	274	PMR45	581	PPH22C	269
MUL02	428	PA2	509	PCB11	302	PFC33	274	PMS20	581	PPH23	269
MUL03	428	PABA4	692	PCB6	302	PFC9	266	PNL4	303	PPH24	269
MUL04	429	PABA6	692	PCF35	352	PF09	274	PNLB6	302	PPH2PL	276
MY-660-US32D	677	PABA8	692	PCJ1/4	267	PF099	274	PNLB9	302	PPH31A	269
MY-CT5362BOLA-US5	679	PABL4	692	PCJ10	267	PF099	274	POEL01	463	PPH32	270
NELCV	333	PABL6	692	PCJ12	267	PF099	274	POEL03	463	PPH32A	269
NELV	333	PABL8	692	PCJ14	267	PF10	304	POEL07	463	PPH32B	269
NEX1	552	PABN4	692	PCJ3/8	267	PF12	304	POEL09	463	PPH33	269
NF10	550	PABN6	692	PCJ316	267	PF7	304	POEL11	463	PPL101	268
NF11	551	PABN8	692	PCJ5	267	PFR01	283	POLAC10A	465	PPL102	268
NF12	551	PABS4	692	PCJ5/16	267	PFR02	283	POLAC1A	465	PPL142	268
NF6	551	PABS6	692	PCJ6	267	PFR600	286	POLAC1A-6	465	PPL382	268
NF7	552	PABS8	692	PCJ8	267	PFR6090	286	POLAC1L	466	PPL5162	268
NF9	552	PAF3	380	PCU12	303	PFR610	286	POLAC2A	465	PPL62	268
NL1	443	PAF7	380	PCU4	303	PFR6190	286	POLAC2A-6	465	PPL82	268
NL12A	443	PALACL	590	PCUB5	302	PFT7	275	POLAC2L	466	PPL9322	268
NL2	443	PALAP	591	PCUB7	302	PFT9	275	POLAC3A	465	PPR1V	333
NL2A	443	PALCCL	590	PDP2932	276	PFTX9	275	POLAC3A-6	465	PPR2V	333
NL2E	443	PALCCP	592	PECO1	297	PGA2	451	POLAC3L	466	PPR21	277
NO.2	310	PALCM1	590	PECO2	297	PGA4	451	POLAC4A	465	PR12	303
NO.3	310	PALCP	591	PECO3	297	PGA8	451	POLAC4A-6	465	PR150	366
NO.4	310	PALCRP	592	PECO5	297	PGD05	451	POLAC4L	466	PR225	366
NO.46	309	PALEM1	590	PEL12	370	PGD10	451	POLAC5A	465	PR300	366
NO.5	310	PALEP	591	PEL58	370	PGD15	451	POLAC5A-6	465	PRC10	364
NO.6	309	PALICL	590	PEM1/4	280	PGR60NV	672	POLAC7A	465	PRC12	364
NO.8	310	PALIL	590	PER1	450	PGR62NV	672	POLEC1	464	PRC4	364
NO.9	310	PALRCL	590	PER10	450	PGS05	451	POLEC2	464	PRC5	364
P02	285	PALRCL	590	PER10A	450	PGS10	451	POLEC3	464	PRC6	364
P1098-9	505	PALRL	590	PER11	450	PGS15	451	POLEC4	464	PRC8	364
P1900	376	PALRM1	590	PER12	450	PHC4S	93	POLPAL1	467	PRES2	366
P1902	376	PALRP	591	PER1A	450	PHE142	272	POLPAL2	467	PRES4	366
P1904	376	PASA10	691	PER2	450	PHE182	272	POLPAL3	467	PRP12	365
P1908	376	PASA12	691	PER3	450	PHE22	272	POLPAL6	467	PRP24	365
P1910	376	PASA5	691	PER3A	450	PHE3162	272	POPA01	466	PRP6	365
P1914	376	PASA8	691	PER3DF	450	PHE32	272	POPA02	466	PSF3	599
P1921	376	PASC10	691	PER4	450	PHE3322	272	POPA03	466	PSF35	599
P19C70	669	PASC12	691	PER5	450	PHE42	272	POPA04	466	PSF4	599
P19C80	669	PASC5	691	PER5A	450	PHE5162	272	POPH	91	PSF5	599

ITEM	PAGE	ITEM	PAGE	ITEM	PAGE	ITEM	PAGE	ITEM	PAGE	ITEM	PAGE	ITEM	PAGE
U PSFU1	599	U R797C	348	S RGO10B	469	S RONTC <small>NEW</small>	463	S RY4B	468	U TC91	594	U TC91	594
S PT10	271	U R798C	348	S RGO10F	469	S ROTB <small>NEW</small>	463	S RY4G	468	U TCL03	687	U TCL03	687
S PT15	271	U R799C	348	S RGO10G	469	S RPALA <small>NEW</small>	701	S RY4R	468	S TEN23	452	S TEN23	452
S PT20	271	U R9984	397	S RGO12B	469	S RPB1	509	S RY4RB	468	S TEN26	452	S TEN26	452
S PT25	271	U R9991	399	S RGO12F	469	S RPB2	509	S RY5B	468	S TEN33	452	S TEN33	452
S PT252	271	U R9991A	399	S RGO12G	469	U RPOLC	464	S RY5G	468	S TEN36	452	S TEN36	452
S PT30	271	U R9995	399	S RG07B	469	S RPPG1	508	S RY5P	468	S TEN39	452	S TEN39	452
S PT302	271	U R9995A	399	S RG07F	469	U RPPG10	507	S RY5PB	468	S TEN412	452	S TEN412	452
S PTF2	352	U RADE15MS	244	S RG07G	469	U RPPG13	507	S RY5R	468	S TEN46	452	S TEN46	452
U PTMOV	68	S RAMP4 <small>NEW</small>	412	S RGO7F	469	U RPPG17	507	S RY5RB	468	S TEN49	452	S TEN49	452
S PTO102 <small>NEW</small>	271	S RAMT2 <small>NEW</small>	412	S RGO7F	469	S RPPG2	508	S S01M	131	S TEN512	452	S TEN512	452
S PTO152 <small>NEW</small>	271	S RASF16 <small>NEW</small>	568	S RGO7F	469	S RPPG3	508	S S01S	129	S TEN56	452	S TEN56	452
S PTO202 <small>NEW</small>	271	S RASTML	568	S RGOR <small>NEW</small>	623	S RPPG4	508	U S02HM	119	S TEN612	452	S TEN612	452
S PTO252 <small>NEW</small>	271	S RBARRE	700	S RGP <small>NEW</small>	622	S RPU10B	472	U S02HS	118	S TEN712	452	S TEN712	452
S PTO272 <small>NEW</small>	271	U RBZANCO	646	S RGPR <small>NEW</small>	622	S RPU10F	472	S S05M	113	S TEN718	452	S TEN718	452
S PTO302 <small>NEW</small>	271	U RCAD4	701	U RGREF1	82	S RPU10G	472	S S05S	112	U TER60	698	U TER60	698
S PTO402 <small>NEW</small>	271	S RCAZP	595	U RRGREF2	86	S RPU12B	472	S S06M	119	U TEX <small>NEW</small>	702	U TEX <small>NEW</small>	702
S PTO62 <small>NEW</small>	271	S RCAZR	595	S RH10F	469	S RPU12F	472	S S06S	118	S TF1	343	S TF1	343
S PTO72 <small>NEW</small>	271	U RCOP14	282	S RH10G	469	S RPU12G	472	S S11M	133	S TH5M	593	S TH5M	593
S PTO82 <small>NEW</small>	271	U RCOP18	282	S RH15F	469	S RPU16B	472	S S11S	132	U TIMGC	624	U TIMGC	624
S PTO92 <small>NEW</small>	271	U RCOP18T	282	S RH15G	469	S RPU16F	472	S S12M	121	U TIMGG	624	U TIMGG	624
S PTS102 <small>NEW</small>	272	U RCOP24	282	S RH5B	469	S RPU16G	472	S S12S	120	S TJH10A <small>NEW</small>	306	S TJH10A <small>NEW</small>	306
S PTS152 <small>NEW</small>	272	U RCOP24P	282	S RH5F	469	S RPU18B	472	S S13M	115	S TJH7 <small>NEW</small>	306	S TJH7 <small>NEW</small>	306
S PTS202 <small>NEW</small>	272	U RCOP30	282	S RH5G	469	S RPU18F	472	S S13S	114	U TL30P	444	U TL30P	444
S PTS252 <small>NEW</small>	272	U RCOP36	282	S RH6B	469	S RPU18G	472	S S7861	180	U TL50	444	U TL50	444
S PTS272 <small>NEW</small>	272	S RCRUZ <small>NEW</small>	699	S RH6F	469	S RPZANCO	646	S S7915HL	172	S TMP-1	354	S TMP-1	354
S PTS302 <small>NEW</small>	272	S RCUCH <small>NEW</small>	699	S RH6G	469	S RSERRU	700	S S7916HL	172	S TMP-1/2	354	S TMP-1/2	354
S PTS402 <small>NEW</small>	272	S RCZ1 <small>NEW</small>	595	S RH7B	469	S RTG15B	471	S S7917HL	172	S TMP10	353	S TMP10	353
U PU10	303	S RCZ2 <small>NEW</small>	595	S RH7F	469	S RTG15F	471	S S7918HL	172	S TMP-2	354	S TMP-2	354
S PVS01 <small>NEW</small>	430	U RDIS	703	S RH7G	469	S RTG15G	471	S S7920HL	172	S TMP-3/4	354	S TMP-3/4	354
S PVS02 <small>NEW</small>	430	S RE4G	468	S RHACHA <small>NEW</small>	699	S RTG20B	471	S S7921HL	172	S TMP5	353	S TMP5	353
U PVU01	430	S RE4M	468	U RHHELF <small>NEW</small>	699	S RTG20F	471	S S7922HL	172	S TN512	512	S TN512	512
U PVU02	430	S RE4P	468	U RI1018 <small>NEW</small>	475	S RTG20G	471	S S7923HL	172	S TN538	512	S TN538	512
S R137066 <small>NEW</small>	399	S RE4R	468	U RI820 <small>NEW</small>	476	S RTI10B	471	S S7924HL	172	S TOLM3 <small>NEW</small>	643	S TOLM3 <small>NEW</small>	643
S R137068 <small>NEW</small>	399	S RE5G	468	S RIALJ2	687	S RTI10F	471	S SAV18	563	U TOPA <small>NEW</small>	689	U TOPA <small>NEW</small>	689
S R137071 <small>NEW</small>	399	S RESM	468	S RIALJ3	687	S RTI10G	471	S SAV24	563	U TOPCL <small>NEW</small>	689	U TOPCL <small>NEW</small>	689
S R137073	399	S RESP	468	S RIALT2	687	S RUNTB <small>NEW</small>	463	S SBM182	563	U TOPCS <small>NEW</small>	689	U TOPCS <small>NEW</small>	689
U R302	299	S RESR	468	S RIALT3	687	S RUTB <small>NEW</small>	463	S SBM1850 <small>NEW</small>	563	U TOPL <small>NEW</small>	689	U TOPL <small>NEW</small>	689
U R303	299	U RECA6A	704	S RILAJ2	687	S RV10B	470	S SBM242	563	U TOPMS <small>NEW</small>	689	U TOPMS <small>NEW</small>	689
U R307	300	S REPCUTF13	549	S RILAJ3	687	S RV10F	470	S SBM2450 <small>NEW</small>	563	U TOPRL <small>NEW</small>	689	U TOPRL <small>NEW</small>	689
U R309A	300	S REPCUTF25	547	S RILAT2	687	S RV10G	470	U SFTB	639	U TOPRS <small>NEW</small>	689	U TOPRS <small>NEW</small>	689
U R309B	300	S REPCUTF8	548	S RILAT3	687	S RV5B	470	U SFTR	639	U TOPS <small>NEW</small>	689	U TOPS <small>NEW</small>	689
U R313	299	S REPNT100	552	S RLLANA <small>NEW</small>	699	S RV5F	470	U SFT	639	S TOR2 <small>NEW</small>	412	S TOR2 <small>NEW</small>	412
U R5239T10	123	S REPNF5	552	S RMAP <small>NEW</small>	700	S RV5G	470	U SMA3	459	S TP5	593	S TP5	593
U R5239T15	123	S REPNF6	552	S RMARRO	699	S RV6B	470	S SMAT <small>NEW</small>	697	S TP5M	593	S TP5M	593
U R5239T20	123	S REPP10	508	S RMARRO4	700	S RV6F	470	S SMG5	459	S TP5MF	593	S TP5MF	593
U R5239T25	123	U REPTC1	594	S RMARRU	318	S RV6G	470	U SMG6	459	S TRA21	572	S TRA21	572
U R5239T27	123	S REVA <small>NEW</small>	622	S RMARRUC	318	S RV7B	470	U SMG7	459	S TRAG21 <small>NEW</small>	572	S TRAG21 <small>NEW</small>	572
U R5239T30	123	S REX5 <small>NEW</small>	552	U RMARTF	699	S RV7F	470	S T00	306	S TRF101	632	S TRF101	632
U R5239T40	123	S RFB05 <small>NEW</small>	453	S RMULT1 <small>NEW</small>	700	S RV7G	470	S T01	306	S TRF10A <small>NEW</small>	632	S TRF10A <small>NEW</small>	632
U R5239T45	123	S RFB09 <small>NEW</small>	453	S RMULT6	700	S RVN5B	470	S T02	306	S TRF171	632	S TRF171	632
U R5239T50	123	S RFB45 <small>NEW</small>	453	S RMULTI <small>NEW</small>	699	S RVN5F	470	S T03	306	S TRF172	632	S TRF172	632
U R5439T20	134	S RFE10B	472	S RN10B	470	S RVN5G	470	S T07	573	S TRH25	461	S TRH25	461
U R5439T25	134	S RFE10F	472	S RN10F	470	S RVN6B	470	S T10	573	U TRH3	461	U TRH3	461
U R5439T30	134	S RFE10G	472	S RN10G	470	S RVN6F	470	S T12	573	S TRH5 <small>NEW</small>	462	S TRH5 <small>NEW</small>	462
U R5439T40	134	S RFE15B	472	S RN5B	471	S RVN6G	470	S T14	573	S TRHB15 <small>NEW</small>	462	S TRHB15 <small>NEW</small>	462
U R5439T45	134	S RFE15F	472	S RN5F	471	S RVN7B	470	S T22	573	S TRHB2 <small>NEW</small>	462	S TRHB2 <small>NEW</small>	462
U R5439T50	134	S RFE15G	472	S RN5G	471	S RVN7F	470	S T25	573	S TRHLI2 <small>NEW</small>	462	S TRHLI2 <small>NEW</small>	462
U R5439T55	134	S RFE20B	472	S RN6B	471	S RVN7G	470	S T26	573	S TRH3	462	S TRH3	462
U R6226PE	225	S RFE20F	472	S RN6F	471	S RVNE5	469	S T27	573	S TRHP2	462	S TRHP2	462
U R6226PS	225	S RFE20G	472	S RN6G	471	S RVNE5B	469	U TARM <small>NEW</small>	701	S TRHP25	462	S TRHP25	462
U R6226T	225	S RFL0TAG <small>NEW</small>	699	S RN7B	471	S RVNE6	469	S TB08 <small>NEW</small>	66	S TRHP3	462	S TRHP3	462
U R794C	348	S RGC <small>NEW</small>	622	S RN7F	471	S RVNE6B	469	S TB09 <small>NEW</small>	66	S TRO05 <small>NEW</small>	467	S TRO05 <small>NEW</small>	467
U R795C	348	S RGENE <small>NEW</small>	701	S RN7G	471	S RVNE7	469	S TB12 <small>NEW</small>	66	U TC76	467	U TC76	467
U R796C	348	S RGO <small>NEW</small>	623	S RNIV5 <small>NEW</small>	699	S RVNE7B	469						
		S ROM25 <small>NEW</small>	643	S ROM25 <small>NEW</small>	643								

ITEM	PAGE	ITEM	PAGE	ITEM	PAGE	ITEM	PAGE	ITEM	PAGE	ITEM	PAGE
U TRO2 <small>NEW</small>	467	U UCL20	394	U UFTP6	557	U UH1238M	335	U UH2737SW	336	U UHW4	338
U TRO3 <small>NEW</small>	467	U UCL26	394	U UFTP7	557	U UH1240	334	U UH2738SW	336	U UJMT87 <small>NEW</small>	496
U TRO5 <small>NEW</small>	467	U UCL26F	394	U UFTP8	557	U UH1241M	335	U UH2740SW	336	U UMAT	697
U TS10	572	U UCL5	394	U UFTP86 <small>NEW</small>	554	U UH1242M	335	U UH2741SW	336	U UMC66	433
U TS12	572	U UD112	428	U UFTP87 <small>NEW</small>	554	U UH1244	334	U UH2741SWM	336	U UMC6D	433
U TSA12	572	U UD12	428	U UFTP88 <small>NEW</small>	554	U UH1246	334	U UH2742SW	336	U UMC68	433
U TSAG12 <small>NEW</small>	572	U UD179	427	U UFTR10	557	U UH1246M	335	U UH2744SW	336	U UMC6V	434
U TSF12 <small>NEW</small>	572	U UD18	428	U UFTR6	557	U UH1248	334	U UH2746SW	336	U UMM01	432
U TSSG12	572	U UD226	429	U UFTR7	557	U UH1250	334	U UH2746SWM	336	U UMM12	432
U TSWG12	572	U UD333	429	U UFTR8	557	U UH1250M	335	U UH2747SW	336	U UMT81 <small>NEW</small>	496
U TT2	641	U UD334	429	U UH00FG	339	U UH1251M	335	U UH2748SW	336	U UMT82 <small>NEW</small>	496
U U3500A	215	U UD337	429	U UH01FG	339	U UH1252	334	U UH2750SW	336	U UMT83 <small>NEW</small>	496
U U3500AM	215	U UD370	430	U UH02FG	339	U UH1254	334	U UH2750SWM	336	U UMT84 <small>NEW</small>	496
U U3500B	215	U UD70	432	U UH03FG	339	U UH1256	334	U UH2751SWM	336	U UNI12A	442
U U3500BM	215	U UD71TLAC	430	U UH1164	335	U UH1258	334	U UH2754SW	336	U UNI14A	442
U U3519M	215	U UD80	432	U UH1200F	334	U UH1260	334	U UH2755SWM	336	U UNI18A	442
U U3521M	215	U UD85	427	U UH1200FM	335	U UH1885	340	U UH2756SW	336	U UNI24	441
U U3522M	215	U UD88	429	U UH1200G	334	U UH1886	340	U UH2760SWM	336	U UNI24A	442
U U3524	215	U UEC31	640	U UH1200H	334	U UH206	338	U UH2765SWM	336	U UNI24D	441
U U3524M	215	U UEXBT	356	U UH1200KM	335	U UH2292	338	U UH2770SWM	336	U UNI36A	442
U U3526	215	U UFMB10	555	U UH1200QM	335	U UH2615	337	U UH2775SWM	336	U UNI48	441
U U3527M	215	U UFMB12	555	U UH1206M	335	U UH2616SW	336	U UH278	338	U UNI48A	442
U U3528	215	U UFB8	555	U UH1207M	335	U UH2617SW	336	U UH2780SWM	336	U UNI48D	441
U U3530	215	U UFM8	555	U UH1208M	335	U UH2618SW	336	U UH2785SWM	336	U UNI48D	441
U U3530M	215	U UFM88	555	U UH1209M	335	U UH2619SW	336	U UH651	340	U UNT12	442
U U3532	215	U UFM88 <small>NEW</small>	553	U UH1210	334	U UH2620SW	336	U UH652	340	U UP125	489
U U3532M	215	U UFM88 <small>NEW</small>	553	U UH1210M	335	U UH2621SW	336	U UH653	340	U UP125R046	489
U U3534	215	U UFM88 <small>NEW</small>	553	U UH1211M	335	U UH2622SW	336	U UH654	340	U UP700	494
U U3536	215	U UFM88 <small>NEW</small>	553	U UH1211M	335	U UH2623	337	U UH665	340	U UP711	493
U U3536M	215	U UFM88 <small>NEW</small>	553	U UH1212	334	U UH2623	337	U UH66FG	339	U UP711K	493
U U3537M	215	U UFM88 <small>NEW</small>	553	U UH1212M	335	U UH2623SW	336	U UH67FG	339	U UP711K5	494
U U3538	215	U UFM88 <small>NEW</small>	553	U UH1213M	335	U UH2624SW	336	U UH68FG	339	U UP715	493
U U3538M	215	U UFM88 <small>NEW</small>	553	U UH1214	334	U UH2627SW	336	U UH708	334	U UP722	501
U U3540	215	U UFM88 <small>NEW</small>	553	U UH1214M	335	U UH2628SW	336	U UH710	334	U UP731	499
U U3541M	215	U UFM88 <small>NEW</small>	553	U UH1215M	335	U UH2629SW	336	U UH712	334	U UP731AK	40 y 502
U U3542	215	U UFM88 <small>NEW</small>	553	U UH1216	334	U UH2630	337	U UH715	334	U UP731AKM	40 y 502
U U3544	215	U UFM88 <small>NEW</small>	553	U UH1216M	335	U UH2630SW	336	U UH718	334	U UP731K	39 y 501
U U3546	215	U UFM88 <small>NEW</small>	553	U UH1217M	335	U UH2631SW	336	U UH71FG	339	U UP731KM	39 y 501
U U3546M	215	U UFM88 <small>NEW</small>	553	U UH1218	334	U UH2632SW	336	U UH71FGS	339	U UP734HK	39 y 501
U U3548	215	U UFM88 <small>NEW</small>	553	U UH1218M	335	U UH2633SWM	336	U UH724	334	U UP734HKM	39 y 501
U U3550	215	U UFM88 <small>NEW</small>	553	U UH1219M	335	U UH2635SWM	336	U UH72FG	339	U UP766	492
U U3550M	215	U UFM88 <small>NEW</small>	553	U UH1220	334	U UH2650SWM	336	U UH72FGS	339	U UP772HAK	41 y 504
U U3552	215	U UFM88 <small>NEW</small>	553	U UH1220M	335	U UH268	338	U UH73FG	339	U UP772HAKM	41 y 504
U U3554	215	U UFM88 <small>NEW</small>	553	U UH1221M	335	U UH2716SW	336	U UH73FGS	339	U UP772HK	41 y 504
U U3555M	215	U UFM88 <small>NEW</small>	553	U UH1221M	335	U UH2717SW	336	U UH74FG	339	U UP772HKM	41 y 504
U U3556	215	U UFM88 <small>NEW</small>	553	U UH1222	334	U UH2718SW	336	U UH74FGS	339	U UP776K	40 y 499
U U3558	215	U UFM88 <small>NEW</small>	553	U UH1222M	335	U UH2719SW	336	U UH810	337	U UP776KM	40 y 499
U U3560	215	U UFM88 <small>NEW</small>	553	U UH1223M	335	U UH2720SW	336	U UH812	337	U UP779	488
U U3562	215	U UFM88 <small>NEW</small>	553	U UH1224	334	U UH2721SW	336	U UH814	337	U UP780	488
U U3564	215	U UFM88 <small>NEW</small>	553	U UH1224M	335	U UH2722SW	336	U UH818	337	U UP785	511
U U3565M	215	U UFM88 <small>NEW</small>	553	U UH1225M	335	U UH2723SW	336	U UH824	337	U UP785H	511
U U3568	215	U UFM88 <small>NEW</small>	553	U UH1226	334	U UH2724SW	336	U UH86A-1/4	338	U UP785S	486
U U3572	215	U UFM88 <small>NEW</small>	553	U UH1226M	335	U UH2724SWM	336	U UH86A-1X12	338	U UP788R	511
U U3576	215	U UFM88 <small>NEW</small>	553	U UH1227M	335	U UH2726SW	336	U UH86A-1X8	338	U UP789HR	512
U U3580	215	U UFM88 <small>NEW</small>	553	U UH1228	334	U UH2727SW	336	U UH86A-3/4X12	338	U UP800VE	492
U U3582	215	U UFM88 <small>NEW</small>	553	U UH1228M	335	U UH2727SWM	336	U UH86A-3/4X8	338	U UP800V1	492
U UCD10	393	U UFM88 <small>NEW</small>	553	U UH1229M	335	U UH2728SW	336	U UH86A-3/8	338	U UP835	486
U UCD33	393	U UFM88 <small>NEW</small>	553	U UH1230	334	U UH2729SW	336	U UH86A-7/8X12	338	U UP854	489
U UCD5	393	U UFM88 <small>NEW</small>	553	U UH1230M	335	U UH2730SW	336	U UH86A-7/8X8	338	U UP857	489
U UCD6	393	U UFM88 <small>NEW</small>	553	U UH1232	334	U UH2730SWM	336	U UH9616	338	U UP860K	496
U UCD7	393	U UFM88 <small>NEW</small>	553	U UH1232M	335	U UH2731SW	336	U UH9686	338	U UP861A	490
U UCD8	393	U UFM88 <small>NEW</small>	553	U UH1233M	335	U UH2732SW	336	U UH9687	338	U UP865S	510
U UCD9	393	U UFM88 <small>NEW</small>	553	U UH1233M	335	U UH2732SWM	336	U UHC910	337	U UP869P	510
U UCL18	394	U UFM88 <small>NEW</small>	553	U UH1234	334	U UH2734SW	336	U UHW1	338	U UP870A	491
		U UFM88 <small>NEW</small>	553	U UH1234M	335	U UH2735SW	336	U UHW2	338	U UP874	487
		U UFM88 <small>NEW</small>	553	U UH1236	334	U UH2736SW	336	U UHW3	338	U UP87430	487
		U UFM88 <small>NEW</small>	553	U UH1237M	335	U UH2736SWM	336				
		U UFM88 <small>NEW</small>	553	U UH1238	334						

# 28 NUMERICAL INDEX

ITEM	PAGE	ITEM	PAGE	ITEM	PAGE	ITEM	PAGE	ITEM	PAGE	ITEM	PAGE
UP879	511	USCO1C	616	USGDC	627	USLO14	608	USZL65	629	X28F5	78
UP881	483	USCO1G	616	USGDG	627	USLO15	608	USZL7	629	X28F6	78
UP88135A	483	USCO1M	616	USGDM	627	USLO16	609	USZL75	629	X28F7	78
UP884	510	USCH11	617	USGDY	627	USLO17	609	USZL8	629	X28F9	78
UP886	494	USCH12	617	USGEC	627	USLO18	609	USZL85	629	X28-S10	78
UP886H	495	USCH13	617	USGEG	627	USLO19	608	USZL9	629	X28-S3	78
UP886HK	495	USCH14	617	USGEM	627	USLO20	608	USZM2	630	X28-S4	78
UP886HKM	495	USCH21	617	USGEX	627	USLG1	611	USZM3	630	X28-S6	78
UP886K	494	USCH22	617	USGGG	624	USL1P1	616	USZM4	630	X28-S8	78
UP886KM	494	USCH23	617	USGGM	624	USLV2	616	USZM5	630	X30U5	72
UP890A	490	USCH24	617	USGGX	624	USLV6	616	USZM6	630	X35F4	76
UP898-6B	506	USCH31	617	USGHC	628	USLV9	616	USZM7	630	X35F7	76
UPC727	497	USCH32	617	USGHG	628	USM1	615	USZP4	629	X35G2	76
UPC731K	39 y 497	USCH33	617	USGHH	628	USM2	615	USZP5	629	X35G4	76
UPC731KM	39 y 497	USCH34	617	USGHX	628	USO2	612	USZP6	629	X35PM	77
UPC776K	40 y 504	USCH41	617	USGIG	624	USO3	612	USZP65	629	X41M11	80
UPC776KM	40 y 504	USCH42	617	USGIM	624	USPF1	616	USZP7	629	X41S8	81
UPR2	481	USCH43	617	USGIX	624	USS1	623	USZP75	629	X59P	77
UPS15	645	USCH44	617	USGLA	625	USS2	623	USZP9	629	X59WF	76
UPS25	645	USCH51	617	USGLO	625	USS3	623	USZS10	629	XGAC1	76
UPTC30A	487	USCH52	617	USGLS	625	UST01	612	USZS11	629	XGAC2	76
UPTC40A	487	USCH53	617	USGMC	624	UST02	612	USZS5	629	XGAD	77
UPTC55A	488	USCH54	617	USGMM	624	UST03	612	USZS6	629	XGAL	77
UPWL2	481	USCH61	617	USGVC	624	UST04	612	USZS65	629	XGAT	77
UPWL3	481	USCH62	617	USGVG	624	USZA10	629	USZS7	629	ZP5M	593
UPWL4	481	USCH63	617	USGVM	624	USZA5	629	USZS75	629	ZP5MF	593
UPWL6	481	USCH64	617	USGVX	624	USZA6	629	USZS8	629	ZP7M	593
UPX727	497	USCH71	617	USHO1R	606	USZA65	629	USZS85	629	ZP7MF	593
UPX731	498	USCH72	617	USHO1Y	606	USZA7	629	USZS9	629		
UPX731A	498	USCH73	617	USHO2B	606	USZA75	629	USZT10	630		
UPX731B	498	USCH74	617	USHO2P	606	USZA8	629	USZT5	630		
UPX776	499	USCH81	617	USHO2R	606	USZA85	629	USZT6	630		
UPX893	500	USCH82	617	USHO2W	606	USZA9	629	USZT65	630		
URR2284011	207	USCH83	617	USHO4W	606	USZAH65	630	USZT7	630		
USA01A	613	USCP1	615	USIM11	621	USZC10	629	USZT75	630		
USA01B	613	USCR1	615	USIM12	621	USZC11	629	USZT8	630		
USA02A	613	USCS4	605	USIM13	621	USZC12	629	USZT85	630		
USA02B	613	USCS4R	605	USIM14	621	USZC5	629	USZT9	630		
USA3A	613	USCS5	605	USIM21	620	USZC6	629	VAS100	507		
USA3B	613	USCS5R	605	USIM22	620	USZC65	629	VAS600	507		
USA4A	613	USCS6	605	USIM23	620	USZC7	629	VPB1	509		
USA4B	613	USCS6R	605	USIM24	620	USZC75	629	WER24M	211		
USA5A	613	USF01C	619	USIM31	620	USZC8	629	WER30M	211		
USA5B	613	USF01EX	619	USIM32	620	USZC85	629	WER32M	211		
USA6A	613	USF01G	619	USIM33	620	USZC9	629	WER36M	211		
USA6B	613	USF01M	619	USIM34	620	USZD10	629	WER46	211		
USA7A	613	USF01X	619	USIM41	620	USZD5	629	WER48	211		
USA7B	613	USF02C	619	USIM42	620	USZD6	629	WER54	211		
USA8A	613	USF02EX	619	USIM43	620	USZD65	629	WER60	211		
USA8B	613	USF02G	619	USIM44	620	USZD7	629	X22W1	77		
USA9A	613	USF02M	619	USIM50	621	USZD75	629	X22W4	77		
USA9B	613	USF02X	619	USK02	622	USZD8	629	X27I3	82		
USB32C	696	USF03C	619	USK03	622	USZD85	629	X27M6	81		
USB32M	696	USF03EX	619	USK04	622	USZD9	629	X27M6A	81		
USB64L	697	USF03G	619	USK05	622	USZH10	630	X27M6N	81		
USB64S	697	USF03M	619	USL001	608	USZH5	630	X27M7	81		
USBIC10	631	USF03X	619	USL003	608	USZH6	630	X27M7A	81		
USBIC4	631	USF04G	618	USL004	608	USZH7	630	X27M7N	81		
USBIC5	631	USF04M	618	USL005	609	USZH75	630	X27S4	81		
USBIC6	631	USF04X	618	USL006	608	USZH8	630	X27S4A	81		
USBIC7	631	USFS1	611	USL007	608	USZH85	630	X27S4N	81		
USBIC8	631	USGCC	624	USL008	608	USZH9	630	X27S9	81		
USBIC9	631	USGGG	624	USL010	607	USZL10	629	X27S9A	81		
USBL01	615	USGCM	624	USL011	607	USZL5	629	X27S9N	81		
USBL2	615	USGCX	624	USL012	607	USZL6	629	X28F10	78		

1" drive air impact wrenches	506	Ball pein hammers	319	Chopping axes	569
1" drive hand sockets	142	Bar clamps	365	Circle cutter	542
1" drive impact sockets	175	Barrel bolts	692	Clamp pliers	390
1" drive sockets	142	Barrel wrench	424	Clamp-on multimeters	429
1" square composite pneumatic impact wrenches	500	Bars	308	Clamps	363
1/2" drive hand sockets	128	Bastard files	553	Claw hammers	321
1/2" drive sockets	128	Battery chargers	475	Click torque wrenches	226
1/2" drive air impact wrenches	497	Bearing removers	376	Closet accessories	686
1/2" drive impact sockets	163	Bearing separator	357	Closet rails	687
1/2" drive socket sets and air ratchets	495	Bicycle locks	670	Club hammers	318
1/2" square composite pneumatic impact wrenches	501	Bimaterial handle electronic pliers	294	Coated cut resistant gloves	627
1/4" drive impact sockets	157	Bimaterial handle flexible putty knives	596	Cobalt drill bits	524
1-1/2" drive impact sockets	178	Bimaterial handle nut screwdrivers	234	Cold chisels	311
18 V li-ion cordless power tools	475	Bimaterial handle screwdrivers	232	Combination drive socket sets	96
20 V li-ion cordless impact wrenches	474	Bimaterial handle screwdrivers combination set	234	Combination lock box	655
2-1/2" drive impact sockets	179	Bi-metal hacksaw blades	563	Combination padlocks	666
3/4" drive hand sockets	138	Bimetal hole saws	542	Combination sets	24
3/4" drive sockets	138	Bits	262	Combination tool set	32
3/4" drive air impact wrenches	500	Black combination wrenches	198	Combination tool set 1000 V	326
3/4" drive impact sockets	170	Black drill bits	528	Combination wrenches	187
3/4" square composite pneumatic impact wrenches	499	Blade replacements	595	Combined socket sets	96
3/8" drive hand sockets	118	Blades	550	Component holding clamp	295
3/8" drive sockets	118	Block and tackle	463	Compressor accessories	480
3/8" drive impact sockets	159	Blue handle screwdrivers	240	Concrete chisels	316
3/8" drive socket sets and air ratchets	494	Bodywork hammers	372	Concrete drill bits	515
3/8" square composite pneumatic impact wrenches	501	Bolt cutters	282	Cones	632
<b>A</b> Abrasive brushes	540	Booster cables	395	Connector sets	579
Abrasive stones	560	Boots	629	Connectors	481
Abrasive wheels	561	Bow saw	569	Construction line	589
Accessories for hand sockets	143	Box wrenches	208	Contractor hoses	583
Accessories for impact sockets	179	Brackets of steel	641	Coples	481
Accordion-style boxes	64	Brake lining thickness gauge	375	Cordless angle grinder 18 V	475
Adapter with pin	280	Brake pad spreaders	376	Cordless angle grinders	476
Adapters	143	Brake spring pliers	375	Cordless hammer drill 18 V	475
Adapters for verifier	392	Brick trowels	589	Cordless impact driver 18 V	475
Adhesive tapes	638	Bronze hammers	318	Cordless impact driver 20 V	476
Adjustable wrench	184	Bronze punches	313	Cordless impact wrenches	476
Adjustable wrenches	184	Brooms	566	Corner brackets	641
Adjustable wrenches 1000 V	328	Brown packing tape	638	Cotton gloves	628
Adjustable wrenches with handle	184	Brushes	600	Countersinks	534
Adjuster puller	356	Brushes, rollers and painting accessories	601	Cowhide leather sleeves	623
Air drills	511	Bucket grease pump	422	Cowhide welding gloves	625
Air hammers	493	Bucket oil extractor pump	418	Cranes	408
Air hammers and accessories	493	Bucket opener	602	Crimping pliers	299
Air hoses	482	Bungee cords	460	Cross lug wrench	394
Air impact wrenches	497	Bus lug nut wrench	393	Crowfoot wrenches	127
Air impact wrenches sets	40	<b>C</b> Cabinet accessories	83	Current tester	396
Air needle scaler	489	Cabinet screwdrivers	233	Cushion grip handle interchangeable screwdrivers	245
Air nibbler	486	Cabinets	76	Cushion grip handle screwdrivers	236
Air polishers	510	Cable and wire cutters	305	Cut resistant gloves	627
Air ratchets	494	Cable lock with key	669	Cutter tile plier	596
Air regulators	481	Cable pliers	298	Cutters	547
Air sander	490	Cable staples	634	Cylindrical door knobs	681
Air scissors	486	Calipers	439	Cylindrical handles	676
Air screwdrivers with torque control	487	Cape chisels	313	<b>D</b> Damaged thread lug nut remover	378
Airbrush	509	Caps	698	Dead blow hammer	318
Alarm padlocks	670	Car ramps	412	Deadbolts	677
Allen keys	248	Carbide wheels	561	Dies for threader	354
Aluminum oxide mounted bits	560	Carbon scrapers	323	Digital locks	682
Aluminum oxide wheels	561	Carpenter's brushes	541	Digital power clamp multimeter	430
Aluminum pipe wrenches	349	Carpenter's pincers	305	Displays	700
Aluminum tapes	637	Carpenter's planes and scrapes	541	Doble head inflator	480
Amber handle nut drivers	238	Carving chisels	553	Dog chains	636
Amber handle screwdriver	237	Cash boxes	655	Dollies	454
Anatomic face shield	611	Caster set for jobsite boxes	64	dolly blocks	371
Angle air grinders	489	Caster wheels for trunk	64	Door guard with chain	691
Annular cutters	545	Casters	468	Door hasps	693
Anti splash funnels	419	Caulking guns	599	Door seal	690
Anti-pry padlocks	656	Center drill bits	534	Door stops	689
Anti-slip tapes	631	Center drills	534	Double action hinges	653
Anti-vibration hammers	316	Centering points	314	Double drive ratchets	151
Auger drill bits	519	Chain hooks	448	Double-arm utility hooks	74
Automatic pullers	356	Chain pipe cutters	345	Drain cleaners	342
Automotive multimeters	429	Chain safety tool set	388	Drift punches	313
Automotive tool sets	30	Chain turbobuckles	452	Drive hand sockets 1/4"	112
Automotive tools	370	Chain wrench replacement parts	348	Drive impact adapters	179
Aviation industrial sets	31	Chain wrenches	348	Drive sliding t-handles	143
Aviation tin snips	305	Chains	446	Drive sockets 1/4"	112
Axes	569	Chalk line	444	Drive speed handles	144
<b>B</b> Back support belts	618	Chin straps	607	Drive torx bit sockets	116
Backpacks	698	Chisel holder	313	Drum brake adjusting tool	375
Ball mounts	370	Chisels	311 y 515	Drywall stils	646

# ALPHABETICAL INDEX

Ductile iron clamps	364	Grease guns	419	Injector cleaner	389
Dumper	599	Grease pumps	423	Inspection mirrors	400
<b>E</b> Ear protection	612	Groove joint pliers	295	Insulated tools	326
Elastic back support belts	619	Groover	599	Insulating tapes	639
Electric chain hoists with chain brake system	463	<b>H</b> Hacksaw frames	562	Interchangeable bit screwdriver	244
Electric hoists	463	Hacksaws	562	Interchangeable bits	276
Electrician pliers	288	Half cut pincers	305	Interchangeable cap	321
Electrician tool sets	32	Hammer pullers	358	Intermediate chest	86
Electronic oil extractor pumps	416	Hammers	316	Internal pipe wrenches	184
Electronic repair tool set	247	Hammers with caps	320	Irrigation accessories	577
Electronics Pliers	293	Hand impact interchangeable bit screwdriver	243	Irrigation hoses	584
Electronics tools	427	Hand pallet truck spare parts	463	Irrigation nozzles	579
Endless hose clamps	636	Hand pallet trucks	461	Irrigation water spray guns	580
Engine cleaning blowgun	390	Hand pullers	467	<b>J</b> Jack adapter	408
Engine timing tools	392	Hand saws	564	Jack stands	412
Engine tools	384	Hand socket and accessory set	327	Jacks	402
Entry latches	671	Hand sockets 1/4"	114	Jaw pullers	360
ESD Precision Screwdriver	246	Hand trowels	598	Jaws for bench vises	367
ESD Screwdrivers	246	Handcarts	454	Jaws for pipe wrench	351
Expansion wrenches 1000 V	328	Handle sets	674	Jaws for Stillson wrench	351
Extensions	144	Handle taping knives	596	Jobsite boxes	64
Extensions for hand sockets	144	Handles for impact sockets	181	Jumper cables	395
Extra-long combination wrenches	192	Handles for sockets	181	<b>K</b> Keychains	696
Eye hooks	448	Handles with mortise mechanism	673	Keys boxes	655
<b>F</b> Face hammers	320	Harmonic balancer pullers	356	Knee pads	622
Fan puller	391	Harness	613	Knives	546 y 550
F-Clamps	365	Hat hooks	693	Knob locks	678
Feeler gauges	385	Heavy-duty fixed jaw pullers	363	Knob sets	678
Fencing plier	296	Helmets	606	Knot wire	540
Files	553	Hex key set	253	<b>L</b> Ladders	641
Filter regulators	481	Hex power bits	272	Laminated padlocks	665
Fish tapes	598	Hexagonal bit adapter	279	Laser distance meters	436
Fixed cabinets	76	Hexagonal bit sockets	117	Laser levels	442
Fixed steel workbenches	74	High-leverage box-end wrenches	217	Latex gloves	628
Fixed workstation	76	High-leverage wrench bars	216	Lather tools bits	534
Flare nut wrenches	214	High-leverage wrenches	217	Leaf rakes	567
Flaring tools	343	High-security padlocks	656	Leather cases	92
Flat striking wrenches	219	High-speed steel drill bits	522	Leather gloves	625
Flex head wrenches	199	High-speed steel taps	558	Leather tool cases	92
Flexible cable hoses	634	Hinge handles	145	Letters	316
Flexible combination wrenches	199	Hinge handles for hand sockets	145	Level hoses	589
Flexible oilers	414	Hinges	652	Levels	441
Flexible putty knives	596	Hinges for ironwork	654	Lever action oil extractor pumps	418
Flexible sockets	116	Hoes	574	Lever oil extractor pumps	417
Flexible wrenches	199	Hoists	463	L-handles	146
Floats	597	Hole saw	543	L-handles for hand sockets	146
Flooring knife	546	Hollow punch	324	Lifelines	616
Fluid extractor pumps	416	Hones	374	Lifting straps	457
Folding hex keys	259	Honing stones	560	Lifting table carts	460
Forged C-clamps	364	Honing tools	384	Lineman belts	616
Forged forks	566	Hook and eye turnbuckles	452	Linemen's pole strap	615
Fork separators	374	Hooks	448	Linemen's safety belt	447
Fruit collector	571	Hose clamp pliers	390	Links	467
Fuel injector clean set	389	Hose clamps	636	Load trolleys	454
Fuel line disconnect tools	383	Hose PVC cutters	573	Loading platforms	301
Fuel testers	392	Hose reel	399	Locking pliers	671
Furniture for exhibition	702	Hoses	582	Locks	82
<b>G</b> Galvanized chains	447	Hub center sockets	376	Locks and keys for cabinets	82
Galvanized steel chains	447	Hub puller	356	Locks for aluminum doors	82
Garden brooms	566	Hydraulic body repair kits	372	Locks for cabinets	77
Garden hoses	582	Hydraulic bottle jack	405	Long hooks for series	257
Garden leaf broom	566	Hydraulic door closers	688	Long L-Type Allen keys	257
Garden trowel	575	Hydraulic engine cranes	409	Long L-Type hex keys	295
Gardener's bow	569	Hydraulic jacks	402	Long reach pliers	434
Gardening gloves	628	Hydropneumatic jack	405	Long tapes	248
Gasket scraper	401	<b>I</b> Impact adapters	179	Long T-handle Allen keys	590
Gasoline generator	478	Impact extensions	180	Long wood handle shovels	572
Gate trolleys	687	Impact handles	615	Loppers	257
Gauges	357	Impact shock absorbers	180	L-Shape Allen keys	253
Gear and bearing separator	357	Impact socket extensions	157	L-Type hex key set	331
Gear puller	225	Impact sockets	156	L-type hex keys 1000 V	414
Gear spare parts	478	Impact sockets and accessories	181	Lubricant handling equipment	393
Generators	534	Impact universal joints	219	Lug nut wrench	571
Glass and tile drill bits	545	Impact wrenches	475	<b>M</b> Machetes	401
Glass cutter	624	Impact wrenches 18 V	476	Magnetic pick-up tools	400
Gloves	356	Impact wrenches 20 V	28	Magnetic trays	243
Goat leg pulley puller	704	Industrial basic tool sets	26	Magnetizer-demagnetizer	655
Gondola bars	703	Industrial intermediate sets	24	Mailboxes	323
Gondola shelves	96	Industrial master sets	24	Mallets	464
Go-through sockets	553	Industrial sets	44	Manual hoists	640
Gouges	637	Industrial sets with modular organization system	432	Manual staplers	314
Gray tapes		Infrared thermometer		Marking points	



Masking tape	602	Offset wrenches	221	Power bits	268
Mason's line	589	Oil control guns	424	Power connectors	395
Mats	697	Oil extractor pumps	416	Power drive hexagonal bits	272
Measures tape	436	Oil filter wrench	381	Power drive slotted bits	268
Measures tapes	436	Oil filters accessories	380	Power drive square bits	272
Measuring tapes	437	Oilers	414	Power drive torx bits	272
Measuring tool set	39	One-handed pneumatic grease gun	490	Power nut driver bits	267
Measuring tool sets	39 y 442	Open-end wrenches	206	Power nut setters	267
Mechanic creeper casters	399	Open-end wrenches 1000 V	328	Power tools	474
Mechanic creepers	398	O-rings	182	Power tools batteries	474
Mechanic gloves	624	O-rings for impact sockets	182	Power tools chargers	474
Mechanic stethoscope	389	<b>P</b> Packing tapes	638	Precision screwdriver sets	247
Mechanic stool	397	Padlocks	656	Precision screwdrivers	246
Mechanic stool casters	397	Padlocks with alarm	657	Precision vises	363
Mechanic stools	397	Paint brushes	600	Preset torque wrenches	226
Mechanic tool sets	35	Paint mixers	600	Pressure tester	391
Mechanic's wrenches	206	Paint roller frames	601	Price hooks	703
Mechanical jacks	404	Paint spray guns	507	Promotional displays	700
Mechanic's pliers	296	Paint telescopic extensions	602	Promotional items	696
Mesh screen	644	Paint tray	602	Promotional pens	697
Mesh tarps	643	Panic bars	684	Promotional textiles	698
Metal boxes	64	Parking stop	632	Protective equipment	604
Metal drill bits	522	Pear-head ratchet	278	Pruning shears	572
Metal jobsite boxes	64	Personal protective equipment	604	Pullers	356
Metal rod tylers	588	Phosphate finish combination wrenches	198	Pulley holder	384
Metal stake	578	Pick mattock	593	Pulley puller	356
Metal tool boxes	67	Picks	593	Pulley with hook for wire	451
Metal Toolboxes	65	Pilot drill arbors	543	Pulleys	451
Metal utility cart with drawers	72	Pin punches	314	Pump sprayers	576
Metal utility carts	72	Pins	182	Punches and points	313
Metallic fold-out toolbox	64	Pins for impact sockets	182	Punches and points	313
Micrometers and vernier caliper	432	Pipe benders	347	Putty knives	596
Mini cranes	467	Pipe chain vise	352	PVC boots	631
Mini electronics pliers	294	Pipe clamp	366	<b>Q</b> Quick hooks	447
Mini pipe cutters	345	Pipe cutter	344	<b>R</b> Racks for tools	699
Mixing hoes	588	Pipe cutter blades	344	Radiator pressure test master	391
Mobile work center	85	Pipe cutters	344	Raffias	453
Modular boxes	67	Pipe threaders	353	Railroad tool sets	34
Modular organization sets	45	Pipe tools	342	Rain suits	620
Modular plastic tool boxes	67	Pipe wrench	349	Raincoats	620
Morse drill bits	533	Pipe wrench jaws	351	Rakes	568
Mosquito netting fabrics	644	Pipe wrenches	349	Ratches	147
Motorcycle tire wrench	379	Pipe yoke vise	352	Ratchet tie down strap	459
Mounted points	560	Piston ring oppressor set	389	Ratchets for hand sockets	147
Mounted points for castings	561	Pitchforks	566	Rebar tier	588
Multimeter accessory	430	Pitman puller	357	Rebar wrenches	589
Multimeter sets	426	Planer blades	542	Reciprocating air saw	483
Multimeters	427	Plastic cover	703	Red handle screwdrivers	239
Multimeters sets with tools	427	Plastic stacking bins	72	Red sandpapers	642
Multipurpose case	90	Plastic ties	636	Reflective triangles	632
Multipurpose movable panel	77	Plastic tool boxes	72	Reflective vests	617
Multi-tool knives	552	Plastic toolboxes	65	Reinforced tarps	643
Multi-tool pliers	297	Plastic toolboxes	74	Residential locks	671
<b>N</b> Nail pry tools	380	Plastic utility cart	454	Retaining ring pliers	283
Needle torque wrenches	226	Platform carts	454	Reusable earplugs	612
Non-sparking screwdrivers	338	Pliers	283	Reversible chain wrench	348
Non-sparking adjustable wrenches	334	Pliers 1000 V	332	Reversible jaw pullers	362
Non-sparking brushes	340	Pliers sets	55	Reversible ratchets	147
Non-sparking chisels	338	Plug remover	356	Revolver type screwdriver	245
Non-sparking combination wrenches	335	Plumb bobs	593	Ribe bit sockets	126
Non-sparking expansion wrenches	334	Plumbers tool set	41	Rigid back support belts	618
Non-sparking flat striking wrenches	336	Plumbing set	353	Riveters	645
Non-sparking hammers	339	Plumbing snake	342	Rivets	646
Non-sparking offset striking wrenches	336	Pneumatic brad nails	484	Roll door padlocks	667
Non-sparking pipe wrenches	337	Pneumatic cutter	487	Roller cabinets	79
Non-sparking pliers	338	Pneumatic drill	511	Roller refills	601
Non-sparking putty knives	340	Pneumatic grinder	496	Ropes	453
Non-sparking spline wrenches	335	Pneumatic impact wrench	497	Roughing end mills	544
Non-sparking structural wrenches	337	Pneumatic moto tools	496	Round files	556
Non-sparking tools	334	Pneumatic nailers	483	Router drill bits	520
Non-sparking wedges	338	Pneumatic nailers and staplers	483	R-series handle screwdriver	239
Non-sparking riveters	334	Pneumatic polishers	510	Rubber head mallet	323
Notched hand trowels	598	Pneumatic riveters	510	Rubber straps	460
Notebook	696	Pneumatic staplers	485	<b>S</b> Sae industrial railroad maintenance tool sets	34
Numbers	694	Pneumatic tool sets	39 y 497	Safety boots	629
Nylamid socket set	377	Pneumatic tools	483	Safety clothing	623
Nylamid sockets	377	Pneumatic/air accessories	480	Safety cones	632
Nylon gloves	627	Polish chains	446	Safety footwear	629
<b>O</b> Obstruction wrenches	210	Polypropylene rope	453	Safety glasses	607
Octagonal hammers	316	Portable toolboxes	64	Safety gloves	624
Offset cabinet screwdriver	243	Portable workbenches	363	Safety goggles	611
Offset striking wrenches	221	Post hole digger	574	Safety helmets	606
		Post hole diggers	574		

# ALPHABETICAL INDEX

Safety knee pads	622	Steel fish tapes	598	Truck wheel sockets	377
Safety toolboxes	65	Steel knives	546	Truck wrench	381
Safety vests	617	Steel padlock sets	661	Tube benders	347
Safety waterproof tool boxes	65	Steel padlocks	662	Tubular door knobs	680
Safety wire twist plier	295	Steel wire ropes	446	Tubular handles	674
Sanders	490	Steel wire ropes with thimbles	446	Turnbuckles	452
Sandpaper	642	Steering tools	374	Twist socket set with punch	359
Satin finish combination wrenches	193	Step drill bits	533	Two-dimensional hinges	653
Satin finish jumbo combination wrenches	194	Stiff putty knives	596	<b>U</b> Universal joints	154
Satin-finish sae service wrenches	215	Stillson	349	Universal joints for hand sockets	154
Scrapers	575	Straight jaw pullers	361	Universal joints for impact sockets	181
Screw extractors	358	Straight oilers	414	Universal tripod	343
Screwdriver socket	144	Straps	460	Universal wrenches	348
Screwdrivers	230	Striking points	310	Utility cart	67
Screwdrivers 1000 V	329	Structural box-end wrenches	222	Utility knives	550
Screwdriving tools	230	Structural wrenches	337	<b>V</b> Valve compressors	388
Screws for extractors	359	S-type hooks	448	Valve lapping tool	392
Scythe stone	560	Suction cups	594	Valve tools	379
Sds max chisels	515	Suspension sockets	396	Vertical cutters	544
Sds plus chisels	515	Swivel chains	447	Vertical oil extractor pumps	417
Security boxes	655	Swivel eye pulley	448	Victor-type chains	446
Security cable	615	Swivel pulleys	451	Vise stands	343
Security safes	655	<b>T</b> Tampers	593	Voltage tester	430
Sensor sockets	383	Tap sets	559	Walking chains	636
Service wrenches	215	Tape dispensers	638	Warning tapes	631
Shackles	449	Tapes	637	Waste oil drain by gravity	381
Shade nets	643	Taps	558	Waterproof padlock set	664
Sharpening stones	560	Tarps	643	Waterproof padlocks	664
Shears	572	Terminal pliers	396	Waterproof ponchos	621
Shelf brackets	641	Tester for gasoline motors	393	Waterproof sandpaper	642
Short combination wrenches	187	T-handle Allen keys	248	Waterproof toolboxes	65
Short L-Shape Allen keys	255	T-handle hexagonal keys	248	Waterproof trench coat	620
Short L-Type hex keys	258	Thermos	698	Welder's kit	604
Short T-handle Allen keys	250	Thimbles	449	Welding helmets	605
Short T-handle hex keys	250	Thirfors	467	Welding lens spare	605
Shovels	590	Thread chaser	387	Wheel tools	377
Sidewalk groover	599	Thread seal tape	640	Wheel weight pliers	379
Silicone tapes	639	Threaders	353	Wheelbarrows	588
Slide hammer pullers	358	Threading die	354	Wheels	468
Sliding t-handles	143	Threading dies	354	Winch straps	460
Slings	457	Thunder torque wrenches	226	Window trolley	687
Slip joint pliers	296	Tie-downs	459	Wire and cable cutter 1000 V	333
Snap ring pliers	283	Tile cutters	594	Wire brushes	540
Snips	305	Tile sets	594	Wire cup brushes	535
Socket clips	93	Tile spacers	596	Wire cutting shears	305
Socket rail and clips	93	Timing-advance testers	390	Wire rope clips	450
Socket rails	93	Tin snips	306	Wire stripper	298
Socket sets and accessories	96	Tire iron	380	Wire utility carts	72
Socket sets and hand accessories	96	Tire wrenches	393	Wire wheel brushes	537
Sockets and accessories 1000 V	327	Tool bags	91	Wood chisels	553
Sockets for removing oil	383	Tool gondola	702	Wood drill bits	518
Sockets with neoprene	387	Tool holder	90	Wood handle flexible putty knives	597
Solid brass padlocks	658	Tool sets	24	Wood sandpaper	642
Spade drill bits	519	Tool sets for mechanics	35	Work center	85
Spare parts for ratchets	153	Tool sets in tool pouch or tote	32	Work stool	343
Spare parts for reversible ratchets	153	Toolboxes	64	Workbench vises	368
Spark plug pliers	387	Top chest with drawers	79	Workbenches	363
Spark plug sockets	387	Torque multipliers	225	Workstation	74
Specialty hammers	322 y 372	Torque screwdrivers	228	Wrenches	184
Specialty tool sets	30	Torque spare parts	225	<b>Y</b> Yellow handle striking screwdrivers	241
Specialty wrenches	214	Torque tools	225	Yoke vises	352
Speed handles	144	Torx bit sockets	123	<b>Z</b> Z-type screwdrivers	243
Spider mesh hoses	583	Torx female sockets	123		
Spiral flute pipe extractors	358	Torx sockets	116		
Spline combination ratcheting wrenches	205	Tow hooks	371		
Spline sockets	134	Tow ropes	371		
Split leather aprons	623	Towing accessories	370		
Split leather gaiters	623	Tpr caster	471		
Splitting axes	570	Trailer balls	370		
Spokeshave	542	Trailer couplers	370		
Spoon tire irons	380	Trailer hook	371		
Sprayers	576	Transfer pump	418		
Spring clamps	366	Transparent tape	637		
Spring compressor	388	Tray for components	45		
Sprinklers	577	Trays	588		
Square drive screwdrivers	144	Tree pruners	569		
Squares	440	Triangular files	554		
Stainless steel straps	636	Trim pad remover	402		
Staples for manual stapler	640	Trimaterial screwdrivers 1000 V	329		
Staples for pneumatic stapler	486	Trolley	467		
Steel drill bits	522	Trowels	598		
Steel drum dollies	454	Truck wheel impact sockets	378		

# FIBERGLASS HANDLE

## WHY IS THE BEST OPTION?



### **MAINTENANCE FREE, EASY TO USE**

Designed for daily work,  
free of additional care.



### **LIGHTER, LESS EFFORT**

Reduces fatigue during long working hours.



### **DURABLE TOOLS, LONGER LIFE**

Comfortable to work with, for greener planet.



### **IDEAL FOR OUTDOORS**

Rust free, neither absorb moisture.



### **MUCH MORE RESISTANT**

Supports strong impacts without  
braking or deforming.



### **MORE PLANET- FRIENDLY**

Each wooden handle involves cutting down a tree.  
Fiberglass reduces environmental impact  
and protects forests.

**CUS26**

**URREA**

SUPERIOR QUALITY AFFORDABLE TOOLS

**SUPERIOR QUALITY**

**URREA**

**SUPERIOR QUALITY**

**usa.urrea.com**

**Phone: (800) 366-6911**

**(210) 734-8703**

**customerservice@urrea.com**

7042 Industrial Way, suite 135 San Antonio, TX, 78252



**PRICE LIST: \$15 USD**

